



böhlerwelding
by voestalpine

Lasting Connections

WF NX 430 SteelDrive

INSTRUCTION MANUAL





Cod. 91.08.544
Date 03/07/2023
Rev. A

ITALIANO.....	1
ENGLISH	39
DEUTSCH.....	79
FRANÇAIS	117
ESPAÑOL.....	155
PORTUGUÊS	193
NEDERLANDS.....	231
SVENSKA	269
DANSK	307
NORSK	345
SUOMI	383
ΕΛΛΗΝΙΚΑ	421

IT

EN

DE

FR

ES

PT

NL

SV

DA

NO

FI

EL

DICHIARAZIONE DI CONFORMITÀ EU

Il costruttore

voestalpine Böhler Welding Selco S.r.l. - Via Palladio, 19 - 35019 Onara di Tombolo (PD) - ITALY
Tel. +39 049 9413/111 - Fax +39 049 9413/311 - www.voestalpine.com/welding

dichiara sotto la propria esclusiva responsabilità che il seguente prodotto:

WF NX 430 STEELDRIVE

71.01.083

è conforme alle direttive EU:

2014/35/EU LOW VOLTAGE DIRECTIVE

2014/30/EU EMC DIRECTIVE

2011/65/EU RoHS DIRECTIVE

e che sono state applicate le norme:

EN IEC 60974-5:2019

WIRE FEEDERS

EN 60974-10/A1:2015

ELECTROMAGNETIC COMPATIBILITY REQUIREMENTS

La documentazione attestante la conformità alle direttive sarà tenuta a disposizione per ispezioni presso il sopraccitato costruttore.

Ogni intervento o modifica non autorizzati dalla voestalpine Böhler Welding Selco S.r.l. faranno decadere la validità di questa dichiarazione.

Onara di Tombolo, 03/07/2023

voestalpine Böhler Welding Selco s.r.l.

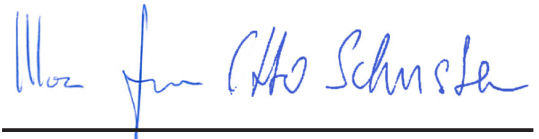

Mirco Frasson

Otto Schuster

Managing Directors

INDICE

1. AVVERTENZE.....	3
1.1 Ambiente di utilizzo	3
1.2 Protezione personale e di terzi	3
1.3 Protezione da fumi e gas	4
1.4 Prevenzione incendio/scoppio.....	4
1.5 Prevenzione nell'uso delle bombole di gas	5
1.6 Protezione da shock elettrico.....	5
1.7 Campi elettromagnetici ed interferenze.....	5
1.8 Grado di protezione IP	6
1.9 Smaltimento.....	6
2. INSTALLAZIONE	6
2.1 Modalità di sollevamento, trasporto e scarico.....	7
2.2 Posizionamento dell'impianto	7
2.3 Allacciamento	7
2.4 Messa in servizio	7
3. PRESENTAZIONE DELL'IMPIANTO.....	9
3.1 Pannello posteriore.....	9
3.2 Pannello prese.....	9
3.3 Pannello comandi frontale.....	10
4. UTILIZZO DELL'IMPIANTO.....	11
4.1 Schermata di avvio.....	11
4.2 Schermata di test	11
4.3 Schermata principale.....	11
5. SETUP.....	15
5.1 Set up e impostazione dei parametri	15
5.2 Procedure specifiche di utilizzo dei parametri	24
6. ACCESSORI	28
7. MANUTENZIONE.....	28
7.1 Controlli periodici	28
7.2 Responsabilità.....	28
8. CODIFICA ALLARMI	29
9. DIAGNOSTICA E SOLUZIONI	30
10. ISTRUZIONI OPERATIVE	33
10.1 Saldatura a filo continuo (MIG/MAG).....	33
11. CARATTERISTICHE TECNICHE	37
12. TARGA DATI.....	38
13. SIGNIFICATO TARGA DATI	38
14. SCHEMA.....	459
15. CONNETTORI.....	460
16. LISTA RICAMBI.....	461
17. INSTALLAZIONE.....	464

SIMBOLOGIA



Pericoli imminenti che causano gravi lesioni e comportamenti rischiosi che potrebbero causare gravi lesioni.



Comportamenti che potrebbero causare lesioni non gravi o danni alle cose.



Le note precedute da questo simbolo sono di carattere tecnico e facilitano le operazioni.

1. AVVERTENZE



Prima di iniziare qualsiasi operazione siate sicuri di aver ben letto e compreso questo manuale. Non apportate modifiche e non eseguite manutenzioni non descritte. Il produttore non si fa carico di danni a persone o cose, occorsi per incuria nella lettura o nella messa in pratica di quanto scritto in questo manuale. Conservare sempre le istruzioni per l'uso sul luogo d'impiego dell'apparecchio. Oltre alle istruzioni per l'uso, attenersi alle norme generali e ai regolamenti locali vigenti in materia di prevenzione degli incidenti e tutela dell'ambiente.



Tutte le persone addette alla messa in funzione, all'utilizzo, alla manutenzione e alla riparazione dell'apparecchio devono

- essere in possesso di apposita qualifica
- disporre delle competenze necessarie in materia di saldatura
- leggere integralmente e osservare scrupolosamente le presenti istruzioni per l'uso.

Per ogni dubbio o problema circa l'utilizzo dell'impianto, anche se qui non descritto, consultare personale qualificato.

1.1 Ambiente di utilizzo



Ogni impianto deve essere utilizzato esclusivamente per le operazioni per cui è stato progettato, nei modi e nei campi previsti in targa dati e/o in questo manuale, secondo le direttive nazionali e internazionali relative alla sicurezza. Un utilizzo diverso da quello espressamente dichiarato dal costruttore è da considerarsi totalmente inappropriato e pericoloso e in tal caso il costruttore declina ogni responsabilità.



Questo apparecchio deve essere usato solo a scopo professionale in un ambiente industriale. Il costruttore non risponderà di danni provocati dall'uso dell'impianto in ambienti domestici.



L'impianto deve essere utilizzato in ambienti con temperatura compresa tra i -10°C e i +40°C (tra i +14°F e i +104°F). L'impianto deve essere trasportato e immagazzinato in ambienti con temperatura compresa tra i -25°C e i +55°C (tra i -13°F e i 131°F).

L'impianto deve essere utilizzato in ambienti privi di polvere, acidi, gas o altre sostanze corrosive.

L'impianto deve essere utilizzato in ambienti con umidità relativa non superiore al 50% a 40°C (104°F).

L'impianto deve essere utilizzato in ambienti con umidità relativa non superiore al 90% a 20°C (68°F).

L'impianto deve essere utilizzato ad una altitudine massima sul livello del mare di 2000m (6500 piedi).



Non utilizzare tale apparecchiatura per scongelare tubi.

Non utilizzare tale apparecchiatura per caricare batterie e/o accumulatori.

Non utilizzare tale apparecchiatura per far partire motori.

1.2 Protezione personale e di terzi



Il processo di saldatura è fonte nociva di radiazioni, rumore, calore ed esalazioni gassose. Sistemare una parete divisoria ignifuga per proteggere la zona di saldatura da raggi, scintille e scorie incandescenti. Avvertire le eventuali terze persone di non fissare con lo sguardo la saldatura e di proteggersi dai raggi dell'arco e dal metallo incandescente.



Indossare indumenti di protezione per proteggere la pelle dai raggi dell'arco e dalle scintille o dal metallo incandescente. Gli indumenti utilizzati devono coprire tutto il corpo e devono essere:

- integri e in buono stato
- ignifughi
- isolanti e asciutti
- aderenti al corpo e privi di risvolti



Utilizzare sempre calzature a normativa, resistenti e in grado di garantire l'isolamento dall'acqua.

Utilizzare sempre guanti a normativa, in grado di garantire l'isolamento elettrico e termico.



Utilizzare maschere con protezioni laterali per il viso e filtro di protezione idoneo (almeno NR10 o maggiore) per gli occhi.



Indossare sempre occhiali di sicurezza con schermi laterali specialmente nell'operazione manuale o meccanica di rimozione delle scorie di saldatura.



Non utilizzare lenti a contatto!



Utilizzare cuffie antirumore se il processo di saldatura diviene fonte di rumorosità pericolosa. Se il livello di rumorosità supera i limiti di legge, delimitare la zona di lavoro ed accertarsi che le persone che vi accedono siano protette con cuffie o auricolari.



Tenere sempre i pannelli laterali chiusi durante le operazioni di saldatura. L'impianto non deve essere sottoposto ad alcun tipo di modifica. Evitare il contatto tra mani, capelli, indumenti, attrezzi... e parti in movimento quali: ventilatori, ruote dentate, rulli e alberi, bobine di filo. Non operare sulle ruote dentate quando il trainafilo è in funzione. L'esclusione dei dispositivi di protezione sulle unità di avanzamento del filo è estremamente pericoloso e solleva il costruttore da ogni responsabilità su danni a cose e persone.



Tenere la testa lontano dalla torcia MIG/MAG durante il caricamento e l'avanzamento del filo. Il filo in uscita può provocare seri danni alle mani, al viso e agli occhi.



Evitare di toccare i pezzi appena saldati, l'elevato calore potrebbe causare gravi ustioni o scottature. Mantenere tutte le precauzioni precedentemente descritte anche nelle lavorazioni post saldatura in quanto, dai pezzi lavorati che si stanno raffreddando, potrebbero staccarsi scorie.



Assicurarsi che la torcia si sia raffreddata prima di eseguire lavorazioni o manutenzioni.



Assicurarsi che il gruppo di raffreddamento sia spento prima di sconnettere i tubi di mandata e ritorno del liquido refrigerante. Il liquido caldo in uscita potrebbe causare gravi ustioni o scottature.



Provvedere ad un'attrezzatura di pronto soccorso. Non sottovalutare scottature o ferite.



Prima di lasciare il posto di lavoro, porre in sicurezza l'area di competenza in modo da impedire danni accidentali a cose o persone.

1.3 Protezione da fumi e gas



Fumi, gas e polveri prodotti dal processo di saldatura possono risultare dannosi alla salute. I fumi prodotti durante il processo di saldatura possono, in determinate circostanze, provocare il cancro o danni al feto nelle donne in gravidanza.

- Tenere la testa lontana dai gas e dai fumi di saldatura.
- Prevedere una ventilazione adeguata, naturale o forzata, nella zona di lavoro.
- In caso di aerazione insufficiente utilizzare maschere dotate di respiratori.
- Nel caso di saldature in ambienti angusti è consigliata la sorveglianza dell'operatore da parte di un collega situato esternamente.
- Non usare ossigeno per la ventilazione.
- Verificare l'efficacia dell'aspirazione controllando periodicamente l'entità delle emissioni di gas nocivi con i valori ammessi dalle norme di sicurezza.
- La quantità e la pericolosità dei fumi prodotti è riconducibile al materiale base utilizzato, al materiale d'apporto e alle eventuali sostanze utilizzate per la pulizia e lo sgrassaggio dei pezzi da saldare. Seguire attentamente le indicazioni del costruttore e le relative schede tecniche.
- Non eseguire operazioni di saldatura nei pressi di luoghi di sgrassaggio o verniciatura.
- Posizionare le bombole di gas in spazi aperti o con un buon ricircolo d'aria.

1.4 Prevenzione incendio/scoppio



Il processo di saldatura può essere causa di incendio e/o scoppio.

- Sgomberare dalla zona di lavoro e circostante i materiali o gli oggetti infiammabili o combustibili.
- I materiali infiammabili devono trovarsi ad almeno 11 metri (35 piedi) dalla zona di lavoro o devono essere opportunamente protetti.
- Le proiezioni di scintille e di particelle incandescenti possono facilmente raggiungere le zone circostanti anche attraverso piccole aperture. Porre particolare attenzione nella messa in sicurezza di cose e persone.
- Non eseguire saldature sopra o in prossimità di recipienti in pressione.
- Non eseguire operazioni di saldatura su recipienti o tubi chiusi. Porre comunque particolare attenzione nella saldatura di tubi o recipienti anche nel caso questi siano stati aperti, svuotati e accuratamente puliti. Residui di gas, carburante, olio o simili potrebbe causare esplosioni.
- Non saldare in atmosfera contenente polveri, gas o vapori esplosivi.
- Accertarsi, a fine lavoro, che il circuito in tensione non possa accidentalmente toccare parti collegate al circuito di massa.
- Predisporre nelle vicinanze della zona di lavoro un'attrezzatura o un dispositivo antincendio.

1.5 Prevenzione nell'uso delle bombole di gas



Le bombole di gas inerte contengono gas sotto pressione e possono esplodere nel caso non vengano assicurate le condizioni minime di trasporto, mantenimento e uso.

- Le bombole devono essere vincolate verticalmente a pareti o ad altro, con mezzi idonei, per evitare cadute o urti meccanici accidentali.
- Avvitare il cappuccio a protezione della valvola durante il trasporto, la messa in servizio e ogni qualvolta le operazioni di saldatura siano terminate.
- Evitare che le bombole siano esposte direttamente ai raggi solari e a sbalzi elevati di temperatura. Non esporre le bombole a temperature troppo rigide o troppo alte.
- Evitare che le bombole entrino in contatto con fiamme libere, con archi elettrici, con torce o pinze porta elettrodo, con le proiezioni incandescenti prodotte dalla saldatura.
- Tenere le bombole lontano dai circuiti di saldatura e dai circuiti di corrente in genere.
- Tenere la testa lontano dal punto di fuoriuscita del gas quando si apre la valvola della bombola.
- Chiudere sempre la valvola della bombola quando le operazioni di saldatura sono terminate.
- Non eseguire mai saldature su una bombola di gas in pressione.
- Non collegare mai una bombola di aria compressa direttamente al riduttore della macchina! La pressione potrebbe superare la capacità del riduttore che quindi potrebbe esplodere!

1.6 Protezione da shock elettrico



Uno shock da scarica elettrica può essere mortale.

- Evitare di toccare parti normalmente in tensione interne o esterne all'impianto di saldatura mentre l'impianto stesso è alimentato (torce, pinze, cavi massa, elettrodi, fili, rulli e bobine sono elettricamente collegati al circuito di saldatura).
- Assicurare l'isolamento elettrico dell'impianto e dell'operatore utilizzando piani e basamenti asciutti e sufficientemente isolati dal potenziale di terra e di massa.
- Assicurarsi che l'impianto venga allacciato correttamente ad una spina e ad una rete provvista del conduttore di protezione a terra.
- Non toccare contemporaneamente due torce o due pinze portaelettrodo.
- Interrompere immediatamente le operazioni di saldatura se si avverte la sensazione di scossa elettrica.

1.7 Campi elettromagnetici ed interferenze



Il passaggio della corrente attraverso i cavi interni ed esterni all'impianto, crea un campo elettromagnetico nelle immediate vicinanze dei cavi e dell'impianto stesso.

- I campi elettromagnetici possono avere effetti (ad oggi sconosciuti) sulla salute di chi ne subisce una esposizione prolungata.
- I campi elettromagnetici possono interferire con altre apparecchiature quali pace-maker o apparecchi acustici.



I portatori di apparecchiature elettroniche vitali (pace-maker) devono consultare il medico prima di avvicinarsi alle operazioni di saldatura ad arco.

1.7.1 Classificazione EMC in accordo con la norma: EN 60974-10/A1:2015.

Classe
B

L'apparecchiatura di Classe B è conforme con i requisiti di compatibilità elettromagnetica in ambienti industriali e residenziali, incluse aree residenziali dove l'energia elettrica è fornita da un sistema pubblico a bassa tensione.

Classe
A

L'apparecchiatura di Classe A non è intesa per l'uso in aree residenziali dove l'energia elettrica è fornita da un sistema pubblico a bassa tensione. Può essere potenzialmente difficile assicurare la compatibilità elettromagnetica di apparecchiature di classe A in questi aree, a causa di disturbi irradiati e condotti.

Per maggiori informazioni consultare: TARGA DATI o CARATTERISTICHE TECNICHE.

1.7.2 Installazione, uso e valutazione dell'area

Questo apparecchio è costruito in conformità alle indicazioni contenute nella norma armonizzata: EN 60974-10/A1:2015 ed è identificato come di "CLASSE A". Questo apparecchio deve essere usato solo a scopo professionale in un ambiente industriale. Il costruttore non risponderà di danni provocati dall'uso dell'impianto in ambienti domestici.



L'utilizzatore deve essere un esperto del settore ed in quanto tale è responsabile dell'installazione e dell'uso dell'apparecchio secondo le indicazioni del costruttore. Qualora vengano rilevati dei disturbi elettromagnetici, spetta all'utilizzatore dell'apparecchio risolvere la situazione avvalendosi dell'assistenza tecnica del costruttore.



In tutti i casi i disturbi elettromagnetici devono essere ridotti fino al punto in cui non costituiscono più un fastidio.



Prima di installare questo apparecchio, l'utilizzatore deve valutare i potenziali problemi elettromagnetici che si potrebbero verificare nell'area circostante e in particolare la salute delle persone circostanti, per esempio: utilizzatori di pace-maker e di apparecchi acustici.

1.7.3 Precauzioni riguardo i cavi

Per minimizzare gli effetti dei campi elettromagnetici, seguire le seguenti regole:

- Arrotolare insieme e fissare, dove possibile, cavo massa e cavo potenza.
- Evitare di arrotolare i cavi intorno al corpo.
- Evitare di fraporsi tra il cavo di massa e il cavo di potenza (tenere entrambi dallo stesso lato).
- I cavi devono essere tenuti più corti possibile e devono essere posizionati vicini e scorrere su o vicino il livello del suolo.
- Posizionare l'impianto ad una certa distanza dalla zona di lavoro.
- I cavi devono essere posizionati lontano da eventuali altri cavi presenti.

1.7.4 Collegamento equipotenziale

Il collegamento a massa di tutti i componenti metallici nell'impianto di saldatura e nelle sue vicinanze deve essere preso in considerazione. Rispettare le normative nazionali riguardanti il collegamento equipotenziale.

1.7.5 Messa a terra del pezzo in lavorazione

Dove il pezzo in lavorazione non è collegato a terra, per motivi di sicurezza elettrica o a causa della dimensione e posizione, un collegamento a massa tra il pezzo e la terra potrebbe ridurre le emissioni. Bisogna prestare attenzione affinché la messa a terra del pezzo in lavorazione non aumenti il rischio di infortunio degli utilizzatori o danneggi altri apparecchi elettrici. Rispettare le normative nazionali riguardanti la messa a terra.

1.7.6 Schermatura

La schermatura selettiva di altri cavi e apparecchi presenti nell'area circostante può alleviare i problemi di interferenza. La schermatura dell'intero impianto di saldatura può essere presa in considerazione per applicazioni speciali.

1.8 Grado di protezione IP



IP23S

- Involucro protetto contro l'accesso a parti pericolose con un dito e contro corpi solidi estranei di diametro maggiore o uguale a 12,5 mm.
- Involucro protetto contro pioggia a 60° sulla verticale.
- Involucro protetto dagli effetti dannosi dovuti all'ingresso d'acqua, quando le parti mobili dell'apparecchiatura non sono in moto.

1.9 Smaltimento



Non collocare l'apparecchiatura elettrica tra i normali rifiuti!

In osservanza alla Direttiva Europea 2012/19/EU sui Rifiuti di Apparecchiature Elettriche ed Elettroniche e alla sua implementazione in accordo con le leggi nazionali, le apparecchiature elettriche che hanno raggiunto la fine del ciclo di vita devono essere raccolte separatamente e inviate ad un centro di recupero e smaltimento. Il proprietario dell'apparecchiatura dovrà identificare i centri di raccolta autorizzati informandosi presso le Amministrazioni Locali. L'applicazione della Direttiva Europea permetterà di migliorare l'ambiente e la salute umana.

» Per maggiori informazioni consultare il sito.

2. INSTALLAZIONE



L'installazione può essere effettuata solo da personale esperto ed abilitato dal produttore.



Per l'installazione assicurarsi che il generatore sia scollegato dalla rete di alimentazione.

2.1 Modalità di sollevamento, trasporto e scarico

- L'impianto è provvisto di un manico che ne permette la movimentazione a mano.
- L'impianto non è provvisto di elementi specifici per il sollevamento.
- Utilizzare un elevatore a forche ponendo la massima attenzione nello spostamento, al fine di evitare il ribaltamento del generatore.



Non sottovalutare il peso dell'impianto, vedi caratteristiche tecniche.
 Non far transitare o sostare il carico sospeso sopra a persone o cose.
 Non lasciare cadere o appoggiare con forza l'impianto o la singola unità.

2.2 Posizionamento dell'impianto



Osservare le seguenti norme:

- Facile accesso ai comandi ed ai collegamenti.
- Non posizionare l'attrezzatura in ambienti angusti.
- Non posizionare mai l'impianto su di un piano con inclinazione maggiore di 10° dal piano orizzontale.
- Collocare l'impianto in un luogo asciutto, pulito e con ventilazione appropriata.
- Proteggere l'impianto contro la pioggia battente e contro il sole.

2.3 Allacciamento





Le unità mobili sono alimentate esclusivamente a bassa tensione.

2.4 Messa in servizio

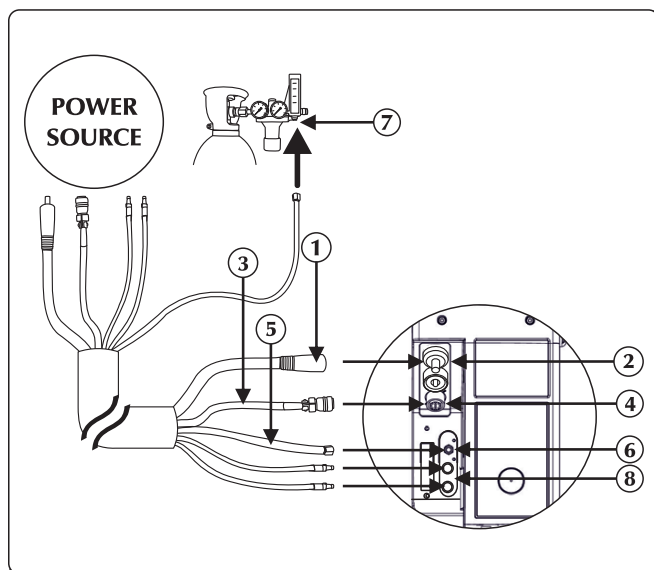
2.4.1 Collegamento per saldatura MIG/MAG



- ① Cavo potenza
- ② Presa positiva di potenza (+)
- ③ Cavo segnale
- ④ Ingresso cavo di segnale
- ⑤ Tubo gas
- ⑥ Raccordo-innesto gas
- ⑦ Raccordo alimentazione gas
- ⑧ Innesto liquido refrigerante

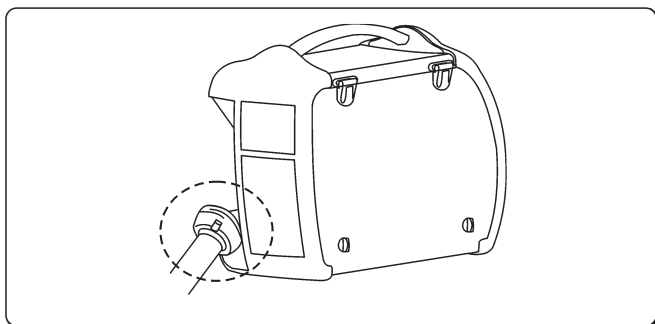

- ▶ Collegare il cavo di potenza del fascio cavi all'apposita presa. Inserire la spina e ruotare in senso orario fino al completo fissaggio delle parti.
- ▶ Collegare il cavo di segnale del fascio cavi all'apposito connettore. Inserire il connettore e ruotare la ghiera in senso orario fino al completo fissaggio delle parti.
- ▶ Collegare il tubo gas del fascio cavi al riduttore di pressione della bombola o al raccordo di alimentazione del gas. Regolare il flusso gas da 10 a 30 l/min.
- ▶ Collegare il tubo di mandata liquido refrigerante del fascio cavi (colore blu) all'apposito raccordo/innesto  (colore blu).
- ▶ Collegare il tubo di ritorno liquido refrigerante del fascio cavi (colore rosso) all'apposito raccordo/innesto  (colore rosso).
- ▶ Collegare il cavo di segnale CAN-BUS per la gestione di dispositivi esterni (quali RC, RI...) all'apposito connettore.

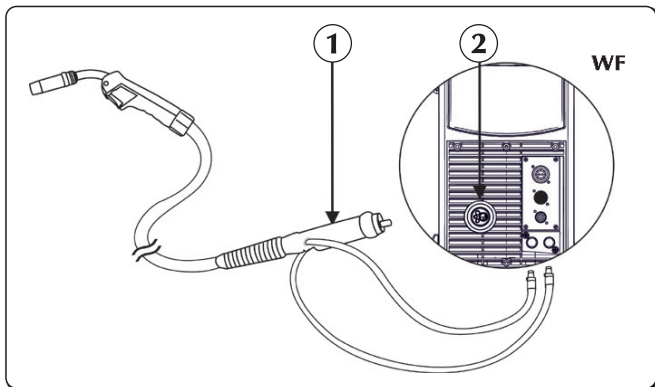

Consultare la sezione "Installazione accessori".



- ① Attacco torcia
- ② Connettore

- ▶ Collegare il tubo di ritorno liquido refrigerante della torcia (colore rosso) all'apposito raccordo/innesto  (colore rosso).
- ▶ Collegare il tubo di mandata liquido refrigerante della torcia (colore blu) all'apposito raccordo/innesto  (colore blu).
- ▶ Collegare la torcia MIG/MAG sull'attacco, prestando particolare attenzione nell'avvitare completamente la ghiera di fissaggio.

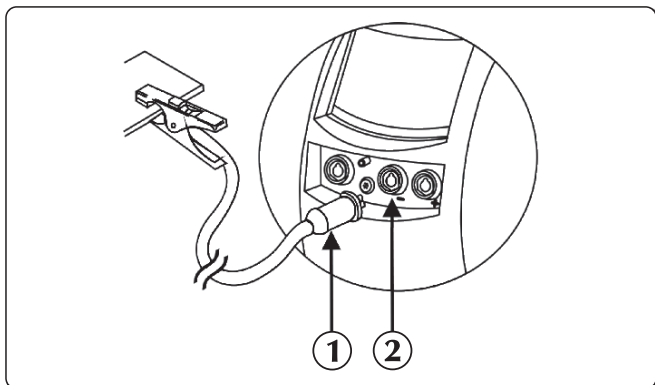

- ① Connettore pinza massa
- ② Presa negativa di potenza (-)

- ▶ Collegare il connettore del cavo della pinza di massa alla presa negativa (-) del generatore. Inserire la spina e ruotare in senso orario fino al completo fissaggio delle parti.

Vano motore

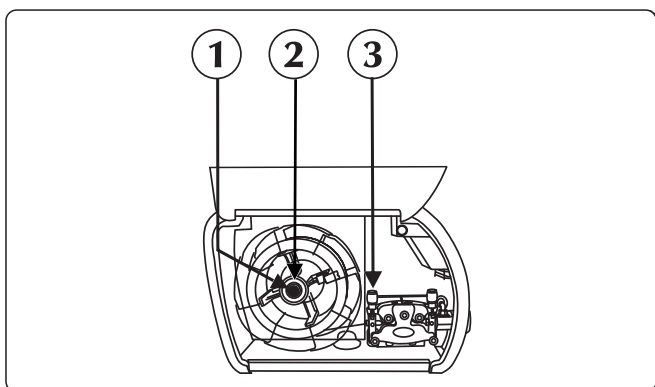

- ① Ghiera
- ② Vite frizione
- ③ Supporto traino

- ▶ Aprire il cofano laterale destro.
- ▶ Controllare che la gola del rullino coincida con il diametro del filo che si desidera utilizzare.
- ▶ Svitare la ghiera dall'aspo porta rocchetto e inserire il rocchetto.
- ▶ Fare entrare in sede anche il perno dell'aspo, inserire la bobina, rimettere la ghiera in posizione e registrare la vite di frizione.

- ▶ Sbloccare il supporto traino del motoriduttore infilando il capo del filo nella boccola guidafile e, facendolo passare sul rullino, nell'attacco torcia. Bloccare in posizione il supporto traino controllando che il filo sia entrato nella gola dei rullini.
- ▶ Premere il pulsante di avanzamento filo per caricare il filo nella torcia.
- ▶ Regolare il flusso gas da 10 a 30 l/min.

3. PRESENTAZIONE DELL'IMPIANTO

3.1 Pannello posteriore

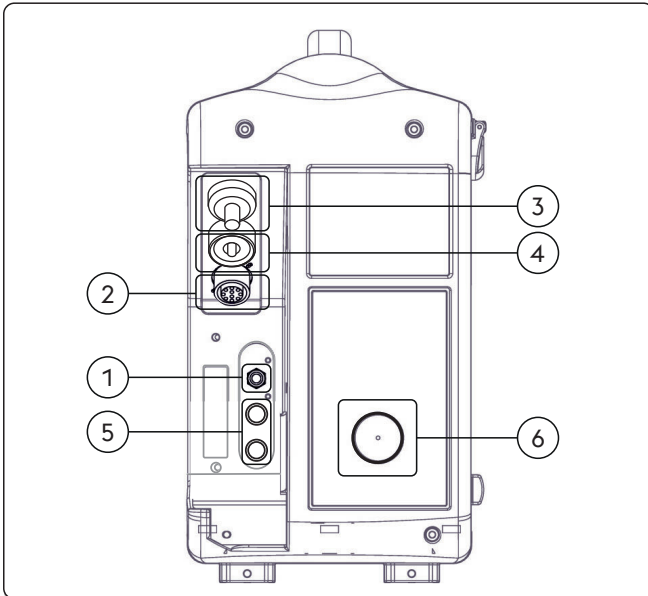

- ① Attacco gas
- ② Ingresso cavo di segnale (CAN-BUS) (Fascio cavi)
- ③ Ingresso cavo di potenza (Fascio cavi)
- ④ Presa positiva di potenza (+)
- ⑤ Ingresso/uscita liquido di raffreddamento
- ⑥ Ingresso filo

3.2 Pannello prese

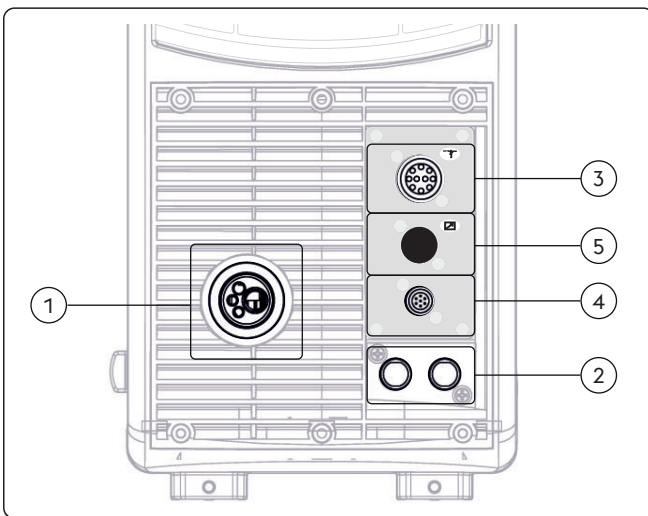





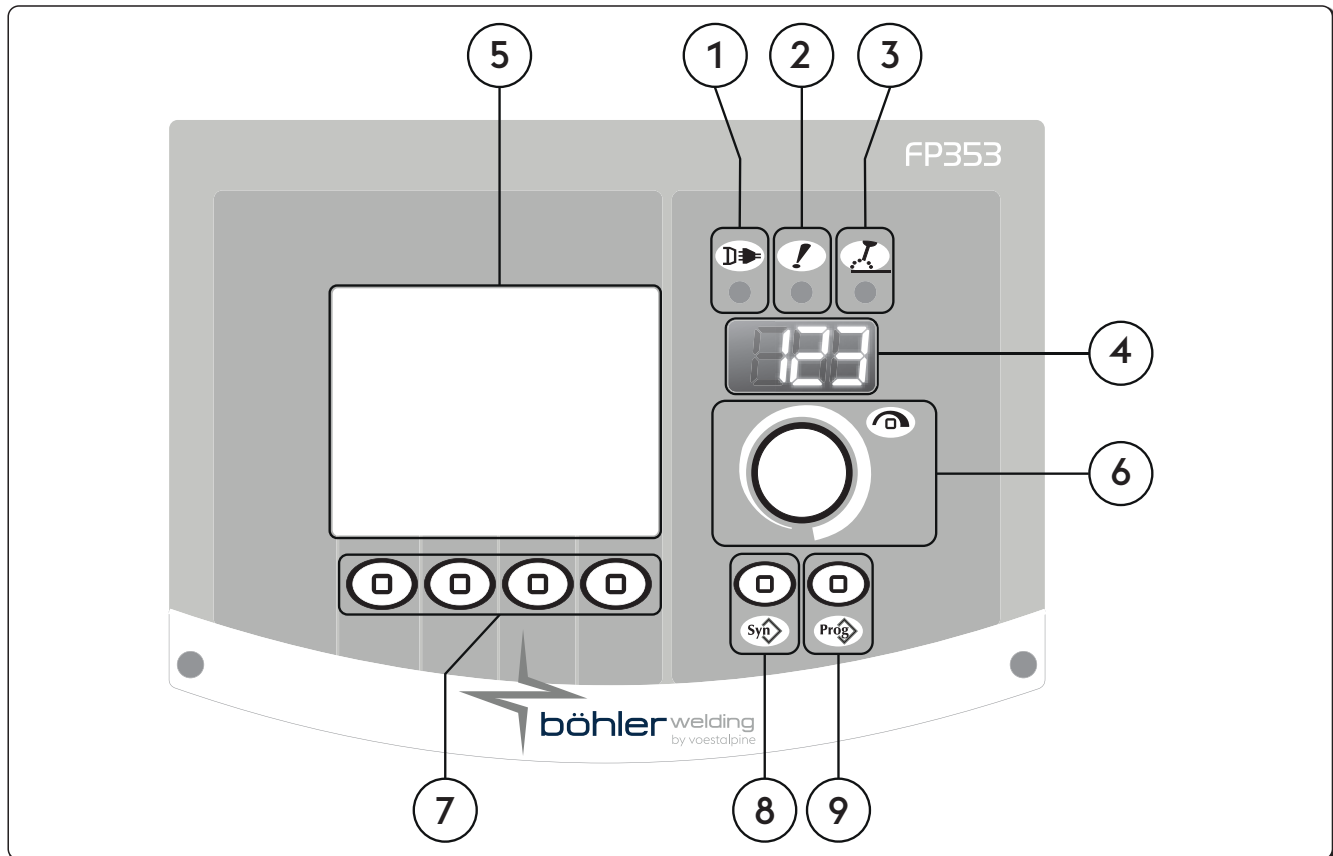

- ① Attacco torcia
Permette la connessione della torcia MIG/MAG.
- ② Innesto liquido refrigerante
- ③ Ingresso cavo di segnale (Push-Pull)
- ④ Ingresso cavo di segnale (Torcia)
Connessione torcia
- ⑤ Ingresso cavo di segnale (RC)

3.3 Pannello comandi frontale

IT



- ①  **LED di alimentazione**
Indica che l'impianto è collegato alla rete elettrica e che è alimentato.
- ②  **LED di allarme generale**
Indica l'eventuale intervento dei dispositivi di protezione quali la protezione termica.
- ③  **LED di potenza attiva**
Indica la presenza di tensione sulle prese d'uscita dell'impianto.
- ④  **Display a 7 segmenti**
Permette di visualizzare le generalità della saldatrice in fase di partenza, le impostazioni e le letture di corrente e di tensione in saldatura, la codifica degli allarmi.
- ⑤  **Display LCD**
Permette di visualizzare le generalità della saldatrice in fase di partenza, le impostazioni e le letture di corrente e di tensione in saldatura, la codifica degli allarmi.
Permette di visualizzare istantaneamente tutte le operazioni.
- ⑥  **Manopola di regolazione principale**
Permette l'ingresso a set up, la selezione e l'impostazione dei parametri di saldatura.
- ⑦  **Tasti funzione**
Permettono la selezione delle varie funzionalità dell'impianto:
- Processo di saldatura
- Modalità di saldatura
- Pulsazione di corrente
- Modalità grafica

8 Tasto programmi di saldatura

Permette la selezione di un programma di saldatura preimpostato attraverso la selezione di alcune semplici informazioni:

- Tipo di filo
- Tipo di gas
- Diametro filo

9 Tasto job

4. UTILIZZO DELL'IMPIANTO

4.1 Schermata di avvio

All'accensione, l'impianto esegue una serie di verifiche atte a garantirne il corretto funzionamento ed anche di tutti i dispositivi ad esso connessi. In questa fase viene anche eseguito il test gas per accertare il corretto allacciamento al sistema di alimentazione del gas.

4.2 Schermata di test

Quando il pannello laterale (vano bobina) è aperto, le operazioni di saldatura vengono inibite. Sul display LCD compare la schermata di test.

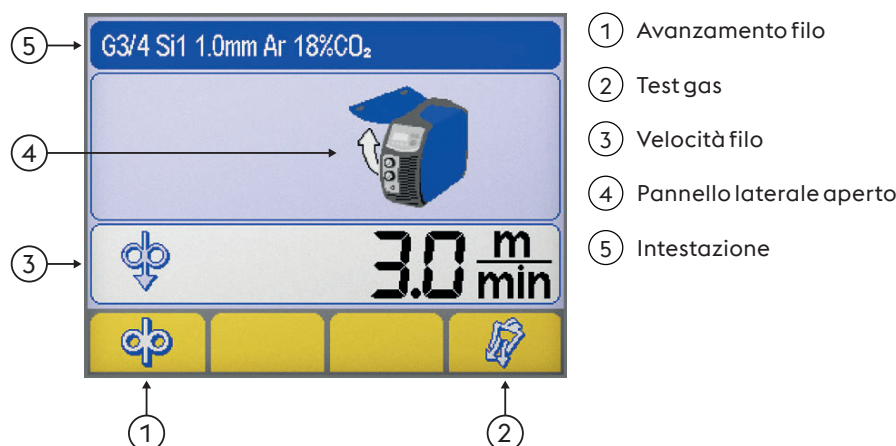

Avanzamento filo

Permette l'avanzamento manuale del filo senza flusso gas e senza che il filo sia in tensione. Consente l'inserimento del filo nella guaina della torcia durante le fasi di preparazione alla saldatura.



Test gas

Permette di liberare da impurità il circuito del gas e di eseguire, senza potenza in uscita, le opportune regolazioni preliminari di pressione e portata del gas.



Velocità avanzamento filo

Permette la regolazione della velocità di avanzamento del filo (durante la fase di caricamento).

Minimo	Massimo	Default
0.5 m/min	22.0 m/min	3.0 m/min



Pannello laterale aperto



Intestazione

Permette la visualizzazione di alcune importanti informazioni relative al processo selezionato.

4.3 Schermata principale

Permette la gestione dell'impianto e del processo di saldatura, mostrando le impostazioni principali.

4.4 Schermata principale processo MIG/MAG

IT

Schermata base

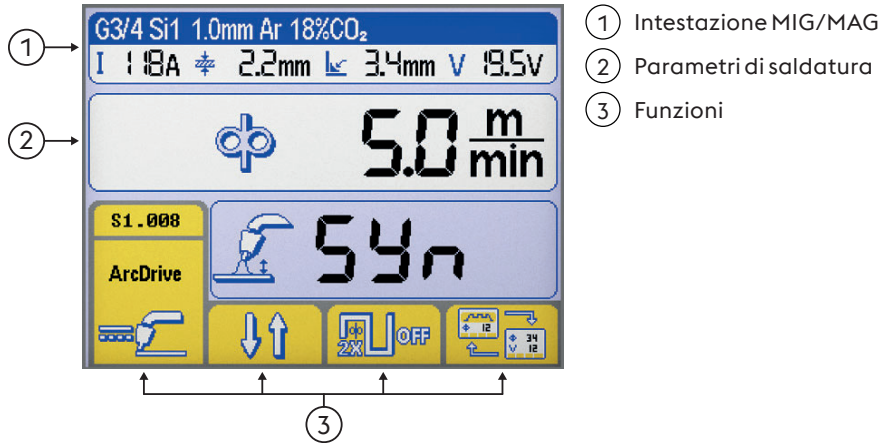

Schermata grafica

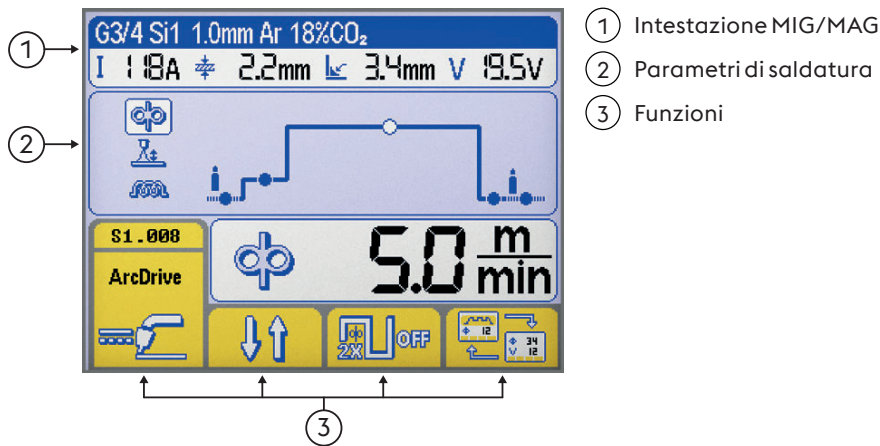

Intestazione MIG/MAG

Permette la visualizzazione di alcune importanti informazioni relative al processo selezionato.

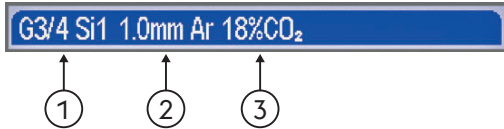

Curva sinergica selezionata

- ① Tipo di materiale d'apporto
- ② Diametro filo
- ③ Tipo di gas

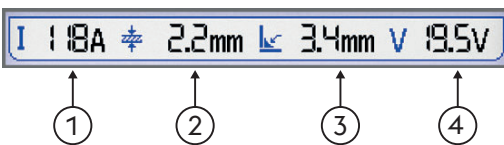

Parametri di saldatura

- ① Corrente di saldatura
- ② Spessore pezzo
- ③ Cordone d'angolo "a"
- ④ Tensione di saldatura

Parametri di saldatura (Schermata base)

► Selezionare il parametro desiderato premendo il tasto encoder.

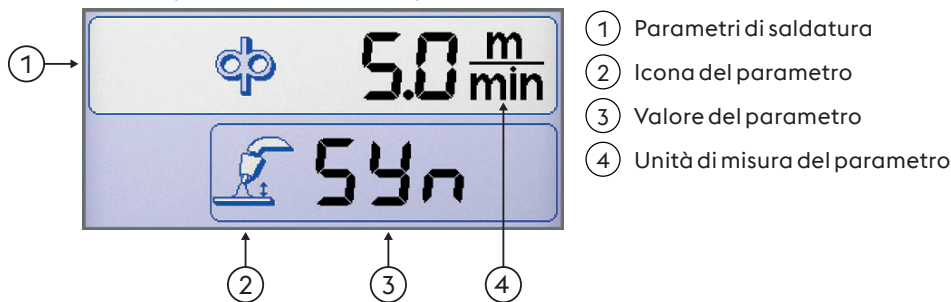

Parametri di saldatura (Schermata grafica)

► Selezionare il parametro desiderato premendo il tasto encoder.

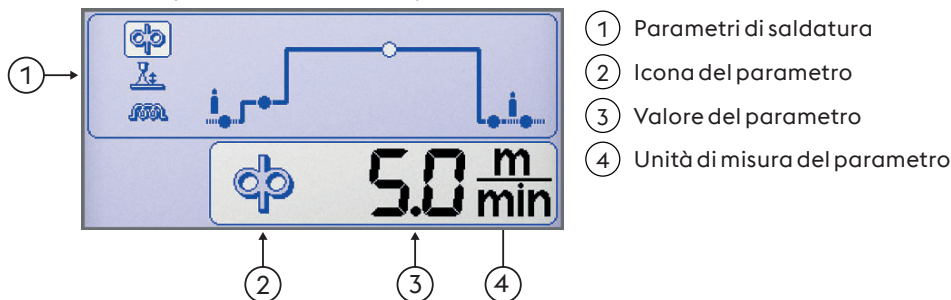

Funzioni

Permettono l'impostazione delle funzionalità di processo e delle modalità di saldatura più importanti.

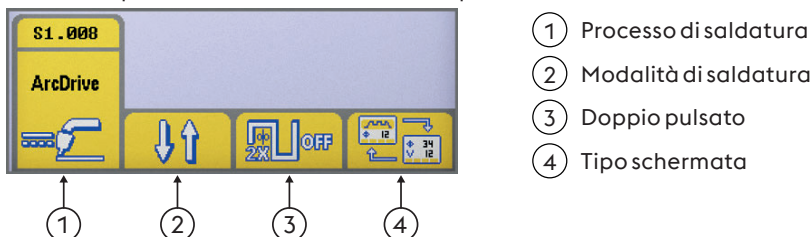

Modalità di saldatura

Consente la selezione della modalità di saldatura



2 Tempi

In due tempi la pressione del pulsante fa fluire il gas, attiva la tensione sul filo e lo fa avanzare; al rilascio il gas, la tensione e l'avanzamento del filo vengono tolti.



4 Tempi

In quattro tempi la prima pressione del pulsante fa fluire il gas effettuando un pre gas manuale, al rilascio viene attivata la tensione sul filo e il suo avanzamento. La successiva pressione del pulsante blocca il filo e fa iniziare il processo finale che porta la corrente a zero, il rilascio definitivo del pulsante toglie l'afflusso del gas.



Crater filler

Permette di eseguire una saldatura con tre diversi livelli di potenza selezionabili e gestibili direttamente dal saldatore attraverso il pulsante torcia.

La prima pressione del pulsante torcia fa fluire il gas, attiva la tensione sul filo e lo fa avanzare alla velocità impostata nel parametro "incremento iniziale" (a set up) e con i relativi valori sinergici dei parametri di saldatura.

Al rilascio del pulsante torcia, la velocità del filo e i relativi parametri sinergici passano automaticamente ai valori principali impostati sul pannello comandi.

La successiva pressione del pulsante torcia porta la velocità filo e i relativi parametri sinergici ai valori preimpostati nel parametro (a set up) crater filler.

Il rilascio del pulsante torcia, blocca l'avanzamento del filo e l'erogazione della potenza eseguendo burn back e post gas.



Doppio pulsato



Doppio pulsato attivo



Doppio pulsato non attivo

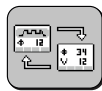

Tipo schermata

Permette il cambio di visualizzazione tra:



Schermata base



Schermata grafica

Schermata curve sinergiche



Sinergia

Permette la selezione di un programma di saldatura preimpostato (sinergia) attraverso la selezione di alcune semplici informazioni

Selezione processo di saldatura

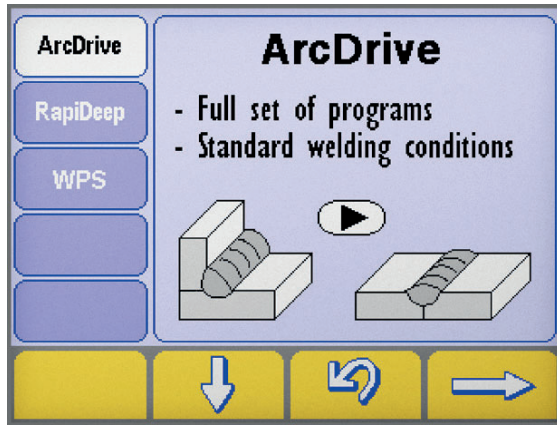

- ▶ Entrare nella schermata "sinergie" premendo il tasto per almeno un secondo.
- ▶ Selezionare il processo desiderato premendo i tasti e .
- ▶ Premere il pulsante per passare allo step successivo.

IT



Schermata selezione sinergia Tipo materiale/Tipo gas

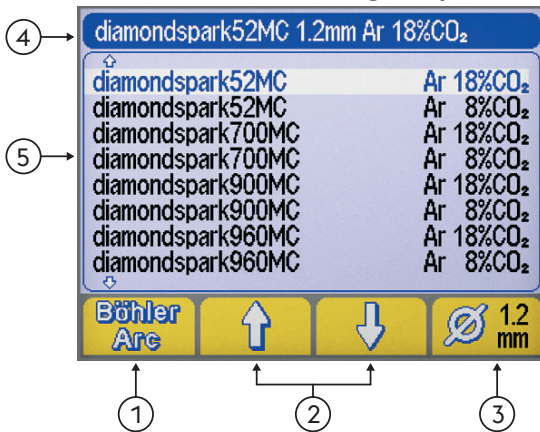

- 1 Programma di saldatura (BöhlerArc/UniversalArc)
- 2 Selezione materiale/gas
- 3 Diametro filo
- 4 Intestazione
- 5 Programma di saldatura

Böhler Arc Programma di saldatura
 Consente la selezione del programma di saldatura

Böhler Arc BöhlerArc **Univers. Arc** UniversalArc

↑ Selezione materiale/gas
 Permette la selezione di:

- Tipo di materiale d'apporto
- Tipo di gas

Diametro filo

Permette la selezione del diametro del filo utilizzato (mm).

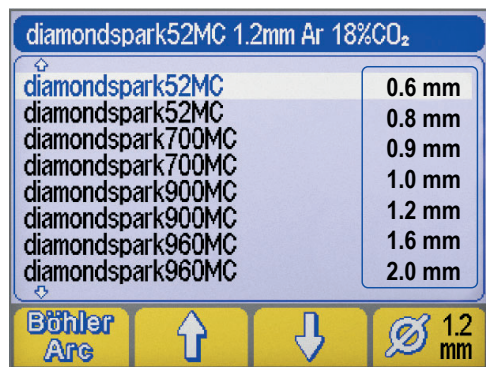

① Diametro filo

①

Intestazione

Permette la visualizzazione di alcune importanti informazioni relative al processo selezionato.

NO PROGRAM

Indica che la curva sinergica selezionata non è disponibile o non è coerente con le altre impostazioni dell'impianto.

5. SETUP

5.1 Set up e impostazione dei parametri

Permette l'impostazione e la regolazione di una serie di parametri aggiuntivi per una migliore e più precisa gestione dell'impianto di saldatura.

I parametri presenti a set up sono organizzati in relazione al processo di saldatura selezionato e hanno una codifica numerica.



Ingresso a set up

- ▶ Avviene premendo per 5 secondi il tasto encoder.
- ▶ L'entrata sarà confermata dalla scritta 0 sul display.

Selezione e regolazione del parametro desiderato

- ▶ Avviene ruotando l'encoder fino a visualizzare il codice numerico relativo al parametro desiderato.
- ▶ La pressione del tasto encoder, a questo punto, permette la visualizzazione del valore impostato per il parametro selezionato e la sua regolazione.

Uscita da set up

- ▶ Per uscire dalla sezione "regolazione" premere nuovamente l'encoder.
- ▶ Per uscire dal set up portarsi sul parametro "0" (salva ed esci) e premere l'encoder.
- ▶ Annullare l'operazione premendo il tasto .
- ▶ Per salvare la modifica ed uscire dal set up premere il tasto: .

5.1.1 Elenco parametri a set up (MMA)

0

Salva ed esci

Permette di salvare le modifiche e di uscire dal set up.

Save & Exit

1

Reset

Permette di reimpostare tutti i parametri ai valori di default.

Res

3

Hot start

Permette la regolazione del valore di hot start in MMA.

Consente una partenza più o meno "calda" nelle fasi d'innesco dell'arco facilitando di fatto le operazioni di start.



Elettrodo Basico

Minimo	Massimo	Default
0/off	500%	80%

Elettrodo Cellulosico

Minimo	Massimo	Default
0/off	500%	150%

Elettrodo CrNi

Minimo	Massimo	Default
0/off	500%	100%

Elettrodo Alluminio

Minimo	Massimo	Default
0/off	500%	120%

Elettrodo Cast Iron

Minimo	Massimo	Default
0/off	500%	100%

7

Corrente di saldatura

Permette la regolazione della corrente di saldatura.



Minimo	Massimo	Default
3 A	I _{max}	100 A

8

Arc force

Permette la regolazione del valore dell'Arc force in MMA.

Consente una risposta dinamica più o meno energetica in saldatura facilitando di fatto le operazioni del saldatore.



Aumentare il valore dell'Arc force per ridurre i rischi di incollamento dell'elettrodo.

Elettrodo Basico

Minimo	Massimo	Default
0/off	500%	30%

Elettrodo Cellulosico

Minimo	Massimo	Default
0/off	500%	350%

Elettrodo CrNi

Minimo	Massimo	Default
0/off	500%	30%

Elettrodo Alluminio

Minimo	Massimo	Default
0/off	500%	100%

Elettrodo Cast Iron

Minimo	Massimo	Default
0/off	500%	70%

204

Dynamic power control (DPC)

Permette la selezione della caratteristica V/I desiderata.



I=C Corrente costante

L'aumento o la riduzione dell'altezza dell'arco non ha alcuna incidenza sulla corrente di saldatura erogata.

Consigliato per elettrodo: Basico, Rutilico, Acido, Acciaio, Ghisa

1÷20 Caratteristica cadente con regolazione di rampa

L'aumento dell'altezza dell'arco provoca la riduzione della corrente di saldatura (e viceversa) secondo il valore impostato da 1 a 20 Ampere per ogni Volt.

Consigliato per elettrodo: Cellulosico, Alluminio

P=C Potenza costante

L'aumento dell'altezza dell'arco provoca la riduzione della corrente di saldatura (e viceversa) secondo la legge: $V \cdot I = K$

Consigliato per elettrodo: Cellulosico, Alluminio

312 Tensione di stacco arco

Permette di impostare il valore di tensione al quale viene forzato lo spegnimento dell'arco elettrico. Consente di gestire al meglio le varie condizioni operative che si vengono a creare.

In fase di puntatura, per esempio, una bassa tensione di stacco d'arco permette una minore sfiammata nell'allontanamento dell'elettrodo dal pezzo riducendo spruzzi, bruciature e ossidazione del pezzo. Se si utilizzano elettrodi che richiedono alte tensioni è invece consigliabile impostare una soglia alta per evitare spegnimenti d'arco durante la saldatura.



Non impostare mai una tensione di stacco arco maggiore della tensione a vuoto del generatore.

Elettrodo Basico

Minimo	Massimo	Default
0/off	99.9 V	57.0 V

Elettrodo Cellulosico

Minimo	Massimo	Default
0/off	99.9 V	70.0 V

399 Velocità di spostamento

Permette l'impostazione della velocità di esecuzione della saldatura. Default cm/min: velocità di riferimento per la saldatura manuale. Syn: valore sinergico.

Minimo	Massimo	Default
1 cm/min	200 cm/min	15 cm/min

500 Impostazione macchina

Permette la selezione dell'interfaccia grafica desiderata. Permette di accedere ai livelli superiori del set up. Consultare la sezione "Personalizzazione interfaccia (Set up 500)".

Valore	Interfaccia Utente	Valore	Livello selezionato
XE	Modalità Easy	USER	Utente
XA	Modalità Advanced	SERV	Service
XP	Modalità Professional	vaBW	vaBW

551 Lock/unlock

Permette il blocco dei comandi del pannello e l'inserzione di un codice di protezione. Consultare la sezione "Lock/unlock (Set up 551)".

552 Tono cicalino

Permette la regolazione del tono del cicalino.

Minimo	Massimo	Default
0/off	10	10

601 Passo di regolazione

Permette la regolazione di un parametro con passo personalizzabile dall'operatore.

Minimo	Massimo	Default
1	Imax	1

602 Parametro esterno CH1, CH2, CH3, CH4

Permette la gestione del parametro esterno 1, 2, 3, 4 (valore minimo, valore massimo, valore di default, parametro selezionato). Consultare la sezione "Gestione comandi esterni (Set up 602)".

705 Taratura resistenza circuito

Permette la taratura dell'impianto. Consultare la sezione "Taratura resistenza circuito (set up 705)".

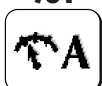
751 Lettura di corrente

Permette la visualizzazione del valore reale della corrente di saldatura.

752

Letture di tensione

Permette la visualizzazione del valore reale della tensione di saldatura.



768

Misura apporto termico HI

Permette la lettura del valore della misura dell'apporto termico in saldatura.



801

Limiti di guardia

Permette l'impostazione dei limiti di attenzione e dei limiti di guardia.

Permette di controllare il processo di saldatura impostando sui principali parametri misurabili limiti di attenzione e limiti di guardia.

Consente il controllo accurato delle varie fasi di saldatura.

Consultare la sezione "Limiti di guardia (Set up 801)".



5.1.2 Elenco parametri a set up (TIG)

0

Salva ed esci

Permette di salvare le modifiche e di uscire dal set up.



1

Reset

Permette di reimpostare tutti i parametri ai valori di default.



7

Corrente di saldatura

Permette la regolazione della corrente di saldatura.



Minimo	Massimo	Default
3 A	I _{max}	100 A

399

Velocità di spostamento

Permette l'impostazione della velocità di esecuzione della saldatura.

Default cm/min: velocità di riferimento per la saldatura manuale.

Syn: valore sinergico.



Minimo	Massimo	Default
1 cm/min	200 cm/min	10 cm/min

500

Impostazione macchina

Permette la selezione dell'interfaccia grafica desiderata.

Permette di accedere ai livelli superiori del set up.

Consultare la sezione "Personalizzazione interfaccia (Set up 500)"



Valore	Interfaccia Utente	Valore	Livello selezionato
XE	Modalità Easy	USER	Utente
XA	Modalità Advanced	SERV	Service
XP	Modalità Professional	vaBW	vaBW

551

Lock/unlock

Permette il blocco dei comandi del pannello e l'inserzione di un codice di protezione.

Consultare la sezione "Lock/unlock (Set up 551)".



552

Tono cicalino

Permette la regolazione del tono del cicalino.



Minimo	Massimo	Default
0/off	10	10

601

Passo di regolazione

Permette la regolazione di un parametro con passo personalizzabile dall'operatore.



Minimo	Massimo	Default
1	I _{max}	1

- 602 Parametro esterno CH1, CH2, CH3, CH4**
 Permette la gestione del parametro esterno 1, 2, 3, 4 (valore minimo, valore massimo, valore di default, parametro selezionato).
 Consultare la sezione "Gestione comandi esterni (Set up 602)".
- 705 Taratura resistenza circuito**
 Permette la taratura dell'impianto.
 Consultare la sezione "Taratura resistenza circuito (set up 705)".
- 751 Lettura di corrente**
 Permette la visualizzazione del valore reale della corrente di saldatura.
- 752 Lettura di tensione**
 Permette la visualizzazione del valore reale della tensione di saldatura.
- 758 Velocità di spostamento robot**
 Permette la visualizzazione della velocità di spostamento del braccio di un robot o di una automazione.
- 768 Misura apporto termico HI**
 Permette la lettura del valore della misura dell'apporto termico in saldatura.
- 801 Limiti di guardia**
 Permette l'impostazione dei limiti di attenzione e dei limiti di guardia.
 Permette di controllare il processo di saldatura impostando sui principali parametri misurabili limiti di attenzione e limiti di guardia.
 Consente il controllo accurato delle varie fasi di saldatura.
 Consultare la sezione "Limiti di guardia (Set up 801)".

5.1.3 Elenco parametri a set up (MIG/MAG)

- 0 Salva ed esci**
 Permette di salvare le modifiche e di uscire dal set up.
- 1 Reset**
 Permette di reimpostare tutti i parametri ai valori di default.
- 2 Programmi di saldatura**
- MIG/MAG Standard:**
 Permette la selezione del processo MIG manuale (Off) o MIG sinergico (6) impostando il tipo di materiale da saldare.
- MIG/MAG Pulsato:**
 Permette la selezione del processo MIG sinergico (6) impostando il tipo di materiale da saldare.
 Permette la selezione del processo CC/CV.
- 3 Velocità filo**
 Permette la regolazione della velocità di avanzamento del filo.
- | Minimo | Massimo | Default |
|-----------|------------|---------|
| 0.5 m/min | 22.0 m/min | - |
- 4 Corrente**
 Permette la regolazione della corrente di saldatura.
- | Minimo | Massimo |
|--------|------------------|
| 3 A | I _{max} |

5 Spessore pezzo



Permette l'impostazione dello spessore del pezzo da saldare.
Consente l'impostazione dell'impianto attraverso la regolazione del pezzo da saldare.

6 Cordone d'angolo "a"



Permette l'impostazione della profondità del cordone in un giunto d'angolo.

10 Pre gas



Permette di impostare e regolare il flusso di gas prima dell'innesco dell'arco.
Consente il caricamento del gas in torcia e la preparazione dell'ambiente per la saldatura.

Minimo	Massimo	Default
0/off	99.9 s	0.1 s

11 Soft start



Permette la regolazione della velocità di avanzamento del filo nelle fasi che precedono l'innesco.
Consente un innesco a velocità ridotta e pertanto più morbido e con meno spruzzi.

Minimo	Massimo	Default
10 %	100 %	50 %

12 Rampa motore



Permette di impostare un passaggio graduale tra la velocità filo d'innesco e quella di saldatura.

Minimo	Massimo	Default
0/off	1.0 s	0/off

15 Burn back



Permette la regolazione del tempo di bruciatura del filo impedendo l'incollamento a fine saldatura.
Consente di regolare la lunghezza del pezzo di filo esterno alla torcia.

Minimo	Massimo	Default
-2.00	+2.00	0/syn

16 Post gas



Permette di impostare e regolare il flusso di gas a fine saldatura.

Minimo	Massimo	Default
0/off	99.9 s	2.0 s

19 Duty cycle (doppio pulsato)



Permette la regolazione del duty cycle in doppio pulsato.

Minimo	Massimo	Default
10 %	90 %	50 %

20 Doppio pulsato



Permette la regolazione dell'ampiezza della pulsazione.

Minimo	Massimo	Default
0 %	100 %	±25 %

Minimo	Massimo	Default
0.5 m/min	22 m/min	2.5 m/min

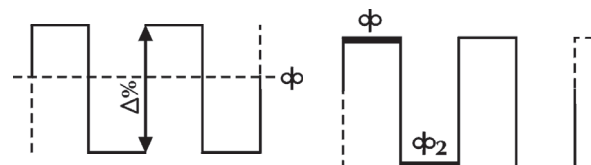

21 Frequenza di pulsazione (doppio pulsato)



Permette la regolazione del periodo, cioè del ciclo di ripetizione della pulsazione.
Consente di regolare la frequenza dell'impulso.

Minimo	Massimo	Default
0.1 Hz	5.0 Hz	2.0 Hz

22 Tensione secondaria (doppio pulsato)

Permette la regolazione della tensione del livello di pulsazione secondario.
Consente di ottenere una maggiore stabilità d'arco nelle varie fasi di pulsazione.

Minimo	Massimo	Default
-5.0	+5.0	0/syn

23 Rampe pulsato (doppio pulsato)

Permette l'impostazione di un tempo di rampa nella fase di pulsazione.

Minimo	Massimo	Default
1 %	100 %	50 %

24 Bilevel (4T - crater filler)

Permette la regolazione della velocità filo secondaria nella modalità di saldatura bilevel.

Se il saldatore preme e rilascia velocemente il pulsante si passa ad “ ϕ_2 ”.

Premendo e rilasciando velocemente il pulsante si passa nuovamente ad “ ϕ ” e così via.

Minimo	Massimo	Default
1 %	200 %	0/off

25 Incremento iniziale

Permette di regolare il valore della velocità filo durante la prima fase di saldatura del "crater-filler".

Consente di incrementare l'energia fornita al pezzo nella fase in cui il materiale (ancora freddo) necessita di maggior calore per fondere in modo omogeneo.

Minimo	Massimo	Default
20 %	200 %	120 %

26 Crater filler

Permette di regolare il valore della velocità filo durante la fase di chiusura della saldatura.

Consente di ridurre l'energia fornita al pezzo nella fase in cui il materiale è già molto caldo, riducendo i rischi di inutili deformazioni.

Minimo	Massimo	Default
20 %	200 %	80 %

27 Temporizzazione incremento iniziale

Permette l'impostazione del tempo di incremento iniziale.

Consente di automatizzare la funzione "crater filler".

Minimo	Massimo	Default
0.1 s	99.9 s	0/off

28 Temporizzazione crater filler

Permette l'impostazione del tempo di "crater filler".

Consente di automatizzare la funzione "crater filler".

Minimo	Massimo	Default
0.1 s	99.9 s	0/off

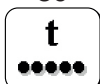
30 Puntatura

Permette di abilitare il processo "puntatura" e di stabilire il tempo di saldatura.

Minimo	Massimo	Default
0.1 s	99.9 s	0/off

31 Punto pausa

Permette di abilitare il processo "punto pausa" e di stabilire il tempo di sosta tra una saldatura e l'altra.

Minimo	Massimo	Default
0.1 s	99.9 s	0/off

32 Tensione secondaria (Bilevel MIG)



Permette la regolazione della tensione del livello di pulsazione secondario.
Consente di ottenere una maggiore stabilità d'arco nelle varie fasi di pulsazione.

Minimo	Massimo	Default
-5.0	+5.0	0/syn

33 Induttanza secondaria (Bilevel MIG)



Permette la regolazione dell'induttanza del livello di pulsazione secondario.
Consente di ottenere un arco più o meno rapido nella compensazione dei movimenti del saldatore e della naturale instabilità di saldatura.

Induttanza bassa = arco reattivo (maggiori spruzzi).
Induttanza alta = arco poco reattivo (spruzzi ridotti).

Minimo	Massimo	Default
-30	+30	0/syn

34 Rampa incremento iniziale



Permette di impostare un passaggio graduale tra l'incremento iniziale e la saldatura.

Minimo	Massimo	Default
0 s	10 s	0/off

35 Rampa crater filler



Permette di impostare un passaggio graduale tra la saldatura e il crater filler.

Minimo	Massimo	Default
0 s	10 s	0/off

202 Induttanza



Permette una regolazione elettronica dell'induttanza serie del circuito di saldatura.
Consente di ottenere un arco più o meno rapido nella compensazione dei movimenti del saldatore e della naturale instabilità di saldatura.

Induttanza bassa = arco reattivo (maggiori spruzzi).
Induttanza alta = arco poco reattivo (spruzzi ridotti).

Minimo	Massimo	Default
-30	+30	0/syn

331 Tensione media compensata



Permette l'impostazione della tensione di saldatura.

398 Costante di riferimento velocità di spostamento



Costante di riferimento per tutti i processi di saldatura
Valore della velocità di spostamento della torcia alla quale il sistema si riferisce per eseguire i calcoli dei parametri di saldatura

399 Velocità di spostamento



Permette l'impostazione della velocità di esecuzione della saldatura.
Default cm/min: velocità di riferimento per la saldatura manuale.
Syn: valore sinergico.

Minimo	Massimo	Default
syn min	syn max	35 cm/min

500 Impostazione macchina



Permette la selezione dell'interfaccia grafica desiderata.
Permette di accedere ai livelli superiori del set up.
Consultare la sezione "Personalizzazione interfaccia (Set up 500)"

Valore	Interfaccia Utente
XE	Modalità Easy
XA	Modalità Advanced
XP	Modalità Professional

Valore	Livello selezionato
USER	Utente
SERV	Service
vaBW	vaBW

551 Lock/unlock

Permette il blocco dei comandi del pannello e l'inserzione di un codice di protezione.
 Consultare la sezione "Lock/unlock (Set up 551)".

552 Tono cicalino

Permette la regolazione del tono del cicalino.

Minimo	Massimo	Default
0/off	10	10

601 Passo di regolazione

Permette la regolazione di un parametro con passo personalizzabile dall'operatore.
 Funzionalità controllabile tramite pulsante up/down della torcia.

Minimo	Massimo	Default
1	Imax	1

602 Parametro esterno CH1, CH2, CH3, CH4

Permette la gestione del parametro esterno 1, 2, 3, 4 (valore minimo, valore massimo, valore di default, parametro selezionato).

Consultare la sezione "Gestione comandi esterni (Set up 602)".

606 Torcia U/D

Permette la gestione del parametro esterno (U/D).

Valore	Default	Funzione Richiamata
0/off	-	off
1/I1	X	Corrente
	-	Richiamo programmi

612 Setting Torcia DgMig

Permette la gestione dei canali della torcia digitale.

Valore	Default	Funzione Richiamata
0/off	-	off
1/I1	-	Corrente
2/ 	-	Richiamo programmi
3/CH3	-	CH3
4/CH4	-	CH4
5/STD	X	STD

653 Velocità avanzamento filo

Permette la regolazione della velocità di avanzamento del filo (durante la fase di caricamento).

Minimo	Massimo	Default
0.5 m/min	22.0 m/min	3.0 m/min

705 Taratura resistenza circuito

Permette la taratura dell'impianto.

Consultare la sezione "Taratura resistenza circuito (set up 705)".

751 Lettura di corrente

Permette la visualizzazione del valore reale della corrente di saldatura.

752 Lettura di tensione

Permette la visualizzazione del valore reale della tensione di saldatura.

755 **Letture di portata gas**
 Permette la visualizzazione del valore reale del flusso gas.



757 **Letture velocità filo**
 Lettura encoder motore 1.



758 **Velocità di spostamento robot**
 Permette la visualizzazione della velocità di spostamento del braccio di un robot o di una automazione.



760 **Letture di corrente (motore 1)**
 Permette la visualizzazione del valore reale della corrente (motore 1).



768 **Misura apporto termico HI**
 Permette la lettura del valore della misura dell'apporto termico in saldatura.



770 **Misura del tasso di deposito**
 Permette la visualizzazione della misura del tasso di deposito.



801 **Limiti di guardia**
 Permette l'impostazione dei limiti di attenzione e dei limiti di guardia.
 Permette di controllare il processo di saldatura impostando sui principali parametri misurabili limiti di attenzione e limiti di guardia.
 Consente il controllo accurato delle varie fasi di saldatura.
 Consultare la sezione "Limiti di guardia (Set up 801)".





5.2 Procedure specifiche di utilizzo dei parametri

5.2.1 Personalizzazione display 7 segmenti

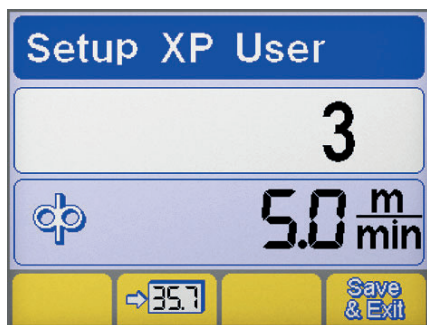
Permette di visualizzare costantemente il valore di un parametro sul display 7 segmenti.



- ▶ Entrare nel set up premendo il tasto encoder per almeno 5 secondi.
- ▶ Selezionare il parametro desiderato ruotando l'encoder.
- ▶ Memorizzare il parametro selezionato nel display 7 segmenti premendo il tasto .
- ▶ Salvare ed uscire dalla schermata corrente premendo il tasto .

5.2.2 Personalizzazione interfaccia (Set up 500)

Permette di personalizzare i parametri nella schermata principale.

500 **Impostazione macchina**
 Permette la selezione dell'interfaccia grafica desiderata.



Valore	Interfaccia Utente
XE	Modalità Easy
XA	Modalità Advanced
XP	Modalità Professional

MODALITÀ XE

MIG/MAG	
Parametri di saldatura	
Funzioni	

MODALITÀ XA

MIG/MAG	
Parametri di saldatura	
Funzioni	

MODALITÀ XP

MIG/MAG	
Parametri di saldatura	
Funzioni	

5.2.3 Lock/unlock (Set up 551)

Permette il blocco dei comandi del pannello e l'inserimento di un codice di protezione.

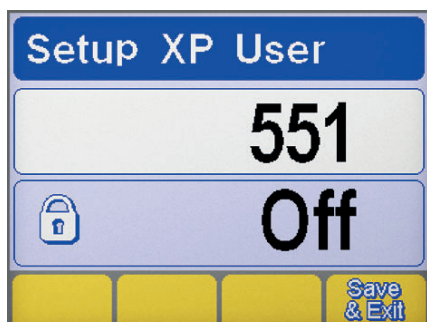
Selezione parametro

- ▶ Entrare nel set up premendo il tasto encoder per almeno 5 secondi.
- ▶ Selezionare il parametro desiderato (551).
- ▶ Attivare la regolazione del parametro selezionato premendo il tasto encoder.

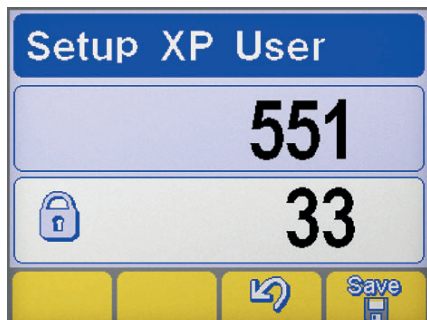
Impostazione password

- ▶ Impostare una codifica numerica (password) ruotando l'encoder.
- ▶ Confermare l'operazione premendo il tasto-encoder.
- ▶ Annullare l'operazione premendo il tasto .
- ▶ Per salvare la modifica premere il pulsante: .

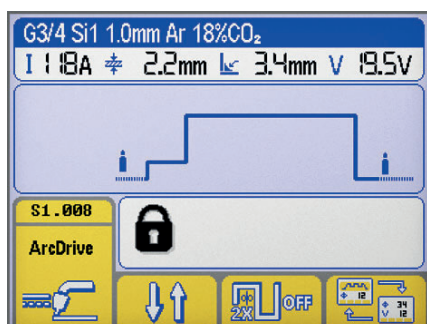
Funzioni pannello

- ▶ Accedere temporaneamente (5 minuti) alle funzionalità del pannello ruotando l'encoder ed inserendo il corretto codice numerico.
- ▶ Confermare l'operazione premendo il tasto-encoder.
- ▶ Sbloccare definitivamente il pannello comandi entrando nel set up (seguire le indicazioni precedentemente descritte) e riportare il parametro 551 a "off".
- ▶ Confermare l'operazione premendo il tasto-encoder.
- ▶ Per salvare la modifica premere il pulsante: .

5.2.4 Gestione comandi esterni (Set up 602)

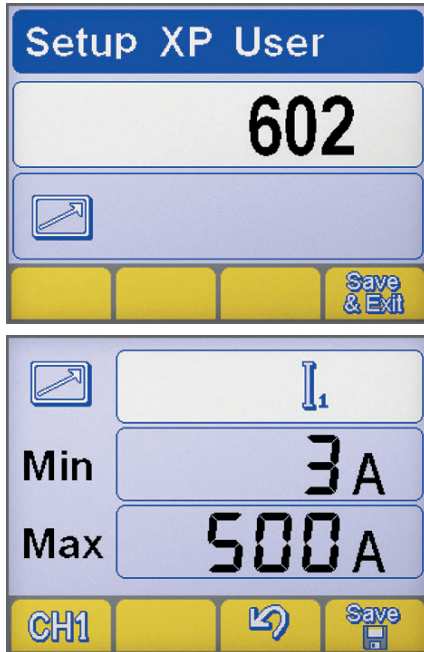

Permette la gestione del parametro esterno 2 (valore minimo, valore massimo, valore di default, parametro selezionato).



Selezione parametro

- ▶ Entrare nel set up premendo il tasto encoder per almeno 5 secondi.
- ▶ Selezionare il parametro desiderato (602).
- ▶ Entrare nella schermata "Gestione comandi esterni" premendo il tasto encoder.

Gestione comandi esterni

- ▶ Selezionare l'uscita di controllo RC desiderata (CH1, CH2, CH3, CH4) premendo il tasto **CH1**.
- ▶ Selezionare il parametro desiderato (Min-Max-parametro) premendo il tasto encoder.
- ▶ Regolare il parametro desiderato (Min-Max-parametro) ruotando l'encoder.
- ▶ Per salvare la modifica premere il pulsante: .
- ▶ Annullare l'operazione premendo il tasto .

5.2.5 Taratura resistenza circuito (set up 705)



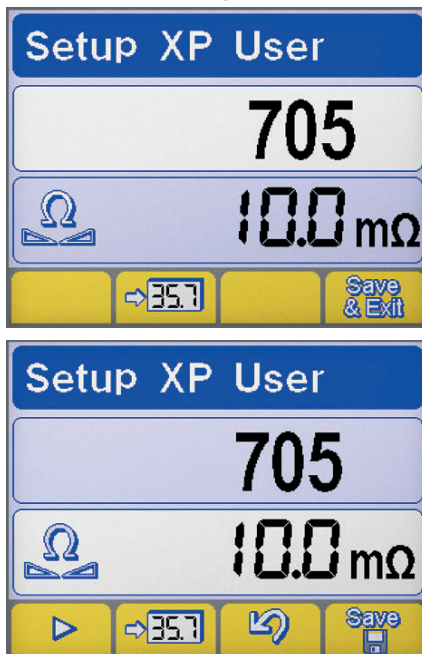

Consente di tarare il generatore sulla resistenza del circuito di saldatura attuale.



Selezione parametro

- ▶ Entrare nel set up premendo il tasto encoder per almeno 5 secondi.
- ▶ Selezionare il parametro desiderato (705).
- ▶ Attivare la regolazione del parametro selezionato premendo il tasto encoder.
- ▶ Collegare il generatore al circuito di saldatura (banco o pezzo).
- ▶ Togliere il cappuccio per mettere il tip porta ugello della torcia esposto. (MIG/MAG)

Taratura

- ▶ Mettere in contatto elettrico la punta guidafile ed il pezzo da saldare. (MIG/MAG)
- ▶ Premere il pulsante  per iniziare la procedura.
- ▶ Tenere il contatto per almeno un secondo.
- ▶ Il valore visualizzato a display si aggiornerà a taratura eseguita.
- ▶ Confermare l'operazione premendo il tasto .
- ▶ Annullare l'operazione premendo il tasto .
- ▶ Per salvare la modifica ed uscire dal set up premere il tasto: .

5.2.6 Limiti di guardia (Set up 801)

Permette l'impostazione dei limiti di attenzione e dei limiti di guardia.

Permette di controllare il processo di saldatura impostando sui principali parametri misurabili limiti di attenzione e limiti di guardia.

Consente il controllo accurato delle varie fasi di saldatura.

Consultare la sezione "Limiti di guardia (Set up 801)".

Limiti di attenzione	⚠ MIN	⚠ MAX	Limiti di guardia	⚠ MIN	⚠ MAX
Corrente di saldatura			Tensione di saldatura		
Lettura di portata gas			Velocità di spostamento robot		
Lettura di corrente (motore 1)			Lettura di corrente (motore 2)		
Lettura flusso liquido refrigerante			Lettura velocità filo		
Lettura di temperatura liquido refrigerante					

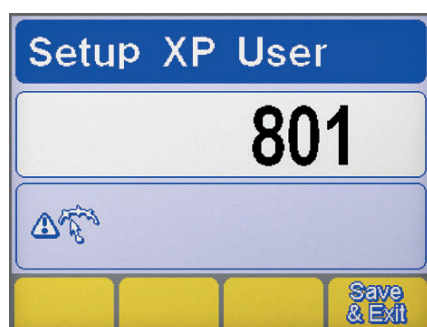

Selezione parametro

- ▶ Entrare nel set up premendo il tasto encoder per almeno 5 secondi.
- ▶ Selezionare il parametro desiderato (801).
- ▶ Entrare nella schermata "Limiti di guardia" premendo il tasto encoder.

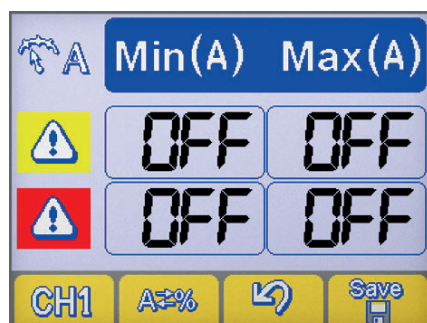

Selezione del parametro

- ▶ Selezionare il parametro desiderato premendo il tasto **CH1**.
- ▶ Selezionare la modalità d'impostazione dei limiti di guardia premendo il tasto **A=%**.

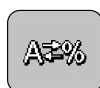

Selezione modalità



Valore assoluto



Valore percentuale

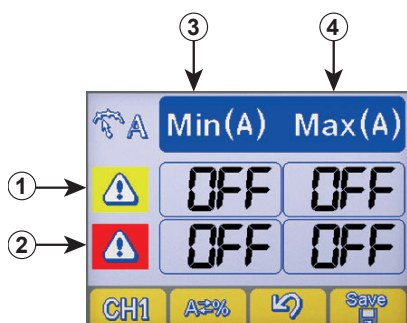

Impostazione limiti di guardia

- ① Riga dei limiti di attenzione
- ② Riga dei limiti di allarme
- ③ Colonna dei livelli minimi
- ④ Colonna dei livelli massimi

- ▶ Selezionare la casella desiderata premendo il tasto encoder (la casella selezionata viene visualizzata con contrasto invertito).
- ▶ Regolare il livello del limite selezionato ruotando l'encoder.
- ▶ Per salvare la modifica premere il pulsante:



Il superamento di uno dei limiti di attenzione causa una segnalazione visiva sul pannello comandi.



Il superamento di uno dei limiti di allarme causa una segnalazione visiva sul pannello comandi e il blocco immediato delle operazioni di saldatura.



È consentito impostare dei filtri di inizio e fine saldatura per evitare segnalazioni di errore nelle fasi di innesco e di chiusura dell'arco (consultare sezione "Set up" - Parametri 802-803-804).

6. ACCESSORI

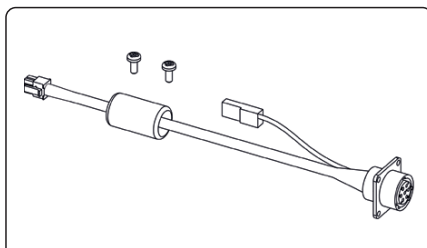

Kit RC (WF... Steeldrive)
73.11.015

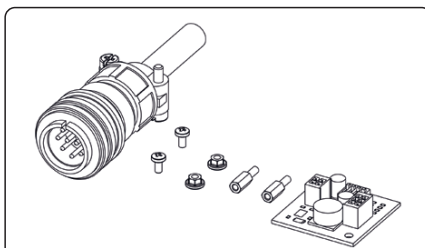

Kit Push-Pull
73.11.012

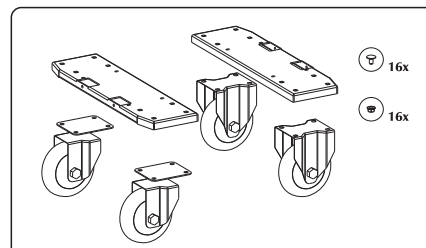

Kit ruote grandi trainafilo
73.10.073

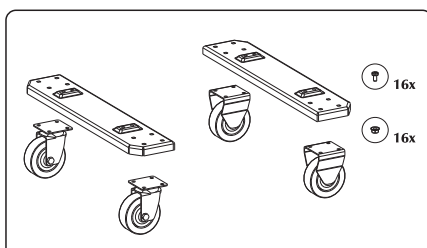

Kit ruote piccole trainafilo
73.10.074

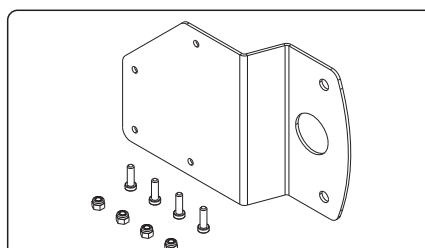

Kit supporto trainafilo
73.10.075

*Montaggio in fabbrica

Consultare sezione "Installazione kit/accessori".

7. MANUTENZIONE



L'impianto deve essere sottoposto ad una manutenzione ordinaria secondo le indicazioni del costruttore. Tutti gli sportelli di accesso e servizio e i coperchi devono essere chiusi e ben fissati quando l'apparecchio è in funzione. L'impianto non deve essere sottoposto ad alcun tipo di modifica. Evitare che si accumuli polvere metallica in prossimità e sulle alette di areazione.



L'eventuale manutenzione deve essere eseguita esclusivamente da personale qualificato. La riparazione o la sostituzione di parti dell'impianto da parte di personale non autorizzato comporta l'immediata invalidazione della garanzia del prodotto. L'eventuale riparazione o sostituzione di parti dell'impianto deve essere eseguita esclusivamente da personale tecnico qualificato.



Togliere l'alimentazione all'impianto prima di ogni intervento!

7.1 Controlli periodici



Effettuare la pulizia interna utilizzando aria compressa a bassa pressione e pennelli a setola morbida. Controllare le connessioni elettriche e tutti i cavi di collegamento.

7.2 Responsabilità

























































In mancanza di detta manutenzione, decadono tutte le garanzie e comunque il costruttore viene sollevato da qualsiasi responsabilità. Nel caso l'operatore non si attenesse a quanto descritto, il costruttore declina ogni responsabilità. Per ogni dubbio e/o problema non esitare a consultare il più vicino centro di assistenza tecnica.

8. CODIFICA ALLARMI

ALLARME
 L'intervento di un allarme o il superamento di un limite di guardia critico causa una segnalazione visiva sul pannello comandi ed il blocco immediato delle operazioni di saldatura.

ATTENZIONE
 Il superamento di un limite di guardia causa una segnalazione visiva sul pannello comandi ma consente di continuare le operazioni di saldatura.

Di seguito sono elencati tutti gli allarmi e i tutti i limiti di guardia relativi all'impianto.

 E01	Sovratemperatura		 E02	Sovratemperatura	
 E05	Sovracorrente		 E07	Anomalia sistema di alimentazione del motore trainafile	
 E08	Motore bloccato		 E10	Sovracorrente modulo di potenza (Inverter)	
 E12.1	Errore di comunicazione WF1		 E13	Errore di comunicazione (FP)	
 E14.xx	Programma non valido il sotto codice dell'errore indica il numero del job eliminato		 E15	Programma non valido	
 E16.1	Errore di comunicazione RI 1000/2000/3000 (CAN bus)		 E16.2	Errore di comunicazione RI 3000 (Modbus)	
 E16.3	Errore di comunicazione RI 1000/2000		 E18.xx	Programma non valido il sotto codice dell'errore indica il numero del job eliminato	
 E19	Errore configurazione impianto		 E19.1	Errore configurazione impianto	
 E19.11	Errore configurazione impianto (WF)		 E20	Memoria guasta	
 E21	Perdita dati		 E23	Programmi di saldatura non presenti	
 E27	Memoria guasta (RTC)		 E32	Perdita dati	
 E33.1	Errore configurazione impianto (LCD 3.5")		 E33.3	Errore di comunicazione (ACTIVATION KEY)	
 E33.4	Errore di comunicazione (ACTIVATION KEY)		 E40	Anomalia alimentazione impianto	
 E43	Mancanza liquido refrigerante		 E44	Mancanza gas	

E48	Mancanza filo (automazione e robotica)		E50	Filo incollato (automazione e robotica)	
E54	Livello di corrente superato (Limite inferiore)		E55	Livello di corrente superato (Limite superiore)	
E56	Livello di tensione superato (Limite inferiore)		E57	Livello di tensione superato (Limite superiore)	
E58	Livello di flusso gas superato (Limite inferiore)		E59	Livello di flusso gas superato (Limite superiore)	
E62	Livello di corrente superato (Limite inferiore)		E63	Livello di corrente superato (Limite superiore)	
E64	Livello di tensione superato (Limite inferiore)		E65	Livello di tensione superato (Limite superiore)	
E66	Livello di flusso gas superato (Limite inferiore)		E67	Livello di flusso gas superato (Limite superiore)	
E71	Sovratemperatura liquido refrigerante		E74	Livello di corrente motore 1 superato	
E76	Livello di flusso liquido refrigerante superato		E77	Livello di temperatura liquido refrigerante	
E80	Mancanza filo (wire end)		E81	Sovracorrente (pompa WU)	
E82	Errore di comunicazione (WU)		E83	Pompa bloccata	
E99.2	Allarme configurazione impianto (inverter)		E99.3	Allarme configurazione impianto (FP)	
E99.4	Allarme configurazione impianto (FP)		E99.5	Allarme configurazione impianto (FP)	
E99.6	Allarme configurazione impianto		E99.11	Memoria guasta	

9. DIAGNOSTICA E SOLUZIONI

Avanzamento filo bloccato

Causa

- » Pulsante torcia difettoso.
- » Rulli non corretti o consumati
- » Motoriduttore difettoso.

Soluzione

- » Sostituire il componente danneggiato.
- » Rivolgersi al più vicino centro di assistenza per la riparazione dell'impianto.
- » Sostituire i rulli.
- » Sostituire il componente danneggiato.
- » Rivolgersi al più vicino centro di assistenza per la riparazione dell'impianto.

» Guaina torcia danneggiata.

» Sostituire il componente danneggiato.

» Rivolgersi al più vicino centro di assistenza per la riparazione dell'impianto.

» Trainafilo non alimentato

» Verificare la connessione al generatore.

» Consultare il capitolo "Allacciamento".

» Rivolgersi al più vicino centro di assistenza per la riparazione dell'impianto.

» Avvolgimento irregolare su bobina.

» Ripristinare le normali condizioni di svolgimento della bobina o sostituirla.

» Ugello torcia fuso (filo incollato)

» Sostituire il componente danneggiato.

Avanzamento filo non regolare

Causa

» Pulsante torcia difettoso.

Soluzione

» Sostituire il componente danneggiato.

» Rivolgersi al più vicino centro di assistenza per la riparazione dell'impianto.

» Rulli non corretti o consumati

» Sostituire i rulli.

» Motoriduttore difettoso.

» Sostituire il componente danneggiato.

» Rivolgersi al più vicino centro di assistenza per la riparazione dell'impianto.

» Guaina torcia danneggiata.

» Sostituire il componente danneggiato.

» Rivolgersi al più vicino centro di assistenza per la riparazione dell'impianto.

» Frizione aspo o dispositivi di bloccaggio rulli regolati male.

» Allentare la frizione.

» Aumentare la pressione sui rulli.

Inclusioni di scoria

Causa

» Incompleta asportazione della scoria.

Soluzione

» Eseguire una accurata pulizia dei pezzi prima di eseguire la saldatura.

» Elettrodo di diametro troppo grosso.

» Utilizzare un elettrodo di diametro inferiore.

» Preparazione dei lembi non corretta.

» Aumentare l'apertura del cianfrino.

» Modalità di esecuzione della saldatura non corretta.

» Ridurre la distanza tra elettrodo e pezzo.

» Avanzare regolarmente durante tutte le fasi della saldatura.

Soffiature

Causa

» Protezione di gas insufficiente.

Soluzione

» Regolare il corretto flusso di gas.

» Verificare che diffusore e l'ugello gas della torcia siano in buone condizioni.

Incollature

Causa

» Lunghezza d'arco non corretta.

Soluzione

» Aumentare la distanza tra elettrodo e pezzo.

» Aumentare la tensione di saldatura.

» Parametri di saldatura non corretti.

» Aumentare la corrente di saldatura.

» Aumentare la tensione di saldatura.

» Modalità di esecuzione della saldatura non corretta.

» Angolare maggiormente l'inclinazione della torcia.

» Pezzi da saldare di consistenti dimensioni.

» Aumentare la corrente di saldatura.

» Aumentare la tensione di saldatura.

» Dinamica d'arco non corretta.

» Aumentare il valore induttivo del circuito.

Incisioni marginali

Causa

- » Parametri di saldatura non corretti.
- » Lunghezza d'arco non corretta.
- » Modalità di esecuzione della saldatura non corretta.
- » Protezione di gas insufficiente.

Soluzione

- » Ridurre la corrente di saldatura.
- » Ridurre la distanza tra elettrodo e pezzo.
- » Ridurre la tensione di saldatura.
- » Ridurre la velocità di oscillazione laterale nel riempimento.
- » Ridurre la velocità di avanzamento in saldatura.
- » Utilizzare gas adatti ai materiali da saldare.

Ossidazioni

Causa

- » Protezione di gas insufficiente.

Soluzione

- » Regolare il corretto flusso di gas.
- » Verificare che diffusore e l'ugello gas della torcia siano in buone condizioni.

Porosità

Causa

- » Presenza di grasso, vernice, ruggine o sporcizia sui pezzi da saldare.
- » Presenza di grasso, vernice, ruggine o sporcizia sul materiale d'apporto.
- » Presenza di umidità nel materiale d'apporto.
- » Lunghezza d'arco non corretta.
- » Presenza di umidità nel gas di saldatura.
- » Protezione di gas insufficiente.
- » Solidificazione del bagno di saldatura troppo rapida.

Soluzione

- » Eseguire una accurata pulizia dei pezzi prima di eseguire la saldatura.
- » Utilizzare sempre prodotti e materiali di qualità.
- » Mantenere sempre in perfette condizioni il materiale d'apporto.
- » Utilizzare sempre prodotti e materiali di qualità.
- » Mantenere sempre in perfette condizioni il materiale d'apporto.
- » Ridurre la distanza tra elettrodo e pezzo.
- » Ridurre la tensione di saldatura.
- » Utilizzare sempre prodotti e materiali di qualità.
- » Provvedere al mantenimento in perfette condizioni dell'impianto di alimentazione del gas.
- » Regolare il corretto flusso di gas.
- » Verificare che diffusore e l'ugello gas della torcia siano in buone condizioni.
- » Ridurre la velocità di avanzamento in saldatura.
- » Eseguire un preriscaldamento dei pezzi da saldare.
- » Aumentare la corrente di saldatura.

Cricche a caldo

Causa

- » Parametri di saldatura non corretti.
- » Presenza di grasso, vernice, ruggine o sporcizia sui pezzi da saldare.
- » Presenza di grasso, vernice, ruggine o sporcizia sul materiale d'apporto.
- » Modalità di esecuzione della saldatura non corretta.
- » Pezzi da saldare con caratteristiche dissimili.

Soluzione

- » Ridurre la corrente di saldatura.
- » Eseguire una accurata pulizia dei pezzi prima di eseguire la saldatura.
- » Utilizzare sempre prodotti e materiali di qualità.
- » Mantenere sempre in perfette condizioni il materiale d'apporto.
- » Eseguire le corrette sequenze operative per il tipo di giunto da saldare.
- » Eseguire una imburatura prima di realizzare la saldatura.

Cricche a freddo

Causa

- » Presenza di umidità nel materiale d'apporto.
- » Geometria particolare del giunto da saldare.

Soluzione

- » Utilizzare sempre prodotti e materiali di qualità.
- » Mantenere sempre in perfette condizioni il materiale d'apporto.
- » Eseguire un preriscaldamento dei pezzi da saldare.
- » Eseguire un postriscaldamento.
- » Eseguire le corrette sequenze operative per il tipo di giunto da saldare.

10. ISTRUZIONI OPERATIVE

IT

10.1 Saldatura a filo continuo (MIG/MAG)

Introduzione

Un sistema MIG è formato da un generatore in corrente continua, un alimentatore e una bobina di filo, una torcia e gas.

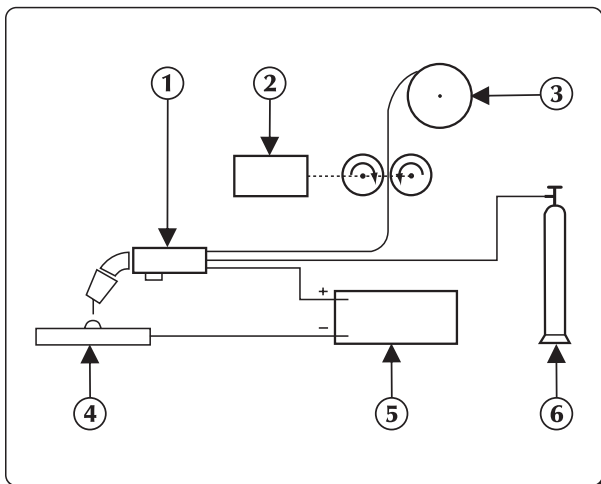

Impianto di saldatura manuale

La corrente viene trasferita all'arco attraverso l'elettrodo fusibile (filo posto a polarità positiva);

In questo procedimento il metallo fuso è trasferito sul pezzo da saldare attraverso l'arco.

L'alimentazione del filo è resa necessaria per reintegrare il filo d'apporto fuso durante la saldatura.

1. Torcia
2. Trainafilo
3. Filo di saldatura
4. Pezzo da saldare
5. Generatore
6. Bombola

Metodi di procedimento

Nella saldatura sotto protezione di gas, le modalità secondo cui le gocce si staccano dall'elettrodo definiscono due sistemi di trasferimento.

Un primo metodo definito "TRASFERIMENTO A CORTO CIRCUITO (SHORT-ARC)", fa entrare l'elettrodo a contatto diretto con il bagno, si fa quindi un cortocircuito con effetto fusibile da parte del filo che si interrompe, dopo di che l'arco si riaccende ed il ciclo si ripete.

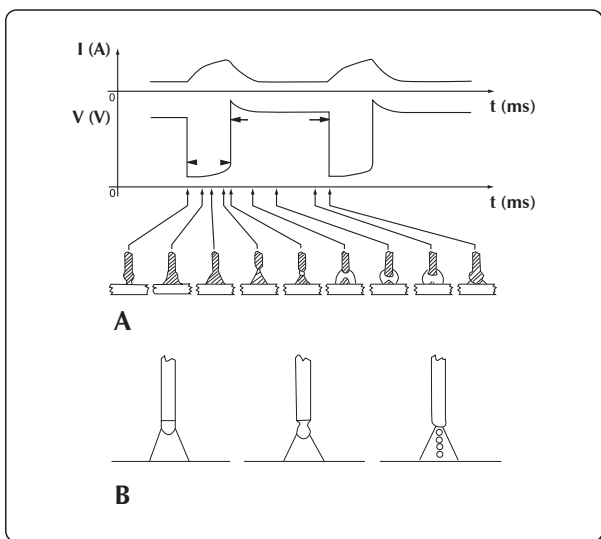

Ciclo SHORT e saldatura SPRAY ARC

Un altro metodo per ottenere il trasferimento delle gocce è il cosiddetto "TRASFERIMENTO A SPRUZZO (SPRAY-ARC)", che consente alle gocce di staccarsi dall'elettrodo e in un secondo tempo giungono nel bagno di fusione.

Parametri di saldatura

La visibilità dell'arco riduce la necessità di una rigida osservanza delle tabelle di regolazione da parte dell'operatore che ha la possibilità di controllare direttamente il bagno di fusione.

- La tensione influenza direttamente l'aspetto del cordone, ma le dimensioni della superficie saldata possono essere variate a seconda delle esigenze, agendo manualmente sul movimento della torcia in modo da ottenere depositi variabili con tensione costante.
- La velocità di avanzamento del filo è in relazione con la corrente di saldatura.

Nelle due figure seguenti vengono mostrate le relazioni che sussistono tra i vari parametri di saldatura.



Tabella orientativa di guida per la scelta dei parametri di saldatura riferita alle applicazioni più tipiche e ai fili di più comune impiego

Tensione d'arco	Ø 0,8 mm	Ø 1,0-1,2 mm	Ø 1,6 mm	Ø 2,4 mm
16V - 22V SHORT - ARC	 60 - 160 A Bassa penetrazione per piccoli spessori	 100 - 175 A Buon controllo della penetrazione e della fusione	 120 - 180 A Buona fusione in piano e in verticale	 150 - 200 A Non impiegato
24V - 28V SEMI SHORT-ARC (Zona di transizione)	 150 - 250 A Saldatura automatica d'angolo	 200 - 300 A Saldatura automatica a tensione alta	 250 - 350 A Saldatura automatica discendente	 300 - 400 A Non impiegato
30V - 45V SPRAY - ARC	 150 - 250 A Bassa penetrazione, regolazione a 200 A	 200 - 350 A Saldatura automatica a passate multiple	 300 - 500 A Buona penetrazione in discendente	 500 - 750 A Buona penetrazione alto deposito su grossi spessori

Unalloyed steel

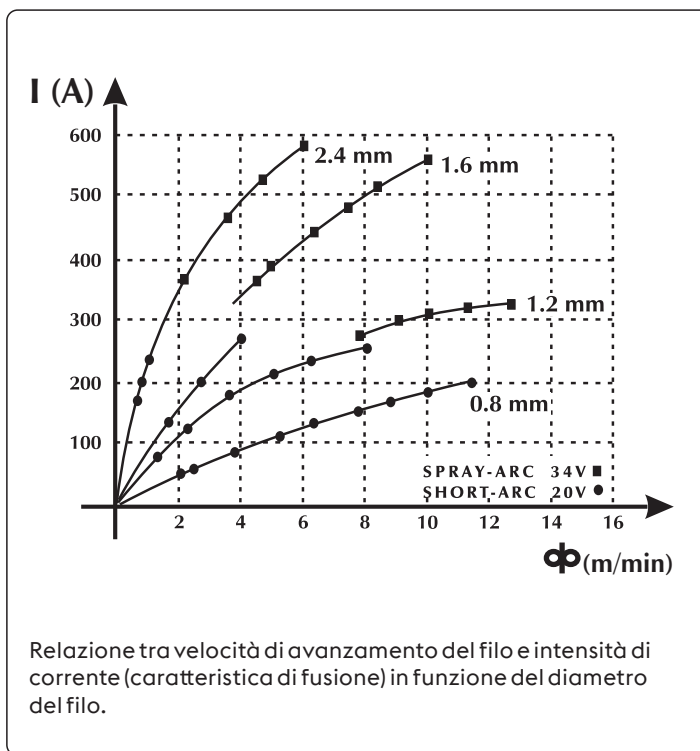
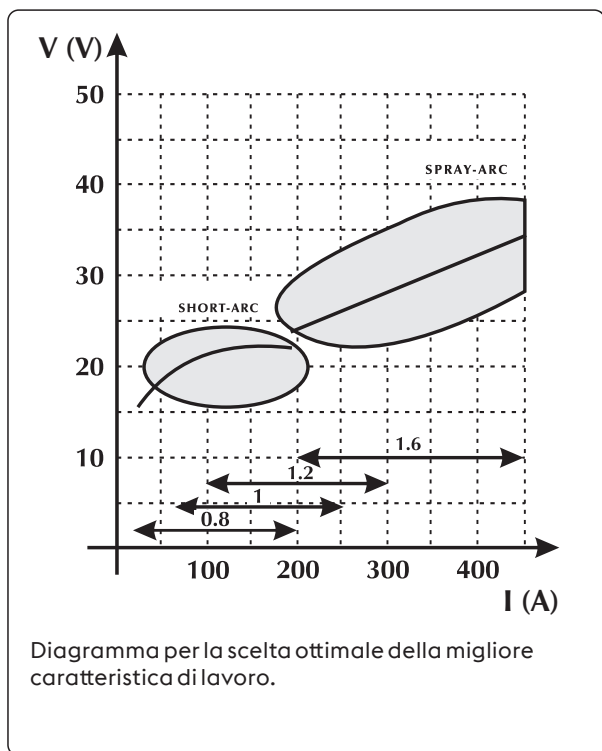
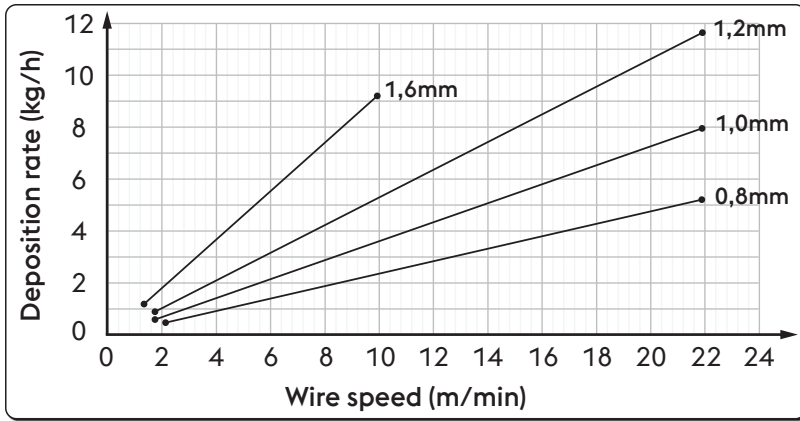

Ø	Wire speed	Deposition rate
0,8 mm	2,0 m/min	0,5 kg/h
	22,0 m/min	5,3 kg/h
1,0 mm	1,6 m/min	0,6 kg/h
	22,0 m/min	8,1 kg/h
1,2 mm	1,6 m/min	0,9 kg/h
	22,0 m/min	11,7 kg/h
1,6 mm	1,2 m/min	1,1 kg/h
	10,0 m/min	9,4 kg/h

High alloyed steel

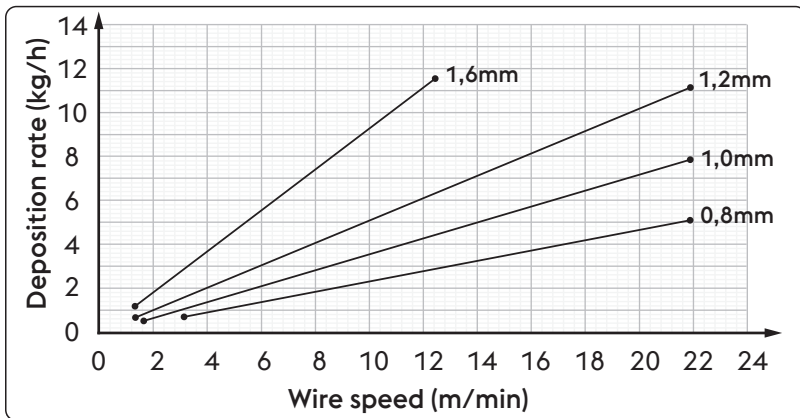

Ø	Wire speed	Deposition rate
0,8 mm	2,0 m/min	0,5 kg/h
	22,0 m/min	5,3 kg/h
1,0 mm	1,6 m/min	0,6 kg/h
	22,0 m/min	8,1 kg/h
1,2 mm	1,6 m/min	0,9 kg/h
	22,0 m/min	11,7 kg/h
1,6 mm	1,2 m/min	1,1 kg/h
	10,0 m/min	9,4 kg/h

Aluminum alloy

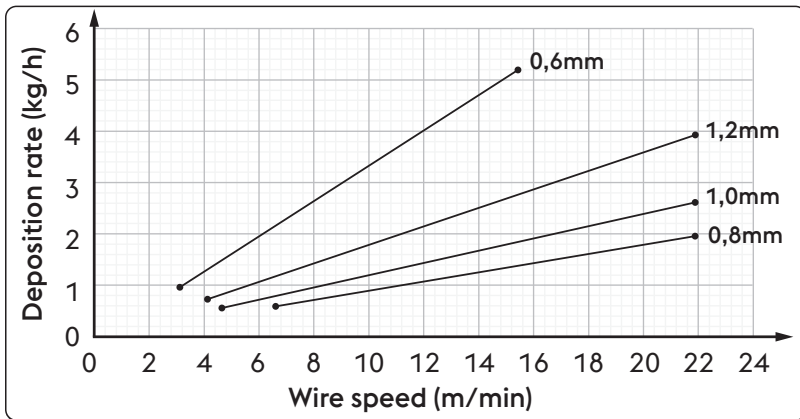

Ø	Wire speed	Deposition rate
0,8 mm	6,5 m/min	0,6 kg/h
	22,0 m/min	2,0 kg/h
1,0 mm	4,5 m/min	0,5 kg/h
	22,0 m/min	2,6 kg/h
1,2 mm	4,0 m/min	0,7 kg/h
	22,0 m/min	4,0 kg/h
1,6 mm	3,0 m/min	0,9 kg/h
	15,5 m/min	5,2 kg/h

Gas utilizzabili

La saldatura MIG-MAG è caratterizzata principalmente dal tipo di gas utilizzato, inerte per la saldatura MIG (Metal Inert Gas), attivo nella saldatura MAG (Metal Active Gas).

- Anidride carbonica (CO₂)

Utilizzando CO₂ come gas di protezione si ottengono elevate penetrazioni con elevata velocità di avanzamento e buone proprietà meccaniche unitamente ad un basso costo di esercizio. Ciò nonostante l'uso di questo gas crea notevoli problemi sulla composizione chimica finale dei giunti in quanto vi è una perdita di elementi facilmente ossidabili e, contemporaneamente si ha un arricchimento di carbonio del bagno.

La saldatura con CO₂ pura dà anche altri tipi di problemi come l'eccessiva presenza di spruzzi e la formazione di porosità da ossido di carbonio.

- Argon

Questo gas inerte viene usato puro nella saldatura delle leghe leggere mentre per la saldatura di acciai inossidabili al cromo-nichel si preferisce lavorare con l'aggiunta di ossigeno e CO₂ in percentuale 2%, questo contribuisce alla stabilità dell'arco e alla migliore forma del cordone.

- Elio

Questo gas si utilizza in alternativa all'argon e consente maggiori penetrazioni (su grandi spessori) e maggiori velocità di avanzamento.

- Miscela Argon-Elio

Si ottiene un arco più stabile rispetto all'elio puro, una maggiore penetrazione e velocità rispetto all'argon.

- Miscela Argon-CO₂ e Argon-CO₂-Ossigeno

Queste miscele vengono impiegate nella saldatura dei materiali ferrosi soprattutto in condizioni di SHORT-ARC in quanto migliora l'apporto termico specifico.

Questo non ne esclude l'uso in SPRAY-ARC.

Normalmente la miscela contiene una percentuale di CO₂ che va dall'8% al 20% e O₂ intorno al 5%.

Consultare il manuale d'uso dell'impianto.

Unalloyed steel / High alloyed steel		Aluminum alloy	
Gamma di corrente	Flusso gas	Gamma di corrente	Flusso gas
3-50 A	10-12 l/min	3-50 A	10-12 l/min
30-100 A	10-14 l/min	30-100 A	10-15 l/min
75-150 A	12-16 l/min	75-150 A	12-18 l/min
150-250 A	14-18 l/min	150-250 A	14-22 l/min
250-400 A	16-20 l/min	250-400 A	16-25 l/min
400-500 A	18-22 l/min	400-500 A	18-30 l/min

11. CARATTERISTICHE TECNICHE

IT

Caratteristiche unità trainafilo WF NX 430 SteelDrive		U.M.
Tipo motoriduttore	SL4R-4T	
Potenza motoriduttore	120	W
Numero rulli	4	
Diametro filo / rullo standard	1.0-1.2	mm
Diametro fili trattabili / rulli trattabili	0.6-1.6 filo pieno 0.8-1.6 filo alluminio 1.2-2.4 filo animato	mm/Materiale
Pulsante spurgo gas	si	
Pulsante avanzamento filo	si	
Pulsante ritiro filo	no	
Velocità avanzamento filo	25 Ø 0.8 - 1.0	m/min
Sinergie	si	
Dispositivi esterni	si (optional)	
Presca per torcia Push-Pull	si (optional)	
Diametro bobina	200/300	mm
Diametro ruote anteriori	63/125 (optional)	mm
Diametro ruote posteriori	63/125 (optional)	mm

Caratteristiche elettriche WF NX 430 SteelDrive		U.M.
Tensione di alimentazione U1	48	Vdc
Tipo di comunicazione	DIGITALE	
Corrente massima assorbita I1max	4.5	A

Fattore di utilizzo WF NX 430 SteelDrive		U.M.
Fattore di utilizzo (40°C)		
(X=50%)	500	A
(X=60%)	470	A
(X=100%)	420	A
Fattore di utilizzo (25°C)		
(X=80%)	500	A
(X=100%)	470	A

Caratteristiche fisiche WF NX 430 SteelDrive		U.M.
Grado di protezione IP	IP23S	
Dimensioni (lxwxh)	640x250x460	mm
Peso	19.0	Kg
Norme di costruzione	EN IEC 60974-5:2019 EN 60974-10/A1:2015	

12. TARGA DATI

VOESTALPINE BÖHLER WELDING SELCO S.R.L. Via Palladio, 19 - ONARA (PADOVA) - ITALY			
WF NX 430		N°	
EN 60974-5:2019 IEC 60974-10/A1:2015 Class A			
	X (40°C)	60%	100%
	I₂	500A	400A
	U₁ 48V	I_{1max} 4.5A	
IP 23 S		UK CA CE EAC	
MADE IN ITALY			

13. SIGNIFICATO TARGA DATI

1		2	
3		4	
5			
	6	6A	6B
	7	7A	7B
8	9	10	
11		UK CA CE EAC	
MADE IN ITALY			

- 1 Marchio di fabbricazione
- 2 Nome ed indirizzo del costruttore
- 3 Modello dell'apparecchiatura
- 4 N° di serie
- X **XXX**XXXXXXXXXX Anno di fabbricazione
- 5 Riferimento alle norme di costruzione
- 6 Simbolo del ciclo di intermittenza
- 7 Simbolo della corrente nominale di saldatura
- 6A Valori del ciclo di intermittenza
- 6B Valori del ciclo di intermittenza
- 7A Valori della corrente nominale di saldatura
- 7B Valori della corrente nominale di saldatura
- 8 Simbolo per l'alimentazione
- 9 Tensione nominale d'alimentazione
- 10 Massima corrente nominale d'alimentazione
- 11 Grado di protezione

- CE Dichiarazione di conformità EU
 EAC Dichiarazione di conformità EAC
 UKCA Dichiarazione di conformità UKCA

EU DECLARATION OF CONFORMITY

The builder
voestalpine Böhler Welding Selco S.r.l. - Via Palladio, 19 - 35019 Onara di Tombolo (PD) - ITALY
Tel. +39 049 9413/111 - Fax +39 049 9413/311 - www.voestalpine.com/welding

EN

declares under its sole responsibility that the following product:

WF NX 430 STEELDRIVE **71.01.083**

conforms to the EU directives:

2014/35/EU **LOW VOLTAGE DIRECTIVE**

2014/30/EU **EMC DIRECTIVE**

2011/65/EU **RoHS DIRECTIVE**

and that following harmonized standards have been duly applied:

EN IEC 60974-5:2019

WIRE FEEDERS

EN 60974-10/A1:2015

ELECTROMAGNETIC COMPATIBILITY REQUIREMENTS

The documentation certifying compliance with the directives will be kept available for inspection at the aforementioned manufacturer.

Any operation or modification that has not been previously authorized by voestalpine Böhler Welding Selco S.r.l. will invalidate this certificate.

Onara di Tombolo, 03/07/2023

voestalpine Böhler Welding Selco s.r.l.

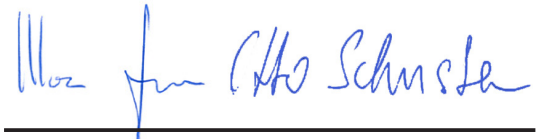

Mirco Frasson

Otto Schuster

Managing Directors

UKCA - DECLARATION OF CONFORMITY

The builder
voestalpine Böhler Welding Selco S.r.l. - Via Palladio, 19 - 35019 Onara di Tombolo (PD) - ITALY
Tel. +39 049 9413/111 - Fax +39 049 9413/311 - www.voestalpine.com/welding

declares under its sole responsibility that the following product:

WF NX 430 STEELDRIVE **71.01.083**

is in conformity with the relevant UK Statutory Instruments (and their amendments):

2016 No. 1091 Electrical Equipment (Safety) Regulations 2016

2016 No. 1101 Electromagnetic Compatibility Regulations 2016

2012 No. 3032 The Restriction of the Use of Certain Hazardous Substances in Electrical and Electronic Equipment Regulations 2012

References to the relevant designated standards used or references to the other technical specifications in relation to which conformity is declared:

EN IEC 60974-5:2019

WIRE FEEDERS

EN 60974-10/A1:2015

ELECTROMAGNETIC COMPATIBILITY REQUIREMENTS

The documentation certifying compliance with the directives will be kept available for inspection at the aforementioned manufacturer.

Any operation or modification that has not been previously authorized by voestalpine Böhler Welding Selco S.r.l. will invalidate this certificate.

Onara di Tombolo, 03/07/2023

voestalpine Böhler Welding Selco s.r.l.

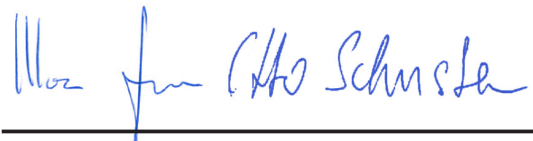

Mirco Frasson

Otto Schuster

Managing Directors

INDEX

1. WARNING	42
1.1 Work environment.....	42
1.2 User's and other persons' protection.....	42
1.3 Protection against fumes and gases.....	43
1.4 Fire/explosion prevention.....	43
1.5 Prevention when using gas cylinders.....	44
1.6 Protection from electrical shock.....	44
1.7 Electromagnetic fields and interferences.....	44
1.8 IP Protection rating.....	45
1.9 Disposal.....	45
2. INSTALLATION	45
2.1 Lifting, transport & unloading.....	45
2.2 Positioning of the equipment.....	46
2.3 Connection.....	46
2.4 Installation.....	46
3. SYSTEM PRESENTATION	48
3.1 Rear panel.....	48
3.2 Sockets panel.....	48
3.3 Front control panel.....	49
4. EQUIPMENT USE	50
4.1 Starting Screen.....	50
4.2 Test screen.....	50
4.3 Main Screen.....	50
5. SETUP	54
5.1 Parameter set up and setting.....	54
5.2 Specific procedures parameters.....	63
6. ACCESSORIES	66
7. MAINTENANCE	67
7.1 Carry out the following periodic checks on the power source.....	67
7.2 Responsibility.....	67
8. ALARM CODES	67
9. TROUBLESHOOTING	69
10. OPERATING INSTRUCTIONS	71
10.1 Continuous wire welding (MIG/MAG).....	71
11. TECHNICAL SPECIFICATIONS	76
12. RATING PLATE	77
13. MEANING RATING PLATE	77
14. DIAGRAM	459
15. CONNECTORS	460
16. SPARE PARTS LIST	461
17. INSTALLATION KIT/ACCESSORIES	464

SYMBOLS



Imminent danger of serious body harm and dangerous behaviours that may lead to serious body harm.



Important advice to be followed in order to avoid minor injuries or damage to property.



Technical notes to facilitate operations.

1. WARNING



Before performing any operation on the machine, make sure that you have thoroughly read and understood the contents of this booklet. Do not perform modifications or maintenance operations which are not prescribed. Do not consult qualified personnel for any doubt or problem concerning the use of the machine, even if not described herein. Do not perform modifications or maintenance operations which are not prescribed. The manufacturer cannot be held responsible for damages to persons or property caused by misuse or non-application of the contents of this booklet by the user.

The operating instructions must always be at hand wherever the device is being used. In addition to the operating instructions, attention must also be paid to any generally applicable and local regulations regarding accident prevention and environmental protection.



All persons involved in commissioning, operating, maintaining and servicing the device must:

- be suitably qualified
- have sufficient knowledge of welding
- read and follow these operating instructions carefully

Please consult qualified personnel if you have any doubts or difficulties in using the equipment.

1.1 Work environment



All equipment shall be used exclusively for the operations for which it was designed, in the ways and ranges stated on the rating plate and/or in this booklet, according to the national and international directives regarding safety. Other uses than the one expressly declared by the manufacturer shall be considered totally inappropriate and dangerous and in this case the manufacturer disclaims all responsibility.



This unit must be used for professional applications only, in industrial environments. The manufacturer will accept no responsibility for any damages caused by use in domestic environments.



The equipment must be used in environments with a temperature between -10°C and +40°C (between +14°F and +104°F).

The equipment must be transported and stored in environments with a temperature between -25°C and +55°C (between -13°F and 131°F).

The equipment must be used in environments free from dust, acid, gas or any other corrosive substances.

The equipment shall not be used in environments with a relative humidity higher than 50% at 40°C (104°F).

The equipment shall not be used in environments with a relative humidity higher than 90% at 20°C (68°F).

The system must not be used at an higher altitude than 2,000 metres (6,500 feet) above sea level.



Do not use this machine to defrost pipes.

Do not use this equipment to charge batteries and/or accumulators.

Do not use this equipment to jump-start engines.

1.2 User's and other persons' protection



The welding process is a noxious source of radiation, noise, heat and gas emissions. Position a fire-retardant shield to protect the surrounding welding area from rays, sparks and incandescent slags. Advise any person in the area of welding not to stare at the arc or at the incandescent metal and to get an adequate protection.



Wear protective clothing to protect your skin from the arc rays, sparks or incandescent metal. Clothes must cover the whole body and must be:

- intact and in good conditions
- fireproof
- insulating and dry
- well-fitting and without cuffs or turn-ups



Always use regulation shoes that are strong and ensure insulation from water.

Always use regulation gloves ensuring electrical and thermal insulation.



Wear masks with side face guards and a suitable protection filter (at least NR10 or above) for the eyes.



Always wear safety goggles with side guards, especially during the manual or mechanical removal of welding slag.



Do not wear contact lenses!



Use headphones if dangerous noise levels are reached during the welding. If the noise level exceeds the limits prescribed by law, delimit the work area and make sure that anyone getting near it is protected with headphones or earphones.



Always keep the side covers closed while welding. The system must not be modified in any way. Avoid your hands, hair, clothes, tools ... coming into contact with moving parts such as: fans, gears, rollers and shafts, wire reels. Do not touch gears while the wire feed unit is working. Bypassing the protection devices fitted on wire feed units is extremely dangerous and releases the manufacturer from any responsibility in respect of damages to either people or property.



While loading and feeding the wire, keep your head away from the MIG/MAG torch. The wire that is coming out can seriously damage your hands, face and eyes.



Avoid touching items that have just been welded: the heat could cause serious burning or scorching. Follow all the precautions described above also in all operations carried out after welding since slag may detach from the items while they are cooling off.



Check that the torch is cold before working on or maintaining it.



Ensure the cooling unit is switched off before disconnecting the pipes of the cooling liquid. The hot liquid coming out of the pipes might cause burning or scorching.



Keep a first aid kit ready for use. Do not underestimate any burning or injury.



Before leaving work, make the area safe, in order to avoid accidental damage to people or property.

1.3 Protection against fumes and gases



Fumes, gases and powders produced during the welding process can be noxious for your health. Under certain circumstances, the fumes caused by welding can cause cancer or harm the foetus of pregnant women.

- Keep your head away from any welding gas and fumes.
- Provide proper ventilation, either natural or forced, in the work area.
- In case of poor ventilation, use masks and breathing apparatus.
- In case of welding in extremely small places the work should be supervised by a colleague standing nearby outside.
- Do not use oxygen for ventilation.
- Ensure that the fumes extractor is working by regularly checking the quantity of harmful exhaust gases versus the values stated in the safety regulations.
- The quantity and the danger level of the fumes depends on the parent metal used, the filler material and on any substances used to clean and degrease the pieces to be welded. Follow the manufacturer's instructions together with the instructions given in the technical data sheets.
- Do not perform welding operations near degreasing or painting stations.
- Position gas cylinders outdoors or in places with good ventilation.

1.4 Fire/explosion prevention



The welding process may cause fires and/or explosions.

- Clear the work area and the surrounding area from any flammable or combustible materials or objects.
- Flammable materials must be at least 11 metres (35 feet) from the welding area or they must be suitably protected.
- Sparks and incandescent particles might easily be sprayed quite far and reach the surrounding areas even through minute openings. Pay particular attention to keep people and property safe.
- Do not perform welding operations on or near containers under pressure.
- Do not perform welding or cutting operations on closed containers or pipes. Pay particular attention during welding operations on pipes or containers even if these are open, empty and have been cleaned thoroughly. Any residue of gas, fuel, oil or similar materials might cause an explosion.
- Do not weld in places where explosive powders, gases or vapours are present.
- When you finish welding, check that the live circuit cannot accidentally come in contact with any parts connected to the earth circuit.
- Position a fire-fighting device or material near the work area.

1.5 Prevention when using gas cylinders



Inert gas cylinders contain pressurized gas and can explode if the minimum safe conditions for transport, storage and use are not ensured.

- Cylinders must be secured in a vertical position to a wall or other supporting structure, with suitable means so that they cannot fall or accidentally hit anything else.
- Screw the cap on to protect the valve during transport, commissioning and at the end of any welding operation.
- Do not expose cylinders to direct sunlight, sudden changes of temperature, too high or extreme temperatures. Do not expose cylinders to temperatures too low or too high.
- Keep cylinders away from naked flames, electric arcs, torches or electrode guns and incandescent material sprayed by welding.
- Keep cylinders away from welding circuits and electrical circuits in general.
- Keep your head away from the gas outlet when opening the cylinder valve.
- Always close the cylinder valve at the end of the welding operations.
- Never perform welding operations on a pressurized gas cylinder.
- A compressed air cylinder must never be directly coupled to the machine pressure reducer! Pressure might exceed the capacity of the reducer which could consequently explode!

1.6 Protection from electrical shock



Electric shocks can kill you.

- Avoid touching live parts both inside and outside the welding system while this is active (torches, guns, earth cables, electrodes, wires, rollers and spools are electrically connected to the welding circuit).
- Make sure that the welding system and the welder are electrically isolated by using dry bases and floors that are adequately isolated from earth.
- Ensure the system is connected correctly to a socket and a power source equipped with an earth conductor.
- Do not touch two torches or two electrode holders at the same time.
- If you feel an electric shock, interrupt the welding operations immediately.

1.7 Electromagnetic fields and interferences



The current passing through the internal and external system cables creates an electromagnetic field in the proximity of the welding cables and the equipment itself.

- Electromagnetic fields can affect the health of people who are exposed to them for a long time (the exact effects are still unknown).
- Electromagnetic fields can interfere with some equipment like pacemakers or hearing aids.



Persons fitted with pacemakers must consult their doctor before undertaking arc welding operations.

1.7.1 EMC classification in accordance with: EN 60974-10/A1:2015.



Class B equipment complies with electromagnetic compatibility requirements in industrial and residential environments, including residential locations where the electrical power is provided by the public low-voltage supply system.



Class A equipment is not intended for use in residential locations where the electrical power is provided by the public low-voltage supply system. There may be potential difficulties in ensuring electromagnetic compatibility of class A equipment in those locations, due to conducted as well as radiated disturbances.

For more informations, check the chapter: RATING PLATE or TECHNICAL SPECIFICATIONS.

1.7.2 Installation, use and area examination

This equipment is manufactured in compliance with the requirements of the harmonized standard EN 60974-10/A1:2015 and is identified as "CLASS A" equipment. This unit must be used for professional applications only, in industrial environments. The manufacturer will accept no responsibility for any damages caused by use in domestic environments.



The user must be an expert in the activity and as such is responsible for installation and use of the equipment according to the manufacturer's instructions. If any electromagnetic interference is noticed, the user must solve the problem, if necessary with the manufacturer's technical assistance.



In any case electromagnetic interference problems must be reduced until they are not a nuisance any longer.



Before installing this equipment, the user must evaluate what electromagnetic problems it might cause in the surrounding area, with specific regard to the health of persons nearby, pace-maker and hearing aid users, for example.

1.7.3 Precautions regarding cables

To minimise the effects of electromagnetic fields follow the following instructions:

- Where possible, collect and secure the earth and power cables together.
- Never coil the cables around your body.
- Do not place your body in between the earth and power cables (keep both on the same side).
- The cables must be kept as short as possible, positioned as close as possible to each other and laid at or approximately at ground level.
- Position the equipment at some distance from the welding area.
- The cables must be kept away from any other cables.

1.7.4 Earthing connection

The earth connection of all the metal components in the welding (cutting) equipment and in the close area must be taken in consideration. The earthing connection must be made according to the local regulations.

1.7.5 Earthing the workpiece

When the workpiece is not earthed for electrical safety reasons or due to its size and position, the earthing of the workpiece may reduce the emissions. It is important to remember that the earthing of the workpiece should neither increase the risk of accidents for the user nor damage other electric equipment. The earthing must be made according to the local regulations.

1.7.6 Shielding

The selective shielding of other cables and equipment present in the surrounding area may reduce the problems due to electromagnetic interference.

The shielding of the entire welding equipment can be taken in considered for special applications.

1.8 IP Protection rating



IP23S

- Enclosure protected against access to dangerous parts by fingers and against ingress of solid bodies objects with diameter equal or greater than 12.5 mm.
- Enclosure protected against rain at an angle of 60°.
- Enclosure protected against harmful effects due to the ingress of water when the moving parts of the equipment are not operating.

1.9 Disposal



Do not dispose of electrical equipment together with normal waste!

In conformity to European Directive 2012/19/EU on Waste Electrical and Electronic Equipment and its implementation according to national law, electrical equipment must be collected separately and disposed of through an authorised recovery and disposal centre at the end of its life cycle. The owner of the equipment is required to identify authorised collection centres on the basis of the information provided by Local Authorities. By applying this European Directive you will improve the environment and human health!

» For further information, refer to the website.

2. INSTALLATION



Installation should be performed only by expert personnel authorised by the manufacturer.



During installation, ensure that the power source is disconnected from the mains.

2.1 Lifting, transport & unloading

- The equipment is provided with a handle for hand transportation.
- The equipment is not equipped with specific lifting elements.
- Use a fork lift truck paying attention during operations in order to prevent the generator from tipping over.



Do not underestimate the weight of the equipment: see technical specifications.
Do not move or position the suspended load above persons or things.
Do not drop or apply undue pressure on the equipment.

2.2 Positioning of the equipment



Keep to the following rules:

- Provide easy access to the equipment controls and connections.
- Do not position the equipment in very small spaces.
- Do not place the equipment on surfaces with inclination exceeding 10° from to the horizontal plane.
- Position the equipment in a dry, clean and suitably ventilated place.
- Protect the equipment against pouring rain and sun.

2.3 Connection





The mobile units are powered exclusively at low voltage.

2.4 Installation

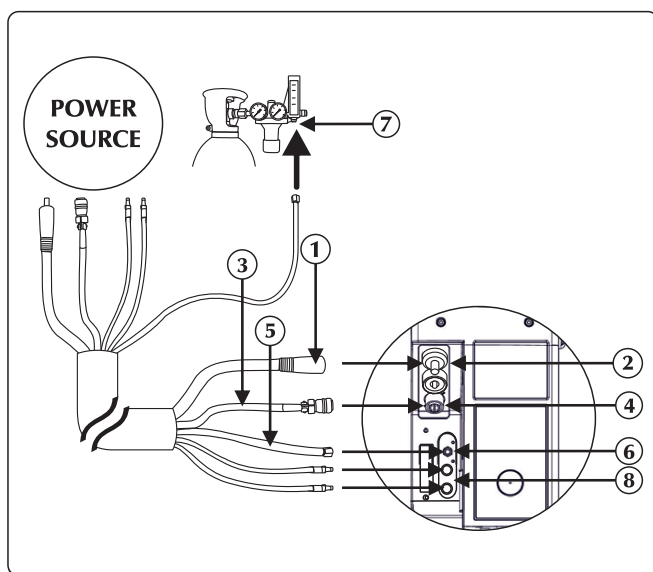
2.4.1 Connection for MIG/MAG welding



- ① Power cable
- ② Positive power socket (+)
- ③ Signal cable
- ④ Signal cable input
- ⑤ Gas tube
- ⑥ Gas union-connection
- ⑦ Gas supply connector
- ⑧ Cooling liquid connection

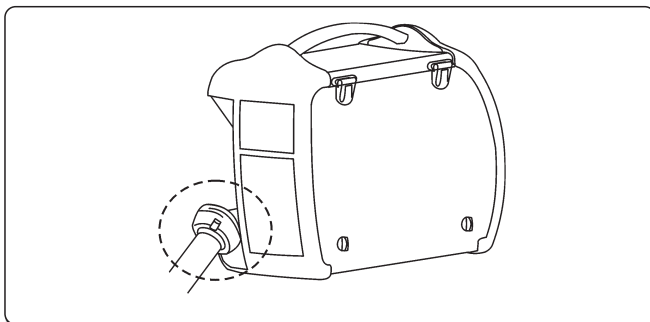

- ▶ Connect the power cable to the appropriate outlet. Insert the plug and turn clockwise until all parts are secured.
- ▶ Connect the signal cable to the appropriate connector. Insert the connector and rotate the ring nut clockwise until the parts are properly secured.
- ▶ Connect the gas hose to the pressure reducing valve of the cylinder or to the gas supply connection. Adjust the gas flow from 10 to 30 l/min.
- ▶ Connect the water pipe (blue coloured) to the outlet quick connector (blue coloured - symbol ) of the cooling unit.
- ▶ Connect the water pipe (red coloured) to the inlet quick connector (red coloured - symbol ) of the cooling unit.
- ▶ Connect the CAN-BUS signal cable for the control of external devices (such as RC, RI...) to the appropriate connector.

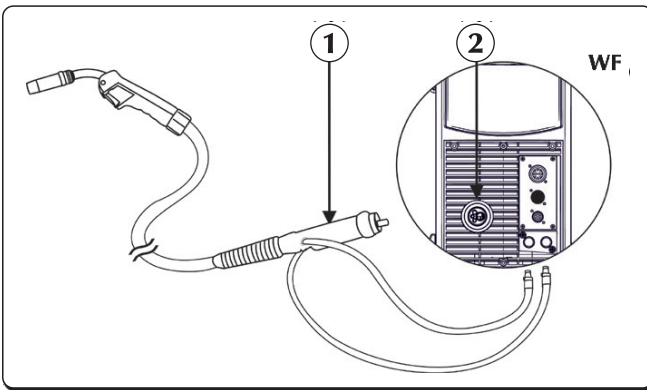

Consult the "Installation accessories" section.



- ① Torch fitting
- ② Connector

- ▶ Connect the water pipe (red coloured) of the torch to the inlet quick connector (red coloured - symbol ) of the cooling unit.
- ▶ Connect the water pipe (blue coloured) of the torch to the outlet quick connector (blue coloured - symbol ) of the cooling unit.
- ▶ Connect the MIG/MAG torch to the central adapter, ensuring that the fastening ring is fully tightened.

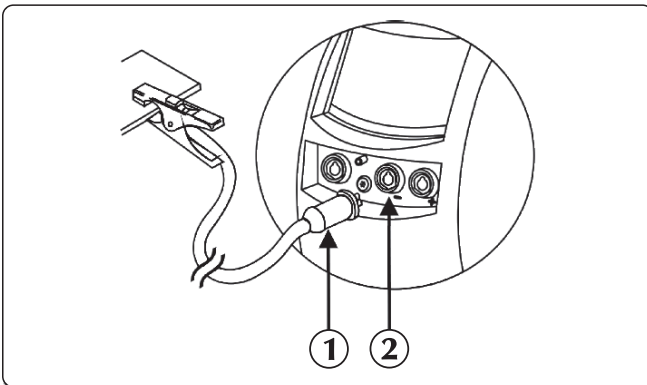

- ① Earth clamp connector
- ② Negative power socket (-)

- ▶ Connect the earth clamp to the negative socket (-) of the power source. Insert the plug and turn clockwise until all parts are secured.

Motor compartment

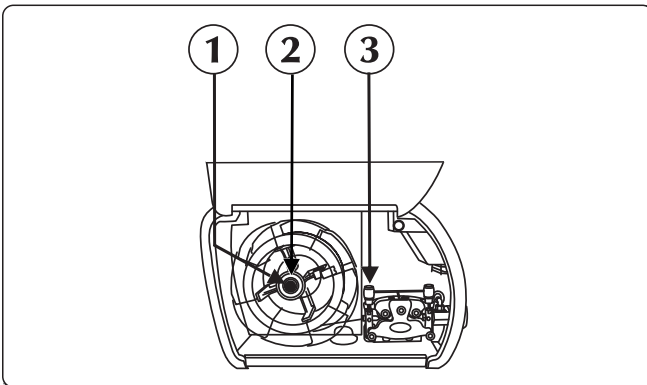

- ① Ring nut
- ② Friction screw
- ③ Rolls lever

- ▶ Open the right side cover.
- ▶ Check that the roller groove is consistent with the diameter of the wire you wish to use.
- ▶ Unscrew the ring nut from the spindle and insert the wire spool.
- ▶ Insert also the spool pin, insert the spool, reposition the ring nut and adjust the friction screw.
- ▶ Release the rolls lever of the wire feeder, sliding the end of the wire into the wire guide bush and, passing it over the roller, into the torch fitting. Lock the feed support in position, checking that the wire has entered the roller groove.
- ▶ To load the wire onto the torch, press the wire feed push-button.
- ▶ Adjust the gas flow from 10 to 30 l/min.

3. SYSTEM PRESENTATION

3.1 Rear panel

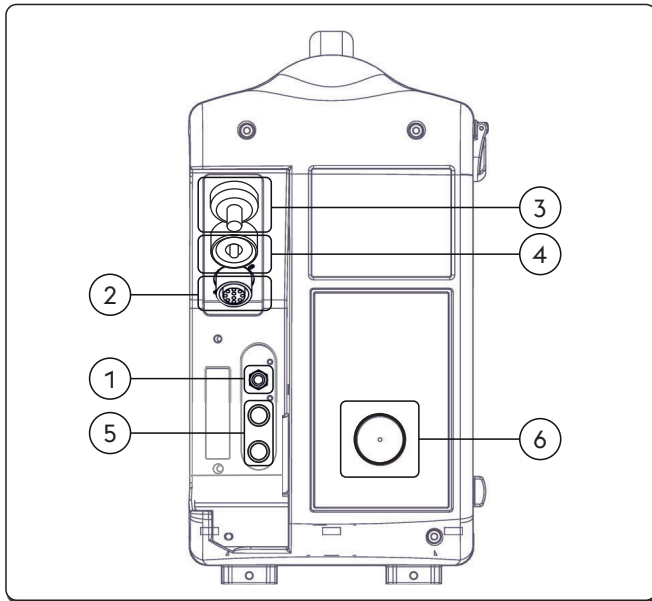

- ① Gas fitting
- ② Signal cable input (CAN bus) (cable bundle)
- ③ Power cable input (cable bundle)
- ④ Positive power socket (+)
- ⑤ Cooling liquid inlet/outlet
- ⑥ Wire input

3.2 Sockets panel

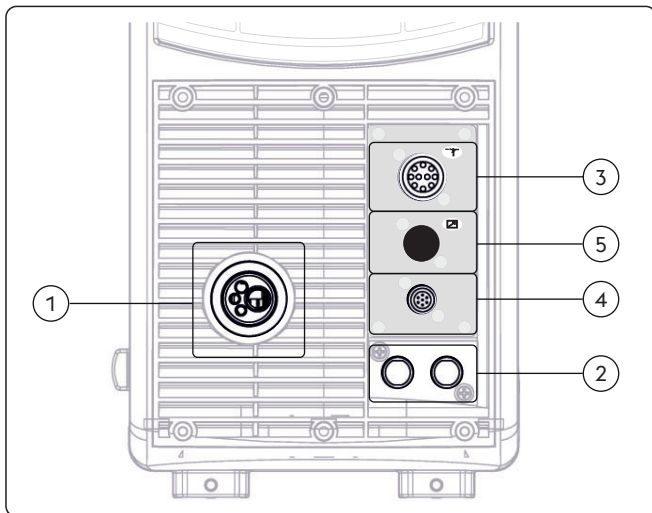





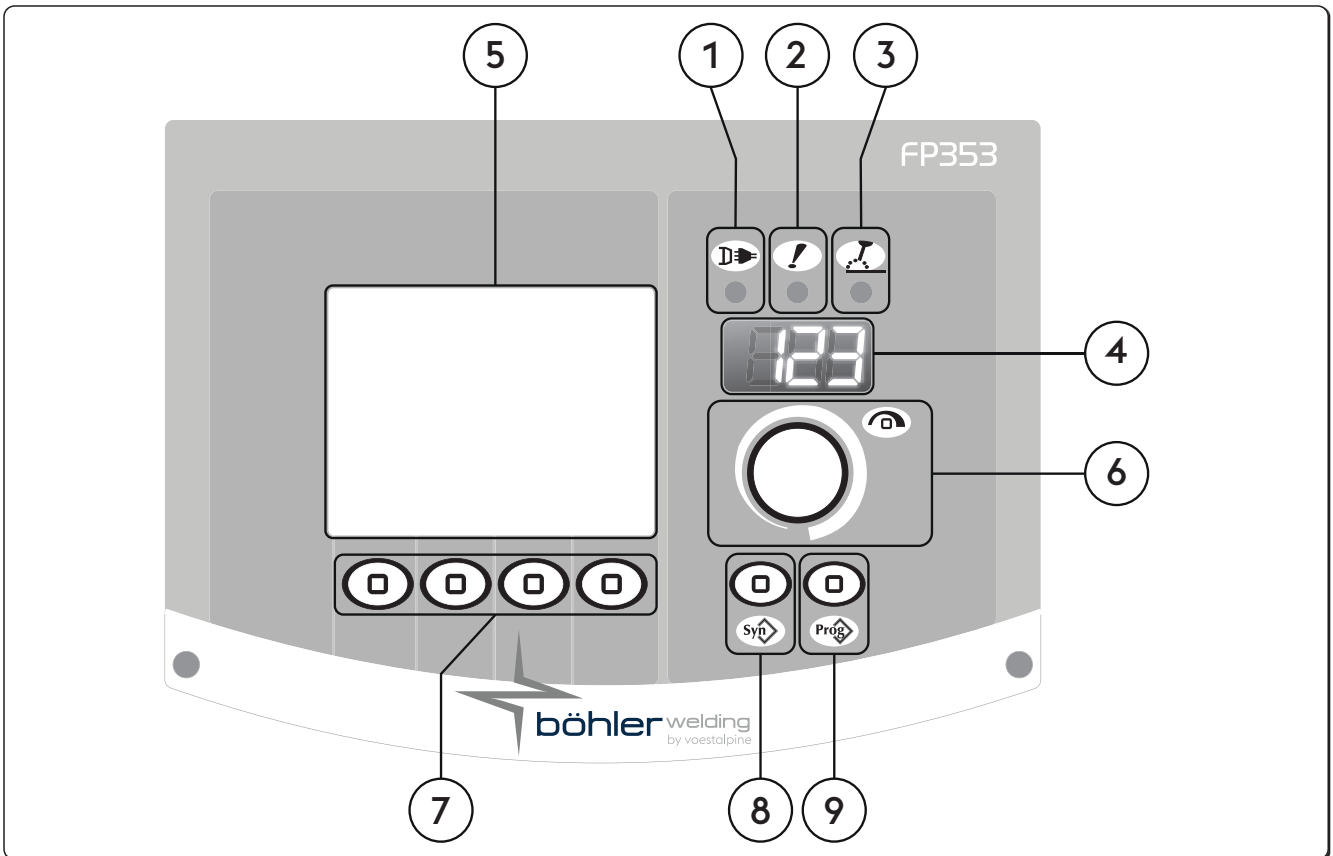

- ① Torch fitting
Permits connection of the MIG/MAG torch.
- ② Cooling liquid connection
- ③ Signal cable input (Push-Pull)
- ④ Signal cable input (torch)
Torch connection
- ⑤ Signal cable input (RC)

EN

3.3 Front control panel



- ①  **Power supply LED**
Indicates that the equipment is connected to the mains and is on.
- ②  **General alarm LED**
Indicates the possible intervention of protection devices such as the temperature protection.
- ③  **Power on LED**
Indicates the presence of voltage on the equipment outlet connections.
- ④  **7-segment display**
Allows the general welding machine parameters to be displayed during start-up, settings, current and voltage readings, while welding, and encoding of the alarms.
- ⑤  **LCD display**
Allows the general welding machine parameters to be displayed during start-up, settings, current and voltage readings, while welding, and encoding of the alarms.
Allows all the operations to be displayed instantaneously.
- ⑥  **Main adjustment handle.**
Allows entry to set up, the selection and the setting of the welding parameters.
- ⑦  **Function keys**
Let you select the various system functions:
- MMA welding process
- Welding methods
- Current pulsation
- Graphic mode

8 Welding programs button

Lets you select a preset welding program by choosing a few simple settings:

- Wire type
- Type of gas
- Wire diameter

9 Job key

EN

4. EQUIPMENT USE

4.1 Starting Screen

When switched on, the generator performs a succession of checks in order to guarantee the correct operation of the system and of all the devices connected to it. At this stage the gas test is also carried out to check the proper connection to the gas supply system.

4.2 Test screen

When the side panel (coil compartment) is open, the welding operations are inhibited. The test screen appears on the LCD display.

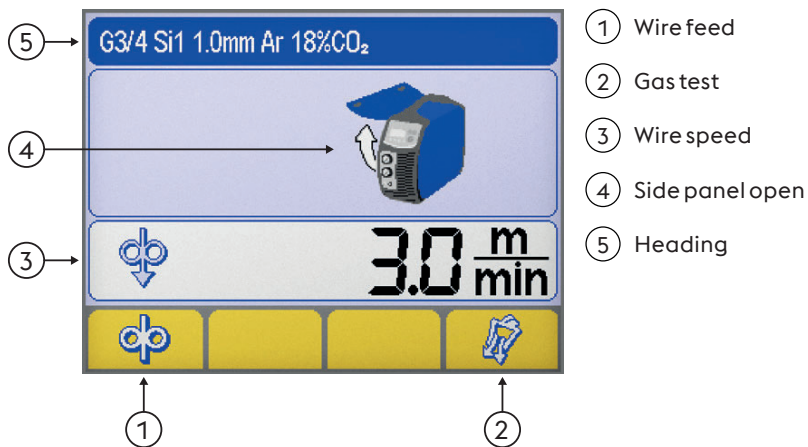

Wire feed

Allows the manual wire feed without gas flow and without the wire live.

Allows the insertion of the wire into the torch sheath during the welding preparation phases.



Gas test

Allows the gas circuit to be cleansed of impurities and the carrying out of the appropriate preliminary gas pressure and flow adjustments, without power on.



Wire speed

It allow wire speed regulation (during wire loading phase).

Minimum	Maximum	Default
0.5 m/min	22.0 m/min	3.0 m/min



Side panel open



Heading

Allows the display of certain pieces of important information relating to the selected process.

4.3 Main Screen

Allows the control of the system and of the welding process, showing the main settings.

4.4 MIG/MAG process main screen

Basic screen

- ① Heading MIG/MAG
- ② Welding parameters
- ③ Functions

Graphic screen

- ① Heading MIG/MAG
- ② Welding parameters
- ③ Functions

Heading MIG/MAG

Allows the display of certain pieces of important information relating to the selected process.

- ① Type of filler metal
- ② Wire diameter
- ③ Type of gas

Synergic curve selected

- ① Type of filler metal
- ② Wire diameter
- ③ Type of gas

- ① Welding current
- ② Workpiece thickness
- ③ Corner bead "a"
- ④ Welding voltage

Welding parameters

- ① Welding current
- ② Workpiece thickness
- ③ Corner bead "a"
- ④ Welding voltage

Welding parameters (Basic screen)

► Select the required parameter by pressing the encoder button.

- ① Welding parameters
- ② Parameter icon
- ③ Parameter value
- ④ Unit of measurement of the parameter

Welding parameters (Graphic screen)

▶ Select the required parameter by pressing the encoder button.

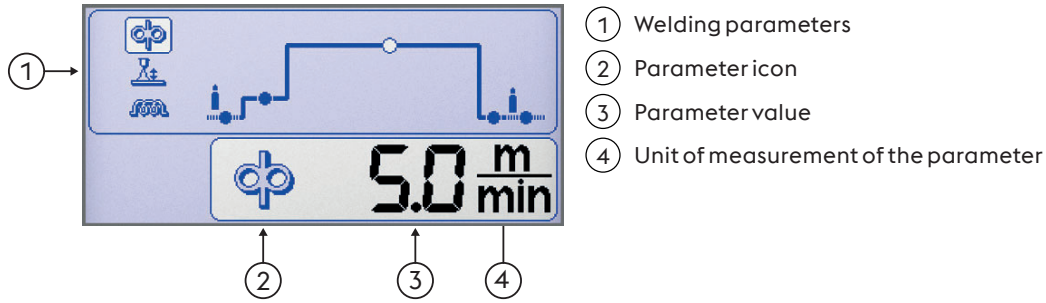

EN

Functions

Allow the setting of the most important process functions and welding methods.

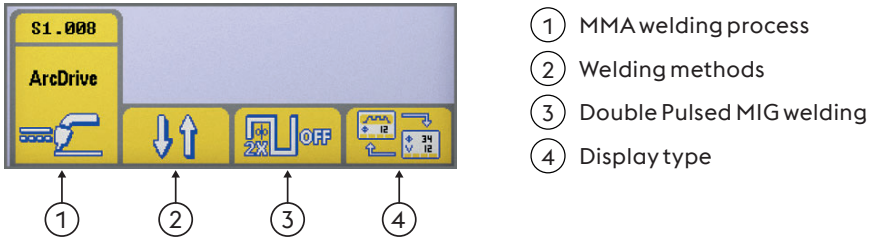

Welding methods

Allows the selection of the welding method

 **2 Step**
In two step, pressing the button causes the gas to flow, feeds voltage to the wire and makes it advance; when it is released, the gas, the voltage and the wire feed are turned off.

 **4 Step**
This button functions in four steps. The first press of the button starts the gas flow, performing a manual pre-gas. Releasing the button powers the wire feed. Pressing the button again stops the wire feed and starts reducing current back to zero. Releasing the button turns off the gas flow.

 **Crater filler**
Allows welding to be done with three different power levels able to be directly selected and controlled by the welder using the torch button.

The first pressure on the button causes the gas to flow, activates the voltage to the wire and feeds it at the speed set by the "initial increment" parameter (during set up) and with the relative synergic values of the welding parameters.

When the torch button is released, the wire speed and the relative synergic parameters change automatically to the main values set on the control panel.

The next pressure on the torch button brings the wire speed and the relative synergic parameters to the pre-set (during set up) crater filler parameter values.

Releasing the torch button stops the wire feed and supplies the power for the burn back and post-gas stages.



Double Pulsed MIG welding

 Double pulsed active

 Double pulsed inactive



Display type

Permits view changes between:

 Basic screen

 Graphic screen

Synergic curves screen



Synergy

Lets you select a preset welding program (synergy) by choosing a few simple settings

Welding process selection

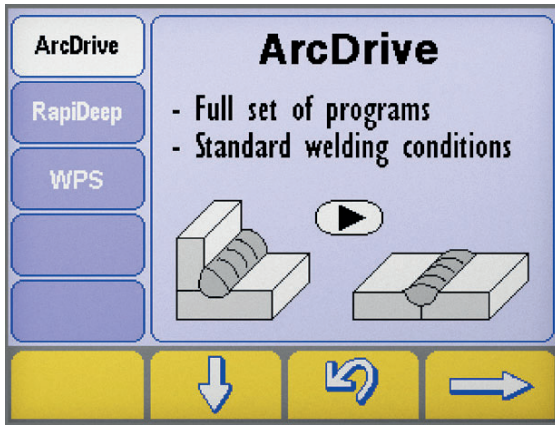

- ▶ Enter the "Synergy" menu by pressing the key for at least a second.
- ▶ Press the relevant keys to select the required process and .
- ▶ Press the button to go to the next step.

EN



Material type/Gas type synergy selection screen

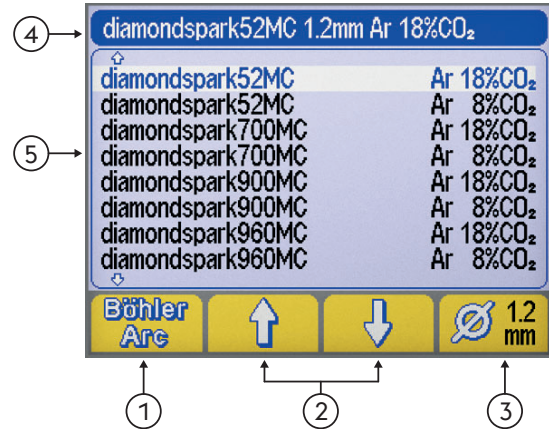

- ① Welding program (BöhlerArc/UniversalArc)
- ② Material/gas selection
- ③ Wire diameter
- ④ Heading
- ⑤ Welding program

Welding program
Allows the selection of the welding program

BöhlerArc UniversalArc

Material/gas selection
Lets you select:

- Type of filler metal
- Type of gas

Wire diameter
Allows selection of the wire diameter used (mm).

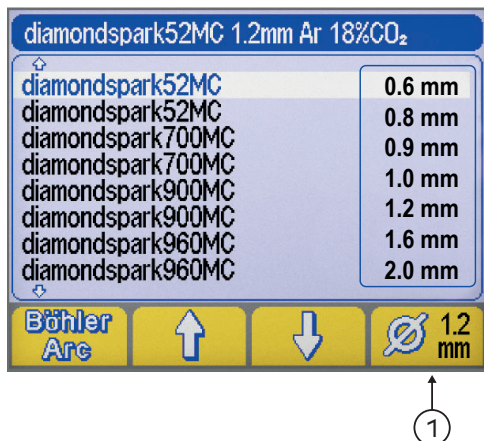

- ① Wire diameter



Heading

Allows the display of certain pieces of important information relating to the selected process.



NO PROGRAM

This indicates that the synergic curve selected is unavailable or is not compatible with the other system settings.

5. SETUP

5.1 Parameter set up and setting

Permits set-up and adjustment of a series of additional parameters for improved and more accurate control of the welding system.

The parameters present at set up are organised in relation to the welding process selected and have a numerical code.

Entry to set up



- ▶ By pressing the encoder button for 5 seconds.
- ▶ The entry will be confirmed by the writing 0 on the display

Selection and adjustment of the required parameter

- ▶ Rotate the encoder until you display the numerical code for the required parameter.
- ▶ If the encoder key is pressed at this point, the value set for the parameter selected can be displayed and adjusted.

Exit from set up

- ▶ To quit the "adjustment" section, press the encoder again.
- ▶ To exit the set-up, go to parameter "0" (save and quit) and press encoder key.
- ▶ Cancel the operation by pressing button
- ▶ To save the change and exit the set up, press the key:

5.1.1 List of set up parameters (MMA)

0 Save and Exit



Allows you to save the changes and exit the set up.

1 Reset



Allows you to reset all the parameters to the default values.

3 Hot start



Allows adjustment of the hot start value in MMA.

Permits an adjustable hot start in the arc striking phases, facilitating the start operations.

Basic electrode

Minimum	Maximum	Default
0/off	500%	80%

Cellulosic electrode

Minimum	Maximum	Default
0/off	500%	150%

CrNi electrode

Minimum	Maximum	Default
0/off	500%	100%

Aluminum electrode

Minimum	Maximum	Default
0/off	500%	120%

Cast Iron electrode

Minimum	Maximum	Default
0/off	500%	100%

7 Welding current



Allows the regulation of the welding current.

Minimum	Maximum	Default
3 A	I _{max}	100 A

8 Arc force



Allows adjustment of the Arc force value in MMA.
Permits an adjustable energetic dynamic response in welding, facilitating the welder's operations.
Increase the value of the Arc force to reduce the risk of electrode sticking.

Basic electrode

Minimum	Maximum	Default
0/off	500%	30%

Cellulosic electrode

Minimum	Maximum	Default
0/off	500%	350%

CrNi electrode

Minimum	Maximum	Default
0/off	500%	30%

Aluminum electrode

Minimum	Maximum	Default
0/off	500%	100%

Cast Iron electrode

Minimum	Maximum	Default
0/off	500%	70%

204 Dynamic power control (DPC)



It enables the desired V/I characteristic to be selected.

I=C Constant current

The increase or reduction in arc length has no effect on the welding current required.

Recommended for electrode: Basic, Rutile, Acid, Steel, Cast irons

1:20 Falling characteristic with adjustable slope

The increase in arc length causes a reduction in welding current (and vice versa) according to the value imposed by 1 to 20 amps per volt.

Recommended for electrode: Cellulosic, Aluminum

P=C Constant power

The increase in arc length causes a reduction in the welding current (and vice versa) according to the law: $V \cdot I = K$

Recommended for electrode: Cellulosic, Aluminum

312 Arc detachment voltage



Allows you to set the voltage value at which the electric arc switch-off is forced.

Allows to manage better the various operating conditions that are created.

In the spot welding phase, for example, a low arc detachment voltage reduces re-striking of the arc when moving the electrode away from the piece, reducing spatter, burning and oxidisation of the piece.

If using electrodes that require high voltages, you are advised to set a high threshold to prevent arc extinction during welding.



Never set an arc detachment voltage higher than the no-load voltage of the power source.

Basic electrode

Minimum	Maximum	Default
0/off	99.9 V	57.0 V

Cellulosic electrode

Minimum	Maximum	Default
0/off	99.9 V	70.0 V

399 Welding speed



Lets you set welding speed.

Default cm/min: reference speed for manual welding.

Syn: Sinergic value.

Minimum	Maximum	Default
1 cm/min	200 cm/min	15 cm/min

500 Machine setting



Allows the selection of the required graphic interface.
Allows access to the higher set-up levels.
Refer to section "Interface personalisation (Set up 500)"

Value	User interface
XE	Easy Mode
XA	Advanced Mode
XP	Professional Mode

Value	Selected level
USER	User
SERV	Service
vaBW	vaBW

551 Lock/unlock



Allows the locking of the panel controls and the insertion of a protection code.
Refer to section "Lock/unlock (Set up 551)".

552 Buzzer tone



Permits adjustment of the buzzer tone.

Minimum	Maximum	Default
0/off	10	10

601 Regulation step



Allows the regulation of a parameter with a step that can be personalised by the operator.

Minimum	Maximum	Default
1	Imax	1

602 External parameter CH1, CH2, CH3, CH4



Allows the management of the external parameter 1, 2, 3, 4 (minimum value, maximum value, default value, parameter selected).
Refer to section "External controls management (Set up 602)".

705 Circuit resistance calibration



Allows the calibration of the system.
Refer to section "Circuit resistance calibration (set up 705)".

751 Current reading



Allow the real value of the welding current to be displayed.

752 Voltage reading



Allows the real value of the welding voltage to be displayed.

768 HI heat input measurement



Allows reading of the value of the measurement of the heat input in welding.

801 Guard limits



Allows the setting of the warning limits and of the guard limits.
Allows the welding process to be controlled by setting warning limits and guard limits for the main measurable parameters.
Allows the accurate control of the various welding phases.
Refer to section "Guard limits (Set up 801)".

5.1.2 List of set up parameters (TIG)

0 Save and Exit



Allows you to save the changes and exit the set up.

1 Reset



Allows you to reset all the parameters to the default values.

7 Welding current



Allows the regulation of the welding current.

Minimum	Maximum	Default
3 A	I _{max}	100 A

399 Welding speed



Lets you set welding speed.

Default cm/min: reference speed for manual welding.

Syn: Sinergic value.

Minimum	Maximum	Default
1 cm/min	200 cm/min	10 cm/min

500 Machine setting



Allows the selection of the required graphic interface.

Allows access to the higher set-up levels.

Refer to section "Interface personalisation (Set up 500)"

Value	User interface
XE	Easy Mode
XA	Advanced Mode
XP	Professional Mode

Value	Selected level
USER	User
SERV	Service
vaBW	vaBW

551 Lock/unlock



Allows the locking of the panel controls and the insertion of a protection code.

Refer to section "Lock/unlock (Set up 551)".

552 Buzzer tone



Permits adjustment of the buzzer tone.

Minimum	Maximum	Default
0/off	10	10

601 Regulation step



Allows the regulation of a parameter with a step that can be personalised by the operator.

Minimum	Maximum	Default
1	I _{max}	1

602 External parameter CH1, CH2, CH3, CH4



Allows the management of the external parameter 1, 2, 3, 4 (minimum value, maximum value, default value, parameter selected).

Refer to section "External controls management (Set up 602)".

705 Circuit resistance calibration



Allows the calibration of the system.

Refer to section "Circuit resistance calibration (set up 705)".

751 Current reading

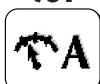

Allow the real value of the welding current to be displayed.

752 Voltage reading



Allows the real value of the welding voltage to be displayed.

758 Robot movement speed
 Allows the arm movement speed of a robot or an automation device to be displayed.

768 HI heat input measurement
 Allows reading of the value of the measurement of the heat input in welding.

801 Guard limits
 Allows the setting of the warning limits and of the guard limits.
 Allows the welding process to be controlled by setting warning limits and guard limits for the main measurable parameters.
 Allows the accurate control of the various welding phases.
 Refer to section "Guard limits (Set up 801)".

5.1.3 List of set up parameters (MIG/MAG)

0 Save and Exit
 Allows you to save the changes and exit the set up.

1 Reset
 Allows you to reset all the parameters to the default values.

2 Welding programs
Standard MIG/MAG:
 Allows selection of the manual MIG (Off) or synergic MIG (6) process by setting the type of material to be welded.
Pulsed MIG/MAG:
 Allows selection of the synergic MIG (6) process by setting the type of material to be welded.
 Allows selection of the CC/CV process.

3 Wire speed
 Allows the regulation of the wire feed rate.

Minimum	Maximum	Default
0.5 m/min	22.0 m/min	-

4 Current
 Allows the regulation of the welding current.

Minimum	Maximum
3 A	I _{max}

5 Workpiece thickness
 Allows the thickness of the part being welded to be set.
 Allows the setting of the system via the regulation of the part being welded.

6 Corner bead "a"
 Lets you set bead depth in a corner joint.

10 Pre-gas
 Allows you to set and adjust the gas flow prior to striking of the arc.
 Permits filling of the torch with gas and preparation of the environment for welding.

Minimum	Maximum	Default
0/off	99.9 s	0.1 s

11 Soft start



Permits adjustment of the wire feed speed in the phases prior to arc striking.
Permits striking at reduced speed, therefore softer and with less spatter.

Minimum	Maximum	Default
10 %	100 %	50 %

12 Motor slope

Allows you to set a gradual transition between the sparking wire speed and the welding wire speed.

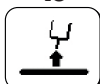
Minimum	Maximum	Default
0/off	1.0 s	0/off

15 Burn back

Permits adjustment of the wire burn time, preventing sticking at the end of welding.
Permits adjustment of the length. Permits adjustment of the length of the piece of wire outside the torch.

Minimum	Maximum	Default
-2.00	+2.00	0/syn

16 Post-gas

Permits setting and adjustment of the gas flow at the end of welding.

Minimum	Maximum	Default
0/off	99.9 s	2.0 s

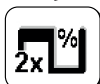
19 Duty cycle (double pulsed)

Permit adjustment of the duty cycle in double pulse.

Minimum	Maximum	Default
10 %	90 %	50 %

20 Double Pulsed MIG welding

Allows regulation of the pulsation amplitude.

Minimum	Maximum	Default
0 %	100 %	±25 %
Minimum	Maximum	Default
0.5 m/min	22 m/min	2.5 m/min

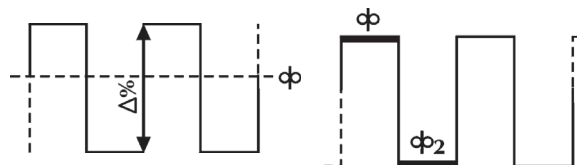
21 Pulse frequency (double pulsed)

Allows regulation of the cycle, i.e. of the impulse repetition cycle.
Allows the impulse frequency to be regulated.

Minimum	Maximum	Default
0.1 Hz	5.0 Hz	2.0 Hz

22 Secondary voltage (double pulsed)

Allows regulation of the secondary pulsation level voltage.
Makes it possible to obtain greater arc stability during the various pulsation phases.

Minimum	Maximum	Default
-5.0	+5.0	0/syn

23 Pulsed slopes (double pulsed)

Allows setting of a slope time during the pulse operation.

Minimum	Maximum	Default
1 %	100 %	50 %

24 Bilevel (4T - crater filler)

Permits adjustment of the secondary wire speed in the bilevel welding mode.

If the welder now presses and releases the button quickly, “ ϕ_2 ” can be used.

By pressing and releasing it quickly again, “ ϕ ” is used again, and so on.

Minimum	Maximum	Default
1 %	200 %	0/off

25 Initial increment



Allows regulation of the wire speed value during the first "crater-filler" welding phase. Makes it possible to increase the energy supplied to the part during the phase when the material (still cold) requires more heat in order to melt evenly.

Minimum	Maximum	Default
20 %	200 %	120 %

26 Crater filler



Allows regulation of the wire speed value during the weld closing phase. Makes it possible to reduce the energy supplied to the part during the phase when the material is already very hot, thus reducing the risk of unwanted deformations.

Minimum	Maximum	Default
20 %	200 %	80 %

27 Initial increment time



Lets you set the initial increment time. Lets you automate the "crater filler" function.

Minimum	Maximum	Default
0.1 s	99.9 s	0/off

28 Crater filler time



Lets you set the "crater filler" time. Lets you automate the "crater filler" function.

Minimum	Maximum	Default
0.1 s	99.9 s	0/off

30 Spot welding



Allows you to enable the "spot welding" process and establish the welding time.

Minimum	Maximum	Default
0.1 s	99.9 s	0/off

31 Pause point



Allows you to enable the "pause point" process and establish the pause time between one welding operation and another.

Minimum	Maximum	Default
0.1 s	99.9 s	0/off

32 Secondary voltage (MIG Bilevel)



Allows regulation of the secondary pulsation level voltage. Makes it possible to obtain greater arc stability during the various pulsation phases.

Minimum	Maximum	Default
-5.0	+5.0	0/syn

33 Secondary inductance (MIG Bilevel)



Allows regulation of the secondary pulsation level inductance. Makes it possible to obtain a quicker or slower arc to compensate for the welder's movements and for the natural welding instability.

Low inductance = reactive arc (more spatter).
High inductance = less reactive arc (less spatter).

Minimum	Maximum	Default
-30	+30	0/syn

34 Initial increase slope



Allows to set a gradual transition between the initial wire speed and the welding wire speed.

Minimum	Maximum	Default
0 s	10 s	0/off

35 Crater filler slope



Allows to set a gradual transition between the welding wire speed and crater filler wire speed.

Minimum	Maximum	Default
0 s	10 s	0/off

202 Inductance



Allows electronic regulation of the series inductance of the welding circuit.

Makes it possible to obtain a quicker or slower arc to compensate for the welder's movements and for the natural welding instability.

Low inductance = reactive arc (more spatter).

High inductance = less reactive arc (less spatter).

Minimum	Maximum	Default
-30	+30	0/syn

331 Compensated average voltage



Lets you set welding voltage.

398 Displacement speed reference constant



Reference constant for all welding processes

Value of the movement speed of the torch to which the system refers to perform the calculations of the welding parameters

399 Welding speed



Lets you set welding speed.

Default cm/min: reference speed for manual welding.

Syn: Sinergic value.

Minimum	Maximum	Default
syn min	syn max	35 cm/min

500 Machine setting



Allows the selection of the required graphic interface.

Allows access to the higher set-up levels.

Refer to section "Interface personalisation (Set up 500)"

Value	User interface	Value	Selected level
XE	Easy Mode	USER	User
XA	Advanced Mode	SERV	Service
XP	Professional Mode	vaBW	vaBW

551 Lock/unlock



Allows the locking of the panel controls and the insertion of a protection code.

Refer to section "Lock/unlock (Set up 551)".

552 Buzzer tone



Permits adjustment of the buzzer tone.

Minimum	Maximum	Default
0/off	10	10

601 Regulation step



Allows the regulation of a parameter with a step that can be personalised by the operator.

Functionality controlled by torch up/down button.

Minimum	Maximum	Default
1	lmax	1

602 External parameter CH1, CH2, CH3, CH4



Allows the management of the external parameter 1, 2, 3, 4 (minimum value, maximum value, default value, parameter selected).

Refer to section "External controls management (Set up 602)".

606 U/D torch



Allows the management of the external parameter (U/D).

Value	Default	Callback function
0/off	-	off
1/11	X	Current
	-	Program retrieval

612 DgMig Torch Setting



It allows the management of the channels of the digital torch.

Value	Default	Callback function
0/off	-	off
1/11	-	Current
2/	-	Program retrieval
3/CH3	-	CH3
4/CH4	-	CH4
5/STD	X	STD

653 Wire speed



It allow wire speed regulation (during wire loading phase).

Minimum	Maximum	Default
0.5 m/min	22.0 m/min	3.0 m/min

705 Circuit resistance calibration



Allows the calibration of the system.

Refer to section "Circuit resistance calibration (set up 705)".

751 Current reading



Allow the real value of the welding current to be displayed.

752 Voltage reading



Allows the real value of the welding voltage to be displayed.

755 Gas flow reading



Allows the real gas flow value to be displayed.

757 Wire speed reading



Allow the value of the motor encoder 1 to be displayed.

758 Robot movement speed



Allows the arm movement speed of a robot or an automation device to be displayed.

760 Current reading (motor 1)



Allow the real value of the current to be displayed (motor 1).

768 HI heat input measurement



Allows reading of the value of the measurement of the heat input in welding.

770 Deposition rate measurement



Displays deposition rate measurement.

801 Guard limits



Allows the setting of the warning limits and of the guard limits.

Allows the welding process to be controlled by setting warning limits and guard limits for the main measurable parameters.

Allows the accurate control of the various welding phases.

Refer to section "Guard limits (Set up 801)".

5.2 Specific procedures parameters

5.2.1 7 segment display personalisation

It allows you to constantly view the value of a parameter on the 7-segment display.

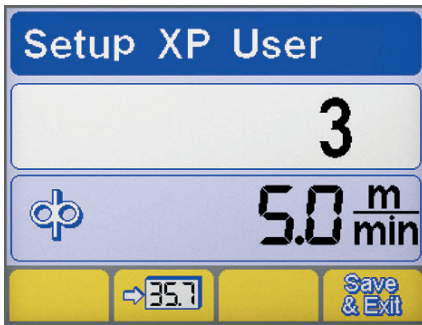

- ▶ Enter set-up by pressing the encoder button for at least 5 seconds.
- ▶ Select the required parameter by rotating the encoder.
- ▶ Store the selected parameter in the 7 segment display by pressing button **35.7**.
- ▶ Save and exit the current screen by pressing button **Save & Exit**.

5.2.2 Interface personalisation (Set up 500)

Allows the parameters to be customized on the main menu.

500 Machine setting



Allows the selection of the required graphic interface.

Value	User interface
XE	Easy Mode
XA	Advanced Mode
XP	Professional Mode

XE MODE

MIG/MAG

Welding parameters

Functions

XA MODE

MIG/MAG

Welding parameters

Functions

XP MODE

MIG/MAG

Welding parameters												
Functions												

EN

5.2.3 Lock/unlock (Set up 551)

Allows the locking of the panel controls and the insertion of a protection code.

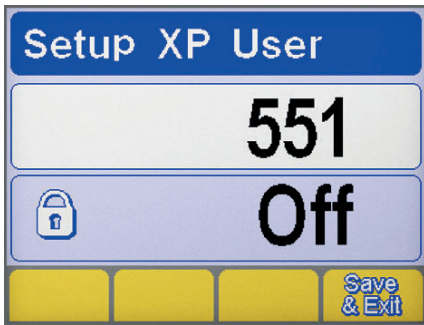

Parameter selection

- ▶ Enter set-up by pressing the encoder button for at least 5 seconds.
- ▶ Select the required parameter (551).
- ▶ Activate the regulation of the selected parameter by pressing the encoder button.

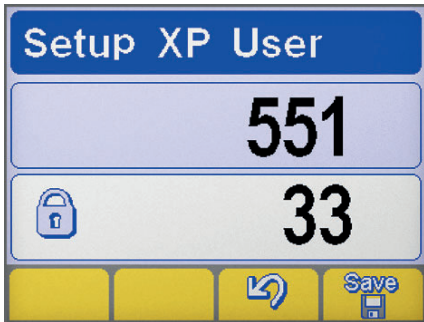

Setting the password

- ▶ Set a numerical code (password) by rotating the encoder.
- ▶ Confirm the operation by pressing the encoder key.
- ▶ Cancel the operation by pressing button
- ▶ To save the change, press the button:

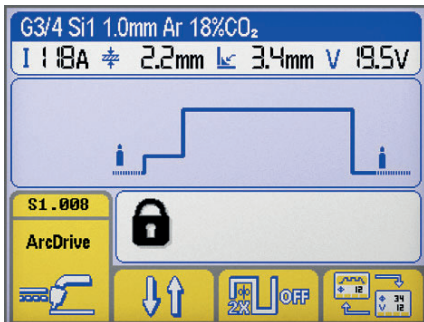

Control panel functions

- ▶ Access the panel functionalities temporarily (5 minutes) by rotating the encoder and entering the correct password.
- ▶ Confirm the operation by pressing the encoder key.
- ▶ Unlock the control panel definitively by entering set-up (follow the instructions given above) and bring back parameter 551 to "off".
- ▶ Confirm the operation by pressing the encoder key.
- ▶ To save the change, press the button:

5.2.4 External controls management (Set up 602)

Allows the management of the external parameter 2 (minimum value, maximum value, default value, parameter selected).

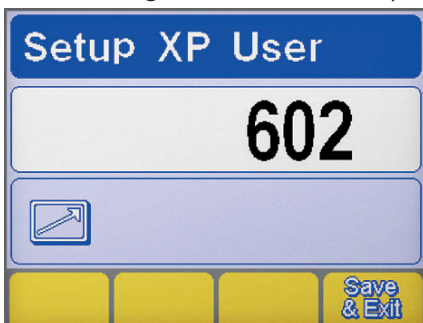

Parameter selection

- ▶ Enter set-up by pressing the encoder button for at least 5 seconds.
- ▶ Select the required parameter (602).
- ▶ Enter the "External controls management" screen by pressing the encoder button.

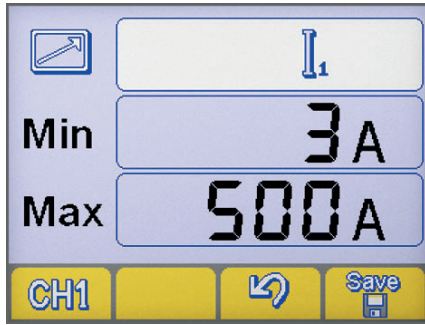

External controls management

- ▶ Select the required RC remote control output (CH1, CH2, CH3, CH4) by pressing button
- ▶ Select the required parameter (Min-Max-parameter) by pressing the encoder button.
- ▶ Adjust the required parameter (Min-Max-parameter) by rotating the encoder.
- ▶ To save the change, press the button:
- ▶ Cancel the operation by pressing button

5.2.5 Circuit resistance calibration (set up 705)

Allows to calibrate the generator on the current welding circuit resistance.

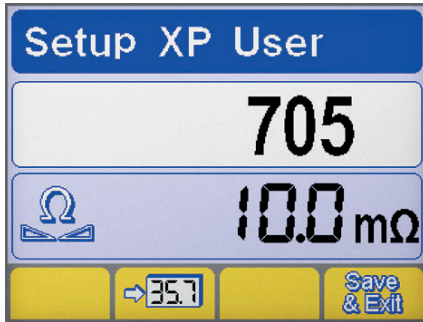

Parameter selection

- ▶ Enter set-up by pressing the encoder button for at least 5 seconds.
- ▶ Select the required parameter (705).
- ▶ Activate the regulation of the selected parameter by pressing the encoder button.
- ▶ Connect the generator to the welding circuit (bench or piece).
- ▶ Remove the cap to put the nozzle holder tip of the exposed torch. (MIG/MAG)

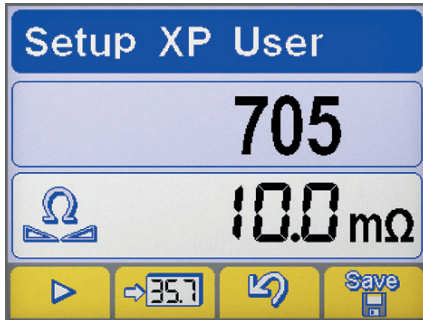

Calibration

- ▶ Place the tip of the wire guide in electrical contact with the work piece. (MIG/MAG)
- ▶ Press the button to start the procedure.
- ▶ Maintain contact for at least one second.
- ▶ The value shown on the display will update after calibration.
- ▶ Confirm the operation by pressing button
- ▶ Cancel the operation by pressing button
- ▶ To save the change and exit the set up, press the key:

5.2.6 Guard limits (Set up 801)

Allows the setting of the warning limits and of the guard limits.

Allows the welding process to be controlled by setting warning limits and guard limits for the main measurable parameters.

Allows the accurate control of the various welding phases.

Refer to section "Guard limits (Set up 801)".

Warning limits				Guard limits			
	Welding current				Welding voltage		
	Gas flow reading				Robot movement speed		
	Current reading (motor 1)				Current reading (motor 2)		
	Coolant flow reading				Wire speed reading		
	Coolant temperature reading						

EN

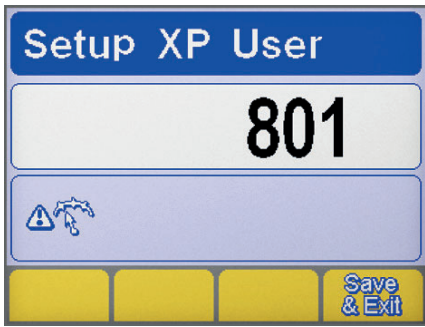

Parameter selection

- ▶ Enter set-up by pressing the encoder button for at least 5 seconds.
- ▶ Select the required parameter (801).
- ▶ Enter the "Guard limits" screen by pressing the encoder button.

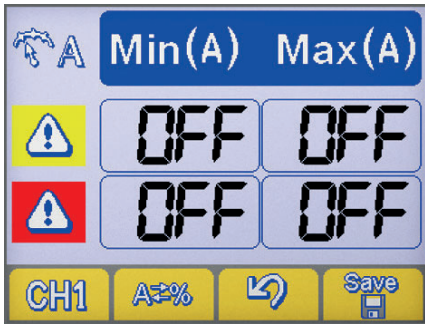

Parameter selection

- ▶ Select the required parameter by pressing button **CH1**.
- ▶ Select the method of setting the guard limits by pressing button **A=%**.

Mode selection

A/V Absolute value **%** Percentage value

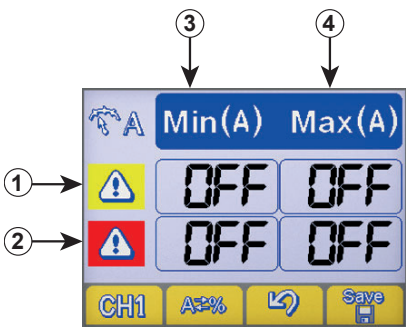

Guard limits setting

- 1 Warning limits line
- 2 Alarm limits line
- 3 Minimum levels column
- 4 Maximum levels column

- ▶ Select the required box by pressing the encoder key (the selected box is displayed with reverse contrast).
- ▶ Adjust the level of the selected limit by rotating the encoder.
- ▶ To save the change, press the button: **Save**.



- ▶ Passing one of the warning limits causes a visual signal to appear on the control panel.
- ▶ Passing one of the alarm limits causes a visual signal to appear on the control panel and the immediate blockage of the welding operations.
- ▶ It is possible to set start and end of welding filters to prevent error signals during the striking and extinction of the arc (consult the "Set up" section - Parameters 802-803-804).

6. ACCESSORIES

Kit RC (WF... Steeldrive)
73.11.015

Push-Pull kit
73.11.012

Feed unit big wheels - upgrade kit
73.10.073

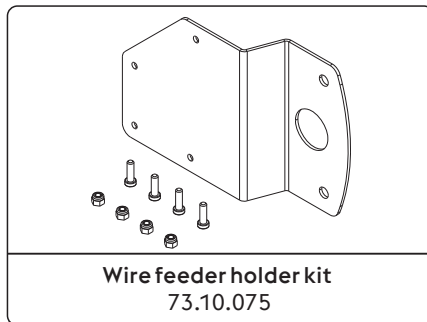
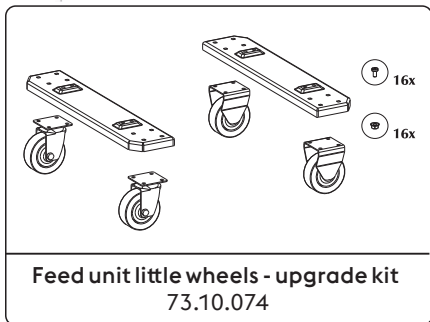

*Factory assembly
Consult the "Installation kit/accessories" section.

7. MAINTENANCE



Routine maintenance must be carried out on the system according to the manufacturer's instructions. When the equipment is working, all the access and operating doors and covers must be closed and locked. The system must not be modified in any way. Prevent conductive dust from accumulating near the louvers and over them.



Any maintenance operation must be performed by qualified personnel only. The repair or replacement of any parts in the system by unauthorised personnel will invalidate the product warranty. The repair or replacement of any parts in the system must be carried out only by qualified personnel.



Disconnect the power supply before every operation!

7.1 Carry out the following periodic checks on the power source



Clean the power source inside by means of low-pressure compressed air and soft bristle brushes. Check the electric connections and all the connection cables.

7.2 Responsibility



Failure to carry out the above maintenance will invalidate all warranties and exempt the manufacturer from any liability. The manufacturer disclaims any responsibility if the user fails to follow these instructions. For any doubts and/or problems do not hesitate to contact your nearest customer service centre.

8. ALARM CODES



ALARM

Activation of an alarm or the passing of any critical limit causes a visual signal to appear on the control panel and the immediate shut-down of welding operations.



CAUTION





























Exceeding a guard limit causes a visual signal on the control panel but allows the welding operations to continue.

All the alarms and all the guard limits relating to the system are listed below.

E01	Overtemperature		E02	Overtemperature	
E05	Overcurrent		E07	Wire feeder motor power supply fault	
E08	Blocked motor		E10	Power module overcurrent (Inverter)	
E12.1	Communication error WF1		E13	Communication error (FP)	

EN

E14.xx	Invalid program the error sub-code indicates the number of the deleted job		E15	Invalid program	
E16.1	Communication error RI 1000/2000/3000 (CAN bus)		E16.2	Communication error RI 3000 (Modbus)	
E16.3	Communication error RI 1000/2000		E18.xx	Invalid program the error sub-code indicates the number of the deleted job	
E19	System configuration error		E19.1	System configuration error	
E19.11	System configuration error (WF)		E20	Memory fault	
E21	Data loss		E23	Welding programs not present	
E27	Memory fault (RTC)		E32	Data loss	
E33.1	System configuration error (LCD 3.5")		E33.3	Communication error (ACTIVATION KEY)	
E33.4	Communication error (ACTIVATION KEY)		E40	System power supply fault	
E43	Coolant shortage		E44	Gas shortage	
E48	Wire out (Automation and robotics)		E50	Wire stuck (Automation and robotics)	
E54	Current level exceeded (Lower limit)		E55	Current level exceeded (Upper limit)	
E56	Voltage level exceeded (Lower limit)		E57	Voltage level exceeded (Upper limit)	
E58	Gas flow level exceeded (Lower limit)		E59	Gas flow level exceeded (Upper limit)	
E62	Current level exceeded (Lower limit)		E63	Current level exceeded (Upper limit)	
E64	Voltage level exceeded (Lower limit)		E65	Voltage level exceeded (Upper limit)	
E66	Gas flow level exceeded (Lower limit)		E67	Gas flow level exceeded (Upper limit)	

 E71	Coolant overtemperature		 E74	Motor 1 current level exceeded	
 E76	Liquid coolant flow level exceeded		 E77	Coolant temperature level exceeded	
 E80	Wire out (wire end)		 E81	Overcurrent (WU pump)	
 E82	Communication error (WU)		 E83	Pump blocked	
 E99.2	System configuration alarm (inverter)		 E99.3	System configuration alarm (FP)	
 E99.4	System configuration alarm (FP)		 E99.5	System configuration alarm (FP)	
 E99.6	System configuration alarm		 E99.11	Memory fault	

9. TROUBLESHOOTING

Wire feeder fails

Cause	Solution
» Faulty torch trigger button.	» Replace the faulty component. » Contact the nearest service centre to have the system repaired.
» Incorrect or worn rollers.	» Replace the rollers.
» Faulty wire feeder.	» Replace the faulty component. » Contact the nearest service centre to have the system repaired.
» Damaged torch liner.	» Replace the faulty component. » Contact the nearest service centre to have the system repaired.
» No power supply to the wire feeder.	» Check the connection to the power source. » Read the paragraph "Connections". » Contact the nearest service centre to have the system repaired.
» Tangled wire on the spool.	» Untangle the wire or replace the wire spool.
» Melted torch nozzle (wire stuck)	» Replace the faulty component.

Irregular wire feeding

Cause	Solution
» Faulty torch trigger button.	» Replace the faulty component. » Contact the nearest service centre to have the system repaired.
» Incorrect or worn rollers.	» Replace the rollers.
» Faulty wire feeder.	» Replace the faulty component. » Contact the nearest service centre to have the system repaired.
» Damaged torch liner.	» Replace the faulty component. » Contact the nearest service centre to have the system repaired.
» Incorrect spindle clutch or misadjusted rolls locking devices.	» Release the clutch. » Increase the rolls locking pressure.

Slag inclusions

Cause

- » Poor cleanliness.
- » Electrode diameter too big.
- » Incorrect edge preparation.
- » Incorrect welding mode.

Solution

- » Clean the pieces accurately before welding.
- » Use a smaller diameter electrode.
- » Increase the chamfering.
- » Decrease the distance between the electrode and the piece.
- » Move regularly during all the welding operations.

Blowholes

Cause

- » Insufficient shielding gas.

Solution

- » Adjust the air flow.
- » Check that the diffuser and the gas nozzle of the torch are in good condition.

Sticking

Cause

- » Incorrect arc length.
- » Incorrect welding parameters.
- » Incorrect welding mode.
- » Pieces to be welded too big.
- » Incorrect arc regulation.

Solution

- » Increase the distance between the electrode and the piece.
- » Increase the welding voltage.
- » Increase the welding current.
- » Increase the welding voltage.
- » Angle the torch more.
- » Increase the welding current.
- » Increase the welding voltage.
- » Increase the equivalent circuit inductive value setting.

Undercuts

Cause

- » Incorrect welding parameters.
- » Incorrect arc length.
- » Incorrect welding mode.
- » Insufficient shielding gas.

Solution

- » Decrease the welding current.
- » Decrease the distance between the electrode and the piece.
- » Decrease the welding voltage.
- » Decrease the side oscillation speed while filling.
- » Decrease the travel speed while welding.
- » Use gases suitable for the materials to be welded.

Oxidations

Cause

- » Insufficient shielding gas.

Solution

- » Adjust the air flow.
- » Check that the diffuser and the gas nozzle of the torch are in good condition.

Porosity

Cause

- » Grease, varnish, rust or dirt on the workpieces to be welded.
- » Grease, varnish, rust or dirt on the filler material.
- » Humidity in the filler metal.
- » Incorrect arc length.
- » Humidity in the welding gas.

Solution

- » Clean the pieces accurately before welding.
- » Always use quality materials and products.
- » Keep the filler metal always in perfect condition.
- » Always use quality materials and products.
- » Keep the filler metal always in perfect condition.
- » Decrease the distance between the electrode and the piece.
- » Decrease the welding voltage.
- » Always use quality materials and products.
- » Ensure the gas supply system is always in perfect condition.

» Insufficient shielding gas.

- » Adjust the air flow.
- » Check that the diffuser and the gas nozzle of the torch are in good condition.

» The weld pool solidifies too quickly.

- » Decrease the travel speed while welding.
- » Pre-heat the workpieces to be welded.
- » Increase the welding current.

Hot cracks

Cause

- » Incorrect welding parameters.
- » Grease, varnish, rust or dirt on the workpieces to be welded.
- » Grease, varnish, rust or dirt on the filler material.
- » Incorrect welding mode.
- » Pieces to be welded have different characteristics.

Solution

- » Decrease the welding current.
- » Clean the pieces accurately before welding.
- » Always use quality materials and products.
- » Keep the filler metal always in perfect condition.
- » Carry out the correct sequence of operations for the type of joint to be welded.
- » Carry out buttering before welding.

Cold cracks

Cause

- » Humidity in the filler metal.
- » Particular geometry of the joint to be welded.

Solution

- » Always use quality materials and products.
- » Keep the filler metal always in perfect condition.
- » Pre-heat the workpieces to be welded.
- » Carry out post-heating.
- » Carry out the correct sequence of operations for the type of joint to be welded.

10. OPERATING INSTRUCTIONS

10.1 Continuous wire welding (MIG/MAG)

Introduction

A MIG system consists of a direct current power source, wire feeder, wire spool, torch and gas.

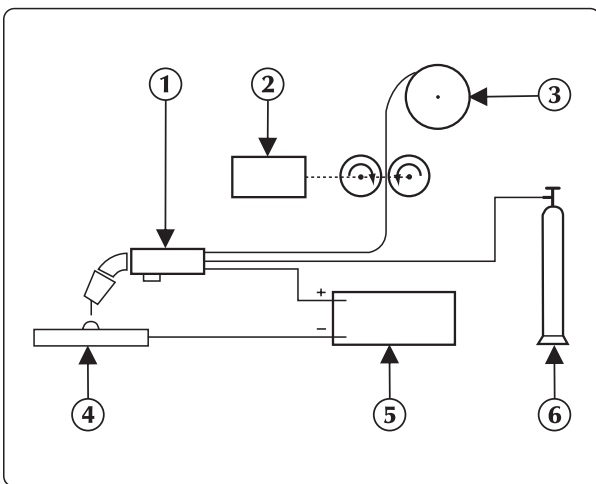

MIG manual welding system

The current is transferred to the arc through the fusible electrode (wire connected to positive pole); In this procedure the melted metal is transferred onto the workpiece through the arc stream.

The current is transferred to the arc through the fusible electrode (wire connected to positive pole); in this procedure the melted metal is transferred onto the workpiece through the arc stream. The automatic feeding of the continuous filler material electrode (wire) is necessary to refill the wire that has melted during welding.

1. Torch
2. Wirefeeder
3. Welding wire
4. Workpiece
5. Power source
6. Cylinder

EN

Methods

In MIG welding, two main metal transfer mechanisms are present and they can be classified according to the means by which metal is transferred from the electrode to the workpiece.

The first process, called "SHORT-ARC", starts with the electrode in direct contact with the weld pool, producing a short circuit that melts the wire. The short circuit is then broken, re-igniting the arc and repeating the cycle.

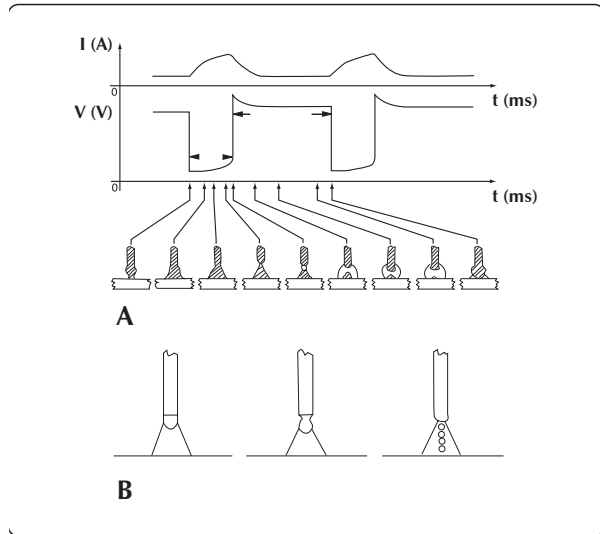

SHORT cycle and SPRAY ARC welding

Another mechanism for metal transfer is called the "SPRAY-ARC" method, where the metal transfer occurs in the form of very small drops that are formed and detached from the tip of the wire and transferred to the weld pool through the arc stream (Fig. 2b).

Welding parameters

The visibility of the arc reduces the need for the user to strictly observe the adjustment tables as he can directly monitor the weld pool.

- Voltage directly affects the appearance of the weld bead, but its dimensions can be varied to suit requirements by manually moving the torch to vary the size of the bead at a constant voltage.
- The wire feeding speed is proportional to the welding current.

The two figures show the relationships between the various welding parameters.

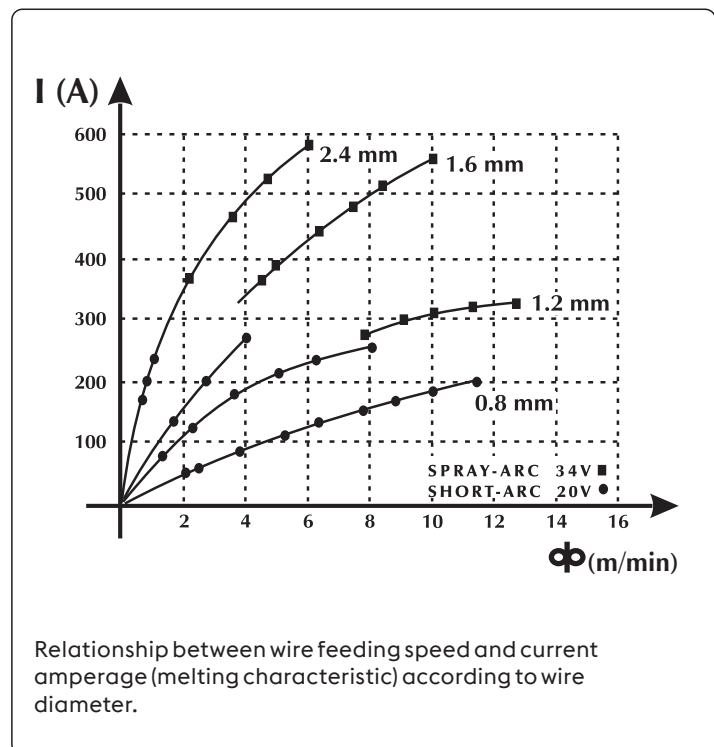
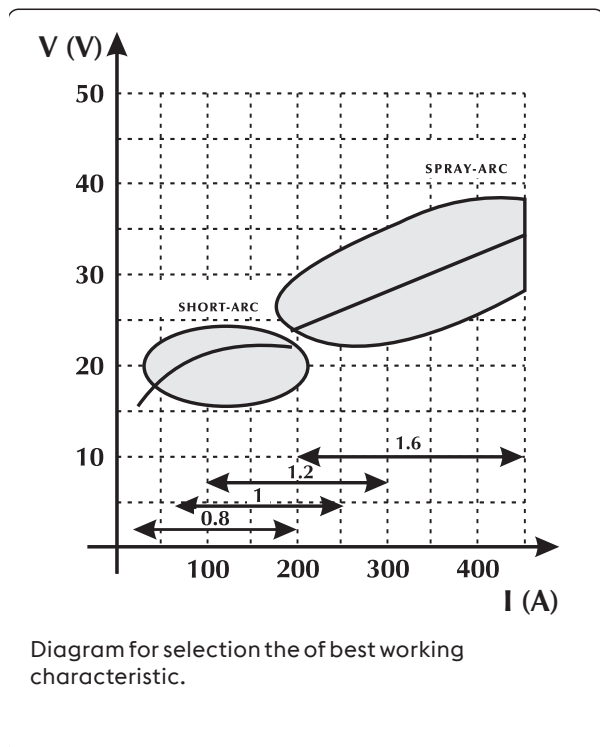

Selection guide of welding parameters with reference to the most typical applications and most commonly used wires.

Voltage arc	Ø 0,8 mm	Ø 1,0-1,2 mm	Ø 1,6 mm	Ø 2,4 mm
16V - 22V SHORT - ARC				
	60 - 160 A Low penetration for thin materials	100 - 175 A Good penetration and melting control	120 - 180 A Good flat and vertical melting	150 - 200 A Not used
24V - 28V GLOBULAR-ARC (Transition area)				
	150 - 250 A Automatic fillet welding	200 - 300 A Automatic welding with high voltage	250 - 350 A Automatic welding downwards	300 - 400 A Not used
30V - 45V SPRAY - ARC				
	150 - 250 A Low penetration with adjustment to 200 A	200 - 350 A Automatic welding with multiple runs	300 - 500 A Good penetration downwards	500 - 750 A Good penetration, high deposit on thick materials

Unalloyed steel

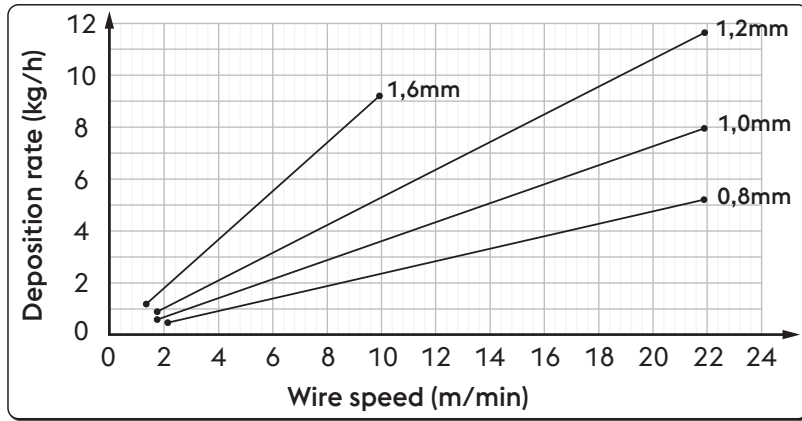

Ø	Wire speed	Deposition rate
0,8 mm	2,0 m/min	0,5 kg/h
	22,0 m/min	5,3 kg/h
1,0 mm	1,6 m/min	0,6 kg/h
	22,0 m/min	8,1 kg/h
1,2 mm	1,6 m/min	0,9 kg/h
	22,0 m/min	11,7 kg/h
1,6 mm	1,2 m/min	1,1 kg/h
	10,0 m/min	9,4 kg/h

High alloyed steel

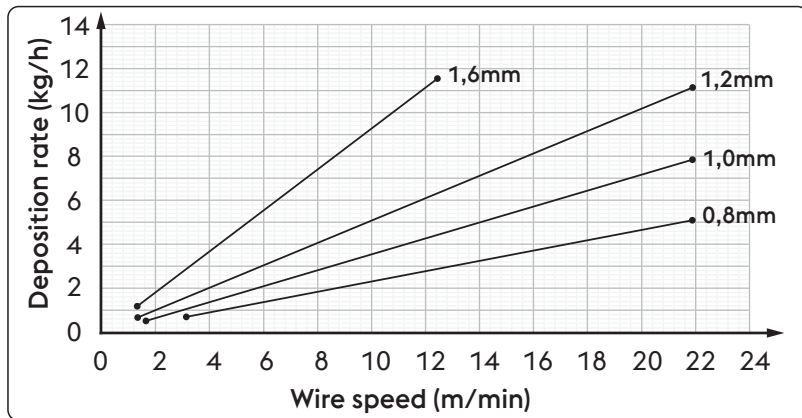

Ø	Wire speed	Deposition rate
0,8 mm	2,0 m/min	0,5 kg/h
	22,0 m/min	5,3 kg/h
1,0 mm	1,6 m/min	0,6 kg/h
	22,0 m/min	8,1 kg/h
1,2 mm	1,6 m/min	0,9 kg/h
	22,0 m/min	11,7 kg/h
1,6 mm	1,2 m/min	1,1 kg/h
	10,0 m/min	9,4 kg/h

Aluminum alloy

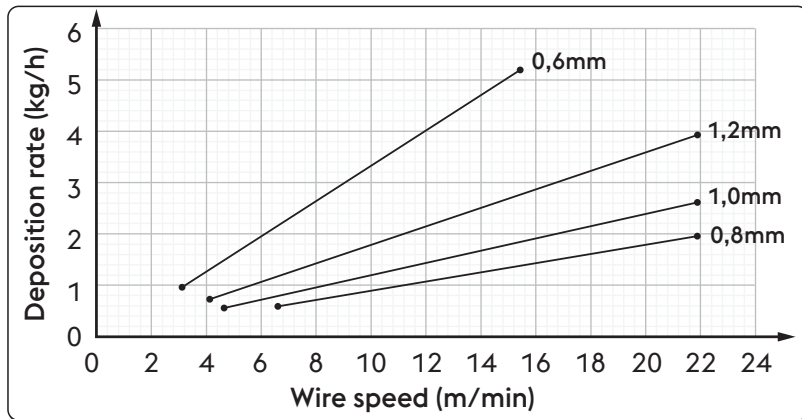

Ø	Wire speed	Deposition rate
0,8 mm	6,5 m/min	0,6 kg/h
	22,0 m/min	2,0 kg/h
1,0 mm	4,5 m/min	0,5 kg/h
	22,0 m/min	2,6 kg/h
1,2 mm	4,0 m/min	0,7 kg/h
	22,0 m/min	4,0 kg/h
1,6 mm	3,0 m/min	0,9 kg/h
	15,5 m/min	5,2 kg/h

EN

Gases

MIG-MAG welding is defined mainly by the type of gas used: inert for MIG welding (Metal Inert Gas), active for MAG welding (Metal Active Gas).

- Carbon dioxide (CO₂)

Using CO₂ as shielding gas gives high penetration and a high feed speed, resulting in good mechanical properties and low operating costs. On the other hand, CO₂ causes considerable problems with the final chemical composition of the joints as it removes easily oxidisable elements and simultaneously enriches the carbon content of the weld pool.

Welding with pure CO₂ also creates other types of problems such as excessive spatter and the formation of carbon monoxide porosity.

- Argon

This inert gas is used in pure form to weld light alloys but is best mixed with oxygen and CO₂ in a percentage of 2% to weld chrome-nickel stainless steels, as this contributes to the stability of the arc and improves the form of the bead.

- Helium

This gas is used as an alternative to argon and permits greater penetration (on thick material) and faster wire feeding.

- Argon-Helium mixture

Provides a more stable arc than pure helium, and greater penetration and travel speed than argon.

- Argon-CO₂ and Argon-CO₂-Oxygen mixture

These mixtures are used in the welding of ferrous materials especially in SHORT-ARC operating mode as they improve the specific heat contribution.

They can also be used in SPRAY-ARC.

Normally the mixture contains a percentage of CO₂ ranging from 8% to 20% and O₂ around 5%.

Consult the instruction manual of the system.





Unalloyed steel / High alloyed steel		Aluminum alloy	
Current range	Gas flow	Current range	Gas flow
3-50 A	10-12 l/min	3-50 A	10-12 l/min
30-100 A	10-14 l/min	30-100 A	10-15 l/min
75-150 A	12-16 l/min	75-150 A	12-18 l/min
150-250 A	14-18 l/min	150-250 A	14-22 l/min
250-400 A	16-20 l/min	250-400 A	16-25 l/min
400-500 A	18-22 l/min	400-500 A	18-30 l/min

11. TECHNICAL SPECIFICATIONS

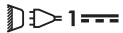

EN

Wire feeder characteristics WF NX 430 SteelDrive		U.M.
Wire feeder	SL4R-4T	
Wire feeder rated power	120	W
No rolls	4	
Wire diameter / Standard roller	1.0-1.2	mm
Wire diameters / Tractable rollers	Wire speed 0.8-1.6 mm aluminium wire 1.2-2.4 flux-core wire	mm/Material
Gas test button	yes	
Wire feed button	yes	
Wire backward push button	no	
Wire speed	25 Ø 0.8 - 1.0	m/min
Synergic programs	yes	
External devices	yes (optional)	
Connector for Push-Pull torch	yes (optional)	
Coil	200/300	mm
Diameter of front wheels	63/125 (optional)	mm
Diameter of rear wheels	63/125 (optional)	mm
Electrical characteristics WF NX 430 SteelDrive		U.M.
Power supply voltage U1	48	Vdc
Communication bus	DIGITAL	
Max. input current I1max	4.5	A
Duty factor WF NX 430 SteelDrive		U.M.
Duty factor (40°C)		
(X=50%)	500	A
(X=60%)	470	A
(X=100%)	420	A
Duty factor (25°C)		
(X=80%)	500	A
(X=100%)	470	A
Physical characteristics WF NX 430 SteelDrive		U.M.
IP Protection rating	IP23S	
Dimensions (lxdxh)	640x250x460	mm
Weight	19.0	Kg
Manufacturing Standards	EN IEC 60974-5:2019 EN 60974-10/A1:2015	

12. RATING PLATE

 VOESTALPINE BÖHLER WELDING SELCO S.R.L. Via Palladio, 19 - ONARA (PADOVA) - ITALY			
WF NX 430		N°	
EN 60974-5:2019 IEC 60974-10/A1:2015 Class A			
	X (40°C)	60%	100%
	I₂	500A	400A
	U₁ 48V	I_{1max} 4.5A	
IP 23 S		UK CA   EAC	
MADE IN ITALY 			

13. MEANING RATING PLATE

1		2	
3		4	
5			
	6	6A	6B
	7	7A	7B
8	9	10	
11		UK CA   EAC	
MADE IN ITALY 			

- 1 Trademark
- 2 Name and address of manufacturer
- 3 Machine model
- 4 Serial no.
 XXXXXXXXXXXX Year of manufacture
- 5 Reference to construction standards
- 6 Intermittent cycle symbol
- 7 Rated welding current symbol
- 6A Intermittent cycle values
- 6B Intermittent cycle values
- 7A Rated welding current values
- 7B Rated welding current values
- 8 Power supply symbol
- 9 Rated power supply voltage
- 10 Maximum rated power supply current
- 11 Protection rating

CE EU declaration of conformity
 EAC EAC declaration of conformity
 UKCA UKCA declaration of conformity

EN

EN

EU-KONFORMITÄTSERKLÄRUNG

Der Bauarbeiter

voestalpine Böhler Welding Selco S.r.l. - Via Palladio, 19 - 35019 Onara di Tombolo (PD) - ITALY
Tel. +39 049 9413/111 - Fax +39 049 9413/311 - www.voestalpine.com/welding

erklärt unter seiner alleinigen Verantwortung, dass das folgende Produkt:

WF NX 430 STEELDRIVE

71.01.083

den folgenden EU Richtlinien entspricht:

2014/35/EU LOW VOLTAGE DIRECTIVE

2014/30/EU EMC DIRECTIVE

2011/65/EU RoHS DIRECTIVE

dass die folgenden harmonisierten Normen angewendet wurden:

EN IEC 60974-5:2019

WIRE FEEDERS

EN 60974-10/A1:2015

ELECTROMAGNETIC COMPATIBILITY REQUIREMENTS

Die Dokumentation, die die Einhaltung der Richtlinien bescheinigt, wird beim oben genannten Hersteller für Inspektionen aufbewahrt.

Jede von der Firma voestalpine Böhler Welding Selco S.r.l. nicht genehmigte Änderung hebt die Gültigkeit dieser Erklärung auf.

Onara di Tombolo, 03/07/2023

voestalpine Böhler Welding Selco s.r.l.

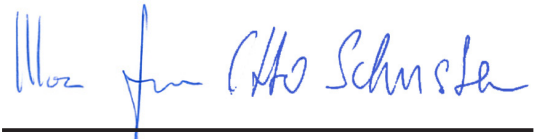

Mirco Frasson

Otto Schuster

Managing Directors

INDEX

1. WARNUNG	81
1.1 Arbeitsumgebung	81
1.2 Persönlicher Schutz und Schutz Dritter.....	81
1.3 Rauch- und Gasschutz.....	82
1.4 Brand-/Explosionsverhütung.....	82
1.5 Schutzmaßnahmen im Umgang mit Gasflaschen.....	83
1.6 Schutz vor Elektrischem Schlag.....	83
1.7 Elektromagnetische Felder und Störungen	83
1.8 Schutzart IP	84
1.9 Entsorgung	84
2. INSTALLATION	84
2.1 Heben, Transportieren und Abladen.....	85
2.2 Aufstellen der Anlage.....	85
2.3 Elektrischer Anschluss.....	85
2.4 Inbetriebnahme	85
3. PRÄSENTATION DER ANLAGE.....	87
3.1 Hintere Tafel.....	87
3.2 Buchsenfeld.....	87
3.3 Frontbedienfeld.....	88
4. VERWENDUNG VON GERÄTEN	89
4.1 Startbildschirm	89
4.2 Test-Anzeige.....	89
4.3 Haupt-Menü	89
5. SETUP.....	93
5.1 Setup und Parametereinstellung.....	93
5.2 Spezielle Verfahren zur Verwendung der Parameter	102
6. ZUBEHÖR.....	105
7. WARTUNG	106
7.1 Führen Sie folgende regelmäßige Überprüfungen am Generator durch.....	106
7.2 Verantwortung.....	106
8. ALARMCODES	106
9. FEHLERSUCHE.....	108
10. BETRIEBSANWEISUNGEN	110
10.1 Schweißen mit Endlosdrahtelektroden (MIG/MAG).....	110
11. TECHNISCHE DATEN	115
12. LEISTUNGSSCHILDER	116
13. BEDEUTUNG DER ANGABEN AUF DEM LEISTUNGSSCHILD	116
14. SCHALTPLAN	459
15. VERBINDER	460
16. ERSATZTEILVERZEICHNIS.....	461
17. INSTALLATION KITS/ZUBEHÖR	464

SYMBOLE



Drohende Gefahren, die schwere Verletzungen verursachen und gefährliche Verhaltensweisen, die zu schweren Verletzungen führen können.



Verhaltensweisen, die leichte Verletzungen oder Sachschäden verursachen könnten.



Die mit diesem Symbol gekennzeichneten Anmerkungen sind technischer Art und erleichtern die Arbeitsschritte.

1. WARNUNG



Vor Arbeitsbeginn lesen Sie das Anleitungsheft sorgfältig durch und vergewissern Sie sich, ob Sie alles richtig verstanden haben.

Nehmen Sie keine Änderungen vor und führen Sie keine hier nicht beschriebenen Instandhaltungsarbeiten durch. Der Hersteller haftet nicht für Personen- oder Sachschäden, die durch unsachgemäßen Gebrauch oder Nichteinhaltung der Vorgaben dieser Anleitung seitens des Benutzers verursacht werden.

Die Bedienungsanleitung ist ständig am Einsatzort des Gerätes aufzubewahren. Ergänzend zur Bedienungsanleitung sind die allgemein gültigen sowie die örtlichen Regeln zu Unfallverhütung und Umweltschutz zu beachten.



Alle Personen, die mit der Inbetriebnahme, Bedienung, Wartung und Instandhaltung des Gerätes zu tun haben, müssen:

- entsprechend qualifiziert sein
- Kenntnisse vom Schweißen haben
- diese Bedienungsanleitung vollständig lesen und genau befolgen

Bei Fragen oder Unklarheiten im Umgang mit dem Gerät wenden Sie sich an Fachpersonal.

DE

1.1 Arbeitsumgebung



Die gesamte Anlage darf ausschließlich für den Zweck verwendet werden, für den sie konzipiert wurde, auf die Art und in dem Umfang, der auf dem Leistungsschild und/oder im vorliegenden Handbuch festgelegt ist und gemäß den nationalen und internationalen Sicherheitsvorschriften. Ein anderer Verwendungszweck, als der ausdrücklich vom Hersteller angegebene, ist unsachgemäß und gefährlich. Der Hersteller übernimmt in solchen Fällen keinerlei Haftung.



Dieses Gerät darf nur für gewerbliche Zwecke im industriellen Umfeld angewendet werden. Der Hersteller haftet nicht für Schäden, die durch den Gebrauch der Anlage im Haushalt verursacht wurden.



Die Anlage darf nur bei Umgebungstemperaturen zwischen -10°C und +40°C (zwischen +14°F und +104°F) benutzt werden.

Die Anlage darf nur bei Umgebungstemperaturen zwischen -25°C und +55°C (zwischen -13°F und 131°F) befördert und gelagert werden.

Die Anlage darf nur in einer Umgebung benutzt werden, die frei von Staub, Säure, Gas und ätzenden Substanzen ist.

Die Anlage darf nicht in einer Umgebung mit einer relativen Luftfeuchte über 50% bei 40°C (104°F) benutzt werden.

Die Anlage darf nicht in einer Umgebung mit einer relativen Luftfeuchte über 90% bei 20°C (68°F) benutzt werden.

Die Anlage darf nicht in einer Höhe von mehr als 2000m über NN (6500 Fuß) benutzt werden.



Verwenden Sie das Gerät nicht, um Rohre aufzutauen.

Verwenden Sie das Gerät nicht, um Batterien und/oder Akkus aufzuladen.

Verwenden Sie das Gerät nicht, um Starthilfe an Motoren zu geben.

1.2 Persönlicher Schutz und Schutz Dritter



Der Schweißvorgang verursacht schädliche Strahlungs-, Lärm-, Hitze- und Gasemissionen. Erstellen Sie eine feuerfeste Trennwand, um den Schweißbereich vor Strahlen, Funken und leichter Schlacke zu schützen. Anwesende dritte Personen darauf hinweisen, nicht in den Schweißlichtbogen oder das glühende Metall zu schauen und sich ausreichend zu schützen.



Schutzkleidung anziehen, um die Haut vor Lichtbogenstrahlung, Funken und glühend heißem Metall zu schützen. Die getragene Kleidung muss den ganzen Körper bedecken und wie folgt beschaffen sein:

- unversehrt und in gutem Zustand
- feuerfest
- isolierend und trocken
- am Körper anliegend und ohne Aufschläge



Immer normgerechtes, widerstandsfähiges und wasserfestes Schuhwerk tragen.

Immer normgerechte Handschuhe tragen, die die elektrische und thermische Isolierung gewährleisten.



Masken mit seitlichem Gesichtsschutz und geeignetem Schutzfilter (mindestens Schutzstufe 10 oder höher) für die Augen tragen.



Immer Schutzbrillen mit Seitenschutz aufsetzen, insbesondere beim manuellen oder mechanischen Entfernen der Schweißschlacke.



Keine Kontaktlinsen tragen!



Gehörschutz tragen, wenn ein gefährlicher Lärmpegel beim Schweißen erreicht wird. Wenn der Geräuschpegel die gesetzlich festgelegten Grenzwerte überschreitet, den Arbeitsbereich abgrenzen und prüfen, ob die Personen, die diesen Bereich betreten, Gehörschutz tragen.



Die Seitenpaneele beim Schweißen immer geschlossen halten. Die Anlage darf keiner Änderung unterzogen werden. Den Kontakt von Händen, Haaren, Kleidung, Werkzeugen usw. mit sich bewegenden Teilen vermeiden, wie: ventilatoren, zahnradern, rollen und wellen, drahtspulen. Die Zahnräder bei laufendem Drahtvorschubgerät nicht berühren. Umgehen/Überbrücken der Schutzvorrichtungen an Drahtvorschubgeräten ist besonders gefährlich und befreit den Hersteller von jeglicher Haftung für Personen- und Sachschäden.



Den Kopf während des Ladens und Vorschubs des Drahts fern vom MIG/MAG-Brenner halten. Der austretende Draht kann ernsthafte Verletzungen an Händen, Gesicht und Augen verursachen.



Soeben geschweißte Werkstücke nicht berühren: die Hitze kann schwere Verbrennungen verursachen. Alle oben beschriebenen Sicherheitsvorschriften auch bei den Arbeitsschritten nach dem Schweißen berücksichtigen, da sich Zunder von den bearbeiteten und sich abkühlenden Werkstücken ablösen kann.



Sicherstellen, dass der Brenner abgekühlt ist, bevor daran Arbeiten oder Wartungen ausgeführt werden.



Sicherstellen, dass das Kühlaggregat ausgeschaltet ist, bevor die Leitungen für den Vor- und Rücklauf der Kühlflüssigkeit abgetrennt werden. Die austretende heiße Flüssigkeit kann schwere Verbrennungen verursachen.



Einen Verbandskasten griffbereit halten. Verbrennungen oder Verletzungen sind nicht zu unterschätzen.



Vor dem Verlassen des Arbeitsplatzes muss dieser gesichert werden, um Personen- und Sachschäden zu vermeiden.

1.3 Rauch- und Gasschutz



Rauch, Gas und Staub, die durch das Schweißverfahren entstehen, können gesundheitsschädlich sein. Der beim Schweißen entstehende Rauch kann unter bestimmten Umständen Krebs oder bei Schwangeren Auswirkungen auf das Ungeborene verursachen.

- Den Kopf fern von Schweißgasen und Schweißrauch halten.
- Im Arbeitsbereich für eine angemessene natürliche Lüftung bzw. Zwangsbelüftung sorgen.
- Bei ungenügender Belüftung sind Masken mit Atemgerät zu tragen.
- Wenn Schweißarbeiten in engen Räumen durchgeführt werden, sollte der Schweißer von einem außerhalb dieses Raums stehenden Kollegen beaufsichtigt werden.
- Wichtiger Hinweis: Keinen Sauerstoff für die Lüftung verwenden.
- Die Wirksamkeit der Absaugung überprüfen, indem die abgegebene Schadgasmenge regelmäßig mit den laut Sicherheitsvorschriften zulässigen Werten verglichen wird.
- Die Menge und Gefährlichkeit des erzeugten Schweißrauchs hängt vom benutzten Grundmaterial, vom Zusatzmaterial und den Stoffen ab, die man zur Reinigung und Entfettung der Werkstücke benutzt. Die Anweisungen des Herstellers und die entsprechenden technischen Datenblätter genau befolgen.
- Keine Schweißarbeiten in der Nähe von Entfettungs- oder Lackierarbeiten durchführen.
- Die Gasflaschen nur im Freien oder in gut belüfteten Räumen aufstellen.

1.4 Brand-/Explosionsverhütung



Das Schweißverfahren kann Feuer und/oder Explosionen verursachen.

- Alle entzündlichen bzw. brennbaren Stoffe oder Gegenstände aus dem Arbeitsbereich und aus dem umliegenden Bereich entfernen.
- Entzündliches Material muss mindestens 11m (35 Fuß) vom Ort, an dem geschweißt wird, entfernt sein oder entsprechend geschützt werden.
- Sprühende Funken und glühende Teilchen können leicht verstreut werden und benachbarte Bereiche auch durch kleine Öffnungen erreichen. Seien Sie beim Schutz von Personen und Gegenständen besonders aufmerksam.
- Keine Schweiß- oder Schneidarbeiten über oder in der Nähe von Druckbehältern ausführen.

- Keine Schweiß- oder Schneidarbeiten an geschlossenen Behältern oder Röhren durchführen. Beim Schweißen von Röhren oder Behältern besonders aufmerksam sein, auch wenn diese geöffnet, entleert und sorgfältig gereinigt wurden. Rückstände von Gas, Kraftstoff, Öl oder ähnlichen Substanzen können Explosionen verursachen.
- Nicht an Orten schweißen die explosive Staubteile, Gase oder Dämpfe enthalten.
- Nach dem Schweißen sicherstellen, dass der unter Spannung stehende Kreis nicht zufällig Teile berühren kann, die mit dem Massekreis verbunden sind.
- In der Nähe des Arbeitsbereichs Feuerlöschgerät platzieren.

1.5 Schutzmaßnahmen im Umgang mit Gasflaschen



Inertgasflaschen enthalten unter Druck stehendes Gas und können explodieren, wenn das Mindestmaß an Sicherheitsanforderungen für Transport, Lagerung und Gebrauch nicht gewährleistet ist.

- Die Gasflaschen müssen senkrecht an der Wand oder in anderen dafür vorgesehenen Vorrichtungen befestigt werden, damit sie nicht umfallen oder etwas anderes beschädigen können.
- Die Schutzkappe festschrauben, um das Ventil beim Transport, der Inbetriebnahme und nach Ende eines jeden Schweißvorgangs zu schützen.
- Die Flaschen weder direkter Sonneneinstrahlung noch hohen Temperaturschwankungen aussetzen. Die Flaschen dürfen keinen allzu niedrigen oder hohen Temperaturen ausgesetzt werden.
- Die Gasflaschen dürfen nicht mit offenem Feuer, elektrischen Lichtbögen, Brennern oder Schweißzangen und nicht mit beim Schweißen verspritzten glühenden Teilchen in Berührung kommen.
- Die Gasflaschen von Schweiß- und Stromkreisen im Allgemeinen fernhalten.
- Beim Öffnen des Ventils den Kopf fern von der Auslassöffnung des Gases halten.
- Das Ventil der Gasflasche immer schließen, wenn die Schweißarbeiten beendet sind.
- Niemals Schweißarbeiten an einer unter Druck stehenden Gasflasche ausführen.
- Eine Druckgasflasche darf nie direkt an den Druckminderer des Schweißgerätes angeschlossen werden! Der Druck kann die Kapazität des Druckminderers übersteigen, welcher deswegen explodieren könnte!

1.6 Schutz vor Elektrischem Schlag



Ein Stromschlag kann tödlich sein.

- Üblicherweise unter Spannung stehende Innen- oder Außenteile der gespeisten Schweißanlage nicht berühren (Brenner, Zangen, Massekabel, Elektroden, Draht, Rollen und Spulen sind elektrisch mit dem Schweißstromkreis verbunden).
- Die elektrische Isolierung der Anlage durch Benutzung trockener und ausreichend vom Erd- und Massepotential isolierter Flächen und Untergestelle sicherstellen.
- Sicherstellen, dass die Anlage an einer Steckdose und einem Stromnetz mit Schutzleiter korrekt angeschlossen wird.
- Achtung: Nie zwei Schweißbrenner oder zwei Schweißzangen gleichzeitig berühren.
- Die Schweißarbeiten sofort abbrechen, wenn das Gefühl eines elektrischen Schlags wahrgenommen wird.

1.7 Elektromagnetische Felder und Störungen



Der Strom, der durch die internen und externen Kabel der Anlage fließt, erzeugt in der unmittelbaren Nähe der Schweißkabel und der Anlage selbst ein elektromagnetisches Feld.

- Elektromagnetische Felder können die Gesundheit von Personen angreifen, die diesen langfristig ausgesetzt sind. (genaue Auswirkungen sind bis heute unbekannt).
- Elektromagnetische Felder können Störungen an Geräten wie Schrittmachern oder Hörgeräten verursachen.



Die Träger lebenswichtiger elektronischer Apparaturen (Schrittmacher) müssen die Genehmigung des Arztes einholen, bevor sie sich Verfahren wie Lichtbogenschweißen.

1.7.1 EMV in Übereinstimmung mit: EN 60974-10/A1:2015.

Klasse
B

Anlagen der Klasse B entsprechen den elektromagnetischen Kompatibilitätsanforderungen in Mischgebieten, einschließlich Wohngebieten, in denen die elektrische Leistung von dem öffentlichen Niederspannungsversorgungsnetz geliefert wird.

Klasse
A

Anlagen der Klasse A sind nicht für die Nutzung in Wohngebieten konzipiert, in denen die elektrische Leistung vom öffentlichen Niederspannungsversorgungsnetz geliefert wird. Es können potenzielle Schwierigkeiten beim Sicherstellen der elektromagnetischen Kompatibilität von Anlagen der Klasse A in diesen Umgebungen auftreten, aufgrund der ausgestrahlten Störgrößen.

Weitere Informationen finden Sie unter: LEISTUNGSSCHILDER oder TECHNISCHE DATEN.

1.7.2 Installation, Gebrauch und Bewertung des Bereichs

Dieses Gerät ist in Übereinstimmung mit den Angaben der harmonisierten Norm hergestellt EN 60974-10/A1:2015 und als Gerät der "KLASSE A" gekennzeichnet. Dieses Gerät darf nur für gewerbliche Zwecke im industriellen Umfeld angewendet werden. Der Hersteller haftet nicht für Schäden, die durch den Gebrauch der Anlage im Haushalt verursacht wurden.



Der Benutzer muss ein erfahrener Fachmann auf dem Gebiet sein und ist als solcher für die Installation und den Gebrauch des Geräts gemäß den Herstelleranweisungen verantwortlich. Wenn elektromagnetische Störungen festgestellt werden, muss der Benutzer des Gerätes das Problem lösen, wenn notwendig mit Hilfe des Kundendienstes des Herstellers.



In jedem Fall müssen die elektromagnetischen Störungen soweit reduziert werden, bis sie keine Belästigung mehr darstellen.



Bevor das Gerät installiert wird, muss der Benutzer die möglichen elektromagnetischen Probleme, die sich im umliegenden Bereich ergeben können, und insbesondere die Gesundheit, der sich in diesem Bereich aufhaltenden Personen - Träger von Schrittmachern und Hörgeräten - prüfen.

1.7.3 Vorsichtsmaßnahmen für die Kabel

Um die Auswirkungen der elektromagnetischen Felder so gering wie möglich zu halten, sind folgende Maßnahmen zu treffen:

- Masse- und Leistungskabel, wo möglich, zusammen verlegen und aneinander befestigen.
- Die Kabel nie um den Körper wickeln.
- Sich nicht zwischen Masse- und Leistungskabel stellen (beide Kabel auf derselben Seite halten).
- Die Kabel müssen so kurz wie möglich sein, so dicht wie möglich beieinander liegen und am bzw. in der Nähe des Bodens verlaufen.
- Die Anlage in einem gewissen Abstand vom Bereich aufstellen, in dem geschweißt wird.
- Die Kabel müssen fern von anderen vorhandenen Kabeln verlegt sein.

1.7.4 Potentialausgleich

Der Erdanschluss aller Metallteile in der Schweißanlage (Schneidanlage) und in der Nähe derselben muss berücksichtigt werden. Die Vorschriften bezüglich des Potentialausgleiches beachten.

1.7.5 Erdung des Werkstücks

Wenn das Werkstück aus Gründen der elektrischen Sicherheit oder aufgrund seiner Größe und Lage nicht geerdet ist, könnte ein Erdanschluss des Werkstücks die Emissionen reduzieren. Es muss dringend beachtet werden, dass eine Erdung des Werkstücks weder die Unfallgefahr für den Bediener erhöhen noch andere elektrische Geräte beschädigen darf. Die Erdung muss gemäß den örtlichen Vorschriften erfolgen.

1.7.6 Abschirmung

Durch die selektive Abschirmung anderer Kabel und Geräte im umliegenden Bereich lassen sich die Probleme durch elektromagnetische Störungen reduzieren.

Die Abschirmung der gesamten Schweißanlage kann in besonderen Fällen in Betracht gezogen werden.

1.8 Schutzart IP



IP23S

- Gehäuse mit Schutz gegen Berührung gefährlicher Teile mit den Fingern und vor dem Eindringen von Fremdkörpern mit einem Durchmesser größer/gleich 12,5 mm.
- Gehäuse mit Schutz gegen Sprühwasser bis zu einem Winkel von 60° in Bezug auf die Senkrechte.
- Gehäuse mit Schutz gegen Schäden durch eindringendes Wasser, wenn die beweglichen Teile der Anlage im Stillstand sind.

1.9 Entsorgung



Das Elektrogerät nicht in den normalen Hausmüll geben!

Gemäß der europäischen Richtlinie 2012/19/EU über Elektro- und Elektronik-Altgeräte und der Umsetzung dieser Richtlinie in innerstaatliches Recht müssen die Geräte am Ende ihrer Nutzungsdauer getrennt gesammelt und einer Verwertungs- und Recyclingstelle zugeführt werden. Der Eigentümer des Geräts muss die autorisierten Sammelstellen durch Kontaktnahme der örtlichen Behörden in Erfahrung bringen. Durch die Einhaltung der Europäischen Richtlinie schützen Sie die Umwelt und die Gesundheit Ihrer Mitmenschen.

» Weitere Infos finden Sie auf der Website.

2. INSTALLATION



Die Installation darf nur von erfahrenerm und vom Hersteller berechtigtem Personal ausgeführt werden.



Stellen Sie sicher, dass während der Installation der Generator vom Versorgungsnetz getrennt ist.

2.1 Heben, Transportieren und Abladen

- Die Anlage ist mit einem Griff zur Beförderung von Hand versehen.
- Die Anlage hat keine speziellen Hebevorrichtungen.
- Einen Gabelstapler einsetzen und dabei sehr vorsichtig sein, um ein Umkippen des Generators zu vermeiden.



Das Gewicht der Anlage ist nicht zu unterschätzen, siehe Technische Daten.
 Bewegen oder platzieren Sie die angehängte Last nicht über Personen oder Gegenständen.
 Lassen Sie das Gerät/die Anlage nicht fallen und üben Sie keinen übermäßigen Druck auf die Anlage aus.

2.2 Aufstellen der Anlage



Folgende Vorschriften beachten:

- Sorgen Sie für freien Zugang zu den Bedienelementen und Anschlüssen.
- Stellen Sie die Anlage nicht in engen Räumen auf.
- Stellen Sie die Anlage nie auf einer Fläche mit einer Neigung von mehr als 10° auf.
- Stellen Sie die Anlage an einem trockenen und sauberen Ort mit ausreichender Belüftung auf.
- Schützen Sie die Anlage vor strömenden Regen und Sonne.

2.3 Elektrischer Anschluss



Die beweglichen Einheiten werden ausschließlich mit Niederspannung gespeist.

2.4 Inbetriebnahme

2.4.1 Anschluss für MIG/MAG-Schweißen

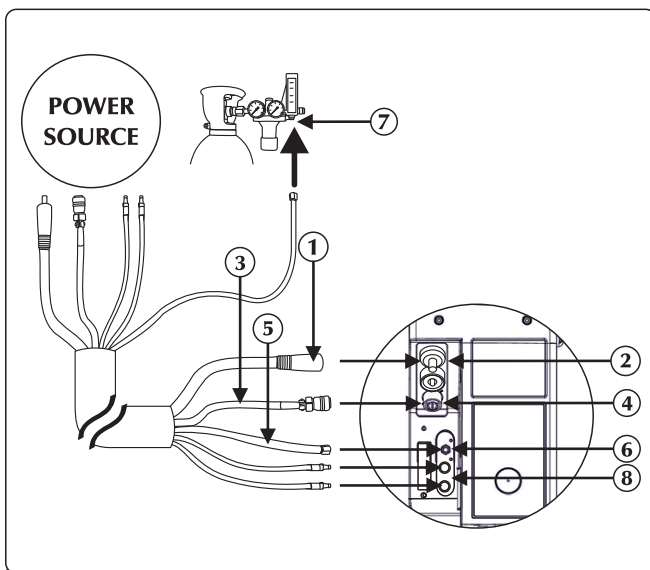

- ① Leistungskabel
- ② Positive Leistungsbuchse (+)
- ③ Signalkabel
- ④ Eingang Signalkabel
- ⑤ Brennergas
- ⑥ Gasanschluss
- ⑦ Gasversorgungsanschluss
- ⑧ Anschluss Kühlmittel

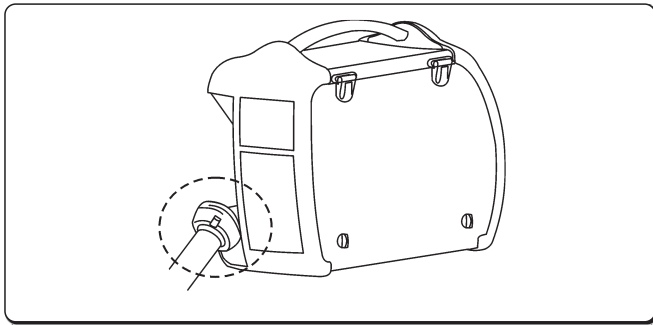

- ▶ Das Leistungskabel mit entsprechender Ausgangsbuchse verbinden. Den Stecker einstecken und im Uhrzeigersinn drehen, bis alle Teile fest sind.
- ▶ Das Signalkabel des Schlauchpaketes mit dem entsprechenden Anschluss verbinden. Den Stecker einstecken und die Schraubverriegelung im Uhrzeigersinn drehen, bis alle Teile ganz fest sind.
- ▶ Den Gasschlauch des Schlauchpaketes mit dem Druckminderer der Gasflasche oder dem Anschluss der Gaszuleitung verbinden. Den Gasdurchfluss auf einen Wert zwischen 10 und 30 l/min einstellen.
- ▶ Den blauen Schlauch des Schlauchpaketes mit dem entsprechenden Schnellverbinder für den Rücklauf der Kühlflüssigkeit (blau) verbinden.
- ▶ Den roten Schlauch des Schlauchpaketes mit dem entsprechenden Schnellverbinder für den Rücklauf der Kühlflüssigkeit (rot) verbinden.
- ▶ Das CAN-BUS-Signalkabel zur Steuerung externer Geräte (wie RC, RI...) mit dem entsprechenden Anschluss verbinden.

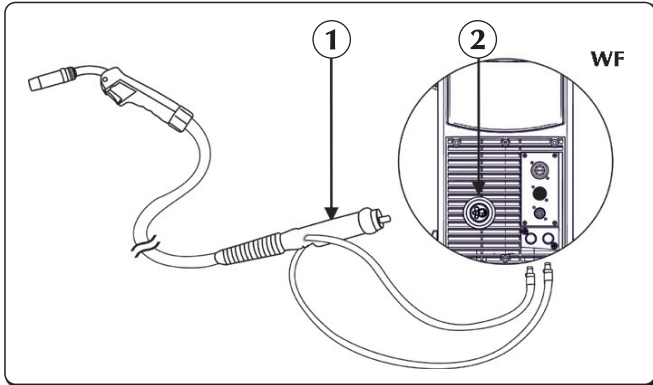

Siehe Abschnitt „Installation Zubehör“.



- ① Brenneranschluss
- ② Verbinder

- ▶ Den roten Schlauch (Rücklauf der Kühlflüssigkeit) des Brenners mit dem entsprechenden Schnellverbinder  (rot) verbinden.
- ▶ Den blauen Schlauch (Vorlauf der Kühlflüssigkeit) des Brenners mit dem entsprechenden Schnellverbinder  (blau) verbinden.
- ▶ Den MIG/MAG-Brenner mit dem Anschluss verbinden, dabei sicherstellen, dass die Schraubverriegelung fest angeschraubt ist.

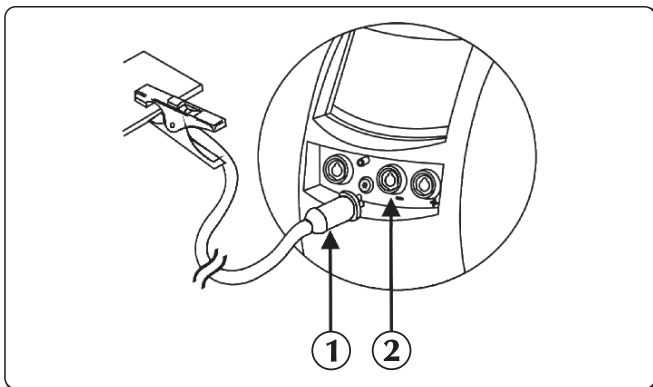

- ① Verbinder der Erdungsange
- ② Negative Leistungsbuchse (-)

- ▶ Den Verbinder der Erdungsange an die Steckdose des Minuskabels (-) des Generators anschließen. Den Stecker einstecken und im Uhrzeigersinn drehen, bis alle Teile fest sind.

Motorfach

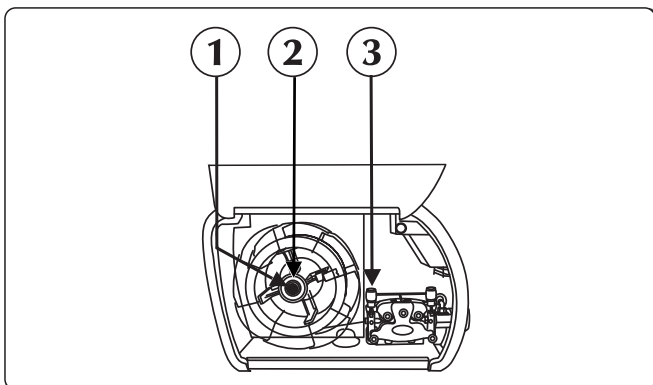

- ① Rändelmutter
- ② Spulenbremse
- ③ Andruckrollen des Drahtvorschubs

- ▶ Die rechte Klappe des Gehäuses öffnen.
- ▶ Kontrollieren, ob die Rille in der Rolle mit dem gewünschten Drahtdurchmesser übereinstimmt.
- ▶ Die Rändelmutter vom Spulendorn der Drahtspule abschrauben und die Spule einsetzen.
- ▶ Den Mitnehmerstift in seinen Sitz einrasten lassen, die Spule einsetzen, die Rändelmutter wieder aufschrauben und die Spulenbremse einstellen.
- ▶ Die Andruckrollen des Drahtvorschubs entriegeln und das Drahtende in die Drahtführungsbuchse stecken und über die Rolle in den Brenneranschluss führen. Die Andruckrollen verriegeln und kontrollieren, ob sich der Draht in der Rille der Rollen befindet.
- ▶ Auf die Drahtvorschubtaste drücken, damit der Draht in den Brenner befördert wird.
- ▶ Den Gasdurchfluss auf einen Wert zwischen 10 und 30 l/min einstellen.

3. PRÄSENTATION DER ANLAGE

3.1 Hintere Tafel

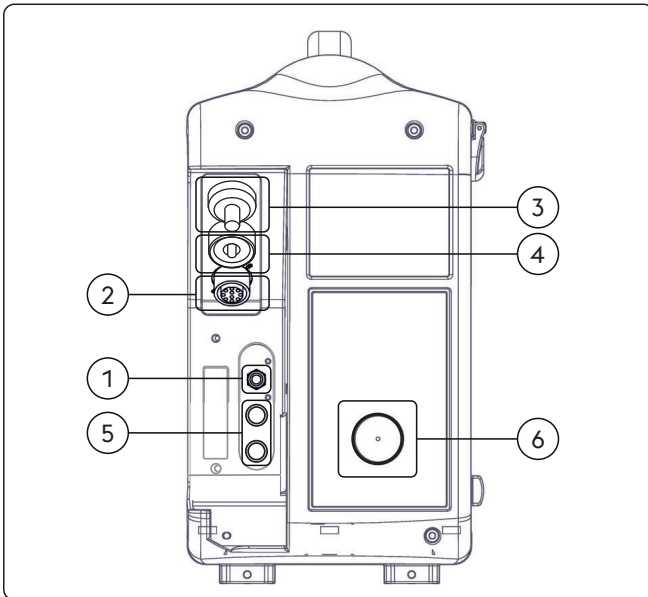

- ① Gasanschluss
- ② Signalkabeleingang (CAN-BUS) (Kabelstrang)
- ③ Leistungskabeleingang (Kabelstrang)
- ④ Positive Leistungsbuchse (+)
- ⑤ Vor- und Rücklauf Kühlmittel
- ⑥ Eingang Draht



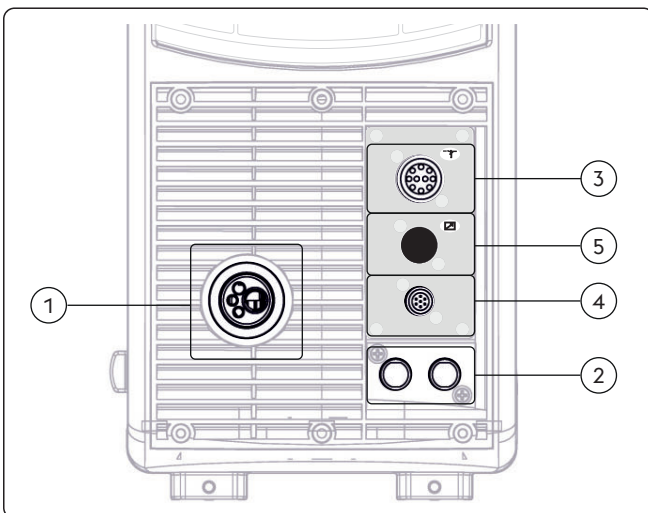



3.2 Buchsenfeld

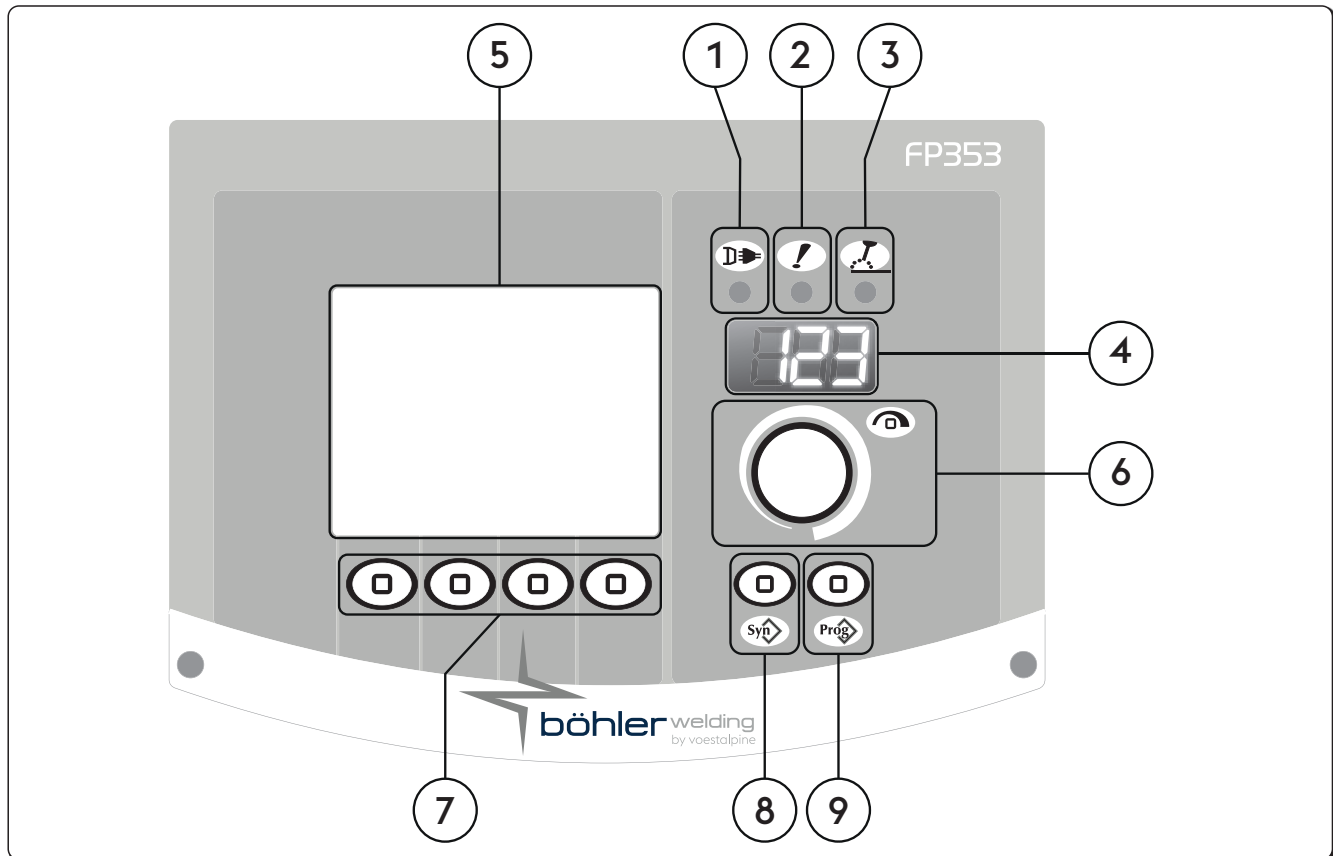

- ① Brenneranschluss
Für den Anschluss des MIG/MAG-Brenners.
- ② Anschluss Kühlmittel
- ③ Eingang Signalkabel (Push-Pull)
- ④ Signalkabeleingang (Schweißbrenner)
Brenneranschluss
- ⑤ Eingang Signalkabel (RC)

3.3 Frontbedienfeld



- ①  **LED Versorgung**
 Zeigt an, dass die Anlage an die Stromversorgung angeschlossen und eingeschaltet ist.
- ②  **LED Allgemeiner Alarm**
 Zeigt den möglichen Eingriff von Schutzeinrichtungen an, z. B. Temperaturschutz.
- ③  **LED Aktive Leistung**
 Zeigt an, dass an den Ausgangsklemmen der Anlage Spannung anliegt.
- ④  **7-Segment-Anzeige**
 Ermöglicht die Anzeige allgemeiner Geräteparameter während des Startens; Ablesen von Einstellungen, Strom und Spannung während des Schweißens und die Anzeige von Fehlercodes.
- ⑤  **LCD Display**
 Ermöglicht die Anzeige allgemeiner Geräteparameter während des Startens; Ablesen von Einstellungen, Strom und Spannung während des Schweißens und die Anzeige von Fehlercodes.
 Ermöglicht die verzögerungsfreie Anzeige aller Vorgänge.
- ⑥  **Hauptregler**
 Ermöglicht den Zugang zum Setup, die Auswahl und Einstellung der Schweißparameter.
- ⑦  **Funktionstasten**
 Ermöglicht die Auswahl der verschiedenen Funktionen der Anlage:
 - Schweißverfahren E-Hand
 - Schweißmethoden
 - Impulsstrom
 - Grafikmodus

8



Schweißprogrammen-Tasten

Ermöglicht die Auswahl eines voreingestellten Schweißprogramms über die Auswahl einiger einfacher Informationen:

- Drahttyp
- Art des Gases
- Drahtdurchmesser

9



Job-Taste

4. VERWENDUNG VON GERÄTEN

4.1 Startbildschirm

Wenn der Generator eingeschaltet wird, führt er eine Abfolge von Überprüfungen durch, um das korrekte Arbeiten der Anlage und aller angeschlossenen Geräte zu gewährleisten. An dieser Stelle wird auch der Gastest durchgeführt, um den richtigen Anschluss der Gaszufuhr zu prüfen.

4.2 Test-Anzeige

Wenn das Seitenpaneel (Spulenteil) geöffnet ist, sind Schweißarbeiten verboten. Die Test-Anzeige erscheint im LCD-Display.

⑤ → G3/4 Si1 1.0mm Ar 18%CO₂

④ →

③ → 3.0 $\frac{m}{min}$

① ②

① Test Kühlaggregat

② Gastest

③ Drahtvorschubgeschwindigkeit

④ Seitenpaneel offen

⑤ Kopfzeile



Test Kühlaggregat

Ermöglicht den manuellen Drahtvorschub ohne Gasdurchfluss und ohne dass Spannung am Draht anliegt. Ermöglicht die Einführung des Drahtes in die Drahtführungsspirale des Schweißbrenners in der Schweißvorbereitungsphase.



Gastest

Ermöglicht die Reinigung des Schutzgaskreises und die Durchführung der entsprechenden Einstellungen des Schutzgasdrucks und -durchflusses bei abgeschalteter Leistung.



Drahtvorschubgeschwindigkeit

Ermöglicht die Einstellung der Drahtvorschubgeschwindigkeit (Während der Ladephase).

Minimum	Maximal	Standard
0.5 m/min	22.0 m/min	3.0 m/min



Seitenpaneel offen



Kopfzeile

Ermöglicht die Anzeige bestimmter wichtiger Informationen in Bezug auf das gewählte Verfahren.

4.3 Haupt-Menü

Ermöglicht die Steuerung der Anlage und des Schweißverfahrens und zeigt die Haupteinstellungen an.

DE

4.4 Hauptbildschirmseite des MIG/MAG-Prozesses

Basisbildschirmseite

① Kopfzeile Mig/MAG
② Schweißparameter
③ Funktionen

Grafikbildschirmseite

① Kopfzeile Mig/MAG
② Schweißparameter
③ Funktionen

Kopfzeile Mig/MAG

Ermöglicht die Anzeige bestimmter wichtiger Informationen in Bezug auf das gewählte Verfahren.

Gewählte Synergiekurve

- ① Art des Zusatzmaterials
- ② Drahtdurchmesser
- ③ Art des Gases

Schweißparameter

- ① Schweißstrom
- ② Werkstückdicke
- ③ Kehlnaht "a"
- ④ Schweißspannung

Schweißparameter (Basisbildschirmseite)

► Wählen Sie den gewünschten Parameter aus, indem Sie den Taster Encoder drücken.

- ① Schweißparameter
- ② Symbol des Parameters
- ③ Wert des Parameters
- ④ Maßeinheit des Parameters

Schweißparameter (Grafikbildschirmseite)

► Wählen Sie den gewünschten Parameter aus, indem Sie den Taster Encoder drücken.

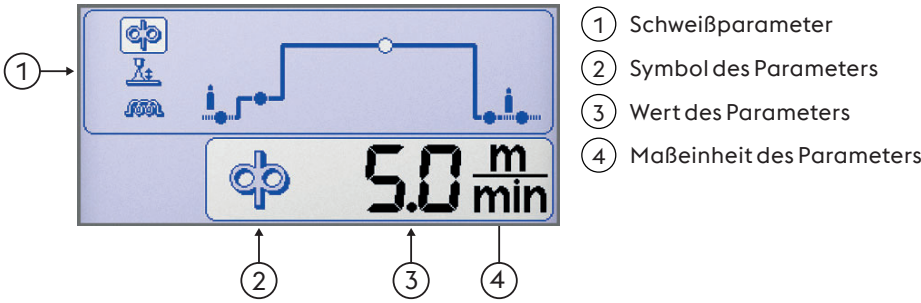

Funktionen

Ermöglicht das Einstellen der wichtigsten Funktionen des Schweißverfahrens und der Schweißmethoden.

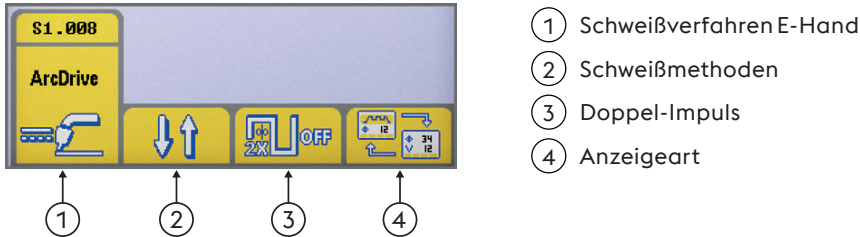

Schweißmethoden

Ermöglicht die Auswahl der Schweißmethode

- 

2-Taktbetrieb, in zwei Stufen
 Drücken des Tasters startet den Gasdurchfluss, speist den Draht mit Spannung und startet den Drahtvorschub;
 beim Loslassen des Tasters werden Gas, Spannung und Drahtvorschub abgestellt.
- 

4-Taktbetrieb, in vier Stufen
 Das erste Drücken des Tasters startet den Gasdurchfluss mit manueller Gasvorströmzeit. Loslassen des Tasters legt Spannung an den Draht und startet den Vorschub. Das erneute Drücken des Tasters stoppt den Drahtvorschub und setzt den Strom zurück auf Null. Abschließendes Loslassen des Tasters beendet den Gasdurchfluss.
- 

Hotstart und Endkraterstrom
 Ermöglicht Schweißen in drei verschiedenen Leistungsstufen, die direkt vom Schweißer gewählt und gesteuert werden können, indem er den Brennergastaster betätigt.
 Das erste Drücken des Tasters startet den Gasdurchfluss, legt Spannung an den Draht und startet den Vorschub mit der Geschwindigkeit, die im Parameter „Drahteinschleichen“ (während des Setup) eingestellt und mit den relativen Synergie-Werten der Schweißparameter festgelegt wurde.
 Wenn der Brennergastaster losgelassen wird, ändern sich die Werte für die Drahtvorschubgeschwindigkeit und die relativen synergischen Parameter automatisch in die Grundwerte, die am Bedienfeld eingestellt sind.
 Das erneute Drücken des Brennergastasters bringt die Werte der Drahtgeschwindigkeit und der relativen synergischen Parameter auf die während des Setups voreingestellten Werte der Parameter des Endkraterfüllers.
 Loslassen des Brennergastasters stoppt den Drahtvorschub und liefert die Leistung für die Drahrückbrand- und Gasnachströmphase.



Doppel-Impuls

- 

Doppel-Impuls aktiviert
- 

Doppel-Impuls nicht aktiviert

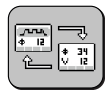

Anzeigart

- Ermöglicht den Wechsel der Anzeige zwischen:
- 

Basisbildschirmseite
 - 

Grafikbildschirmseite

Synergiekurven-Menü



Synergie

Ermöglicht die Auswahl eines voreingestellten Schweißprogramms (Synergie) über die Auswahl einiger einfacher Informationen

Wahl des Schweißprozesses

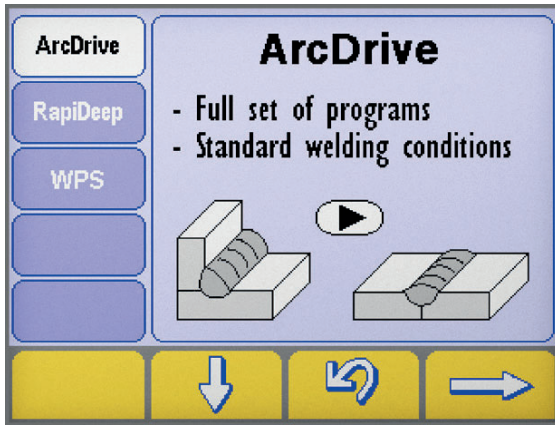

- ▶ Die Bildschirmseite „Synergien“ durch Drücken der Taste für mindestens eine Sekunde aufrufen.
- ▶ Den gewünschten Schweißprozess mit den Tasten wählen und .
- ▶ Drücken Sie die Taste um zum nächsten Schritt zu gelangen.

DE



Wahlbildschirmseite der Synergie Materialtyp/Gasart

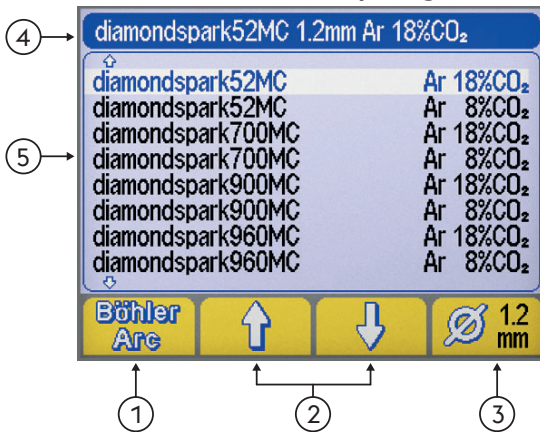

- 1 Schweißprogramm (BöhlerArc/UniversalArc)
- 2 Material-/Gaswahl
- 3 Drahtdurchmesser
- 4 Kopfzeile
- 5 Schweißprogramm



Schweißprogramm

Ermöglicht die Auswahl der Schweißprogramm



BöhlerArc



UniversalArc



Material-/Gaswahl

Ermöglicht die Auswahl von:



- Art des Zusatzmaterials
- Art des Gases



Drahtdurchmesser

Ermöglicht die Wahl des verwendeten Drahtdurchmessers (mm).

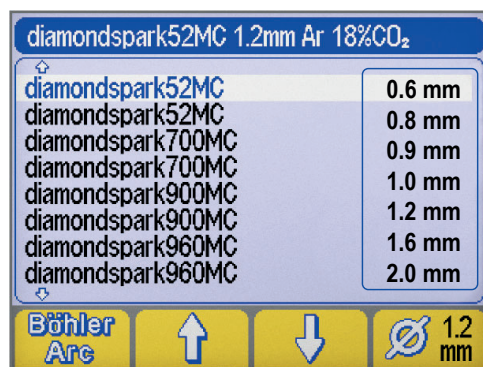

- 1 Drahtdurchmesser





Kopfzeile

Ermöglicht die Anzeige bestimmter wichtiger Informationen in Bezug auf das gewählte Verfahren.



NO PROGRAM

Zeigt an, dass die gewählte Synergiekurve nicht verfügbar oder mit den anderen Einstellungen der Anlage nicht vereinbar ist.

5. SETUP

5.1 Setup und Parametereinstellung

Ermöglicht die Einstellung und Regelung einer Reihe Zusatzparameter, um die Schweißanlage besser und präziser betreiben zu können.

Die im Setup vorhandenen Parameter sind nach dem gewählten Schweißprozess geordnet und haben eine Nummerncodierung.

Zugriff auf Setup



- ▶ Erfolgt durch 5 Sekunden langes Drücken der Encoder-Taste.
- ▶ Der Zugriff wird durch den Eintrag 0 am Display bestätigt.

Auswahl und Einstellung des gewünschten Parameters

- ▶ Erfolgt durch Drehen des Encoders bis zur Anzeige des Nummerncodes des gewünschten Parameters.
- ▶ Durch Drücken der Taste Encoder wird nun der für den gewählten Parameter eingestellte Wert sichtbar und kann reguliert werden.

Verlassen des Setup

- ▶ Um den Abschnitt „Einstellungen“ zu verlassen, erneut auf die Taste Encoder drücken.
- ▶ Um das Setup zu verlassen, auf Parameter "0" (Speichern und Beenden) gehen und erneut auf die Taste Encoder drücken.
- ▶ Brechen Sie den Vorgang ab, indem Sie die Taste drücken .
- ▶ Zum Speichern der Änderungen und Verlassen des Setups folgende Taste drücken: .

5.1.1 Liste der Setup-Parameter (E-Hand-Schweißen)

0

Speichern und Beenden

Für das Speichern der Änderungen und Verlassen des Setup.



1

Reset

Für die Rücksetzung aller Parameter auf die Standardwerte.



3

Hot start

Für die Einstellung des Hot-Start-Wertes beim E-Hand-Schweißen.

Ermöglicht einen verstellbaren Hot-Start-Wert der Zündphasen des Bogens und erleichtert die Startvorgänge.



Basischelektroden

Minimum	Maximal	Standard
0/aus	500%	80%

Zellulose elektroden

Minimum	Maximal	Standard
0/aus	500%	150%

CrNi-elektroden

Minimum	Maximal	Standard
0/aus	500%	100%

Aluminiumelektrode

Minimum	Maximal	Standard
0/aus	500%	120%

Gusseisenelektrode

Minimum	Maximal	Standard
0/aus	500%	100%

7

Schweißstrom

Ermöglicht die Einstellung des Schweißstroms.



Minimum	Maximal	Standard
3 A	Imax	100 A

8

Arc force

Für die Einstellung des Arc-Force-Wertes beim E-Hand-Schweißen.

Ermöglicht die Dynamikkorrektur des Bogens (plus oder minus) während des Schweißens. Dadurch wird die Arbeit des Schweißers erleichtert.

Ein Anheben des Wertes der Bogenstärke verringert das Risiko des Festklebens der Elektrode.



Basisch elektroden

Minimum	Maximal	Standard
0/aus	500%	30%

Zellulose elektroden

Minimum	Maximal	Standard
0/aus	500%	350%

CrNi-elektroden

Minimum	Maximal	Standard
0/aus	500%	30%

Aluminiumelektrode

Minimum	Maximal	Standard
0/aus	500%	100%

Gusseisenelektrode

Minimum	Maximal	Standard
0/aus	500%	70%

204

Dynamic power control (DPC)

Ermöglicht, die gewünschte U/I - Charakteristik auszuwählen.



I=C Konstanter Strom

Die Vergrößerung oder Reduzierung der Bogenhöhe hat keine Auswirkung auf den erforderlichen Schweißstrom.

Empfohlen für Elektrode: Basisch, Rutil, Sauer hohe, Stahl, Guss

1:20 Reduzierungscharakteristik mit Rampenregelung

Das Ansteigen der Bogenhöhe verursacht eine Reduzierung des Schweißstroms (und umgekehrt) entsprechend dem festen Wert von 1/20 Ampere pro Volt.

Empfohlen für Elektrode: Cellulose, Aluminium

P=C Konstante Leistung

Das Ansteigen der Bogenhöhe verursacht eine Reduzierung des Schweißstroms (und umgekehrt) entsprechend der Regel: $V \cdot I = K$

Empfohlen für Elektrode: Cellulose, Aluminium

312

Bogenabtrennungsspannung

Zur Einstellung des Spannungswertes, bei dem das Abtrennen des Schweißbogens erzwungen werden soll.

Verbessert den Umgang mit verschiedenen auftretenden Betriebsbedingungen.

Beim Punktschweißen zum Beispiel reduziert eine niedrige Bogenabtrennungsspannung die erneute Zündung des Bogens beim Entfernen der Elektrode vom Werkstück, vermindert Spritzer, Verbrennungen und Oxidation des Werkstücks.

Wenn Elektroden benutzt werden, die hohe Spannungen erfordern, sollte dagegen ein hoher Grenzwert eingestellt werden, um Bogenabtrennungen beim Schweißen zu verhindern.



Niemals eine Bogenabtrennungsspannung einstellen, die größer als die Leerlaufspannung des Generators ist.

Basisch elektroden

Minimum	Maximal	Standard
0/aus	99.9 V	57.0 V

Zellulose elektroden

Minimum	Maximal	Standard
0/aus	99.9 V	70.0 V

399

Schweißgeschwindigkeit

Ermöglicht die Einstellung der Ausführungsgeschwindigkeit der Schweißarbeit.

Default cm/min: Bezugsgeschwindigkeit für manuelles Schweißen.

Syn: Sinergic Wert.



Minimum	Maximal	Standard
1 cm/min	200 cm/min	15 cm/min

500 Maschineneinstellung

Ermöglicht die Auswahl der erforderlichen Grafikschnittstelle.
Ermöglicht den Zugang zu höheren Setup Levels.
Siehe Abschnitt "Interface-Personalisierung (Set up 500)"

Wert	Benutzeroberfläche	Wert	Ausgewählte Ebene
XE	Modus Easy	USER	Bediener
XA	Modus Advanced	SERV	Bedienung
XP	Modus Professional	vaBW	vaBW

551 Lock/unlock

Ermöglicht das Sperren der Bedienfelder und die Einführung eines Schutzcodes.
Siehe Abschnitt "Lock/unlock (Set up 551)".

552 Lautstärke der akustischen Warnvorrichtung

Zur Einstellung der Lautstärke der akustischen Warnvorrichtung.

Minimum	Maximal	Standard
0/aus	10	10

601 Schrittweite

Ermöglicht die Regulierung eines Parameters mit einer Schrittweite, die vom Bediener persönlich eingestellt werden kann.

Minimum	Maximal	Standard
1	Imax	1

602 Externer Parameter CH1, CH2, CH3, CH4

Ermöglicht das Verwalten externer Parameter 1, 2, 3, 4 (Minimalwert, Maximalwert, Standardwert, gewählter Parameter).
Siehe Abschnitt "Verwaltung Externer Steuerungen (Set up 602)".

705 Kalibrierung des Schweißkreiswiderstands

Ermöglicht die Einstellung der Anlage.
Siehe Abschnitt "Kalibrierung des Schweißkreiswiderstands (set up 705)".

751 Stromanzeige

Ermöglicht die Anzeige des Ist-Schweißstroms.

752 Spannungsanzeige

Ermöglicht die Anzeige der Ist-Schweißspannung.

768 Messung Wärmeeintrag HI

Ermöglicht das Ablesen des Wertes der Messung des Wärmeeintrags beim Schweißen.

801 Schutzgrenzen

Ermöglicht die Einstellung der Warn- und Schutzgrenzen.
Ermöglicht die Steuerung des Schweißverfahrens, indem Warn- und Schutzgrenzen für die messbaren Hauptparameter eingestellt werden.
Ermöglicht die genaue Steuerung der verschiedenen Schweißphasen.
Siehe Abschnitt "Schutzgrenzen (Set up 801)".

5.1.2 Liste der Setup-Parameter (WIG-Schweißen)
0 Speichern und Beenden

Für das Speichern der Änderungen und Verlassen des Setup.

1 Reset



Für die Rücksetzung aller Parameter auf die Standardwerte.

7

Schweißstrom



Ermöglicht die Einstellung des Schweißstroms.

Minimum	Maximal	Standard
3 A	I _{max}	100 A

399

Schweißgeschwindigkeit



Ermöglicht die Einstellung der Ausführungsgeschwindigkeit der Schweißarbeit.

Default cm/min: Bezugsgeschwindigkeit für manuelles Schweißen.

Syn: Sinergic Wert.

Minimum	Maximal	Standard
1 cm/min	200 cm/min	10 cm/min

500

Maschineneinstellung



Ermöglicht die Auswahl der erforderlichen Grafikschnittstelle.

Ermöglicht den Zugang zu höheren Setup Levels.

Siehe Abschnitt "Interface - Personalisierung (Set up 500)"

Wert	Benutzeroberfläche
XE	Modus Easy
XA	Modus Advanced
XP	Modus Professional

Wert	Ausgewählte Ebene
USER	Bediener
SERV	Bedienung
vaBW	vaBW

551

Lock/unlock



Ermöglicht das Sperren der Bedienfelder und die Einführung eines Schutzcodes.

Siehe Abschnitt "Lock/unlock (Set up 551)".

552

Lautstärke der akustischen Warnvorrichtung



Zur Einstellung der Lautstärke der akustischen Warnvorrichtung.

Minimum	Maximal	Standard
0/aus	10	10

601

Schrittweite



Ermöglicht die Regulierung eines Parameters mit einer Schrittweite, die vom Bediener persönlich eingestellt werden kann.

Minimum	Maximal	Standard
1	I _{max}	1

602

Externer Parameter CH1, CH2, CH3, CH4



Ermöglicht das Verwalten externer Parameter 1, 2, 3, 4 (Minimalwert, Maximalwert, Standardwert, gewählter Parameter).

Siehe Abschnitt "Verwaltung Externer Steuerungen (Set up 602)".

705

Kalibrierung des Schweißkreiswiderstands



Ermöglicht die Einstellung der Anlage.

Siehe Abschnitt "Kalibrierung des Schweißkreiswiderstands (set up 705)".

751

Stromanzeige



Ermöglicht die Anzeige des Ist-Schweißstroms.

752

Spannungsanzeige



Ermöglicht die Anzeige der Ist-Schweißspannung.

758 **Geschwindigkeit der Roboterbewegung**
 Ermöglicht die Anzeige der Geschwindigkeit des Roboterarms oder der automatischen Anlage.



768 **Messung Wärmeeintrag HI**
 Ermöglicht das Ablesen des Wertes der Messung des Wärmeeintrags beim Schweißen.



801 **Schutzgrenzen**
 Ermöglicht die Einstellung der Warn- und Schutzgrenzen.
 Ermöglicht die Steuerung des Schweißverfahrens, indem Warn- und Schutzgrenzen für die messbaren Hauptparameter eingestellt werden.
 Ermöglicht die genaue Steuerung der verschiedenen Schweißphasen.
 Siehe Abschnitt "Schutzgrenzen (Set up 801)".







5.1.3 Liste der Setup-Parameter (MIG/MAG-Schweißen)

0 **Speichern und Beenden**
 Für das Speichern der Änderungen und Verlassen des Setup.



1 **Reset**
 Für die Rücksetzung aller Parameter auf die Standardwerte.



2 **Schweißprogramme**
MIG/MAG-Standard-Schweißen:
 Ermöglicht die Wahl zwischen manuellem ( Off) MIG- oder synergischem ( **6**) MIG-Prozess, indem das zu schweißende Material eingestellt wird.
MIG/MAG- Impuls-Schweißen:
 Ermöglicht die Wahl synergischem ( **6**) MIG-Prozess, indem das zu schweißende Material eingestellt wird.
 Ermöglicht die Wahl CC/CV-Prozess.



3 **Drahtvorschubgeschwindigkeit**
 Ermöglicht die Einstellung der Drahtvorschubgeschwindigkeit.



Minimum	Maximal	Standard
0.5 m/min	22.0 m/min	-

4 **Strom**
 Ermöglicht die Einstellung des Schweißstroms.



Minimum	Maximal
3 A	I _{max}

5 **Werkstückdicke**
 Ermöglicht die Einstellung der Materialdicke des Werkstückes.
 Ermöglicht die Einstellung der Anlage durch die die Einstellung des Werkstückes.



6 **Kehlnaht "a"**
 Ermöglicht die Einstellung der Tiefe der Naht in einer Winkelverbindung.



10 **Gasvorströmen**
 Für die Einstellung und Regelung des Gasflusses vor der Bogenzündung.
 Für das Laden des Gases in den Brenner und die Vorbereitung der Umgebung auf das Schweißen.



Minimum	Maximal	Standard
0/aus	99.9 s	0.1 s



11 Soft start

Zur Einstellung der Drahtvorschubgeschwindigkeit in den Phasen, die der Zündung des Lichtbogens vorausgehen. Ermöglicht eine Zündung bei reduzierter Geschwindigkeit, die daher weicher und mit weniger Spritzern erfolgt.

Minimum	Maximal	Standard
10 %	100 %	50 %



12 Motorrampe

Für die Einstellung eines allmählichen Übergangs von der Drahtgeschwindigkeit bei der Zündung auf jene beim Schweißen.

Minimum	Maximal	Standard
0/aus	1.0 s	0/aus

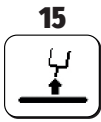

15 Burn back

Für die Regelung der Drahrückbrennzeit und zur Verhinderung des Anklebens bei Schweißende. Ermöglicht die Einstellung der Länge des Drahtendes außerhalb des Brenners.

Minimum	Maximal	Standard
-2.00	+2.00	0/syn



16 Gasnachströmen

Für die Einstellung des Gasflusses bei Schweißende.

Minimum	Maximal	Standard
0/aus	99.9 s	2.0 s

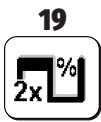

19 Duty cycle (Doppelimpuls)

Ermöglicht die Einstellung der Einschaltdauer beim Doppelimpuls-Schweißen.

Minimum	Maximal	Standard
10 %	90 %	50 %



20 Doppel-Impuls

Ermöglicht die Einstellung der Impulsamplitude.

Minimum	Maximal	Standard
0 %	100 %	±25 %
Minimum	Maximal	Standard
0.5 m/min	22 m/min	2.5 m/min

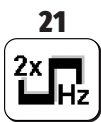
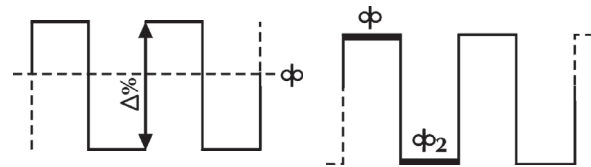

21 Impulszeit (Doppelimpuls)

Ermöglicht die Einstellung des Zyklus, z. B. des Impulswiederholungszyklus. Ermöglicht die Regulierung der Impulsfrequenz.

Minimum	Maximal	Standard
0.1 Hz	5.0 Hz	2.0 Hz

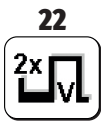

22 Sekundärspannung (Doppelimpuls)

Ermöglicht die Einstellung der Höhe der Impuls-Sekundärspannung. Ermöglicht das Erreichen einer größeren Bogenstabilität während der verschiedenen Impulsphasen.

Minimum	Maximal	Standard
-5.0	+5.0	0/syn



23 Impulssteilheit (Doppelimpuls)

Ermöglicht die Einstellung einer Rampen-Zeit während des Impulsbetriebs.

Minimum	Maximal	Standard
1 %	100 %	50 %

24 Bilevel (4T - crater filler)

Für die Einstellung des Sekundärdrahtgeschwindigkeit in der Schweißmethode Bilevel.

Wenn der Schweißer den Knopf drückt und ihn schnell losläßt, geht man zum zweiten Schweißstrom " ϕ_2 " über.

Drücken und schnelles Loslassen des Knopfes geht man wieder auf " ϕ " usw. über.

Minimum	Maximal	Standard
1 %	200 %	0/aus

25 Drahteinschleichen

Ermöglicht die Einstellung des Wertes der Drahtgeschwindigkeit während der Anfangs- Krater-Phase.

Ermöglicht das Ansteigen der dem Werkstück zugeführten Energie während der Phase, in der das Material (noch kalt) mehr Wärme benötigt, um gleichmäßig zu schmelzen.

Minimum	Maximal	Standard
20 %	200 %	120 %

26 Hotstart und Endkraterstrom

Ermöglicht die Einstellung des Wertes der Drahtgeschwindigkeit während der Endkrater-Phase.

Ermöglicht das Absinken der dem Werkstück zugeführten Energie während der Phase, in der das Material bereits sehr heiß ist. So wird das Risiko von ungewollten Deformationen verringert.

Minimum	Maximal	Standard
20 %	200 %	80 %

27 Takten der Anfangsanstiegs

Ermöglicht die Einstellung der Zeit des Anfangsanstiegs.

Ermöglicht die Automatisierung der Funktion "Endkraterfüller".

Minimum	Maximal	Standard
0.1 s	99.9 s	0/aus

28 Takten des Endkraterfüllers

Ermöglicht die Einstellung der Zeit des "Endkraterfüllers".

Ermöglicht die Automatisierung der Funktion "Endkraterfüller".

Minimum	Maximal	Standard
0.1 s	99.9 s	0/aus

30 Punktschweißen

Für die Aktivierung des Punktschweißens und die Festlegung der Schweißzeit.

Minimum	Maximal	Standard
0.1 s	99.9 s	0/aus

31 Pausenzeit

Für die Aktivierung und das Festlegen der Pausenzeit zwischen einem Schweißvorgang und dem nächsten.

Minimum	Maximal	Standard
0.1 s	99.9 s	0/aus

32 Sekundärspannung (MIG-Bilevel)

Ermöglicht die Einstellung der Höhe der Impuls-Sekundärspannung.

Ermöglicht das Erreichen einer größeren Bogenstabilität während der verschiedenen Impulsphasen.

Minimum	Maximal	Standard
-5.0	+5.0	0/syn

33 Sekundärinduktivität (MIG-Bilevel)

Ermöglicht die Einstellung der Höhe der Impuls-Sekundärinduktivität.

Ermöglicht das Erreichen eines schnelleren oder langsameren Bogens, um die Bewegung des Schweißers und die natürliche Schweißinstabilität zu kompensieren.

Niedrige Induktivität = reaktionsfähiger Bogen (mehr Spritzer).

Hohe Induktivität = reaktionsträger Bogen (weniger Spritzer).

Minimum	Maximal	Standard
-30	+30	0/syn

DE



34 Drahteinschleichrampe

Für die Eingabe eines stufenweisen Übergangs vom Drahteinschleichen auf das Schweißen.

Minimum	Maximal	Standard
0 s	10 s	0/aus



35 Endkraterfüller-Rampe

Für die Eingabe eines stufenweisen Übergangs zwischen Schweißen und Endkraterfüller.

Minimum	Maximal	Standard
0 s	10 s	0/aus



202 Induktivität

Ermöglicht die elektronische Einstellung der dem Schweißkreis in Reihe geschalteten Induktivität.

Ermöglicht das Erreichen eines schnelleren oder langsameren Bogens, um die Bewegung des Schweißers und die natürliche Schweißinstabilität zu kompensieren.

Niedrige Induktivität = reaktionsfähiger Bogen (mehr Spritzer).

Hohe Induktivität = reaktionsträger Bogen (weniger Spritzer).

Minimum	Maximal	Standard
-30	+30	0/syn



331 Kompensierte durchschnittliche Spannung

Ermöglicht die Einstellung der Schweißspannung.



398 Bezugskonstante Verstellgeschwindigkeit

Bezugskonstante für alle Schweißprozesse

Verstellgeschwindigkeit des Schweißbrenners, auf die sich das System für die Berechnung der Schweißparameter bezieht



399 Schweißgeschwindigkeit

Ermöglicht die Einstellung der Ausführungsgeschwindigkeit der Schweißarbeit.

Default cm/min: Bezugsgeschwindigkeit für manuelles Schweißen.

Syn: Sinergic Wert.

Minimum	Maximal	Standard
syn min	syn max	35 cm/min



500 Maschineneinstellung

Ermöglicht die Auswahl der erforderlichen Grafikschnittstelle.

Ermöglicht den Zugang zu höheren Setup Levels.

Siehe Abschnitt "Interface-Personalisierung (Set up 500)"

Wert	Benutzeroberfläche
XE	Modus Easy
XA	Modus Advanced
XP	Modus Professional

Wert	Ausgewählte Ebene
USER	Bediener
SERV	Bedienung
vaBW	vaBW



551 Lock/unlock

Ermöglicht das Sperren der Bedienfelder und die Einführung eines Schutzcodes.

Siehe Abschnitt "Lock/unlock (Set up 551)".



552 Lautstärke der akustischen Warnvorrichtung

Zur Einstellung der Lautstärke der akustischen Warnvorrichtung.

Minimum	Maximal	Standard
0/aus	10	10

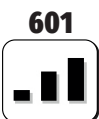

601 Schrittweite

Ermöglicht die Regulierung eines Parameters mit einer Schrittweite, die vom Bediener persönlich eingestellt werden kann.

Funktion über Taste Up/Down des Brenners steuerbar.

Minimum	Maximal	Standard
1	lmax	1

602 Externer Parameter CH1, CH2, CH3, CH4

Ermöglicht das Verwalten externer Parameter 1, 2, 3, 4 (Minimalwert, Maximalwert, Standardwert, gewählter Parameter).

Siehe Abschnitt "Verwaltung Externer Steuerungen (Set up 602)".

606 U/D Brenner

Ermöglicht das Verwalten externer Parameter (U/D).

Wert	Standard	Rückruffunktion
0/aus	-	aus
1/I1	X	Strom
	-	Programmabruf

612 DgMig Brennereinstellung

Ermöglicht die Steuerung der Kanäle des digitalen Schweißbrenners.

Wert	Standard	Rückruffunktion
0/aus	-	aus
1/I1	-	Strom
2/ 	-	Programmabruf
3/CH3	-	CH3
4/CH4	-	CH4
5/STD	X	STD

653 Drahtvorschubgeschwindigkeit

Ermöglicht die Einstellung der Drahtvorschubgeschwindigkeit (Während der Ladephase).

Minimum	Maximal	Standard
0.5 m/min	22.0 m/min	3.0 m/min

705 Kalibrierung des Schweißkreiswiderstands

Ermöglicht die Einstellung der Anlage.

Siehe Abschnitt "Kalibrierung des Schweißkreiswiderstands (set up 705)".

751 Stromanzeige

Ermöglicht die Anzeige des Ist-Schweißstroms.

752 Spannungsanzeige

Ermöglicht die Anzeige der Ist-Schweißspannung.

755 Gasdurchfluss-Anzeige

Ermöglicht die Anzeige des Gasdurchfluss-Istwertes.

757 Anzeige der Drahtgeschwindigkeit

Encoder-Anzeige Motor 1.

758 Geschwindigkeit der Roboterbewegung

Ermöglicht die Anzeige der Geschwindigkeit des Roboterarms oder der automatischen Anlage.

760 Stromanzeige (Motor 1)

Ermöglicht die Anzeige des Ist-Motorstroms (Motor 1).

768

Messung Wärmeeintrag HI

Ermöglicht das Ablesen des Wertes der Messung des Wärmeeintrags beim Schweißen.



770

Wert der Abschmelzleistung

Ermöglicht die Wertanzeige der Abschmelzleistung.



801

Schutzgrenzen

Ermöglicht die Einstellung der Warn- und Schutzgrenzen.

Ermöglicht die Steuerung des Schweißverfahrens, indem Warn- und Schutzgrenzen für die messbaren Hauptparameter eingestellt werden.

Ermöglicht die genaue Steuerung der verschiedenen Schweißphasen.

Siehe Abschnitt "Schutzgrenzen (Set up 801)".



DE

5.2 Spezielle Verfahren zur Verwendung der Parameter

5.2.1 Personalisierung der 7-Segment-Anzeige

Ermöglicht die konstante Anzeige eines Parameterwerts auf dem Display mit 7 Segmenten.

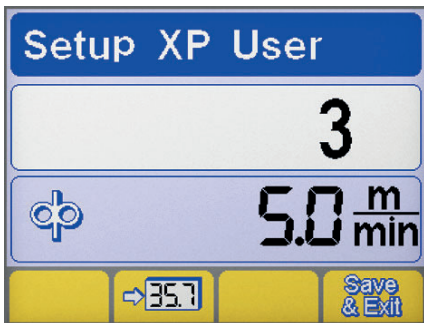

- ▶ Gehen Sie ins Set-up hinein, indem Sie den Taster Encoder für mindestens 5 Sekunden drücken.
- ▶ Wählen Sie den gewünschten Parameter, indem Sie den Encoder drehen.
- ▶ Speichern Sie den gewählten Parameter in der 7-Segment-Anzeige, indem Sie die Taste drücken .
- ▶ Speichern und verlassen Sie das aktuelle Menü, indem Sie die Taste drücken .

5.2.2 Interface-Personalisierung (Set up 500)

Ermöglicht das Anpassen der Parameter im Haupt-Menü.

500

Maschineneinstellung

Ermöglicht die Auswahl der erforderlichen Grafikschnittstelle.



Wert	Benutzeroberfläche
XE	Modus Easy
XA	Modus Advanced
XP	Modus Professional

MODUS XE

MIG/MAG

Schweißparameter

Funktionen

MODUS XA

MIG/MAG

Schweißparameter

Funktionen

MODUS XP

MIG/MAG

Schweißparameter	
Funktionen	

5.2.3 Lock/unlock (Set up 551)

Ermöglicht das Sperren der Bedienfelder und die Einführung eines Schutzcodes.

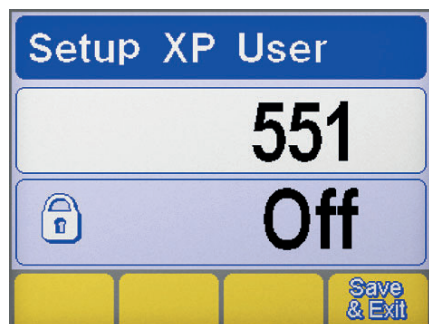

Parameterauswahl

- ▶ Gehen Sie ins Set-up hinein, indem Sie den Taster Encoder für mindestens 5 Sekunden drücken.
- ▶ Wählen Sie den gewünschten Parameter aus (551).
- ▶ Aktivieren Sie die Einstellung des gewählten Parameters, indem Sie den Taster Encoder drücken.

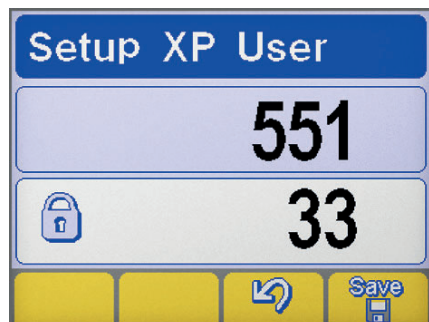

Passworteinstellung

- ▶ Stellen Sie einen Nummerncode (Passwort) ein, indem Sie den Encoder drehen.
- ▶ Den Vorgang durch Drücken der Encoder-Taste bestätigen.
- ▶ Brechen Sie den Vorgang ab, indem Sie die Taste drücken .
- ▶ Zum Speichern der Änderungen folgende Taste drücken: .

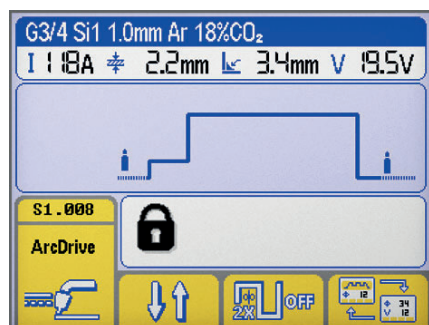

Bedienfeld-Funktionen

- ▶ Entsperren Sie das Bedienfeld zeitweise (für 5 Minuten), indem Sie den Encoder drehen und das richtige Passwort eingeben.
- ▶ Den Vorgang durch Drücken der Encoder-Taste bestätigen.
- ▶ Entsperren Sie das Bedienfeld dauerhaft, indem Sie ins Set-up hineingehen (Befolgen Sie die oben gemachten Anweisungen!) und setzen Sie den Parameter 551 zurück auf "OFF".
- ▶ Den Vorgang durch Drücken der Encoder-Taste bestätigen.
- ▶ Zum Speichern der Änderungen folgende Taste drücken: .

5.2.4 Verwaltung Externer Steuerungen (Set up 602)

Ermöglicht das Verwalten externer Parameter 2 (Minimalwert, Maximalwert, Standardwert, gewählter Parameter).

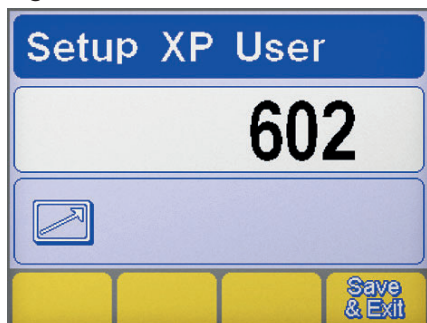

Parameterauswahl

- ▶ Gehen Sie ins Set-up hinein, indem Sie den Taster Encoder für mindestens 5 Sekunden drücken.
- ▶ Wählen Sie den gewünschten Parameter aus (602).
- ▶ Gehen Sie ins Menü "Verwaltung Externer Steuerungen" hinein, indem Sie den Taster Encoder drücken.

DE

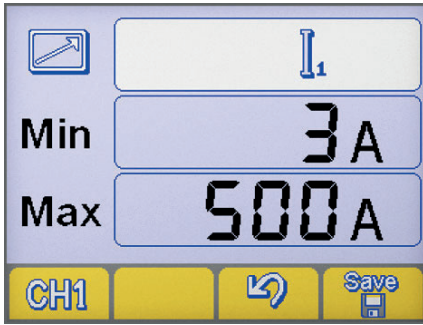

Verwaltung Externer Steuerungen

- ▶ Wählen Sie den gewünschten Ausgang der RC Fernsteuerung (CH1, CH2, CH3, CH4), indem Sie die Taste drücken
- ▶ Wählen Sie den gewünschten Parameter (Min-Max-parameter), indem Sie den Taster Encoder drücken.
- ▶ Stellen Sie den gewünschten Parameter (Min-Max-parameter) ein, indem Sie den Encoder drehen.
- ▶ Zum Speichern der Änderungen folgende Taste drücken:
- ▶ Brechen Sie den Vorgang ab, indem Sie die Taste drücken

5.2.5 Kalibrierung des Schweißkreiswiderstands (set up 705)

Ermöglicht die Einstellung des Generators auf den aktuellen Widerstand des Schweißwiderstands.

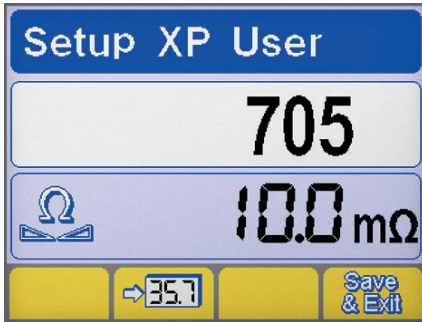

Parameterauswahl

- ▶ Gehen Sie ins Set-up hinein, indem Sie den Taster Encoder für mindestens 5 Sekunden drücken.
- ▶ Wählen Sie den gewünschten Parameter aus (705).
- ▶ Aktivieren Sie die Einstellung des gewählten Parameters, indem Sie den Taster Encoder drücken.
- ▶ Den Generator an den Schweißkreislauf anschließen (Werkbank oder Werkstück).
- ▶ Die Kappe abnehmen und die angegebene Düsenspitze des Brenners einsetzen. (MIG/MAG)

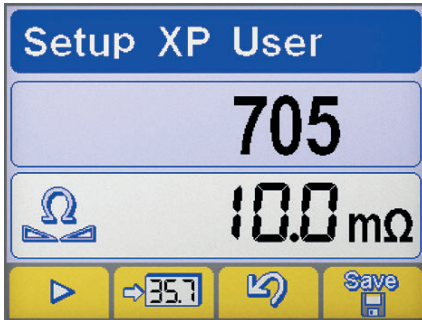

Kalibrierung

- ▶ Elektrischen Kontakt zwischen Drahtführungsspitze und Schweißwerkstück herstellen. (MIG/MAG)
- ▶ Taste zum Starten des Vorgangs drücken.
- ▶ Die Berührung muss mindestens eine Sekunde lang bestehen.
- ▶ Der am Display gezeigte Wert wird nach der Einstellung aktualisiert.
- ▶ Bestätigen Sie den Vorgang, indem Sie die Taste drücken
- ▶ Brechen Sie den Vorgang ab, indem Sie die Taste drücken
- ▶ Zum Speichern der Änderungen und Verlassen des Setups folgende Taste drücken:

5.2.6 Schutzgrenzen (Set up 801)

Ermöglicht die Einstellung der Warn- und Schutzgrenzen.

Ermöglicht die Steuerung des Schweißverfahrens, indem Warn- und Schutzgrenzen für die messbaren Hauptparameter eingestellt werden.

Ermöglicht die genaue Steuerung der verschiedenen Schweißphasen.

Siehe Abschnitt "Schutzgrenzen (Set up 801)".

Warngrenzen		Schutzgrenzen	
Schweißstrom			Schweißspannung
Gasdurchfluss-Anzeige			Geschwindigkeit der Roboterbewegung
Stromanzeige (Motor 1)			Stromanzeige (Motor 2)
Anzeige des Kühlmitteldurchflusses			Anzeige der Drahtgeschwindigkeit
Anzeige der Kühlmitteltemperatur			

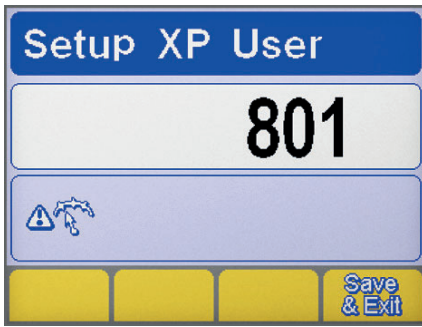

Parameterauswahl

- ▶ Gehen Sie ins Set-up hinein, indem Sie den Taster Encoder für mindestens 5 Sekunden drücken.
- ▶ Wählen Sie den gewünschten Parameter aus (801).
- ▶ Gehen Sie ins Menü "Schutzgrenzen" hinein, indem Sie den Taster Encoder drücken.

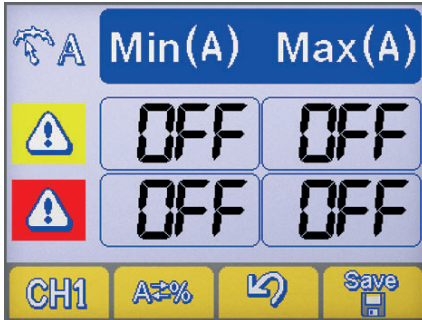

Parameterauswahl

- ▶ Wählen Sie den gewünschten Parameter, indem Sie die Taste drücken **CH1**.
- ▶ Wählen Sie die Einstellungsmethode der Schutzgrenzen, indem Sie die Taste drücken. **A=%**.

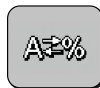

Modusauswahl



Absoluter Wert



Prozentwert

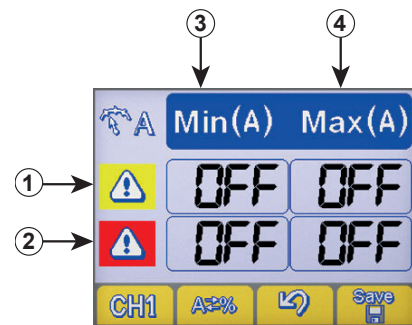

Einstellung der Schutzgrenzen

- 1 Zeile Warngrenzen
- 2 Zeile Alarmgrenzen
- 3 Spalte Minimalgrenze
- 4 Spalte Maximalgrenze

- ▶ Wählen Sie den gewünschten Kasten, indem Sie den Taster Encoder drücken (der ausgewählte Kasten wird invers dargestellt).
- ▶ Stellen Sie den Wert der gewählten Grenze ein, indem Sie den Encoder drehen.
- ▶ Zum Speichern der Änderungen folgende Taste drücken: **Save**.



Das Überschreiten einer der Schutzgrenzen lässt ein sichtbares Signal auf dem Bedienfeld erscheinen.



Das Überschreiten einer der Alarmgrenzen lässt ein sichtbares Signal auf dem Bedienfeld erscheinen und löst die sofortige Blockade des Schweißvorgangs aus.



Es ist möglich Anfangs- und Endfilter für das Schweißen einzustellen, um Fehlermeldungen während des Zündens und Erlöschens des Lichtbogens vorzubeugen (siehe Abschnitt "Set-up" - Parameter 802-803-804).

6. ZUBEHÖR

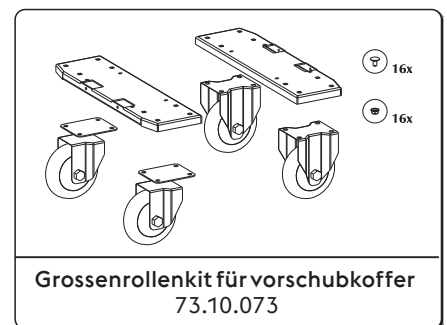
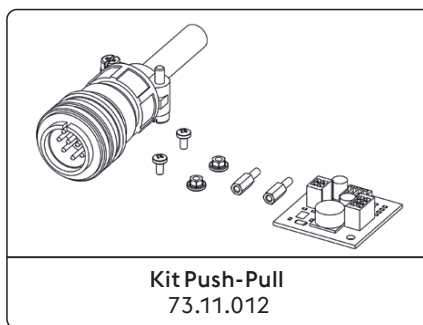
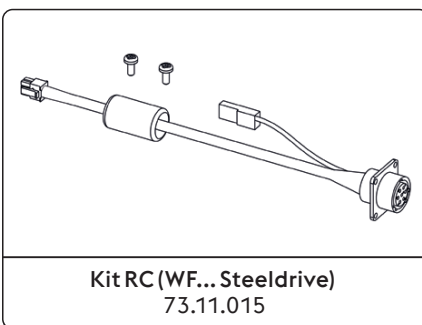

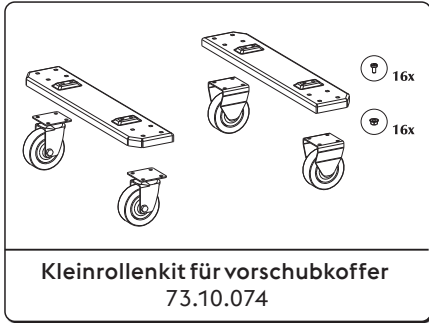

Kleinrollenkit für vorschubkoffer
73.10.074

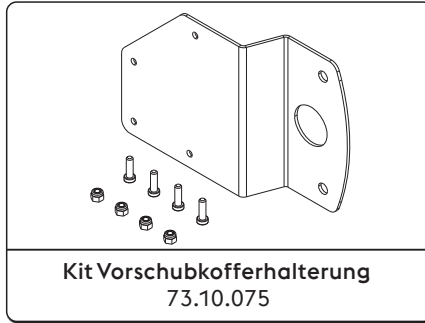

Kit Vorschubkofferhalterung
73.10.075

*Werksmontage

Siehe Abschnitt "Installation kits/zubehör".

DE

7. WARTUNG



Die regelmäßige Wartung der Anlage muss nach den Angaben des Herstellers erfolgen. Wenn das Gerät in Betrieb ist, müssen alle Zugangs-, Wartungstüren und Abdeckungen geschlossen und verriegelt sein. Die Anlage darf keiner Änderung unterzogen werden. Vermeiden Sie Ansammlungen von Metallstaub in der Nähe und über den Lüftungsschlitzen.



Jeder Wartungseingriff darf nur von Fachpersonal ausgeführt werden. Das Reparieren oder Austauschen von Anlageteilen durch unautorisiertes Personal hebt die Produktgarantie auf. Das Reparieren oder Austauschen von Anlageteilen darf ausschließlich von Fachpersonal ausgeführt werden.



Trennen Sie die Anlage von der Stromzufuhr vor jedem Wartungseingriff!

7.1 Führen Sie folgende regelmäßige Überprüfungen am Generator durch



Das Innere der Anlage mittels Druckluft mit niederem Druck und weichen Pinseln reinigen. Elektrische Verbindungen und Anschlusskabel prüfen.

7.2 Verantwortung



Durch Unterlassung der oben genannten Wartung wird jegliche Garantie aufgehoben und der Hersteller wird von jeglicher Haftung befreit. Der Hersteller übernimmt keinerlei Haftung, falls sich der Benutzer nicht an diese Vorschriften hält. Wenden Sie sich bei jedem Zweifel und/oder bei jedem Problem an die nächstgelegene Technische Kundendienststelle.

8. ALARMCODES



ALARM

Die Auslösung eines Alarms bzw. das Überschreiten einer kritischen Warnschwelle hat eine entsprechende Anzeige am Bedienfeld sowie den sofortigen Abbruch der Schweißvorgänge zur Folge.



ACHTUNG

Das Überschreiten einer Schutzgrenze verursacht ein visuelles Signal auf dem Bedienfeld, ermöglicht jedoch die Fortsetzung der Schweißvorgänge.

Nachstehend sind alle Alarmer und Warnschwellen der Anlage aufgelistet.

E01	Übertemperatur	
-----	----------------	--

E02	Übertemperatur	
-----	----------------	--

E05	Überstrom	
-----	-----------	--

E07	Fehler in der Stromversorgung des Drahtvorschubmotors	
-----	---	--

E08	Motor blockiert	
-----	-----------------	--

E10	Überstrom des Leistungsmoduls (Inverter)	
-----	--	--

E12.1	Kommunikationsfehler WF1	
-------	--------------------------	--

E13	Kommunikationsfehler (FP)	
-----	---------------------------	--

 E14.xx	Ungültiges Programm Der Untercode des Fehlers bezeichnet die Nummer des gelöschten Auftrags		 E15	Ungültiges Programm	
 E16.1	Kommunikationsfehler RI 1000/2000/3000 (CAN bus)		 E16.2	Kommunikationsfehler RI 3000 (Modbus)	
 E16.3	Kommunikationsfehler RI 1000/2000		 E18.xx	Ungültiges Programm Der Untercode des Fehlers bezeichnet die Nummer des gelöschten Auftrags	
 E19	Anlagen-Konfigurationsfehler		 E19.1	Anlagen-Konfigurationsfehler	
 E19.11	Anlagen-Konfigurationsfehler (WF)		 E20	Speicher defekt	
 E21	Datenverlust		 E23	Schweißprogramme nicht vorhanden	
 E27	Speicher defekt (RTC)		 E32	Datenverlust	
 E33.1	Anlagen-Konfigurationsfehler (LCD 3.5")		 E33.3	Kommunikationsfehler (ACTIVATION KEY)	
 E33.4	Kommunikationsfehler (ACTIVATION KEY)		 E40	Stromversorgung der Anlage Fehler	
 E43	Kühlmittelmangel		 E44	Gasmangel	
 E48	Drahtmangel (Automatisierungs- und Robotertechnik)		 E50	Draht festgeklebt (Automatisierungs- und Robotertechnik)	
 E54	Stromgrenze überschritten (Untere Grenze)		 E55	Stromgrenze überschritten (Obere Grenze)	
 E56	Spannungsgrenze überschritten (Untere Grenze)		 E57	Spannungsgrenze überschritten (Obere Grenze)	
 E58	Gasdurchflussgrenze überschritten (Untere Grenze)		 E59	Gasdurchflussgrenze überschritten (Obere Grenze)	
 E62	Stromgrenze überschritten (Untere Grenze)		 E63	Stromgrenze überschritten (Obere Grenze)	
 E64	Spannungsgrenze überschritten (Untere Grenze)		 E65	Spannungsgrenze überschritten (Obere Grenze)	
 E66	Gasdurchflussgrenze überschritten (Untere Grenze)		 E67	Gasdurchflussgrenze überschritten (Obere Grenze)	

E71	Übertemperatur des Kühlmittels		E74	Stromgrenze Motor 1 überschritten	
E76	Kühlmitteldurchflussgrenze überschritten		E77	Kühlmitteltemperaturgrenze überschritten	
E80	Drahtmangel (wire end)		E81	Überstrom (Pump-WU)	
E82	Kommunikationsfehler (WU)		E83	Pump-blockiert	
E99.2	Alarm Systemkonfiguration (inverter)		E99.3	Alarm Systemkonfiguration (FP)	
E99.4	Alarm Systemkonfiguration (FP)		E99.5	Alarm Systemkonfiguration (FP)	
E99.6	Alarm Systemkonfiguration		E99.11	Speicher defekt	

9. FEHLERSUCHE

Drahtvorschub blockiert

Ursache

- » Brenntaste defekt.
- » Rollen nicht korrekt oder abgenutzt.
- » Getriebemotor defekt.
- » Drahtführungsspirale beschädigt.
- » Drahtvorschub nicht gespeist.
- » Wicklung des Drahtes auf der Spule unregelmäßig.
- » Brennerdüse geschmolzen (Draht klebt)

Lösung

- » Schadhafte Teil ersetzen.
- » Anlage von der nächstgelegenen Kundendienststelle reparieren lassen.
- » Rollen ersetzen.
- » Schadhafte Teil ersetzen.
- » Anlage von der nächstgelegenen Kundendienststelle reparieren lassen.
- » Schadhafte Teil ersetzen.
- » Anlage von der nächstgelegenen Kundendienststelle reparieren lassen.
- » Anschluss am Generator überprüfen.
- » Siehe Kapitel "Anschluss".
- » Anlage von der nächstgelegenen Kundendienststelle reparieren lassen.
- » Verwicklung des Drahtes beheben oder Spule ersetzen.
- » Schadhafte Teil ersetzen.

Drahtvorschub unregelmäßig

Ursache

- » Brenntaste defekt.
- » Rollen nicht korrekt oder abgenutzt.
- » Getriebemotor defekt.
- » Drahtführungsspirale beschädigt.

Lösung

- » Schadhafte Teil ersetzen.
- » Anlage von der nächstgelegenen Kundendienststelle reparieren lassen.
- » Rollen ersetzen.
- » Schadhafte Teil ersetzen.
- » Anlage von der nächstgelegenen Kundendienststelle reparieren lassen.
- » Schadhafte Teil ersetzen.
- » Anlage von der nächstgelegenen Kundendienststelle reparieren lassen.

» Fehleinstellung der Spulenbremse oder der Andruckrollen.

» Spulenbremse lockern.
 » Druck auf die Andruckrollen erhöhen.

Zundereinschlüsse

Ursache

» Unvollständiges Entfernen des Zunders.
 » Elektrode mit zu großem Durchmesser.
 » Nahtvorbereitung unkorrekt.
 » Durchführung des Schweißens unkorrekt.

Lösung

» Werkstücke vor dem Schweißen sorgfältig reinigen.
 » Eine Elektrode mit kleinerem Durchmesser benutzen.
 » Abschrägung vergrößern.
 » Abstand zwischen Elektrode und Werkstück reduzieren.
 » In allen Schweißphasen ordnungsgemäß vorgehen.

Blasen

Ursache

» Schutzgas ungenügend.

Lösung

» Druckluftdurchfluss korrekt regulieren.
 » Prüfen, dass Diffusor und Gasdüse am Brenner in gutem Zustand sind.

Verklebungen

Ursache

» Bogenlänge unkorrekt.
 » Schweißparameter unkorrekt.
 » Durchführung des Schweißens unkorrekt.
 » Zu große Werkstücke.
 » Bogenlängendynamik unkorrekt.

Lösung

» Abstand zwischen Elektrode und Werkstück vergrößern.
 » Schweißspannung erhöhen.
 » Schweißstrom erhöhen.
 » Schweißspannung erhöhen.
 » Brennerneigung erhöhen.
 » Schweißstrom erhöhen.
 » Schweißspannung erhöhen.
 » Induktivitätswert des Schweißkreises erhöhen.

Einschnitte an den Rändern

Ursache

» Schweißparameter unkorrekt.
 » Bogenlänge unkorrekt.
 » Durchführung des Schweißens unkorrekt.
 » Schutzgas ungenügend.

Lösung

» Schweißstrom verringern.
 » Abstand zwischen Elektrode und Werkstück reduzieren.
 » Schweißspannung verringern.
 » Seitliche Pendelgeschwindigkeit beim Füllen reduzieren.
 » Vorschubgeschwindigkeit beim Schweißen herabsetzen.
 » Gas verwenden, das für die zu schweißenden Werkstoffe geeignet ist.

Oxydationen

Ursache

» Schutzgas ungenügend.

Lösung

» Druckluftdurchfluss korrekt regulieren.
 » Prüfen, dass Diffusor und Gasdüse am Brenner in gutem Zustand sind.

Porosität

Ursache

» Vorhandensein von Fett, Lack, Rost oder Schmutz auf den Werkstücken.
 » Vorhandensein von Feuchtigkeit im Zusatzwerkstoff.
 » Vorhandensein von Feuchtigkeit im Zusatzwerkstoff.
 » Bogenlänge unkorrekt.

Lösung

» Werkstücke vor dem Schweißen sorgfältig reinigen.
 » Immer Produkte und Materialien hochwertiger Qualität benutzen.
 » Zusatzwerkstoff immer in einwandfreiem Zustand halten
 » Immer Produkte und Materialien hochwertiger Qualität benutzen.
 » Zusatzwerkstoff immer in einwandfreiem Zustand halten
 » Abstand zwischen Elektrode und Werkstück reduzieren.
 » Schweißspannung verringern.

- » Feuchtigkeit im Schweißgas.
- » Schutzgas ungenügend.
- » Zu schnelles Erstarren des Schweißbads.
- » Immer Produkte und Materialien hochwertiger Qualität benutzen.
- » Für den einwandfreien Zustand der Gaszuleitung sorgen.
- » Druckluftdurchfluss korrekt regulieren.
- » Prüfen, dass Diffusor und Gasdüse am Brenner in gutem Zustand sind.
- » Vorschubgeschwindigkeit beim Schweißen herabsetzen.
- » Werkstücke vorwärmen.
- » Schweißstrom erhöhen.

Wärmerisse

Ursache

- » Schweißparameter unkorrekt.
- » Vorhandensein von Fett, Lack, Rost oder Schmutz auf den Werkstücken.
- » Vorhandensein von Feuchtigkeit im Zusatzwerkstoff.
- » Durchführung des Schweißens unkorrekt.
- » Ungleiche Eigenschaften der Werkstücke.

Lösung

- » Schweißstrom verringern.
- » Werkstücke vor dem Schweißen sorgfältig reinigen.
- » Immer Produkte und Materialien hochwertiger Qualität benutzen.
- » Zusatzwerkstoff immer in einwandfreiem Zustand halten
- » Den korrekten Arbeitsablauf für die zu schweißende Verbindung ausführen.
- » Vor dem Schweißen ein Puffern ausführen.

Kälterisse

Ursache

- » Vorhandensein von Feuchtigkeit im Zusatzwerkstoff.
- » Besondere Form der zu schweißenden Verbindung.

Lösung

- » Immer Produkte und Materialien hochwertiger Qualität benutzen.
- » Zusatzwerkstoff immer in einwandfreiem Zustand halten
- » Werkstücke vorwärmen.
- » Ein Nachwärmen ausführen.
- » Den korrekten Arbeitsablauf für die zu schweißende Verbindung ausführen.

10. BETRIEBSANWEISUNGEN

10.1 Schweißen mit Endlosdrahtelektroden (MIG/MAG)

Einleitung

Ein MIG-System besteht aus einem Gleichstromgenerator, einer Vorrichtung für die Drahtzuführung, einer Drahtspule und einem Gasbrenner.

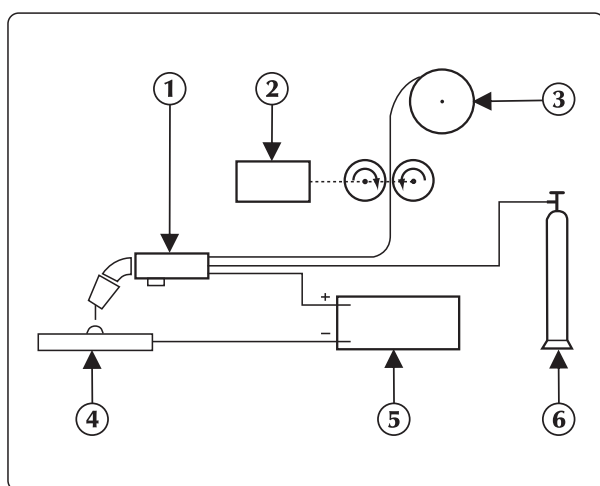

Manuelle Schweißanlage

Der Strom wird über die Schmelzelektrode (Draht mit positiver Polung) zum Bogen übertragen;

Bei diesem Verfahren wird das geschmolzene Metall durch den Bogen auf das Werkstück übertragen.

Die Drahtzuführung ist erforderlich, um den beim Schweißen geschmolzenen Elektrodendraht wieder zu ergänzen.

1. Brenner
2. Drahtvorschub
3. Schweißdraht
4. Schweißwerkstück
5. Stromquelle
6. Flasche

Verfahren

Beim Schweißen unter Schutzgas gibt es zwei Übertragungsmethoden, die sich dadurch unterscheiden, wie sich die Tropfen von der Elektrode ablösen.

Bei der ersten Methode, "KURZSCHLUSSÜBERTRAGUNG (SHORT-ARC)" genannt, tritt die Elektrode in direkten Kontakt mit dem Bad, dann wird ein Kurzschluss mit Schmelzwirkung des Drahts verursacht, der deswegen unterbrochen wird. Danach zündet der Bogen wieder und der Zyklus wiederholt sich.

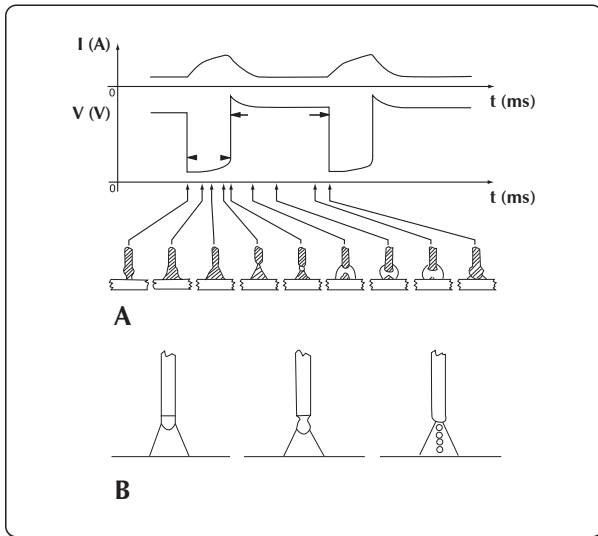

SHORT-ARC-Zyklus und SPRAY-ARC-Schweißung

Die zweite Methode für die Übertragung der Tropfen ist die sogenannte "SPRITZERÜBERTRAGUNG (SPRAY-ARC)", wobei sich die Tropfen von der Elektrode ablösen und erst danach das Schmelzbad erreichen.

DE

Schweißparameter

Die Sichtbarkeit des Bogens verringert die Notwendigkeit einer genauesten Beachtung der Einstelltabellen durch den Schweißer, da er die Möglichkeit hat, das Schmelzbad direkt zu kontrollieren.

- Die Spannung hat einen direkten Einfluss auf das Aussehen der Schweißnaht, aber die Abmessungen der geschweißten Oberfläche können je nach Bedarf variiert werden, indem die Brennerbewegung von Hand getätigt wird, so dass man verschiedenartige Ablagerungen bei konstanter Spannung erhält.
- Die Drahtvorschubgeschwindigkeit ist proportional zum Schweißstrom.

In folgenden zwei Abbildungen werden die Beziehungen zwischen den verschiedenen Schweißparametern veranschaulicht.







Tabelle zur wahl der schweissparameter mit bezug auf die typischsten anwendungen und die am häufigsten benutzten schweissdrähte

Bogenspannung	Ø 0,8 mm	Ø 1,0-1,2 mm	Ø 1,6 mm	Ø 2,4 mm
16V - 22V SHORT - ARC				
	60 - 160 A Geringe Durchdringung bei dünnem Material	100 - 175 A Gute Kontrolle der Durchdringung und der Schmelzung	120 - 180 A Gute horizontale und vertikale Schmelzung	150 - 200 A Nicht verwendet
24V - 28V SEMI SHORT-ARC (Übergangsbereich)				
	150 - 250 A Automatisches Kehlnahtschweißen	200 - 300 A Automatisches Hochspannungsschweißen	250 - 350 A Automatisches Abwärtsschweißen	300 - 400 A Nicht verwendet
30V - 45V SPRAY - ARC				
	150 - 250 A Geringe Durchdringung mit Einstellung auf 200 A	200 - 350 A Automatisches Schweißen mit mehreren Schweißlagen	300 - 500 A Gute Durchdringung beim Abwärtsschweißen	500 - 750 A Gute Durchdringung und hohe Ablagerung auf dickem Material

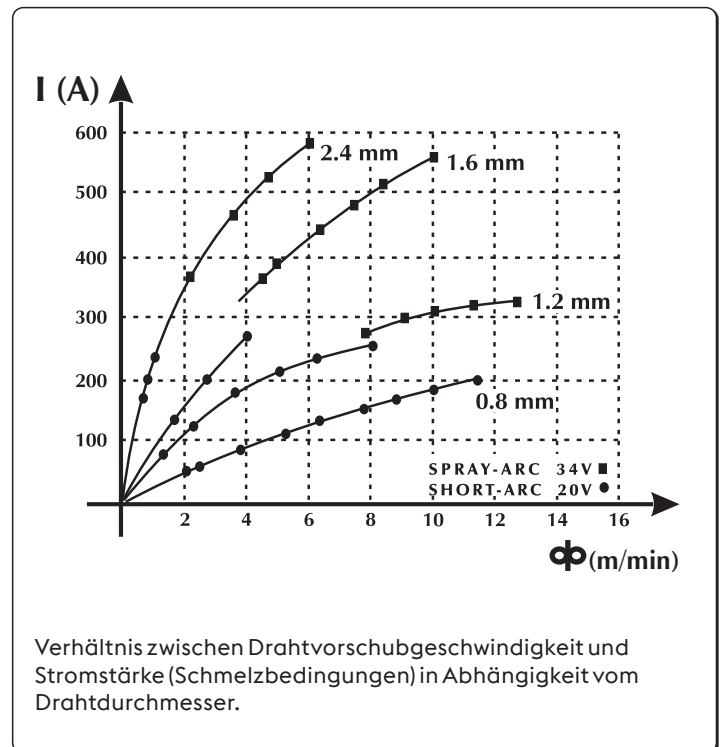
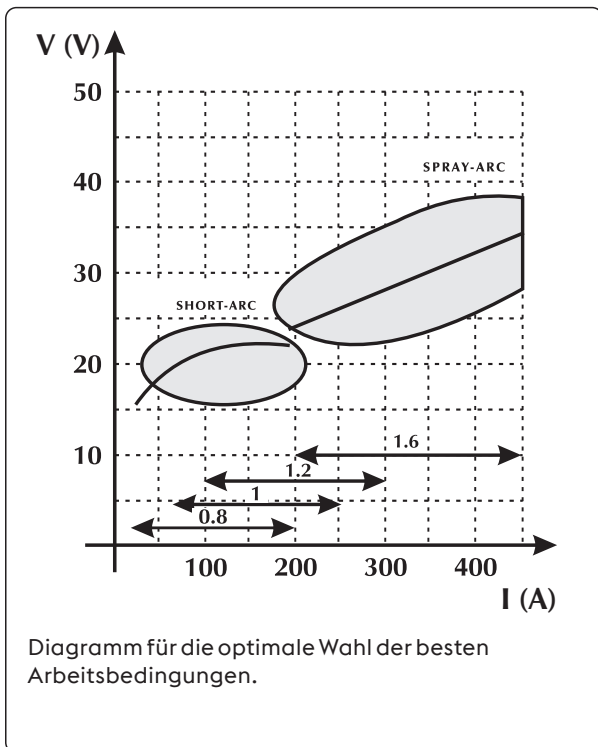
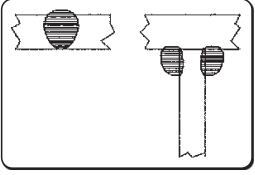
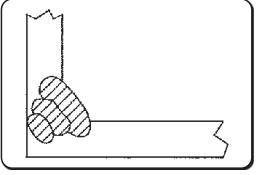
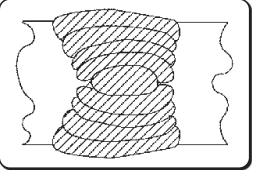
Unalloyed steel

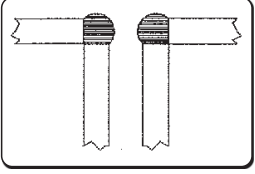
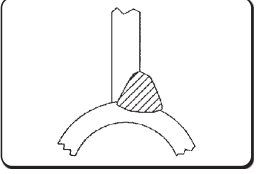
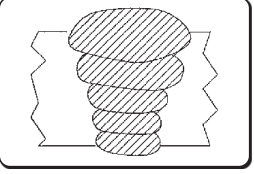

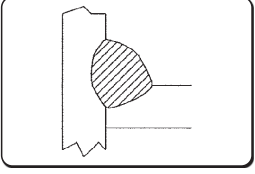
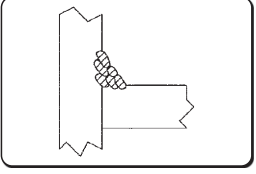
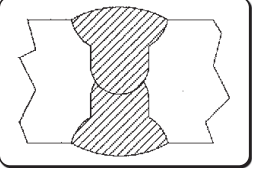
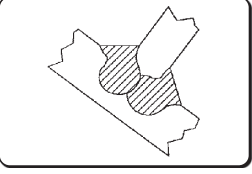
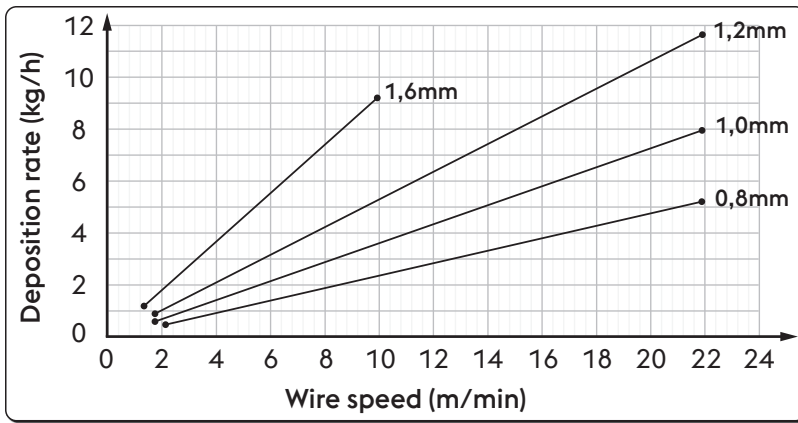
Ø	Wire speed	Deposition rate
0,8 mm	2,0 m/min	0,5 kg/h
	22,0 m/min	5,3 kg/h
1,0 mm	1,6 m/min	0,6 kg/h
	22,0 m/min	8,1 kg/h
1,2 mm	1,6 m/min	0,9 kg/h
	22,0 m/min	11,7 kg/h
1,6 mm	1,2 m/min	1,1 kg/h
	10,0 m/min	9,4 kg/h

DE

High alloyed steel

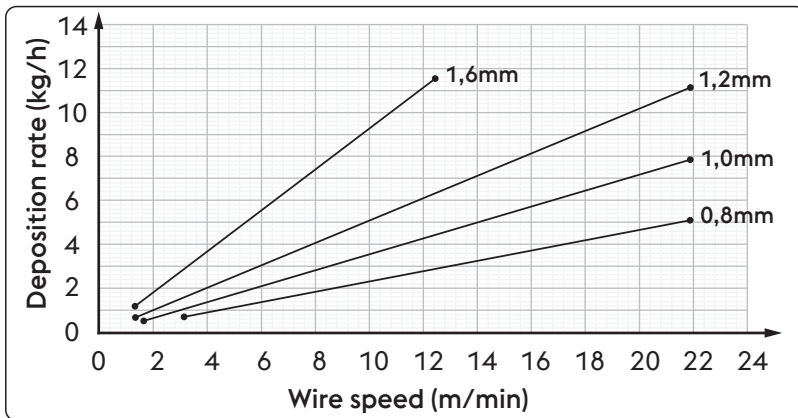

Ø	Wire speed	Deposition rate
0,8 mm	2,0 m/min	0,5 kg/h
	22,0 m/min	5,3 kg/h
1,0 mm	1,6 m/min	0,6 kg/h
	22,0 m/min	8,1 kg/h
1,2 mm	1,6 m/min	0,9 kg/h
	22,0 m/min	11,7 kg/h
1,6 mm	1,2 m/min	1,1 kg/h
	10,0 m/min	9,4 kg/h

Aluminum alloy

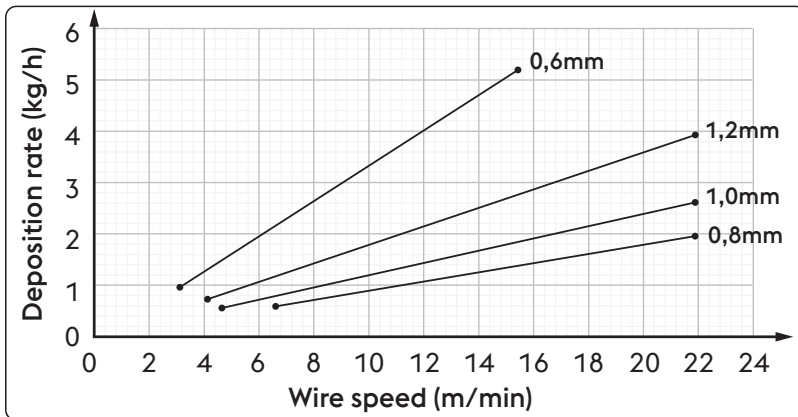

Ø	Wire speed	Deposition rate
0,8 mm	6,5 m/min	0,6 kg/h
	22,0 m/min	2,0 kg/h
1,0 mm	4,5 m/min	0,5 kg/h
	22,0 m/min	2,6 kg/h
1,2 mm	4,0 m/min	0,7 kg/h
	22,0 m/min	4,0 kg/h
1,6 mm	3,0 m/min	0,9 kg/h
	15,5 m/min	5,2 kg/h

Verwendbare Gase

Die MIG-MAG-Schweißung ist vor allem durch den verwendeten Gastyp gekennzeichnet, Inertgase für das MIG-Schweißen (Metal Inert Gas), und Aktivgase für das MAG-Schweißen (Metal Active Gas).

- Kohlendioxid (CO₂)

Mit CO₂ als Schutzgas werden hohe Durchdringungen mit guter Vorschubgeschwindigkeit und guten mechanischen Eigenschaften bei geringen Betriebskosten erreicht. Der Gebrauch dieses Gases verursacht jedoch erhebliche Probleme, was die chemische Endzusammensetzung der Verbindungen betrifft, da man einen Verlust an leicht oxidierbaren Elementen hat und das Bad gleichzeitig mit Kohlenstoff angereichert wird.

Das Schweißen mit reinem CO₂ ist auch Grund für andere Probleme, wie zu viele Spritzer und Bildung von Porositäten durch Kohlenmonoxid.

- Argon

Dieses Inertgas wird in reiner Form beim Schweißen von Leichtlegierungen verwendet, wogegen man zum Schweißen von rostfreiem Chrom-Nickelstahl einen 2%-igen Zusatz von Sauerstoff und CO₂ vorzieht, der zur Bogenstabilität und zu einer besseren Form der Schweißnaht beiträgt.

- Helium

Dieses Gas wird anstelle von Argon benutzt und ermöglicht bessere Durchdringungen (auf dickem Material) und höhere Vorschubgeschwindigkeiten.

- Argon-Helium-Mischung

Im Vergleich zu reinem Helium erhält man einen stabileren Bogen, mit mehr Durchdringung und größerer Vorschubgeschwindigkeit als mit Argon.

- Argon-CO₂ -Mischung und Argon-CO₂ -Sauerstoff-Mischung

Diese Mischungen werden beim Schweißen von Eisenmaterial verwendet, vor allem beim SHORT-ARC-Schweißen, da der spezifische Wärmezusatz verbessert wird.

Dies schließt aber den Gebrauch dieser Mischungen für das SPRAY-ARC-Schweißen nicht aus.

Die Mischung enthält gewöhnlich einen CO₂-Anteil von 8% bis 20% und einen O₂-Anteil um 5%.

Lesen Sie die Bedienungsanleitung der Anlage.

Unalloyed steel / High alloyed steel		Aluminum alloy	
Strombereich	Gasdurchfluss	Strombereich	Gasdurchfluss
3-50 A	10-12 l/min	3-50 A	10-12 l/min
30-100 A	10-14 l/min	30-100 A	10-15 l/min
75-150 A	12-16 l/min	75-150 A	12-18 l/min
150-250 A	14-18 l/min	150-250 A	14-22 l/min
250-400 A	16-20 l/min	250-400 A	16-25 l/min
400-500 A	18-22 l/min	400-500 A	18-30 l/min

11. TECHNISCHE DATEN

Eigenschaften der Drahtvorschubeinheit WF NX 430 SteelDrive		U.M.
Getriebemotor	SL4R-4T	
Getriebemotorleistung	120	W
Rollenzahl	4	
Drahtdurchmesser / Standard Rollen	1.0-1.2	mm
Geeignete Drahtdurchmesser / Lenkbare Rollen	Drahtvorschubgeschwindigkeit 0.8-1.6 mm Aluminiumdraht 1.2-2.4 Fülldrahtstahl	mm/Material
Gasprüftaste	ja	
Taste für Drahtvorschub	ja	
Drahrückzug-taste	nein	
Drahtvorschubgeschwindigkeit	25 Ø 0.8 - 1.0	m/min
Synergie	ja	
Externe Geräte	ja (wahlfrei)	
Steckerbuchse für Push-Pull-Brenner	ja (wahlfrei)	
Spule	200/300	mm
Durchmesser der vorderen Räder	63/125 (optional)	mm
Durchmesser der hinteren Räder	63/125 (optional)	mm
Elektrische Eigenschaften WF NX 430 SteelDrive		U.M.
Versorgungsspannung U1	48	Vdc
Kommunikation-Bus	DIGITAL	
Max. Stromaufnahme I1max	4.5	A
Nutzungsfaktor WF NX 430 SteelDrive		U.M.
Nutzungsfaktor (40°C)		
(X=50%)	500	A
(X=60%)	470	A
(X=100%)	420	A
Nutzungsfaktor (25°C)		
(X=80%)	500	A
(X=100%)	470	A
Physikalische Eigenschaften WF NX 430 SteelDrive		U.M.
Schutzart IP	IP23S	
Abmessungen (LxBxH)	640x250x460	mm
Gewicht	19.0	Kg
Konstruktionsnormen	EN IEC 60974-5:2019 EN 60974-10/A1:2015	

12. LEISTUNGSSCHILDER

VOESTALPINE BÖHLER WELDING SELCO S.R.L. Via Palladio,19 - ONARA (PADOVA) - ITALY			
WF NX 430		N°	
EN 60974-5:2019 IEC 60974-10/A1:2015 Class A			
	X (40°C)	60%	100%
	I ₂	500A	400A
	U ₁ 48V	I _{1max} 4.5A	
IP 23 S		UK CA CE EAC	
MADE IN ITALY			

DE

13. BEDEUTUNG DER ANGABEN AUF DEM LEISTUNGSSCHILD

1		2	
3		4	
5			
	6	6A	6B
	7	7A	7B
8	9	10	
11		UK CA CE EAC	
MADE IN ITALY			

- 1 Marke
- 2 Herstellername und -adresse
- 3 Gerätemodell
- 4 Seriennummer
- XXXXXXXXXXXXX Baujahr
- 5 Hinweis auf die Konstruktionsnormen
- 6 Symbol für den unterbrochenen Betrieb
- 7 Symbol des Nenn-Schweißstroms
- 6A Werte für den unterbrochenen Betrieb
- 6B Werte für den unterbrochenen Betrieb
- 7A Werte des Nenn-Schweißstroms
- 7B Werte des Nenn-Schweißstroms
- 8 Symbol der Stromversorgung
- 9 Versorgungs-Nennspannung
- 10 Maximale Nennstromaufnahme
- 11 Schutzart

CE EU-Konformitätserklärung
 EAC EAC-Konformitätserklärung
 UKCA UKCA-Konformitätserklärung

DÉCLARATION DE CONFORMITÉ UE

Le constructeur

voestalpine Böhler Welding Selco S.r.l. - Via Palladio, 19 - 35019 Onara di Tombolo (PD) - ITALY
Tél. +39 049 9413/111 - Fax +39 049 9413/311 - www.voestalpine.com/welding

déclare sous sa seule responsabilité que le produit suivant:

WF NX 430 STEELDRIVE **71.01.083**

est conforme aux directives EU:

2014/35/EU **LOW VOLTAGE DIRECTIVE**

2014/30/EU **EMC DIRECTIVE**

2011/65/EU **RoHS DIRECTIVE**

et que les normes harmonisées suivantes ont été appliquées:

EN IEC 60974-5:2019

WIRE FEEDERS

EN 60974-10/A1:2015

ELECTROMAGNETIC COMPATIBILITY REQUIREMENTS

La documentation certifiant le respect des directives sera tenue à disposition pour les inspections chez le fabricant susmentionné.

Toute intervention ou modification non autorisée par voestalpine Böhler Welding Selco S.r.l. annulera la validité de cette déclaration.

Onara di Tombolo, 03/07/2023

voestalpine Böhler Welding Selco s.r.l.

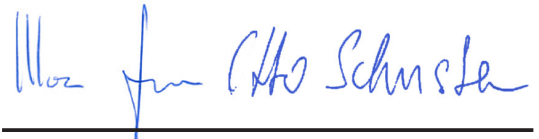

Mirco Frasson

Otto Schuster

Managing Directors

INDEX GENERAL

1. AVERTISSEMENT	119
1.1 Environnement d'utilisation	119
1.2 Protection individuelle et de l'entourage	119
1.3 Protection contre les fumées et les gaz	120
1.4 Prévention contre le risque d'incendie et d'explosion	120
1.5 Prévention dans l'emploi de bouteilles de gaz	121
1.6 Protection contre les décharges électriques	121
1.7 Champs électromagnétiques et interférences	121
1.8 Degré de protection IP	122
1.9 Élimination	122
2. INSTALLATION	122
2.1 Mode de soulèvement, de transport et de déchargement	123
2.2 Installation de l'appareil	123
2.3 Branchement et raccordement	123
2.4 Mise en service	123
3. PRÉSENTATION DE L'APPAREIL	125
3.1 Panneau arrière	125
3.2 Panneau prises	125
3.3 Panneau de commande frontal	126
4. UTILISATION DE L'INSTALLATION	127
4.1 Ecran de démarrage	127
4.2 Ecran de test	127
4.3 Ecran principal	127
5. MENU SET UP	131
5.1 Set up et paramétrage des paramètres	131
5.2 Procédures spécifiques d'utilisation des paramètres	140
6. ACCESSOIRES	144
7. ENTRETIEN	144
7.1 Contrôles périodiques sur le générateur	144
7.2 Responsabilité	144
8. CODES D'ALARMES	145
9. DIAGNOSTIC ET SOLUTIONS	146
10. MODE D'EMPLOI	149
10.1 Soudage en continu (MIG/MAG)	149
11. CARACTÉRISTIQUES TECHNIQUES	153
12. PLAQUE DONNÉES	154
13. SIGNIFICATION DE LA PLAQUE DES DONNÉES	154
14. SCHÉMA	459
15. CONNECTEURS	460
16. LISTE DE PIÈCES DÉTACHÉES	461
17. INSTALLATION KIT/ACCESSOIRES	464

SYMBOLOGIE



Dangers imminents qui causent de graves lésions et comportements risqués qui pourraient causer de graves lésions.



Comportements qui pourraient causer des lésions sans gravité ou des dommages aux biens.



Les notes précédées par ce symbole sont de caractère technique et facilitent les opérations.

1. AVERTISSEMENT



Avant de commencer toute opération, assurez-vous d'avoir bien lu et bien compris ce manuel.

N'apportez pas de modification et n'effectuez pas d'opération de maintenance si elles ne sont pas indiquées dans ce manuel. Le fabricant n'est pas responsable des dommages causés aux personnes ou aux objets en cas de non-respect ou de mise en pratique incorrecte des instructions de ce manuel.

Les Instructions de service doivent être conservées en permanence sur le lieu d'utilisation de l'appareil. En complément des présentes instructions de service, les règles générales et locales en vigueur concernant la prévention des accidents et la protection de l'environnement doivent être respectées.



Toutes les personnes concernées par la mise en service, l'utilisation, la maintenance et la remise en état de l'appareil doivent:

- posséder les qualifications correspondantes
- avoir des connaissances en soudage
- lire attentivement et suivre avec précision les prescriptions des présentes Instructions de service

Prière de consulter du personnel qualifié en cas de doute ou de problème sur l'utilisation de l'installation, même si elle n'est pas décrite ici.

1.1 Environnement d'utilisation



Chaque installation ne doit être utilisée que dans le but exclusif pour lequel elle a été conçue, de la façon et dans les limites prévues sur la plaque signalétique et/ou dans ce manuel, selon les directives nationales et internationales relatives à la sécurité. Un usage autre que celui expressément déclaré par le fabricant doit être considéré comme inapproprié et dangereux et décharge ce dernier de toute responsabilité.



Cet appareil doit être utilisé exclusivement dans un but professionnel, dans un environnement industriel. Le fabricant n'est pas responsable des dommages causés en cas d'usage domestique.



L'installation doit être utilisée dans un local dont la température est comprise entre -10 et +40°C (entre +14 et +104°F).

L'installation doit être transportée et stockée dans un local dont la température est comprise entre -25 et +55°C (entre -13 et 131°F).

L'installation doit être utilisée dans un local sans poussière, ni acide, ni gaz ou autres substances corrosives.

L'installation ne doit pas être utilisée dans un local dont le taux d'humidité dépasse 50% à 40°C (104°F).

L'installation ne doit pas être utilisée dans un local dont le taux d'humidité dépasse 90% à 20°C (68°F).

L'installation ne doit pas être utilisée à une altitude supérieure à 2000 m au dessus du niveau de la mer (6500 pieds).



Ne pas utiliser cet appareil pour décongeler des tuyaux.

Ne pas utiliser cet appareil pour recharger des batteries et/ou des accumulateurs.

Ne pas utiliser cet appareil pour démarrer des moteurs.

1.2 Protection individuelle et de l'entourage



Le procédé de soudage constitue une source nocive de radiations, de bruit, de chaleur et d'émanations gazeuses. Installer une cloison de séparation ignifuge afin de protéger la zone de soudage des rayons, projections et déchets incandescents. Rappeler aux personnes dans la zone de soudage de ne fixer ni les rayons de l'arc, ni les pièces incandescentes et de porter des vêtements de protection appropriés.



Porter des vêtements de protection afin de protéger la peau contre les rayons de l'arc, les projections ou contre le métal incandescent. Les vêtements portés doivent couvrir l'ensemble du corps et:

- être en bon état
- être ignifuges
- être isolants et secs
- coller au corps et ne pas avoir de revers



Toujours porter des chaussures conformes aux normes, résistantes et en mesure de bien isoler de l'eau.

Toujours utiliser des gants conformes aux normes et en mesure de garantir l'isolation électrique et thermique.



Utiliser un masque avec des protections latérales pour le visage et un filtre de protection adéquat pour les yeux (au moins NR10 ou supérieur).



Toujours porter des lunettes de sécurité avec des coques latérales, particulièrement lors du nettoyage manuel ou mécanique des cordons de soudage.



Ne pas utiliser de lentilles de contact!



Utiliser un casque contre le bruit si le procédé de soudage atteint un niveau de bruit dangereux. Si le niveau de bruit dépasse les limites prescrites par la loi, délimiter la zone de travail et s'assurer que les personnes qui y accèdent portent un casque ou des bouchons de protection.



Toujours laisser les panneaux latéraux fermés durant les opérations de soudage. L'installation ne doit absolument pas être modifiée. Veiller à ce que les mains, les cheveux, les vêtements, les outils ... ne soient pas en contact avec des pièces en mouvement tels que: ventilateurs, engrenages, galets et arbres, bobines de fil. Ne pas toucher les galets lorsque le dévidage du fil est activé. Ôter les dispositifs de protection sur les dévidoirs est extrêmement dangereux et décharge le fabricant de toute responsabilité en cas d'accident ou de dommages sur des personnes ou sur des biens.



Ne pas approcher la tête de la torche MIG/MAG durant le chargement et l'avancement du fil. Le fil en sortant peut provoquer des blessures graves aux mains, au visage et aux yeux.



Éviter de toucher les pièces qui viennent d'être soudées car la forte chaleur pourrait provoquer des brûlures graves. Suivre également toutes les précautions indiquées plus haut en fin de soudage car des résidus en cours de refroidissement pourraient se détacher des pièces usinées.



S'assurer que la torche est froide avant d'intervenir dessus ou d'effectuer une opération d'entretien quelconque.



S'assurer que le groupe de refroidissement est éteint avant de déconnecter les tuyaux de circulation du liquide réfrigérant. Le liquide chaud en sortie pourrait provoquer des brûlures graves.



Avoir à disposition une trousse de secours. Ne pas sous-estimer les brûlures ou les blessures.



Avant de quitter le poste de travail, sécuriser la zone afin d'empêcher tout risque d'accident ou de dommages aux personnes ou aux biens.

1.3 Protection contre les fumées et les gaz



Les fumées, les gaz et les poussières produits par le procédé de soudage peuvent être nocifs pour la santé.

Les fumées qui se dégagent durant le processus de soudage peuvent, dans certaines circonstances, provoquer le cancer ou nuire au fœtus chez les femmes enceintes.

- Veiller à ne pas être en contact avec les gaz et les fumées de soudage.
- Prévoir une ventilation adéquate, naturelle ou forcée, dans la zone de travail.
- En cas d'aération insuffisante, utiliser un masque à gaz spécifique.
- En cas d'opérations de soudage dans des locaux de petites dimensions, il est conseillé de faire surveiller l'opérateur par un collègue situé à l'extérieur.
- Ne pas utiliser d'oxygène pour la ventilation.
- S'assurer que l'aspiration est efficace en contrôlant régulièrement si les gaz nocifs ne dépassent pas les valeurs admises par les normes de sécurité.
- La quantité et le niveau de risque des fumées produites dépendent du métal de base utilisé, du métal d'apport et des substances éventuelles utilisées pour nettoyer et dégraisser les pièces à souder. Suivre attentivement les instructions du fabricant et les fiches techniques correspondantes.
- Ne pas effectuer d'opérations de soudage à proximité d'ateliers de dégraissage ou de peinture.
- Placer les bouteilles de gaz dans des endroits ouverts ou dans un local bien aéré.

1.4 Prévention contre le risque d'incendie et d'explosion



Le procédé de soudage peut causer des incendies et/ou des explosions.

- Débarrasser la zone de travail et ses abords de tous les matériaux et objets inflammables ou combustibles.
- Les matériaux inflammables doivent se trouver à au moins 11 mètres (35 pieds) de la zone de soudage et être entièrement protégés.
- Les projections et les particules incandescentes peuvent facilement être projetées à distance, même à travers des fissures. Veiller à ce que les personnes et les biens soient à une distance suffisante de sécurité.
- Ne pas effectuer de soudures sur ou à proximité de récipients sous pression.
- Ne pas effectuer d'opérations de soudage ou de découpage sur des containers ou des tubes fermés. Faire très attention au moment de souder des tuyaux ou des containers, même ouverts, vidés et nettoyés soigneusement. Des résidus de gaz, de carburant, d'huile ou autre pourraient provoquer une explosion.
- Ne pas souder dans une atmosphère contenant des poussières, des gaz ou des vapeurs explosives.
- S'assurer, en fin de soudage, que le circuit sous tension ne peut pas toucher accidentellement des pièces connectées au circuit de masse.
- Installer à proximité de la zone de travail un équipement ou un dispositif anti-incendie.

1.5 Prévention dans l'emploi de bouteilles de gaz



Les bouteilles de gaz inertes contiennent du gaz sous pression et peuvent exploser si les conditions requises en matière de transport, de conservation et d'utilisation ne sont pas garanties.

- Les bouteilles doivent être rangées verticalement contre le mur ou contre un support et être maintenues par des moyens appropriés pour qu'elles ne tombent pas et éviter des chocs mécaniques accidentels.
- Visser le capuchon pour protéger la valve durant le transport ou la mise en service et chaque fois que les opérations de soudage sont terminées.
- Ne pas laisser les bouteilles au soleil et ne pas les exposer aux gros écarts de températures trop élevées ou trop extrêmes. Ne pas exposer les bouteilles à des températures trop basses ou trop élevées.
- Veiller à ce que les bouteilles ne soient pas en contact avec une flamme, avec un arc électrique, avec une torche ou une pince porte-électrodes, ni avec des projections incandescentes produites par le soudage.
- Garder les bouteilles loin des circuits de soudage et des circuits électriques en général.
- Éloigner la tête de l'orifice de sortie du gaz au moment d'ouvrir la valve de la bouteille.
- Toujours refermer la valve de la bouteille quand les opérations de soudage sont terminées.
- Ne jamais souder une bouteille de gaz sous pression.
- Ne jamais relier une bouteille d'air comprimé directement au réducteur de pression de la machine! Si la pression dépasse la capacité du réducteur, celui-ci pourrait exploser!

1.6 Protection contre les décharges électriques



Une décharge électrique peut être mortelle.

- Éviter de toucher les parties normalement sous tension à l'intérieur ou à l'extérieur de l'installation de soudage quand cette dernière est alimentée (les torches, les pinces, les câbles de masse, les électrodes, les fils, les galets et les bobines sont branchés au circuit de soudage).
- Garantir l'isolation de l'installation et de l'opérateur en utilisant des sols et des plans secs et suffisamment isolés de la terre.
- S'assurer que l'installation soit connectée correctement à une fiche et à un réseau muni d'un conducteur de mise à la terre.
- Ne pas toucher en même temps deux torches ou deux pinces porte-électrodes.
- Interrompre immédiatement les opérations de soudage en cas de sensation de décharge électrique.

1.7 Champs électromagnétiques et interférences



Le passage du courant dans les câbles à l'intérieur et à l'extérieur de l'installation crée un champ électromagnétique à proximité de cette dernière et des câbles de soudage.

- Les champs électromagnétiques peuvent avoir des effets (jusqu'ici inconnus) sur la santé de ceux qui y sont exposés pendant un certain temps.
- Les champs électromagnétiques peuvent interférer avec d'autres appareils tels que les stimulateurs cardiaques ou les appareils acoustiques.



Les personnes qui portent un stimulateur cardiaque (pacemaker) ou un appareil auditif doivent consulter le médecin avant d'effectuer des opérations de soudure à l'arc.

1.7.1 Classification CEM selon la norme: EN 60974-10/A1:2015.

Classe
B

Los dispositivos de clase B cumplen con los requisitos de compatibilidad electromagnética en entornos industriales y residenciales, incluyendo las áreas residenciales en las que la energía eléctrica se suministra desde un sistema público de baja tensión.

Classe
A

Los dispositivos de clase A no están destinados al uso en áreas residenciales en las que la energía eléctrica se suministra desde un sistema público de baja tensión. Il pourrait être difficile d'assurer la compatibilité électromagnétique d'appareils de classe A dans de tels environnements, en raison de perturbations par rayonnement ou conduction.

Pour plus d'informations, consultez le chapitre: PLAQUE DONNÉES ou CARACTÉRISTIQUES TECHNIQUES.

1.7.2 Installation, utilisation et évaluation de la zone

Ce matériel a été fabriqué conformément aux dispositions relatives à la norme harmonisée EN 60974-10/A1:2015 et est considéré comme faisant partie de la "CLASSE A". Cet appareil doit être utilisé exclusivement dans un but professionnel, dans un environnement industriel. Le fabricant n'est pas responsable des dommages causés en cas d'usage domestique.



L'utilisateur, qui doit être un expert dans le domaine, est responsable en tant que tel de l'installation et de l'utilisation de l'appareil selon les instructions du constructeur. Si des perturbations électromagnétiques apparaissent, il est de la responsabilité de l'utilisateur de résoudre le problème en demandant conseil au service après-vente du constructeur.



Dans tous les cas, les perturbations électromagnétiques doivent être réduites de manière à ne plus représenter une gêne.



Avant l'installation de l'appareil, l'utilisateur devra évaluer les problèmes électromagnétiques potentiels qui pourraient survenir aux abords de la zone de travail et en particulier sur la santé des personnes situées à proximité (personnes portant un pacemaker ou un appareil auditif).

1.7.3 Précautions concernant les câbles

Se conformer aux règles suivantes pour réduire les effets des champs électromagnétiques:

- Enrouler l'un avec l'autre et fixer, quand cela est possible, le câble de masse et le câble de puissance.
- Ne jamais enrouler les câbles autour du corps.
- Ne pas se placer entre le câble de masse et le câble de puissance (les mettre tous les deux du même côté).
- Les câbles doivent rester les plus courts possible, être placés proche l'un de l'autre à même le sol ou près du niveau du sol.
- Placer l'installation à une certaine distance de la zone de soudage.
- Les câbles ne doivent pas être placés à proximité d'autres câbles.

1.7.4 Branchement equipotentiel

Le branchement à la masse de tous les composants métalliques de l'installation de soudage (découpage) et adjacents à cette installation doit être envisagé. Respecter les normes nationales concernant la branchement equipotentiel.

1.7.5 Mise a la terre de la pièce à souder

Quand la pièce à souder n'est pas reliée à la terre, pour des motifs de sécurité électrique ou à cause de son encombrement et de sa position, un branchement reliant la pièce à la terre pourrait réduire les émissions. Il faut veiller à ce que la mise à la terre de la pièce à souder n'augmente pas le risque d'accident pour les utilisateurs ou de dommages sur d'autres appareils électriques. Respecter les normes nationales concernant la mise à la terre.

1.7.6 Blindage

Le blindage sélectif d'autres câbles et appareils présents à proximité de la zone peut réduire les problèmes d'interférences. Le blindage de toute l'installation de soudage peut être envisagé pour des applications spéciales.

1.8 Degré de protection IP



IP23S

- Boîtier de protection contre l'accès aux parties dangereuses par un doigt et contre des corps solides étrangers ayant un diamètre supérieur/égal à 12.5 mm.
- Grille de protection contre une pluie tombant à 60°.
- Boîtier protégé contre les effets nuisibles dus à la pénétration d'eau lorsque les parties mobiles de l'appareil ne sont pas encore en fonctionnement.

1.9 Élimination



Ne pas éliminer les équipements électriques avec les déchets ménagers !

Conformément à la Directive européenne 2012/19/UE relative aux déchets d'équipements électriques et électroniques et à sa mise en œuvre conformément aux lois nationales, les équipements électriques qui ont atteint la fin de leur cycle de vie doivent être collectés séparément et envoyés à un centre de récupération et d'élimination. Le propriétaire de l'équipement doit identifier les centres de collecte agréés en se renseignant auprès des autorités locales. L'application de la Directive Européenne permettra de respecter l'environnement et la santé des êtres humains.

» Pour plus d'informations, consulter le site.

2. INSTALLATION



L'installation ne peut être effectuée que par du personnel expérimenté et agréé par le constructeur.



Pendant l'installation, s'assurer que le générateur est déconnecté du réseau.

2.1 Mode de soulèvement, de transport et de déchargement

- L'appareil est équipé d'une poignée permettant le portage à la main.
- La machine ne dispose d'aucun élément spécifique pour le levage.
- Utiliser un chariot élévateur à fourches en faisant très attention au moment de déplacer le générateur afin d'éviter de le faire basculer.



Ne pas sous-évaluer le poids de l'installation, se reporter aux caractéristiques techniques.

Ne pas faire passer ou arrêter la charge suspendue au-dessus de personnes ou d'objets.

Ne pas laisser tomber le matériel ou ne pas créer de pression inutile sur l'appareil.

2.2 Installation de l'appareil



Observer les règles suivantes:

- Réserver un accès facile aux commandes et aux connexions de l'appareil.
- Ne pas installer l'appareil dans des locaux de petites dimensions.
- Ne jamais placer la machine sur un plan incliné de plus de 10° par rapport à l'horizontale.
- Installer le matériel dans un endroit sec, propre et avec une aération appropriée.
- Mettre l'installation à l'abri de la pluie battante et ne pas l'exposer aux rayons du soleil.

2.3 Branchement et raccordement



Les unités mobiles ne sont alimentées qu'en basse tension.

2.4 Mise en service

2.4.1 Raccordement pour le soudage MIG/MAG

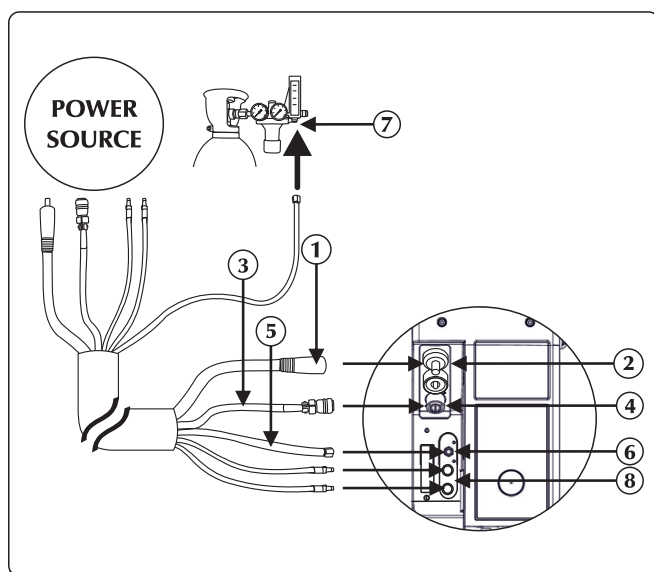

- ① Câble de puissance
- ② Raccord de puissance positive (+)
- ③ Câble de signal
- ④ Entrée câble d'interface
- ⑤ Tuyau gaz
- ⑥ Raccord du gaz
- ⑦ Raccordement de l'alimentation en gaz
- ⑧ Branchement du liquide de refroidissement

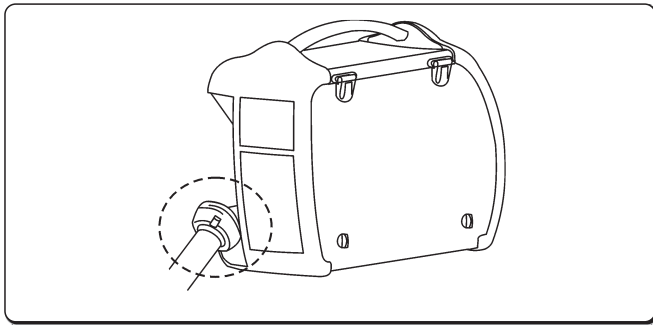

- ▶ Brancher le câble de puissance au connecteur correspondant. Introduire la prise et tourner dans le sens des aiguilles d'une montre jusqu'à ce que les parties soient bien fixées.
- ▶ Brancher le câble d'interface au connecteur correspondant. Introduire le connecteur et tourner la bague dans le sens des aiguilles d'une montre jusqu'à un serrage parfait et sécurisé des pièces.
- ▶ Relier le tuyau de gaz au réducteur de pression de la bouteille ou au raccord d'alimentation du gaz. Régler le débit du gaz de 10 à 30 l/min.
- ▶ Relier le tuyau du liquide de refroidissement (symbole bleu) au raccord rapide (symbole bleu) de sortie du refroidisseur.
- ▶ Relier le tuyau du liquide de refroidissement (symbole rouge) au raccord rapide d'entrée (symbole rouge) du refroidisseur.
- ▶ Connecter le câble d'interface CAN-BUS pour le contrôle des dispositifs externes (tels que RC, RI ...) au connecteur approprié.

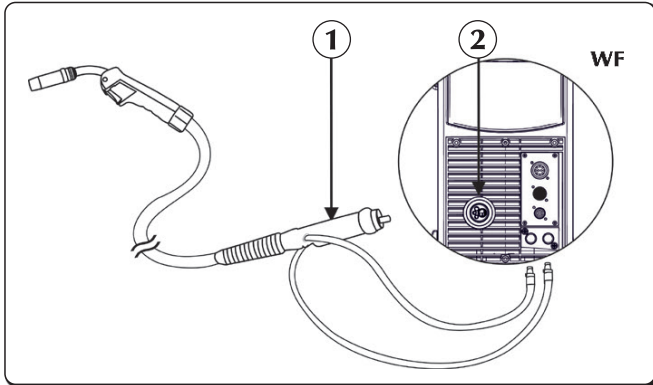

Consulter la section « Installation accessoires ».



- ① Raccord torche
- ② Connecteur

- ▶ Relier le tuyau du liquide de refroidissement de la torche (symbole rouge) au raccord rapide d'entrée (symbole rouge ) du refroidisseur.
- ▶ Relier le tuyau du liquide de refroidissement de la torche (symbole bleu) au raccord rapide (symbole bleu ) de sortie du refroidisseur.
- ▶ Brancher la torche MIG/MAG au raccord central, en s'assurant du bon serrage de la connexion.

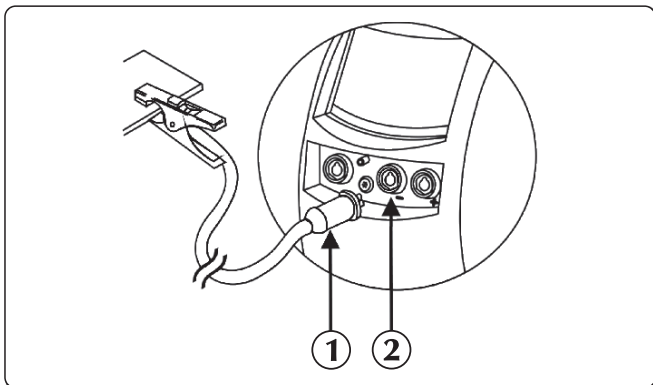

- ① Connecteur de pince de terre
- ② Raccord de puissance négative (-)

- ▶ Brancher le connecteur du câble de la pince de masse à la prise négative (-) du générateur. Introduire la prise et tourner dans le sens des aiguilles d'une montre jusqu'à ce que les parties soient bien fixées.

Compartment moteur

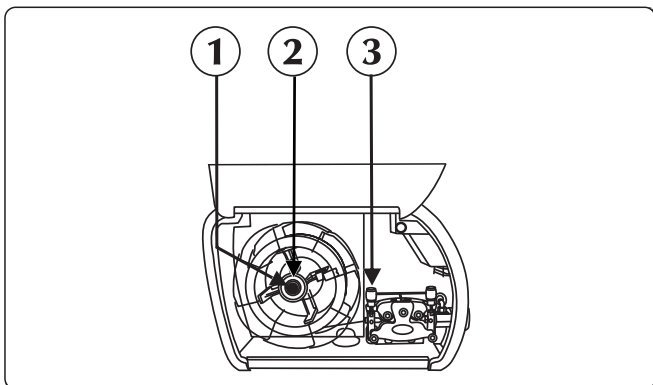

- ① Vis de maintien
- ② Frein d'inertie
- ③ Molette de pression

- ▶ Ouvrir le panneau latéral droit.
- ▶ Contrôler si la gorge du galet correspond au diamètre du fil à utiliser.

FR

- ▶ Desserrer la vis de maintien de la bobine du dévidoir et placer la bobine.
- ▶ Insérer l'ergot du support de bobine dans le logement approprié, remonter la vis de maintien et ajuster le frein d'inertie.
- ▶ Libérer la molette de pression, engager le fil dans le guide-fil, puis dans la gorge des galets, puis dans la torche. Bloquer la molette de pression.
- ▶ Appuyer sur la gâchette d'avancement du fil pour l'engager dans la torche.
- ▶ Régler le débit du gaz de 10 à 30 l/min.

3. PRÉSENTATION DE L'APPAREIL

3.1 Panneau arrière

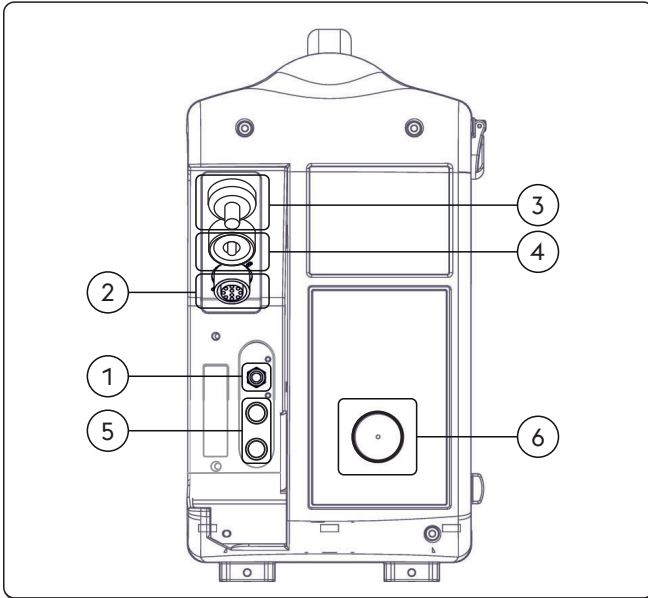

- ① Raccord gaz
- ② Entrée du câble de signal (CAN-BUS) (faisceau de câbles)
- ③ Entrée du câble d'alimentation (faisceau de câbles)
- ④ Raccord de puissance positive (+)
- ⑤ Entrée/sortie du liquide de refroidissement
- ⑥ Entrée de fil

FR

3.2 Panneau prises

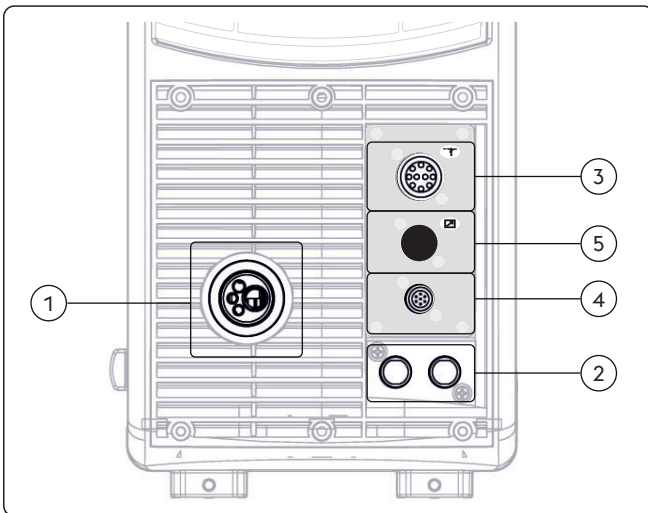





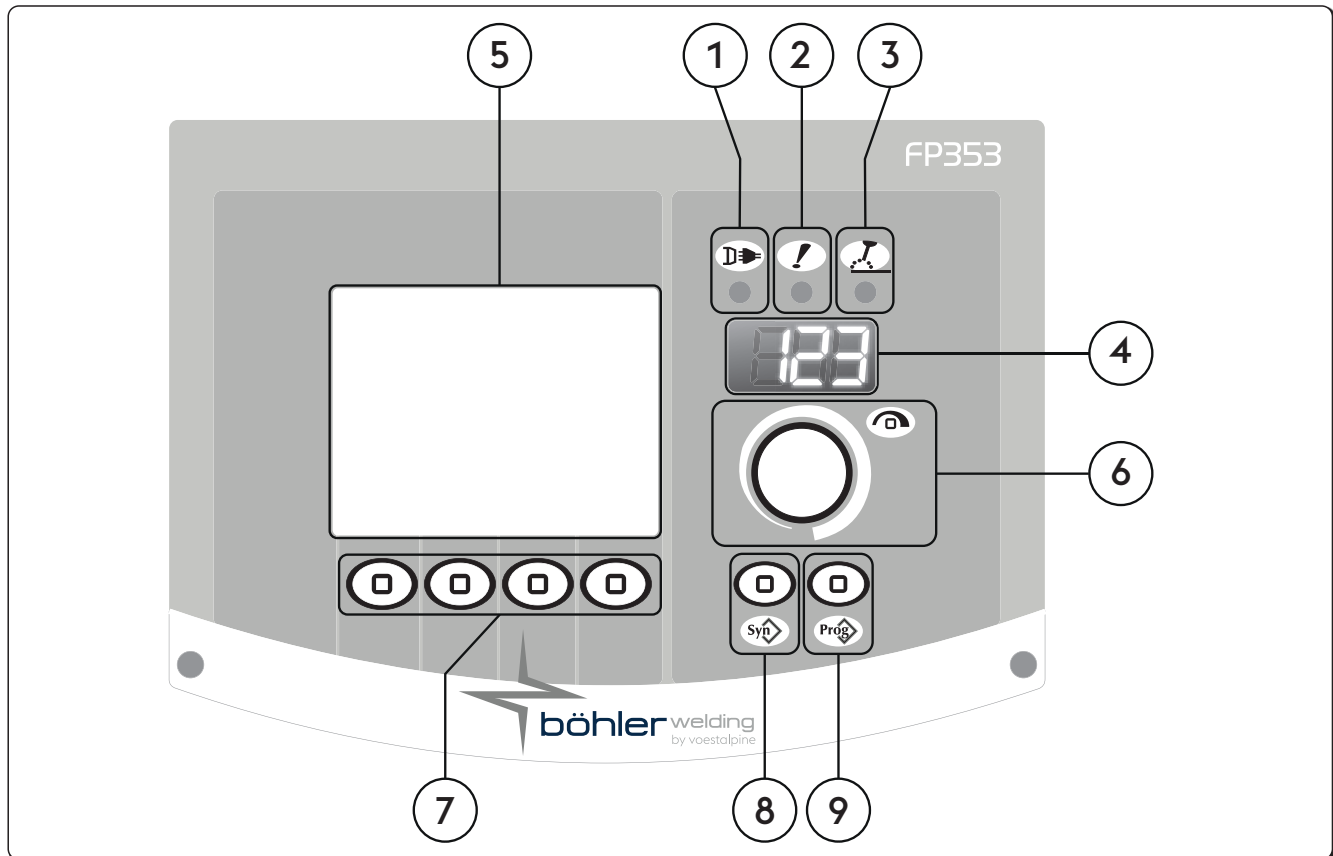

- ① Raccord torche
Il permet la connexion de la torche MIG/MAG.
- ② Branchement du liquide de refroidissement
- ③ Entrée câble d'interface (Push-Pull)
- ④ Entrée du câble de signal (torche)
Connexion de la torche
- ⑤ Entrée câble d'interface (RC)

3.3 Panneau de commande frontal



FR

- ①  **LED d'alimentation**
Indique que le générateur est connecté au réseau et qu'il est sous tension.
- ②  **LED d'alarme générale**
Indique l'intervention possible des systèmes de protection, tels que la protection thermique.
- ③  **LED de puissance active**
Indique la présence de tension sur les connexions de sortie du générateur.
- ④  **Affichage des données**
Permet l'affichage des différents paramètres de soudage lors de la mise en route, des réglages, la lecture de l'intensité et de la tension pendant le soudage, ainsi que la codification des défauts.
- ⑤  **LCD display**
Permet l'affichage des différents paramètres de soudage lors de la mise en route, des réglages, la lecture de l'intensité et de la tension pendant le soudage, ainsi que la codification des défauts.
Permet l'affichage instantané de toutes les opérations.
- ⑥  **Bouton de réglage principal**
Permet l'accès au menu et la sélection et le réglage des paramètres de soudage.
- ⑦  **Touches de fonction**
Permet la sélection des diverses fonctions du système:

 - Proceso de soldadura
 - Procédures de soudage
 - Courant de pulsation
 - Mode graphique

8 Touches programmes de soudage

Permet la sélection d'un programme de soudage préselectionné en choisissant quelques réglages simples:

- Type de fil
- Type de gaz
- Diamètre de fil

9 Touche job

4. UTILISATION DE L'INSTALLATION

4.1 Ecran de démarrage

Dès sa mise en route, le générateur va procéder à une série de tests afin de garantir le fonctionnement correct de l'appareil et des dispositifs connectés. A ce stade, le test gaz est également activé pour vérifier la connexion correcte du système d'alimentation gaz.

4.2 Ecran de test

Lorsque le panneau latéral (compartiment bobine) est ouvert, les opérations de soudage sont indisponibles. L'écran test apparaît sur l'afficheur LCD.

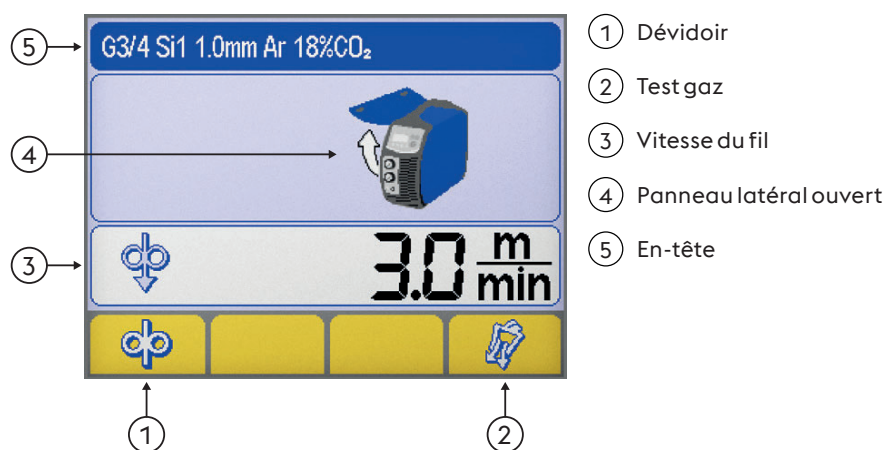

Dévidoir

Permet l'avance manuelle du fil sans apport de gaz et sans que le fil soit alimenté.
Permet l'insertion du fil dans la gaine de torche durant les phases de préparation du soudage.



Test gaz

Permet au circuit de gaz de se libérer d'éventuelles impuretés et de procéder aux réglages préliminaires de débit et de pression de gaz sans que l'alimentation soit branchée.



Vitesse du fil

Permet le réglage de la vitesse d'avance de fil (au cours de l'étape de chargement).

Minimum	Maximum	Réglage par défaut
0.5 m/min	22.0 m/min	3.0 m/min



Panneau latéral ouvert



En-tête

Permet l'affichage de certaines informations importantes relatives au procédé sélectionné.

4.3 Ecran principal

Permet la gestion de l'équipement et du procédé de soudage, en affichant les réglages principaux.

FR

4.4 Écran principal du procédé MIG/ MAG

Écran de base

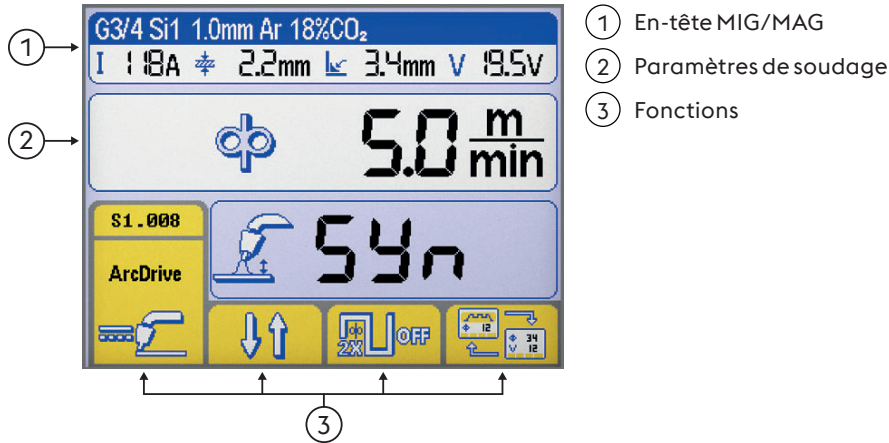

Écran graphique

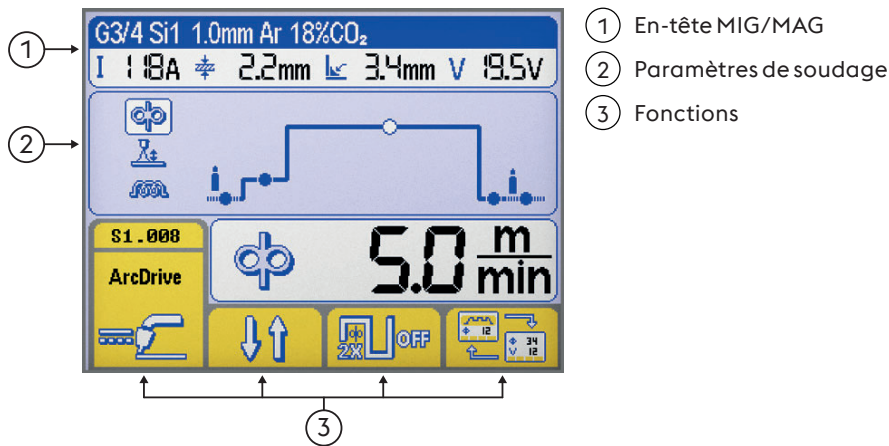

En-tête MIG/MAG

Permet l'affichage de certaines informations importantes relatives au procédé sélectionné.

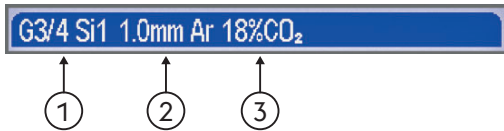

Courbe synergique sélectionnée

- ① Type de métal d'apport
- ② Diamètre de fil
- ③ Type de gaz

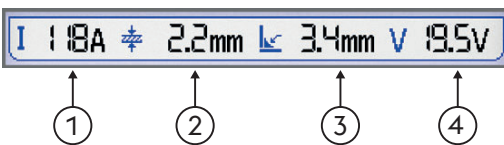

Paramètres de soudage

- ① Courant de soudage
- ② Épaisseur de la pièce
- ③ Cordon d'angle "a"
- ④ Tension de soudage

Paramètres de soudage (Écran de base)

► Sélectionner le paramètre choisi en appuyant sur le bouton de réglage.

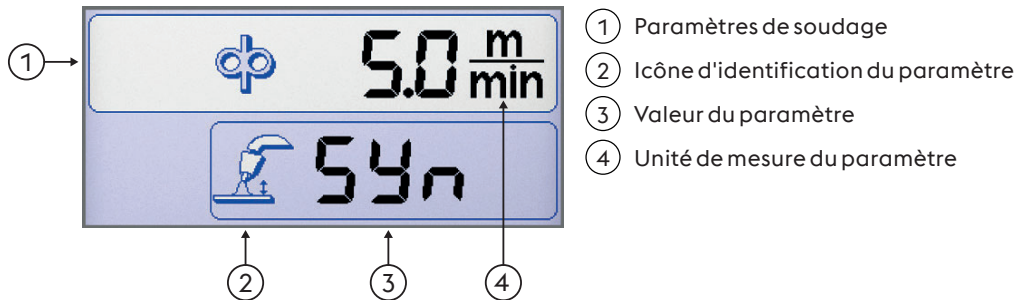

Paramètres de soudage (Écran graphique)

► Sélectionner le paramètre choisi en appuyant sur le bouton de réglage.

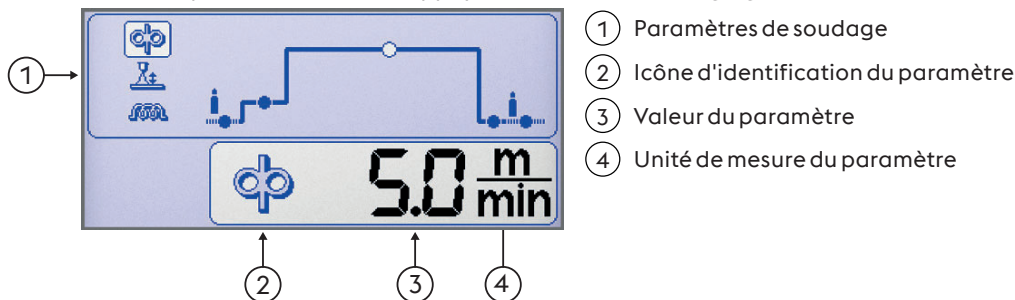

Fonctions

Permet la sélection des plus importantes fonctions de procédé et de mode de soudage.

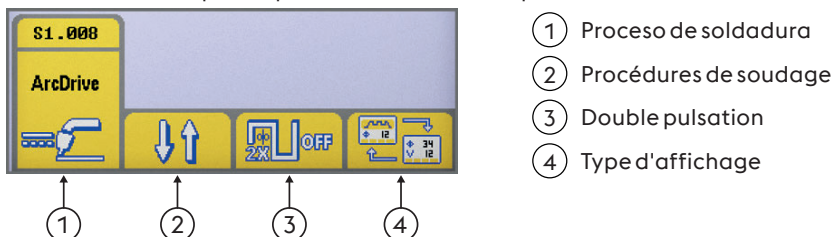

Procédures de soudage

Permet la sélection du mode de soudage



2 Temps

En mode 2 temps, une pression sur la gâchette libère le gaz, alimente la tension du fil et active son dévidage; relâcher la gâchette stoppe le gaz, la tension et le dévidage du fil.



4 Temps

En mode 4 temps, une première pression sur la gâchette libère le gaz pendant le temps de pré-gaz manuel. Relâcher la gâchette active la tension du fil et son dévidage. La pression suivante stoppe l'avance fil et active le dernier processus qui ramène l'intensité à zéro. Relâcher la gâchette provoque l'arrêt de l'alimentation du gaz.



Evanouissement (anti-crater)

Permet au soudeur le contrôle et l'accès direct par la gâchette à 3 niveaux de soudage.

Une première pression libère le gaz, alimente la tension du fil qui active son dévidage à une vitesse pré-réglée dans les paramètres initiaux et selon des valeurs synergiques relatives aux paramètres de soudage.

Relâcher la gâchette permet à la vitesse de fil et aux paramètres synergiques relatifs de revenir automatiquement aux valeurs de départ enregistrées sur le panneau de commande.

Une nouvelle pression sur la gâchette permet à la vitesse de fil et aux paramètres synergiques relatifs de retrouver les valeurs de paramètres d'anti-cratère pré-réglés durant la préparation.

Relâcher la gâchette provoque l'arrêt du dévidage du fil et enclenche le burn back (retour de fil) et le temps de post-gaz.



Double pulsation



Double pulsation actif



Double pulsation non actif

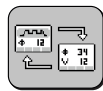

Type d'affichage

Permet de changer l'affichage entre :



Écran de base



Écran graphique

Écran de courbes synergiques



Synergie

Permet la sélection d'un programme de soudage préselectionné (synergie) en choisissant quelques réglages simples

Sélection du procédé de soudage

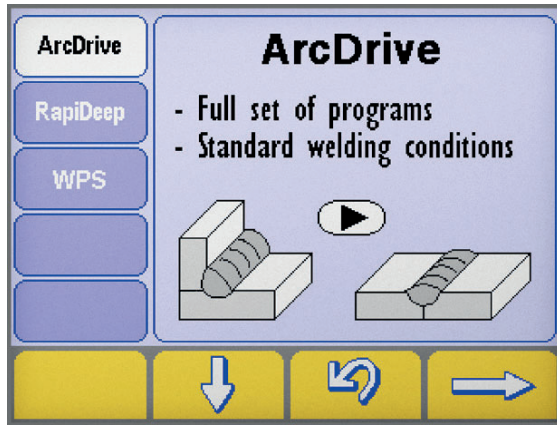

- ▶ Entrer dans l'écran « synergies » en appuyant sur la touche pendant au moins une seconde.
- ▶ Sélectionner le procédé souhaité en appuyant sur les touches et .
- ▶ Appuyez sur la touche pour passer à l'étape suivante.

FR



Écran de sélection de la synergie du type de matériau/gaz

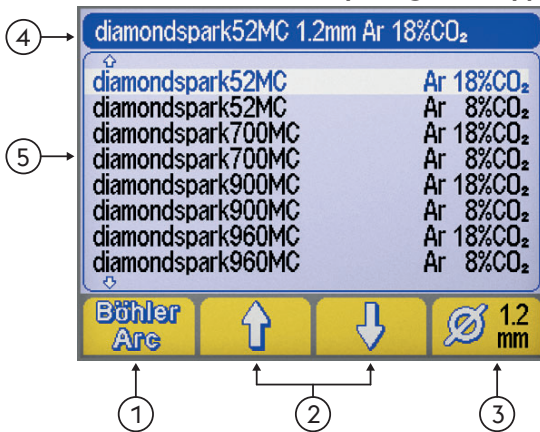

- ① Programme de soudage (BöhlerArc/UniversalArc)
- ② Sélection du matériau/gaz
- ③ Diamètre de fil
- ④ En-tête
- ⑤ Programme de soudage



Programme de soudage

Permet la sélection du programme de soudage



BöhlerArc



UniversalArc



Sélection du matériau/gaz

Permet de régler:



- Type de métal d'apport
- Type de gaz



Diamètre de fil

Permet la sélection du diamètre de fil utilisé (mm).

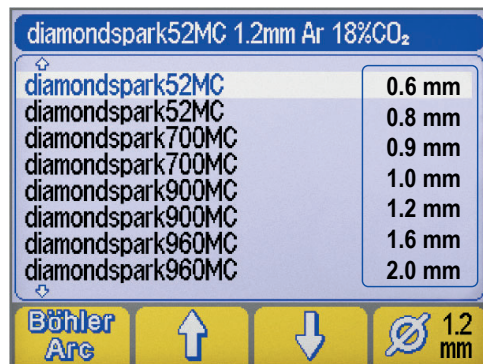

- ① Diamètre de fil



En-tête

Permet l'affichage de certaines informations importantes relatives au procédé sélectionné.

PAS DE PROGRAMME

Indique que le programme de synergie sélectionné n'est pas disponible ou n'est pas compatible avec les réglages de l'autre installation.

5. MENU SET UP

5.1 Set up et paramétrage des paramètres

Il permet de saisir et de régler toute une série de paramètres supplémentaires pour une gestion plus précise du système de soudage.

Les paramètres présents dans le menu set up sont organisés en fonction du processus de soudage sélectionné et possèdent un code numérique.

Entrée dans le menu set up



- ▶ Il suffit d'appuyer pendant 5 secondes sur la touche encodeur.
- ▶ L'entrée sera confirmée par la mention 0 sur l'écran.

Sélection et réglage du paramètre désiré

- ▶ Tourner le potentiomètre pour afficher le code numérique relatif au paramètre désiré.
- ▶ Le fait d'appuyer sur le potentiomètre permet alors d'afficher la valeur saisie pour le paramètre sélectionné et le réglage correspondant.

Sortie du menu set up

- ▶ Appuyer de nouveau sur le potentiomètre pour quitter la section "réglage".
- ▶ Se placer sur le paramètre "0" (memoriser et quitter) et appuyer sur potentiomètre pour quitter le menu set up.
- ▶ Annuler l'opération par une pression sur la touche .
- ▶ Pour enregistrer la modification et quitter la configuration, appuyez sur la touche: .

5.1.1 Liste des paramètres du menu set up (MMA)

0
Mémoriser et quitter

Cette touche permet de mémoriser les modifications et de quitter le menu set up.

1
Réinitialisation (reset)

Cette touche permet de ramener tous les paramètres à la valeur par défaut.

3
Surintensité à l'amorçage

Il permet de régler la valeur de hot start en MMA.

Permet d'avoir un démarrage plus ou moins "chaud" durant les phases d'amorçage de l'arc, ce qui facilite en fait les opérations de démarrage.

Électrode basique

Minimum	Maximum	Réglage par défaut	par
0/off	500%	80%	

Électrode cellulosique

Minimum	Maximum	Réglage par défaut	par
0/off	500%	150%	

Électrode CrNi

Minimum	Maximum	Réglage par défaut	par
0/off	500%	100%	

Électrode aluminium

Minimum	Maximum	Réglage par défaut	par
0/off	500%	120%	

Électrode de fonte

Minimum	Maximum	Réglage par défaut	par
0/off	500%	100%	

7

Courant de soudage

Il permet de régler le courant de soudage.



Minimum	Maximum	Réglage par défaut	par
3 A	I _{max}	100 A	

8

Arc force

Il permet de régler la valeur de l'Arc force en MMA.

Permet d'avoir une réponse dynamique plus ou moins énergétique durant le soudage, ce qui facilite en fait le travail du soudeur.



Augmenter la valeur de l'arc force pour réduire les risques de collage de l'électrode.

Électrode basique

Minimum	Maximum	Réglage par défaut	par
0/off	500%	30%	

Électrode cellulosique

Minimum	Maximum	Réglage par défaut	par
0/off	500%	350%	

Électrode CrNi

Minimum	Maximum	Réglage par défaut	par
0/off	500%	30%	

Électrode aluminium

Minimum	Maximum	Réglage par défaut	par
0/off	500%	100%	

Électrode de fonte

Minimum	Maximum	Réglage par défaut	par
0/off	500%	70%	

204

Dynamic power control (DPC)

Permet aux caractéristiques V/I choisies d'être sélectionnées.



I=C Courant constant

L'augmentation ou la diminution de la hauteur d'arc n'a aucun effet sur le courant de soudage exigé.

Recommandé pour l'électrode: Basique, Rutile, Acide, Acier, Fontes

1÷20 Diminution du gradient de contrôle

L'augmentation de la hauteur d'arc entraîne une baisse du courant de soudage (et vice versa) selon une valeur imposée de 1 à 20 Amps par volt.

Recommandé pour l'électrode: Cellulosique, Aluminium

P=C Puissance constante

L'augmentation de la hauteur d'arc entraîne une baisse du courant de soudage (et vice versa) selon la règle: V·I=K

Recommandé pour l'électrode: Cellulosique, Aluminium

312

Tension de coupure de l'arc

Pour saisir la valeur de tension à laquelle l'arc électrique est obligé de s'éteindre.



Cette fonction permet de gérer les différentes conditions de fonctionnement qui se présentent.

Durant la phase de soudure point par point par exemple, une basse tension de coupure de l'arc réduit le réamorçage de l'arc lorsque l'on éloigne l'électrode de la pièce, réduisant ainsi les projections, les brûlures et l'oxydation de cette dernière.

S'il faut utiliser des électrodes qui demandent une haute tension, il est au contraire conseillé de saisir un seuil haut pour éviter que l'arc ne s'éteigne durant le soudage.



Ne jamais saisir une tension de coupure d'arc supérieure à la tension à vide du générateur.

Électrode basique

Minimum	Maximum	Réglage par défaut	par
0/off	99.9 V	57.0 V	

Électrode cellulosique

Minimum	Maximum	Réglage par défaut	par
0/off	99.9 V	70.0 V	

399 Vitesse de découpage

Permet de régler la vitesse de soudage.
 Default cm/min: vitesse de référence en soudage manuel.
 Syn: valeur sinergique.

Minimum	Maximum	Réglage par défaut
1 cm/min	200 cm/min	15 cm/min

500 Configuration de la machine

Permet la sélection de l'interface graphique exigée.
 Permet l'accès aux niveaux les plus hauts du set-up (sélection).
 Consulter le paragraphe "Personnalisation d'interface (Set up 500)"

Valor	Interface Utilisateur	Valor	Niveau sélectionné
XE	Mode Simple	USER	Utilisateur
XA	Mode Avancé	SERV	Service
XP	Mode Expert	vaBW	vaBW

551 Lock/unlock

Permet le blocage d'accès au panneau de commandes et la possibilité d'insérer un code de protection.
 Consulter le paragraphe "Lock/unlock (Set up 551)".

552 Tonalité du vibreur sonore

Pour régler la tonalité du vibreur sonore.

Minimum	Maximum	Réglage par défaut
0/off	10	10

601 Réglage graduel

Permet le réglage graduel d'un paramètre qui peut être personnalisé par l'opérateur.

Minimum	Maximum	Réglage par défaut
1	lmax	1

602 Paramètre externe CH1, CH2, CH3, CH4

Permet la gestion du paramètre externe 1, 2, 3, 4 (valeur minimum, valeur maximum, valeur par défaut, paramètre sélectionné).
 Consulter le paragraphe "Gestion des commandes externes (Set up 602)".

705 Calibration de résistance du circuit

Permet l'étalonnage du système.
 Consulter le paragraphe "Calibration de résistance du circuit (set up 705)".

751 Lecture du courant

Permet l'affichage de la valeur réelle du courant de soudage.

752 Lecture de la tension

Permet l'affichage de la valeur réelle de la tension de soudage.

768 Mesure de l'apport de chaleur HI

Permet de lire la valeur de la mesure de l'apport thermique en soudage.

801 Limites de sécurité

Permet la sélection des limites d'avertissement et de sécurité.
 Permet de contrôler le procédé de soudage en mettant des limites de sécurité et d'avertissement sur les principaux paramètres de soudage mesurables.
 Permet le contrôle précis des différentes phases de soudage.
 Consulter le paragraphe "Limites de sécurité (Set up 801)".

FR

5.1.2 Liste des paramètres de configuration (TIG)

0 Mémoriser et quitter



Cette touche permet de mémoriser les modifications et de quitter le menu set up.

1 Réinitialisation (reset)



Cette touche permet de ramener tous les paramètres à la valeur par défaut.

7 Courant de soudage



Il permet de régler le courant de soudage.

Minimum	Maximum	Réglage par défaut
3 A	I _{max}	100 A

399 Vitesse de découpage



Permet de régler la vitesse de soudage.

Default cm/min: vitesse de référence en soudage manuel.

Syn: valeur sinergique.

Minimum	Maximum	Réglage par défaut
1 cm/min	200 cm/min	10 cm/min

500 Configuration de la machine



Permet la sélection de l'interface graphique exigée.

Permet l'accès aux niveaux les plus hauts du set-up (sélection).

Consulter le paragraphe "Personnalisation d'interface (Set up 500)"

Valor	Interface Utilisateur
XE	Mode Simple
XA	Mode Avancé
XP	Mode Expert

Valor	Niveau sélectionné
USER	Utilisateur
SERV	Service
vaBW	vaBW

551 Lock/unlock



Permet le blocage d'accès au panneau de commandes et la possibilité d'insérer un code de protection.

Consulter le paragraphe "Lock/unlock (Set up 551)".

552 Tonalité du vibreur sonore



Pour régler la tonalité du vibreur sonore.

Minimum	Maximum	Réglage par défaut
0/off	10	10

601 Réglage graduel



Permet le réglage graduel d'un paramètre qui peut être personnalisé par l'opérateur.

Minimum	Maximum	Réglage par défaut
1	I _{max}	1

602 Paramètre externe CH1, CH2, CH3, CH4



Permet la gestion du paramètre externe 1, 2, 3, 4 (valeur minimum, valeur maximum, valeur par défaut, paramètre sélectionné).

Consulter le paragraphe "Gestion des commandes externes (Set up 602)".

705 Calibration de résistance du circuit



Permet l'étalonnage du système.

Consulter le paragraphe "Calibration de résistance du circuit (set up 705)".



751 Lecture du courant

Permet l'affichage de la valeur réelle du courant de soudage.



752 Lecture de la tension

Permet l'affichage de la valeur réelle de la tension de soudage.



758 Vitesse du mouvement robot

Permet l'affichage de la vitesse du mouvement du bras d'un robot ou d'un dispositif d'automatisation.



768 Mesure de l'apport de chaleur HI

Permet de lire la valeur de la mesure de l'apport thermique en soudage.



801 Limites de sécurité

Permet la sélection des limites d'avertissement et de sécurité.

Permet de contrôler le procédé de soudage en mettant des limites de sécurité et d'avertissement sur les principaux paramètres de soudage mesurables.

Permet le contrôle précis des différentes phases de soudage.

Consulter le paragraphe "Limites de sécurité (Set up 801)".

5.1.3 Liste des paramètres de configuration (MIG/MAG)

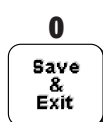

0 Mémoriser et quitter

Cette touche permet de mémoriser les modifications et de quitter le menu set up.



1 Réinitialisation (reset)

Cette touche permet de ramener tous les paramètres à la valeur par défaut.

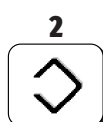

2 Programmes de soudage

MIG/MAG standard:

Permet la sélection du procédé de soudage MIG manuel (Off) ou MIG synergique (6) par l'enregistrement du matériau à souder.

MIG/MAG pulsé:

Permet la sélection du procédé de soudage MIG synergique (6) par l'enregistrement du matériau à souder.

Permet la sélection du procédé de soudage CC/CV.

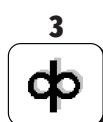

3 Vitesse du fil

Permet le réglage de la vitesse d'avance de fil.

Minimum	Maximum	Réglage par défaut
0.5 m/min	22.0 m/min	-

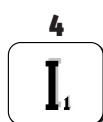

4 Courant

Il permet de régler le courant de soudage.

Minimum	Maximum
3 A	I _{max}



5 Épaisseur de la pièce

Permet la sélection de l'épaisseur de la pièce à souder.

Permet le réglage de l'appareil grâce au réglage de la pièce à souder.

FR

6 Cordon d'angle "a"



Permet de régler la profondeur du cordon sur une soudure d'angle.

10 Pré-gaz



Cette touche permet de sélectionner et de régler l'arrivée du gaz avant l'amorçage de l'arc. Elle permet d'alimenter le gaz dans la torche et de préparer la soudure.

Minimum	Maximum	Réglage défaut	par
0/off	99.9 s	0.1 s	

11 Soft start



Cette touche permet de régler la vitesse d'avancement du fil durant les phases qui précèdent l'amorçage. Elle permet un amorçage à vitesse réduite, donc plus doux et avec moins de projections.

Minimum	Maximum	Réglage défaut	par
10 %	100 %	50 %	

12 Rampe moteur



Cette touche permet une transition graduelle entre la vitesse d'amorçage du fil et la vitesse du fil.

Minimum	Maximum	Réglage défaut	par
0/off	1.0 s	0/off	

15 Burn back



Cette touche permet de régler le temps de fusion du fil en l'empêchant de coller en fin de soudure. Elle permet de régler la longueur de l'extrémité du fil qui dépasse de la torche.

Minimum	Maximum	Réglage défaut	par
-2.00	+2.00	0/syn	

16 Post gaz



Il permet de régler l'arrivée du gaz en fin de soudage.

Minimum	Maximum	Réglage défaut	par
0/off	99.9 s	2.0 s	

19 Duty cycle (double pulsé)



Permet le réglage du duty cycle en mode double pulsé.

Minimum	Maximum	Réglage défaut	par
10 %	90 %	50 %	

20 Double pulsation



Permet le réglage de l'amplitude de pulsation.

Minimum	Maximum	Réglage défaut	par
0 %	100 %	±25 %	

Minimum	Maximum	Réglage défaut	par
0.5 m/min	22 m/min	2.5 m/min	

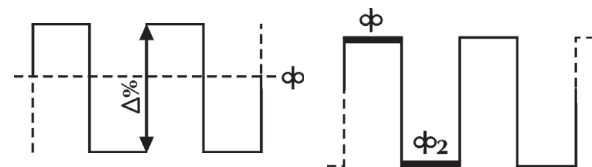

21 Fréquence de pulsation (double pulsé)



Permet le réglage du cycle, par ex. de la période de répétition de la pulsation.

Minimum	Maximum	Réglage défaut	par
0.1 Hz	5.0 Hz	2.0 Hz	

22 Tension secondaire (double pulsé)

Permet le réglage de la tension du niveau de pulsation secondaire.

Permet d'obtenir une plus grande stabilité de l'arc pendant les différentes phases de pulsation.

Minimum	Maximum	Réglage par défaut
-5.0	+5.0	0/syn

23 Rampes de pulsation (double pulsé)

Permet le réglage du temps de pente durant le mode de pulsation.

Minimum	Maximum	Réglage par défaut
1 %	100 %	50 %

24 Bilevel (4T - crater filler)

Il permet de régler la vitesse de fil secondaire dans le mode de soudage bilevel.

En appuyant sur la gachette et puis en la relâchant rapidement, " ϕ_2 " on passe au niveau.

Chaque fois qu'on répète cette opération on change le niveau du courant de " ϕ " et vice versa.

Minimum	Maximum	Réglage par défaut
1 %	200 %	0/off

25 Montée initiale

Permet le réglage de la valeur de vitesse de fil durant la première phase anti-cratère de soudage.

Permet d'augmenter l'énergie fournie à la pièce pendant la phase durant laquelle la matière, encore froide, nécessite plus de chaleur pour fondre uniformément.

Minimum	Maximum	Réglage par défaut
20 %	200 %	120 %

26 Evanouissement (anti-cratère)

Permet le réglage de la valeur de vitesse de fil pendant la phase de fin de soudage.

Permet de réduire l'énergie fournie à la pièce pendant la phase durant laquelle la matière est déjà très chaude, réduisant ainsi le risque de déformations inutiles.

Minimum	Maximum	Réglage par défaut
20 %	200 %	80 %

27 Temps d'incrément initial

Permet de régler le temps d'incrément initial.

Permet d'automatiser la fonction "anticratère".

Minimum	Maximum	Réglage par défaut
0.1 s	99.9 s	0/off

28 Temps d'anti-cratère

Permet de régler le temps "anti-cratère".

Permet d'automatiser la fonction "anticratère".

Minimum	Maximum	Réglage par défaut
0.1 s	99.9 s	0/off

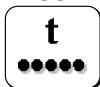
30 Soudage par point

Permet l'accès au mode « soudage par point » et le réglage de la durée du point.

Minimum	Maximum	Réglage par défaut
0.1 s	99.9 s	0/off

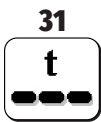

31 Point d'arrêt

Cette touche permet d'activer le mode "point d'arrêt" et de régler l'intervalle des points entre deux soudures.

Minimum	Maximum	Réglage défaut	par
0.1 s	99.9 s	0/off	



32 Tension secondaire (Bilevel MIG)

Permet le réglage de la tension du niveau de pulsation secondaire.

Permet d'obtenir une plus grande stabilité de l'arc pendant les différentes phases de pulsation.

Minimum	Maximum	Réglage défaut	par
-5.0	+5.0	0/syn	



33 Inductance secondaire (Bilevel MIG)

Permet le réglage de l'inductance du niveau de pulsation secondaire.

Permet d'obtenir un arc plus ou moins rapide pour compenser les mouvements du soudeur et l'instabilité naturelle de la soudure.

Inductance basse = arc réactif (plus de projections).

Inductance haute = arc moins réactif (moins de projections).

Minimum	Maximum	Réglage défaut	par
-30	+30	0/syn	



34 Rampe incrément initial

Permet de régler un passage progressif entre l'incrément initial et le soudage.

Minimum	Maximum	Réglage défaut	par
0 s	10 s	0/off	



35 Rampe crater filler

Permet de régler un passage progressif entre le soudage et le crater filler.

Minimum	Maximum	Réglage défaut	par
0 s	10 s	0/off	

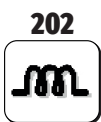

202 Inductance

Permet le réglage électronique de l'inductance de série du circuit de soudage.

Permet d'obtenir un arc plus ou moins rapide pour compenser les mouvements du soudeur et l'instabilité naturelle de la soudure.

Inductance basse = arc réactif (plus de projections).

Inductance haute = arc moins réactif (moins de projections).

Minimum	Maximum	Réglage défaut	par
-30	+30	0/syn	



331 Tension moyenne compensée

Permet de régler la tension de soudage.



398 Constante de référence de la vitesse de déplacement

Constante de référence pour tous les procédés de soudage

Valeur de la vitesse de déplacement de la torche à laquelle le système se réfère pour effectuer les calculs des paramètres de soudage



399 Vitesse de découpage

Permet de régler la vitesse de soudage.

Default cm/min: vitesse de référence en soudage manuel.

Syn: valeur sinergique.

Minimum	Maximum	Réglage défaut	par
syn min	syn max	35 cm/min	

500 Configuration de la machine

Permet la sélection de l'interface graphique exigée.
Permet l'accès aux niveaux les plus hauts du set-up (sélection).
Consulter le paragraphe "Personnalisation d'interface (Set up 500)"

Valor	Interface Utilisateur	Valor	Niveau sélectionné
XE	Mode Simple	USER	Utilisateur
XA	Mode Avancé	SERV	Service
XP	Mode Expert	vaBW	vaBW

551 Lock/unlock

Permet le blocage d'accès au panneau de commandes et la possibilité d'insérer un code de protection.
Consulter le paragraphe "Lock/unlock (Set up 551)".

552 Tonalité du vibreur sonore

Pour régler la tonalité du vibreur sonore.

Minimum	Maximum	Réglage par défaut
0/off	10	10

601 Réglage graduel

Permet le réglage graduel d'un paramètre qui peut être personnalisé par l'opérateur.
Fonctionnalité contrôlée par le bouton haut / bas de la torche.

Minimum	Maximum	Réglage par défaut
1	lmax	1

602 Paramètre externe CH1, CH2, CH3, CH4

Permet la gestion du paramètre externe 1, 2, 3, 4 (valeur minimum, valeur maximum, valeur par défaut, paramètre sélectionné).

Consulter le paragraphe "Gestion des commandes externes (Set up 602)".

606 Torche U/D

Permet la gestion du paramètre externe (U/D).

Valor	Réglage par défaut	Fonction de rappel
0/off	-	off
1/I1	X	Courant
	-	Rappel de programme

612 Réglage de la torche DgMig

Permet la gestion des canaux de la torche numérique.

Valor	Réglage par défaut	Fonction de rappel
0/off	-	off
1/I1	-	Courant
2/ 	-	Rappel de programme
3/CH3	-	CH3
4/CH4	-	CH4
5/STD	X	STD

653 Vitesse du fil

Permet le réglage de la vitesse d'avance de fil (au cours de l'étape de chargement).

Minimum	Maximum	Réglage par défaut
0.5 m/min	22.0 m/min	3.0 m/min

FR

FR

- 705 Calibration de résistance du circuit**
 Permet l'étalonnage du système.
 Consulter le paragraphe "Calibration de résistance du circuit (set up 705)".

- 751 Lecture du courant**
 Permet l'affichage de la valeur réelle du courant de soudage.

- 752 Lecture de la tension**
 Permet l'affichage de la valeur réelle de la tension de soudage.

- 755 Lecture du débit gaz**
 Permet l'affichage de la valeur réelle du débit gaz.

- 757 Lecture vitesse fil**
 Lecture encodeur moteur 1.

- 758 Vitesse du mouvement robot**
 Permet l'affichage de la vitesse du mouvement du bras d'un robot ou d'un dispositif d'automatisation.

- 760 Lecture du courant (moteur 1)**
 Permet l'affichage de la valeur réelle du courant (moteur 1).

- 768 Mesure de l'apport de chaleur HI**
 Permet de lire la valeur de la mesure de l'apport thermique en soudage.

- 770 Valeur du taux de dépôt**
 Permet d'afficher la valeur du taux de dépôt



- 801 Limites de sécurité**
 Permet la sélection des limites d'avertissement et de sécurité.
 Permet de contrôler le procédé de soudage en mettant des limites de sécurité et d'avertissement sur les principaux paramètres de soudage mesurables.
 Permet le contrôle précis des différentes phases de soudage.
 Consulter le paragraphe "Limites de sécurité (Set up 801)".



5.2 Procédures spécifiques d'utilisation des paramètres

5.2.1 Personnalisation de l'écran à 7 segments

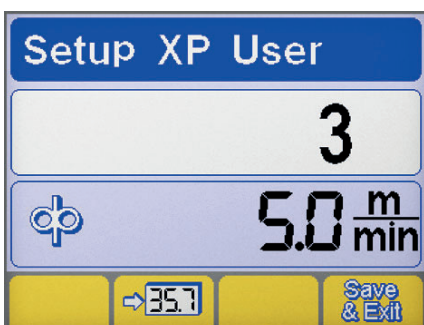
Permet d'afficher en permanence la valeur d'un paramètre sur l'écran à 7 segments.



- ▶ Entrer dans le menu de sélection (Set-up) par une pression d'au moins 5 secondes sur le bouton de réglage.
- ▶ Sélectionner le paramètre souhaité en tournant le potentiomètre.
- ▶ Enregistrer le paramètre sélectionné dans l'écran à 7 segments par une pression sur la touche **357**.
- ▶ Sauvegarder et sortir de l'écran en cours par une pression sur la touche **Save**.

5.2.2 Personnalisation d'interface (Set up 500)

Permet la personnalisation des paramètres sur le menu principal.

500 Configuration de la machine

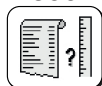

Permet la sélection de l'interface graphique exigée.

Valor	Interface Utilisateur
XE	Mode Simple
XA	Mode Avancé
XP	Mode Expert

MODE XE

MIG/MAG

Paramètres de soudage

Fonctions

MODE XA

MIG/MAG

Paramètres de soudage

Fonctions

MODE XP

MIG/MAG

Paramètres de soudage

Fonctions

5.2.3 Lock/unlock (Set up 551)

Permet le blocage d'accès au panneau de commandes et la possibilité d'insérer un code de protection.

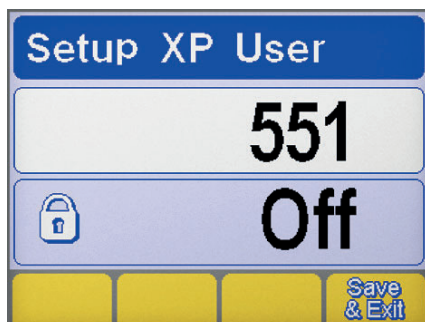

Sélection du paramètre

- ▶ Entrer dans le menu de sélection (Set-up) par une pression d'au moins 5 secondes sur le bouton de réglage.
- ▶ Sélectionner le paramètre désiré (551).
- ▶ Activer le réglage du paramètre sélectionné par une pression sur le bouton de réglage.

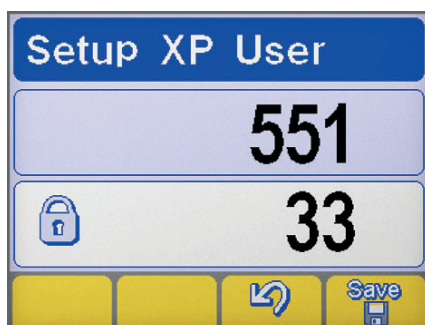

Réglage du mot de passe

- ▶ Sélectionner un code numérique (mot de passe) en tournant le potentiomètre.
- ▶ Confirmez l'opération en appuyant sur la touche de l'encodeur.
- ▶ Annuler l'opération par une pression sur la touche .
- ▶ Pour enregistrer la modification, appuyez sur la touche: .

FR

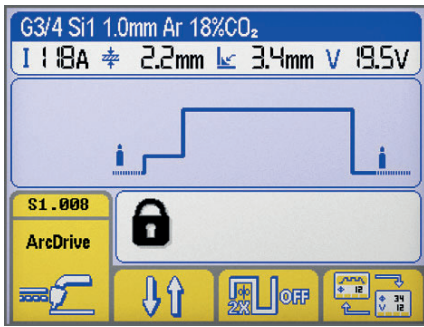

Fonctions du panneau

- ▶ Accéder temporairement (5 minutes) aux fonctionnalités du panneau en tournant le potentiomètre et en entrant le mot de passe correct.
- ▶ Confirmez l'opération en appuyant sur la touche de l'encodeur.
- ▶ Déverrouiller définitivement le panneau de commande en entrant dans le menu de sélection (Set-up) (suivre les instructions décrites ci-dessus) et ramener le paramètre 551 en position « off ».
- ▶ Confirmez l'opération en appuyant sur la touche de l'encodeur.
- ▶ Pour enregistrer la modification, appuyez sur la touche:

5.2.4 Gestion des commandes externes (Set up 602)

Permet la gestion du paramètre externe 2 (valeur minimum, valeur maximum, valeur par défaut, paramètre sélectionné).



Sélection du paramètre

- ▶ Entrer dans le menu de sélection (Set-up) par une pression d'au moins 5 secondes sur le bouton de réglage.
- ▶ Sélectionner le paramètre désiré (602).
- ▶ Entrer dans l'écran de « Gestion des commandes externes » par une pression sur le bouton de réglage.

Gestion des commandes externes

- ▶ Sélectionner la sortie de commande à distance RC désirée (CH1, CH2, CH3, CH4) par une pression sur la touche
- ▶ Sélectionner le paramètre souhaité (Min-Max-parametre) par une pression sur le bouton de réglage.
- ▶ Régler le paramètre souhaité (Min-Max-parametre) en tournant le potentiomètre.
- ▶ Pour enregistrer la modification, appuyez sur la touche:
- ▶ Annuler l'opération par une pression sur la touche

5.2.5 Calibration de résistance du circuit (set up 705)

Permet de calibrer le générateur sur la résistance du circuit de soudage actuel.

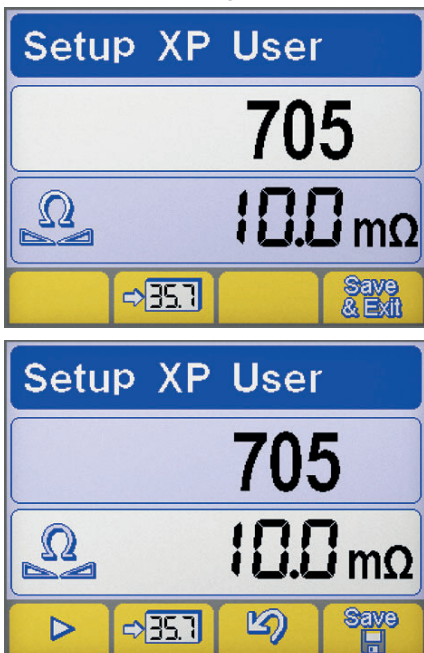

Sélection du paramètre

- ▶ Entrer dans le menu de sélection (Set-up) par une pression d'au moins 5 secondes sur le bouton de réglage.
- ▶ Sélectionner le paramètre désiré (705).
- ▶ Activer le réglage du paramètre sélectionné par une pression sur le bouton de réglage.
- ▶ Connectez le générateur au circuit de soudage (banc ou pièce).
- ▶ Retirez le capuchon pour exposer l'extrémité du porte-buse de la torche. (MIG/MAG)

Étalonnage

- ▶ Placer la buse guide fil en contact électrique avec la pièce à souder. (MIG/MAG)
- ▶ Appuyez sur la touche pour lancer la procédure.
- ▶ Maintenez le contact pendant au moins une seconde.
- ▶ La valeur affichée sur l'écran sera mise à jour après l'étalonnage.
- ▶ Confirmer l'opération par une pression sur la touche
- ▶ Annuler l'opération par une pression sur la touche
- ▶ Pour enregistrer la modification et quitter la configuration, appuyez sur la touche:

FR

5.2.6 Limites de sécurité (Set up 801)

Permet la sélection des limites d'avertissement et de sécurité.

Permet de contrôler le procédé de soudage en mettant des limites de sécurité et d'avertissement sur les principaux paramètres de soudage mesurables.

Permet le contrôle précis des différentes phases de soudage.

Consulter le paragraphe "Limites de sécurité (Set up 801)".

Seuil d'alerte		Limites de sécurité	
----------------	--	---------------------	--

<p> Courant de soudage</p> <p> Lecture du débit gaz</p> <p> Lecture du courant (moteur 1)</p> <p> Lecture du débit du liquide réfrigérant</p> <p> Lecture du température du liquide réfrigérant</p>	<p> Tension de soudage</p> <p> Vitesse du mouvement robot</p> <p> Lecture du courant (moteur 2)</p> <p> Lecture vitesse fil</p>
---	---

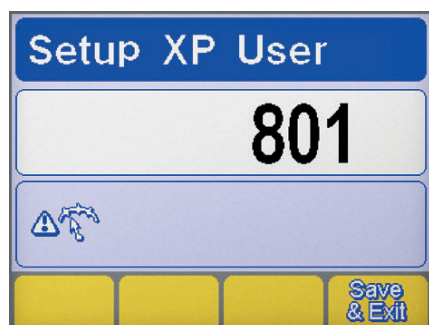
FR

Sélection du paramètre

- ▶ Entrer dans le menu de sélection (Set-up) par une pression d'au moins 5 secondes sur le bouton de réglage.
- ▶ Sélectionner le paramètre désiré (801).
- ▶ Entrer sur l'écran « Limites de sécurité » par une pression sur le bouton de réglage.

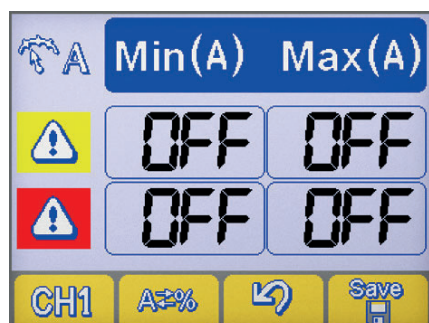

Sélection du paramètre

- ▶ Sélectionner le paramètre souhaité par une pression sur la touche **CH1**.
- ▶ Sélectionner le mode de sélection des limites de sécurité par une pression sur la touche **A=%**.

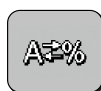

Configuration de la machine



Valeur absolue



Valeur en pourcentage

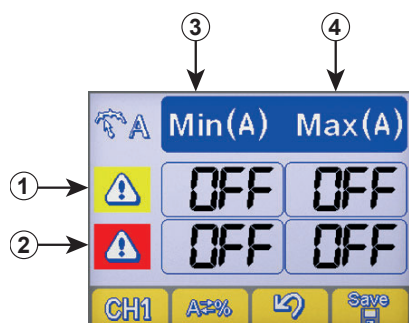

Configuration des seuils de protection

- ① Ligne de limite d'avertissement
- ② Ligne de limites d'alarmes
- ③ Colonne de niveaux minimums
- ④ Colonne de niveaux maximums

- ▶ Sélectionner la case souhaitée par une pression sur le bouton de réglage (la case sélectionnée apparaît en surbrillance).
- ▶ Régler le niveau de la limite sélectionnée en tournant le potentiomètre.
- ▶ Pour enregistrer la modification, appuyez sur la touche:



Dépasser une des limites d'avertissement déclenche un signal visuel sur le panneau de commandes.



Dépasser une des limites d'alarme déclenche un signal visuel sur le panneau de commandes et le blocage immédiat des opérations de soudage.



Il est possible de mettre des filtres de début et de fin de soudure afin d'éviter des messages d'erreur durant l'amorçage et l'extinction de l'arc (consulter le paragraphe « Set up » - Paramètres 802-803-804).

6. ACCESSOIRES

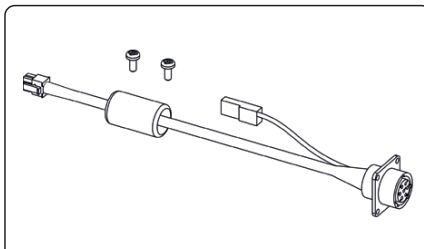

Kit RC (WF... Steeldrive)
73.11.015

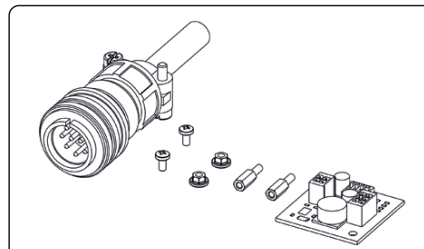

Kit Push-Pull
73.11.012

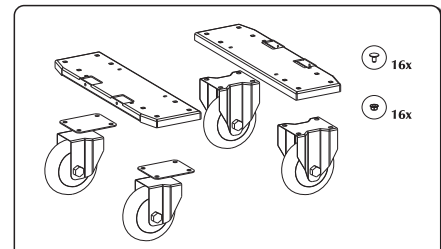

Kit roulettes grandes devidoir
73.10.073

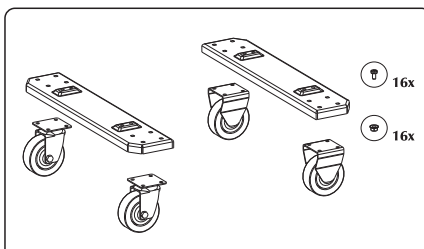

Kit petites roulettes devidoir
73.10.074

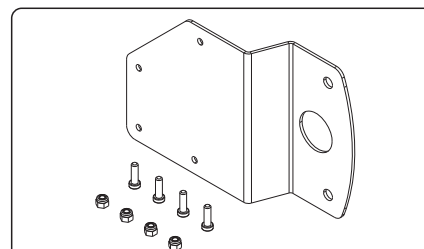

Kit support devidoir
73.10.075

*Assemblage en usine

Consulter le paragraphe "Installation kit/accessoires".

7. ENTRETIEN



Effectuer l'entretien courant de l'installation selon les indications du constructeur. Toutes les portes d'accès et de service et les couvercles doivent être fermés et bien fixés lorsque l'appareil est en marche. L'installation ne doit absolument pas être modifiée. Eviter l'accumulation de poussière métallique à proximité et sur les grilles d'aération.



Toute opération éventuelle de maintenance doit exclusivement être effectuée par du personnel qualifié. La réparation ou le remplacement de pièces de la part de personnel non autorisé implique l'annulation immédiate de la garantie du produit. La réparation ou le remplacement de pièces doit exclusivement être effectué par du personnel technique qualifié.



Couper l'alimentation électrique de l'installation avant toute intervention!

7.1 Contrôles périodiques sur le générateur



Effectuer le nettoyage interne avec de l'air comprimé à basse pression et des brosses souples. Contrôler les connexions électriques et tous les câbles de branchement.

7.2 Responsabilité























































Le constructeur décline toute responsabilité si l'opérateur ne respecte pas ces instructions. Le constructeur décline toute responsabilité si l'opérateur ne respecte pas ces instructions. En cas de doute et/ou de problème, n'hésitez pas à consulter le dépanneur agréé le plus proche.

8. CODES D'ALARMES

ALARME
 L'intervention d'une alarme ou le dépassement d'un seuil critique de protection entraîne une signalisation visuelle sur le panneau de commande et le blocage immédiat des opérations de soudage.

ATTENTION
 Le dépassement d'un seuil de protection entraîne une signalisation visuelle sur le panneau de commande, mais permet de poursuivre les opérations de soudage.

Ci-dessous figure la liste de toutes les alarmes et de tous les seuils critiques de protection du système.

 E01	Surtempérature		 E02	Surtempérature	
 E05	Surintensité		 E07	Défaut du système d'alimentation du moteur du dévidoir	
 E08	Moteur bloqué		 E10	Surintensité du module de puissance (Inverter)	
 E12.1	Erreur de communication WF1		 E13	Erreur de communication (FP)	
 E14.xx	Programme non valide le sous-code de l'erreur indique le numéro du job supprimé		 E15	Programme non valide	
 E16.1	Erreur de communication RI 1000/2000/3000 (CAN bus)		 E16.2	Erreur de communication RI 3000 (Modbus)	
 E16.3	Erreur de communication RI 1000/2000		 E18.xx	Programme non valide le sous-code de l'erreur indique le numéro du job supprimé	
 E19	Erreur de configuration du système		 E19.1	Erreur de configuration du système	
 E19.11	Erreur de configuration du système (WF)		 E20	Mémoire défectueuse	
 E21	Perte de données		 E23	Programmes de soudage non présents	
 E27	Mémoire défectueuse (RTC)		 E32	Perte de données	
 E33.1	Erreur de configuration du système (LCD 3.5")		 E33.3	Erreur de communication (ACTIVATION KEY)	
 E33.4	Erreur de communication (ACTIVATION KEY)		 E40	Défaut d'alimentation du système	
 E43	Liquide de refroidissement manquant		 E44	Gaz manquant	

E48	Fil manquant (Automatisation et robotique)		E50	Fil collé (Automatisation et robotique)	
E54	Niveau de courant dépassé (Limite inférieure)		E55	Niveau de courant dépassé (Limite supérieure)	
E56	Niveau de tension dépassé (Limite inférieure)		E57	Niveau de tension dépassé (Limite supérieure)	
E58	Niveau de flux de gaz dépassé (Limite inférieure)		E59	Niveau de flux de gaz dépassé (Limite supérieure)	
E62	Niveau de courant dépassé (Limite inférieure)		E63	Niveau de courant dépassé (Limite supérieure)	
E64	Niveau de tension dépassé (Limite inférieure)		E65	Niveau de tension dépassé (Limite supérieure)	
E66	Niveau de flux de gaz dépassé (Limite inférieure)		E67	Niveau de flux de gaz dépassé (Limite supérieure)	
E71	Surchauffe liquide de refroidissement		E74	Niveau de courant moteur 1 dépassé	
E76	Niveau de débit du liquide de refroidissement dépassé		E77	Niveau de température du liquide de refroidissement	
E80	Fil manquant (wire end)		E81	Surintensité (pompe WU)	
E82	Erreur de communication (WU)		E83	Pompe bloquée	
E99.2	Alarme système de configuration (inverter)		E99.3	Alarme système de configuration (FP)	
E99.4	Alarme système de configuration (FP)		E99.5	Alarme système de configuration (FP)	
E99.6	Alarme système de configuration		E99.11	Mémoire défectueuse	

9. DIAGNOSTIC ET SOLUTIONS

Dévidage du fil bloqué

Cause

- » Gâchette de torche défectueux.
- » Galets non adaptés ou usés.

Solution

- » Remplacer le composant endommagé.
- » S'adresser service après-vente le plus proche pour la réparation de l'installation.
- » Remplacer les galets.

» Moto réducteur défectueux.	» Remplacer le composant endommagé. » S'adresser service après-vente le plus proche pour la réparation de l'installation.
» Gaine de la torche endommagée.	» Remplacer le composant endommagé. » S'adresser service après-vente le plus proche pour la réparation de l'installation.
» Dévidoir non alimenté	» Vérifier la connexion au générateur. » Consulter le paragraphe "Raccordement". » S'adresser service après-vente le plus proche pour la réparation de l'installation.
» Enroulement du fil sur la bobine irrégulier.	» Réajuster le fil ou remplacer la bobine.
» Buse de la torche a fondu (le fil colle)	» Remplacer le composant endommagé.

Dévidage du fil irrégulier

Cause	Solution
» Gâchette de torche défectueux.	» Remplacer le composant endommagé. » S'adresser service après-vente le plus proche pour la réparation de l'installation.
» Galets non adaptés ou usés.	» Remplacer les galets.
» Moto réducteur défectueux.	» Remplacer le composant endommagé. » S'adresser service après-vente le plus proche pour la réparation de l'installation.
» Gaine de la torche endommagée.	» Remplacer le composant endommagé. » S'adresser service après-vente le plus proche pour la réparation de l'installation.
» Embrayage d'axe dur ou dispositifs de blocage des galets mal réglés.	» Desserrer levier de frein. » Augmenter la pression sur les galets.

Inclusions de scories

Cause	Solution
» Encrassage.	» Effectuer un nettoyage des pièces avant d'effectuer le soudage.
» Diamètre de l'électrode trop gros.	» Utiliser une électrode de diamètre inférieur.
» Préparation incorrecte des bords.	» Augmenter le chanfrein.
» Mode de soudage incorrect.	» Réduire la distance entre l'électrode et la pièce. » Avancer régulièrement pendant toutes les phases de soudage.

Soufflures

Cause	Solution
» Gaz de protection insuffisant.	» Régler le débit de gaz. » Vérifier le bon état de la buse et du diffuseur gaz de la torche.

Collages

Cause	Solution
» Longueur de l'arc incorrecte.	» Augmenter la distance entre l'électrode et la pièce. » Augmenter la tension de soudage.
» Paramètres de soudage incorrects.	» Augmenter l'intensité de soudage. » Augmenter la tension de soudage.
» Mode de soudage incorrect.	» Augmenter l'inclinaison de la torche.
» Dimension des pièces à souder trop importante.	» Augmenter l'intensité de soudage. » Augmenter la tension de soudage.
» Dynamique d'arc incorrecte.	» Changer la masse de place sur une valeur supérieure.

Effondrement du métal

Cause	Solution
» Paramètres de soudage incorrects.	» Réduire la tension de soudage.
» Longueur de l'arc incorrecte.	» Réduire la distance entre l'électrode et la pièce. » Réduire la tension de soudage.
» Mode de soudage incorrect.	» Réduire la vitesse d'oscillation latérale de remplissage. » Réduire la vitesse de progression du soudage.
» Gaz de protection insuffisant.	» Utiliser des gaz adaptés aux matériaux à souder.

Oxydations

Cause	Solution
» Gaz de protection insuffisant.	» Régler le débit de gaz. » Vérifier le bon état de la buse et du diffuseur gaz de la torche.

Porosité

Cause	Solution
» Présence de graisse, de peinture, de rouille ou de saleté sur les pièces à souder.	» Effectuer un nettoyage des pièces avant d'effectuer le soudage.
» Présence de graisse, de peinture, de rouille ou de saleté sur métal d'apport.	» Toujours utiliser des produits et des matériaux de qualité. » Toujours conserver le d'apport en parfaites conditions.
» Présence d'humidité dans le métal d'apport.	» Toujours utiliser des produits et des matériaux de qualité. » Toujours conserver le d'apport en parfaites conditions.
» Longueur de l'arc incorrecte.	» Réduire la distance entre l'électrode et la pièce. » Réduire la tension de soudage.
» Présence d'humidité dans le gaz de soudage.	» Toujours utiliser des produits et des matériaux de qualité. » Veiller à maintenir l'installation d'alimentation du gaz en parfaites conditions.
» Gaz de protection insuffisant.	» Régler le débit de gaz. » Vérifier le bon état de la buse et du diffuseur gaz de la torche.
» Solidification du bain de soudure trop rapide.	» Réduire la vitesse de progression du soudage. » Préchauffer les pièces à souder. » Augmenter l'intensité de soudage.

Faissures chaudes

Cause	Solution
» Paramètres de soudage incorrects.	» Réduire la tension de soudage.
» Présence de graisse, de peinture, de rouille ou de saleté sur les pièces à souder.	» Effectuer un nettoyage des pièces avant d'effectuer le soudage.
» Présence de graisse, de peinture, de rouille ou de saleté sur métal d'apport.	» Toujours utiliser des produits et des matériaux de qualité. » Toujours conserver le d'apport en parfaites conditions.
» Mode de soudage incorrect.	» Suivre les étapes correctes pour le type de joint à souder.
» Pièces à souder présentant des caractéristiques différentes.	» Effectuer un beurrage avant de procéder au soudage.

Faissures froides

Cause	Solution
» Présence d'humidité dans le métal d'apport.	» Toujours utiliser des produits et des matériaux de qualité. » Toujours conserver le d'apport en parfaites conditions.
» Géométrie spéciale du joint à souder.	» Préchauffer les pièces à souder. » Effectuer un post-chauffage. » Suivre les étapes correctes pour le type de joint à souder.

10. MODE D'EMPLOI

10.1 Soudage en continu (MIG/MAG)

Introduction

Un système MIG est formé d'un générateur à courant continu, d'un dévidoir de fil, d'une bobine de fil, d'une torche et de gaz.

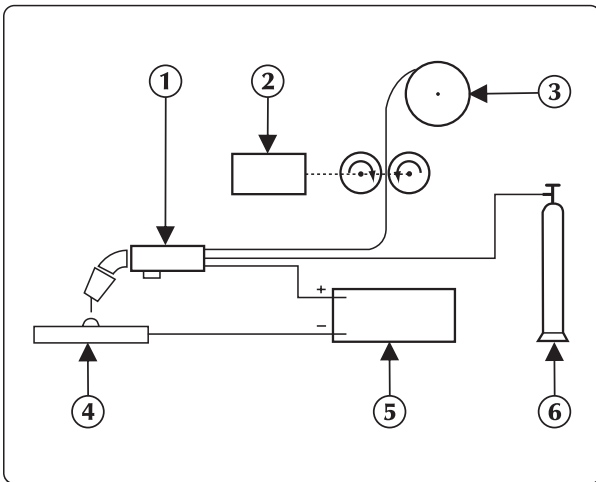

Installation de soudage MIG manuel

Le courant est transféré à l'arc par l'électrode fusible (câble placé sur la polarité positive);

Le métal fondu est déposé sur la pièce à souder à travers.

L'alimentation du fil est nécessaire pour remplacer le fil d'apport fondu durant la soudure.

1. Torche
2. Dévidoir
3. Fil de soudage
4. Pièce à souder
5. Générateur
6. Bouteille de gaz

Méthodes adoptées

Pour la soudure sous protection de gaz, la façon dont les gouttes se détachent de l'électrode permet d'avoir deux systèmes de transfert.

La première méthode appelée "TRANSFERT PAR COURTS-CIRCUITS (SHORT-ARC)" met l'électrode directement en contact avec le bain. Il se produit donc un court-circuit qui fond le fil qui s'interrompt, l'arc se rallume ensuite et le cycle se répète.

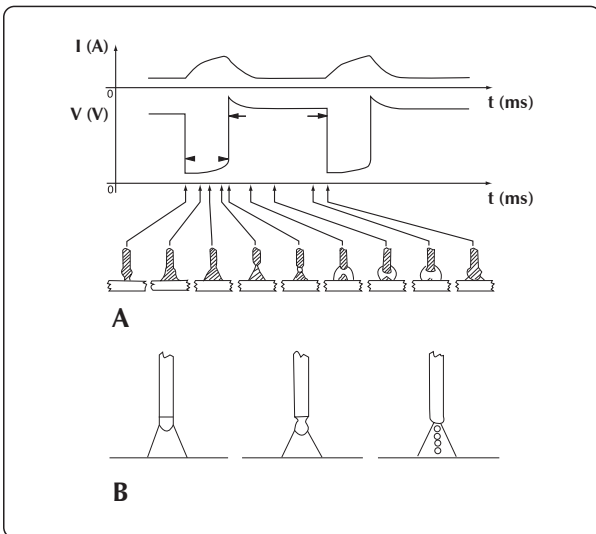

Régime ARC COURT (short arc) et régime ARC LONG/ PULVERISATION AXIALE (spray arc)

Une autre méthode pour obtenir le transfert des gouttes est celle appelée "TRANSFERT PAR PULVERISATION AXIALE (SPRAY-ARC)". Elle permet aux gouttes de se détacher de l'électrode et de tomber dans le bain de fusion en un deuxième temps.

Paramètres de soudage

La visibilité de l'arc évite à l'opérateur de suivre strictement les panneaux de réglage, ce qui lui permet de contrôler le bain de fusion.

- La tension influe directement sur l'aspect du cordon, mais la taille du cordon peut être modifiée en fonction des exigences en agissant manuellement sur le mouvement de la torche afin d'obtenir des dépôts variables avec une tension constante.
- La vitesse d'avancement du fil dépend de l'intensité de soudage.

Les deux figures suivantes montrent les relations qui existent entre les différents paramètres de soudage.

FR



Tableau permettant de choisir les paramètres de soudage en fonction des applications les plus classiques et des fils utilisés couramment

Tension de l'arc	Ø 0,8 mm	Ø 1,0-1,2 mm	Ø 1,6 mm	Ø 2,4 mm
16V - 22V SHORT - ARC	 60 - 160 A Faible pénétration pour des fines épaisseurs	 100 - 175 A Bon contrôle de la pénétration et de la fusion	 120 - 180 A Bonne fusion à plat et verticale	 150 - 200 A Non utilisé
24V - 28V REGIME GLOBULAIRE (Zone de transition)	 150 - 250 A Soudure automatique d'angle	 200 - 300 A Soudure automatique avec une tension élevée	 250 - 350 A Soudure automatique descendante	 300 - 400 A Non utilisé
30V - 45V SPRAY - ARC	 150 - 250 A Faible pénétration avec réglage à 200 A	 200 - 350 A Soudure automatique a plusieurs passes	 300 - 500 A Bonne pénétration avec une soudure descendante	 500 - 750 A Bonne pénétration avec beaucoup de dépôt sur de grosses épaisseurs

Unalloyed steel

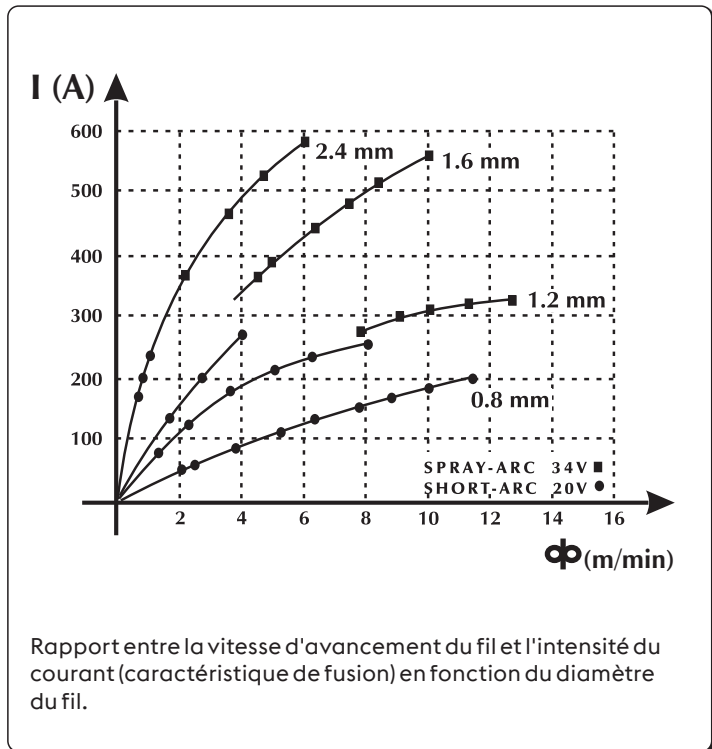
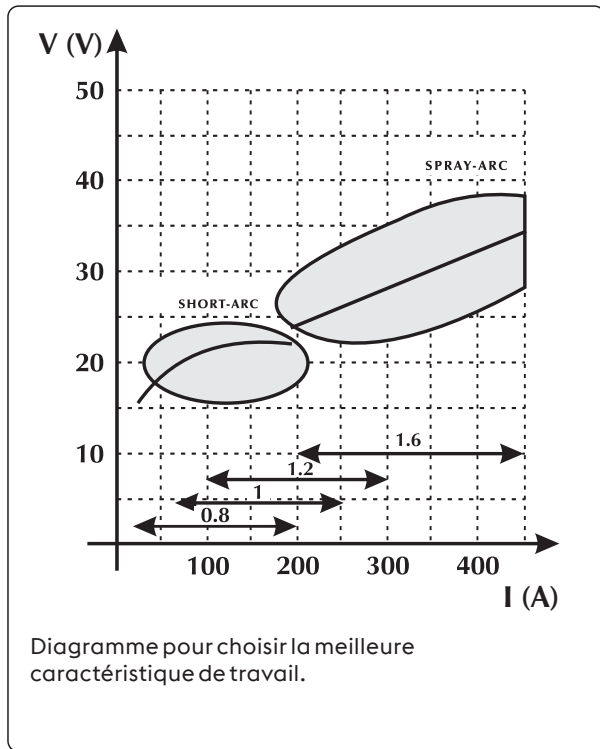
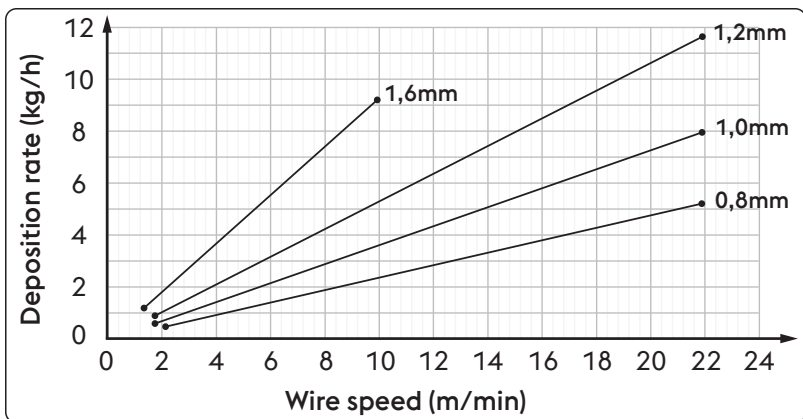

Ø	Wire speed	Deposition rate
0,8 mm	2,0 m/min	0,5 kg/h
	22,0 m/min	5,3 kg/h
1,0 mm	1,6 m/min	0,6 kg/h
	22,0 m/min	8,1 kg/h
1,2 mm	1,6 m/min	0,9 kg/h
	22,0 m/min	11,7 kg/h
1,6 mm	1,2 m/min	1,1 kg/h
	10,0 m/min	9,4 kg/h

High alloyed steel

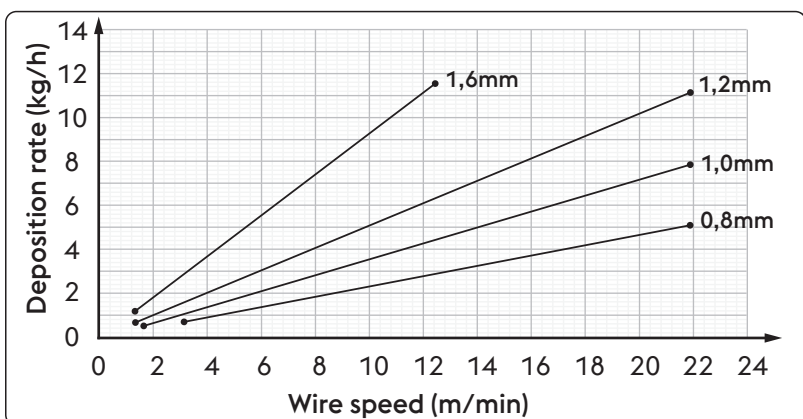

Ø	Wire speed	Deposition rate
0,8 mm	2,0 m/min	0,5 kg/h
	22,0 m/min	5,3 kg/h
1,0 mm	1,6 m/min	0,6 kg/h
	22,0 m/min	8,1 kg/h
1,2 mm	1,6 m/min	0,9 kg/h
	22,0 m/min	11,7 kg/h
1,6 mm	1,2 m/min	1,1 kg/h
	10,0 m/min	9,4 kg/h

Aluminum alloy

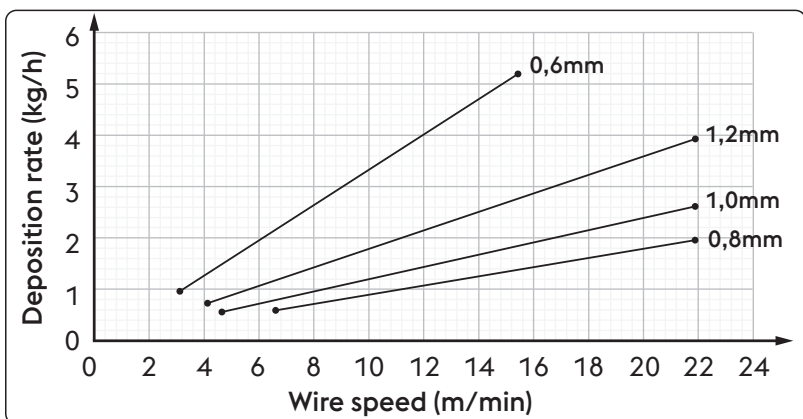

Ø	Wire speed	Deposition rate
0,8 mm	6,5 m/min	0,6 kg/h
	22,0 m/min	2,0 kg/h
1,0 mm	4,5 m/min	0,5 kg/h
	22,0 m/min	2,6 kg/h
1,2 mm	4,0 m/min	0,7 kg/h
	22,0 m/min	4,0 kg/h
1,6 mm	3,0 m/min	0,9 kg/h
	15,5 m/min	5,2 kg/h

FR

Gaz utilisables

La soudure MIG-MAG se caractérise surtout par le type de gaz utilisé, inerte pour la soudure MIG (Metal Inert Gas) et actif pour la soudure MAG (Metal Active Gas).

- Dioxyde de carbone (CO₂)

En utilisant le CO₂ comme gaz de protection, on obtient une pénétration optimale avec une grande vitesse d'avancement et de bonnes propriétés mécaniques, en ayant peu de frais. L'emploi de ce gaz donne malgré tout de gros problèmes sur la composition chimique finale des joints car il y a une perte d'éléments facilement oxydables et, en même temps, une augmentation de carbone dans le bain.

La soudure avec du CO₂ pur donne également d'autres types de problèmes tels que la présence excessive de projections et la formation de porosités dues au monoxyde de carbone.

- Argon

Ce gaz inerte est utilisé pour souder des alliages légers mais il est préférable d'ajouter un pourcentage de 2% d'oxygène et de CO₂ pour souder l'acier inoxydable au chrome-nickel, ce qui contribue à la stabilité de l'arc et à améliorer la forme du cordon.

- Hélium

Utilisé à la place de l'argon, ce gaz permet davantage de pénétration (sur de grosses épaisseurs) et augmente la vitesse d'avancement.

- Mélange Argon-Hélium

Il permet d'obtenir un arc plus stable par rapport à l'hélium pur, davantage de pénétration et de vitesse par rapport à l'argon.

- Mélange Argon- CO₂ et Argon- CO₂-Oxygène

Ce type de mélange est utilisé pour souder des matériaux ferreux, surtout dans des conditions d'ARC COURT (short arc), car il améliore l'apport thermique spécifique.

On peut néanmoins l'utiliser également dans des conditions d'ARC LONG/PULVERISATION AXIALE (spray arc).

Le mélange contient normalement un pourcentage entre 8% et 20% de CO₂ et environ 5% de O₂.

Consulter le manuel d'instructions du générateur.

Unalloyed steel / High alloyed steel		Aluminum alloy	
Gamme de courant	Débit gaz	Gamme de courant	Débit gaz
3-50 A	10-12 l/min	3-50 A	10-12 l/min
30-100 A	10-14 l/min	30-100 A	10-15 l/min
75-150 A	12-16 l/min	75-150 A	12-18 l/min
150-250 A	14-18 l/min	150-250 A	14-22 l/min
250-400 A	16-20 l/min	250-400 A	16-25 l/min
400-500 A	18-22 l/min	400-500 A	18-30 l/min

11. CARACTÉRISTIQUES TECHNIQUES

Caractéristiques du dévidoir WF NX 430 SteelDrive		U.M.
Type de motoréducteur	SL4R-4T	
Puissance du moto réducteur	120	W
Nombre de galets	4	
Diamètre de fil / Galet standard	1.0-1.2	mm
Diamètre des fils pouvant être utilisés/Galets moteurs	Vitesse d'avance de fil 0.8-1.6 fil aluminium 1.2-2.4 fil fourré	mm/Matériel
Bouton de purge du gaz	oui	
Bouton de dévidage du filv	oui	
Bouton poussoir de retour de fil	non	
Vitesse du fil	25 Ø 0.8 - 1.0	m/min
Synergies	oui	
Dispositifs externes	oui (optionnel)	
Prise pour torche Push-Pull	oui (optionnel)	
Diamètre de la bobine	200/300	mm
Diamètre des roulettes avant	63/125 (optional)	mm
Diamètre des roulettes arrière	63/125 (optional)	mm
Caractéristiques électriques WF NX 430 SteelDrive		U.M.
Tension d'alimentation U1	48	Vdc
Communication bus	DIGITAL	
Courant maximum absorbé I1max	4.5	A
Facteur d'utilisation WF NX 430 SteelDrive		U.M.
Facteur d'utilisation (40°C)		
(X=50%)	500	A
(X=60%)	470	A
(X=100%)	420	A
Facteur d'utilisation (25°C)		
(X=80%)	500	A
(X=100%)	470	A
Caractéristiques physiques WF NX 430 SteelDrive		U.M.
Degré de protection IP	IP23S	
Dimensions (lxdxh)	640x250x460	mm
Poids	19.0	Kg
Normes de construction	EN IEC 60974-5:2019 EN 60974-10/A1:2015	

12. PLAQUE DONNÉES

VOESTALPINE BÖHLER WELDING SELCO S.R.L. Via Palladio, 19 - ONARA (PADOVA) - ITALY			
WF NX 430		N°	
EN 60974-5:2019 IEC 60974-10/A1:2015 Class A			
	X (40°C)	60%	100%
	I₂	500A	400A
	U₁ 48V	I_{1max} 4.5A	
IP 23 S			
MADE IN ITALY			

FR

13. SIGNIFICATION DE LA PLAQUE DES DONNÉES

1		2	
3		4	
5			
	6	6A	6B
	7	7A	7B
8	9	10	
11			
MADE IN ITALY			

- 1 Marque de fabrique
- 2 Nom et adresse du constructeur
- 3 Modèle de l'appareil
- 4 N° de série
- X **XX**XXXXXXXXXX Année de fabrication
- 5 Référence aux normes de construction
- 6 Symbole du cycle d'intermittence
- 7 Symbole du courant nominal de soudage
- 6A Valeurs du cycle d'intermittence
- 6B Valeurs du cycle d'intermittence
- 7A Valeurs du courant nominal de soudage
- 7B Valeurs du courant nominal de soudage
- 8 Symbole pour l'alimentation
- 9 Tension nominale d'alimentation
- 10 Courant maximum nominal d'alimentation
- 11 Degré de protection

CE Déclaration de conformité UE
 EAC Déclaration de conformité EAC
 UKCA Déclaration de conformité UKCA

DECLARACIÓN UE DE CONFORMIDAD

El constructor

voestalpine Böhler Welding Selco S.r.l. - Via Palladio, 19 - 35019 Onara di Tombolo (PD) - ITALY
Tel. +39 049 9413/111 - Fax +39 049 9413/311 - www.voestalpine.com/welding

declara bajo su exclusiva responsabilidad que el siguiente producto:

WF NX 430 STEELDRIVE

71.01.083

es conforme a las directivas EU:

2014/35/EU LOW VOLTAGE DIRECTIVE

2014/30/EU EMC DIRECTIVE

2011/65/EU RoHS DIRECTIVE

y que se han aplicado las siguientes normas armonizadas:

EN IEC 60974-5:2019

WIRE FEEDERS

EN 60974-10/A1:2015

ELECTROMAGNETIC COMPATIBILITY REQUIREMENTS

La documentación que acredite el cumplimiento de las directivas se mantendrá disponible para inspecciones en el mencionado fabricante.

Toda reparación, o modificación, no autorizada por voestalpine Böhler Welding Selco S.r.l. hará decaer la validez e invalidará esta declaración.

Onara di Tombolo, 03/07/2023

voestalpine Böhler Welding Selco s.r.l.

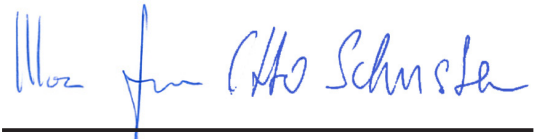

Mirco Frasson

Otto Schuster

Managing Directors

INDICE

1. ADVERTENCIA	157
1.1 Entorno de utilización	157
1.2 Protección personal y de terceros	157
1.3 Protección contra los humos y gases	158
1.4 Prevención contra incendios/explosiones	158
1.5 Prevención durante el uso de las botellas de gas	159
1.6 Protección contra descargas eléctricas	159
1.7 Campos electromagnéticos y interferencias	159
1.8 Grado de protección IP	160
1.9 Eliminación	160
2. INSTALACIÓN	160
2.1 Elevación, transporte y descarga	161
2.2 Colocación del equipo	161
2.3 Conexión	161
2.4 Instalación	161
3. PRESENTACIÓN DEL SISTEMA	163
3.1 Panel posterior	163
3.2 Panel de las tomas	163
3.3 Panel de mandos frontal	164
4. UTILIZACIÓN DEL EQUIPO	165
4.1 Pantalla de inicio	165
4.2 Pantalla de test	165
4.3 Pantalla principal	165
5. CONFIGURACIÓN	169
5.1 Configuración y ajuste de los parámetros	169
5.2 Procedimientos específicos de uso de los parámetros	178
6. ACCESORIOS	181
7. MANTENIMIENTO	182
7.1 Controles periódicos de la fuente de alimentación	182
7.2 Responsabilidad	182
8. CODIFICACIÓN DE ALARMAS	182
9. DIAGNÓSTICO Y SOLUCIÓN DE PROBLEMAS	184
10. INSTRUCCIONES DE USO	186
10.1 Soldadura con alambre continuo (MIG/MAG)	186
11. CARACTERÍSTICAS TÉCNICAS	191
12. ETIQUETA DE DATOS	192
13. SIGNIFICADO DE LA ETIQUETA DE LOS DATOS	192
14. ESQUEMA	459
15. CONECTORES	460
16. LISTA DE REPUESTOS	461
17. INSTALACIÓN KIT/ACCESORIOS	464

SÍMBOLOS



Peligros inminentes que causan lesiones graves y comportamientos peligrosos que podrían causar lesiones graves.



Comportamientos que podrían causar lesiones no leves, o daños a las cosas.



Las notas anteceditas precedidas de este símbolo son de carácter técnico y facilitan las operaciones.

1. ADVERTENCIA



Antes de comenzar cualquier tipo de operación, tiene que haber comprendido el contenido del presente manual. No efectúe modificaciones ni mantenimientos no descritos en este manual. El fabricante no es responsable por daños a personas o cosas causados por una lectura, o una puesta en aplicación negligente de cuanto escrito del contenido de este manual.

El manual de instrucciones debe permanecer guardado en el lugar de empleo del equipo. Complementariamente al manual de instrucciones, se deben tener en cuenta las reglas válidas a modo general, así como las reglas locales respecto a la prevención de accidentes y la protección medioambiental.



Todas las personas implicadas en la puesta en servicio, el manejo, el mantenimiento y la conservación del equipo deben:

- poseer la cualificación correspondiente
- Poseer conocimientos de soldadura
- Leer completamente y seguir escrupulosamente este manual de instrucciones

En caso de dudas o problemas sobre la utilización del equipo, aunque no se indiquen aquí, consulte con personal cualificado.

1.1 Entorno de utilización



El equipo debe utilizarse exclusivamente para las operaciones para las cuales ha sido diseñado, en los modos y dentro de los campos previstos en la placa de identificación y/o en este manual, según las directivas nacionales e internacionales sobre la seguridad. Un uso diferente del declarado por el fabricante se considera inadecuado y peligroso; en dicho caso, el fabricante no asumirá ninguna responsabilidad.



Este equipo tiene que debe utilizarse sólo para fines profesionales en un local industrial. El fabricante no responde de daños provocados por un uso del equipo en entornos domésticos.



El equipo debe utilizarse en locales con una temperatura comprendida entre -10°C y +40°C (entre +14°F y +104°F). El equipo debe transportarse y almacenarse en locales con una temperatura comprendida entre -25°C y +55°C (entre -13°F y 131°F).

El equipo debe utilizarse en locales sin polvo, ácidos, gases ni otras sustancias corrosivas.

El equipo debe utilizarse en locales con una humedad relativa no superior al 50% a 40°C (104°F).

El equipo debe utilizarse en locales con una humedad relativa no superior al 90% a 20°C (68°F).

El equipo debe utilizarse a una altitud máxima sobre el nivel del mar de 2000 m (6500 pies).



No utilizar dicho aparato para descongelar tubos.

No utilice el equipo para cargar baterías ni acumuladores.

No utilice el equipo para hacer arrancar motores.

1.2 Protección personal y de terceros



El proceso de soldadura es una fuente nociva de radiaciones, ruido, calor y emanaciones gaseosas. Coloque una pared divisoria ignífuga para proteger la zona de soldadura de los rayos, chispas y escorias incandescentes. Advierta a las demás personas que se protejan de los rayos del arco, o del metal incandescente y que no los fijamente.



Póngase prendas de protección para proteger la piel de los rayos del arco y de las chispas, o del metal incandescente. La indumentaria utilizada debe cubrir todo el cuerpo y debe ser:

- íntegra y en buenas condiciones
- ignífuga
- aislante y seca
- ceñida al cuerpo y sin dobleces



Utilice siempre zapatos resistentes y herméticos al agua.

Utilice siempre guantes que garanticen el aislamiento eléctrico y térmico.



Use máscaras con protecciones laterales para la cara y filtro de protección adecuado para los ojos (al menos NR10 o mayor).



Utilice siempre gafas de seguridad con aletas laterales, especialmente cuando tenga que deba retirar manual o mecánicamente las escorias de soldadura.



¡No use lentes de contacto!

ES



Use auriculares si el proceso de soldadura es muy ruidoso. Si el nivel de ruido supera los límites indicados por la ley, delimite la zona de trabajo y cerciórese de que las personas que entren en la misma estén protegidas con auriculares.



Mantenga siempre las tapas laterales cerradas durante los trabajos de soldadura. El equipo no debe ser modificado. Evite el contacto entre manos, cabellos, ropas, herramientas, etc. y piezas móviles, a saber: ventiladores, ruedas dentadas, rodillos y ejes, bobinas de hilo. No trabaje sobre las ruedas dentadas cuando el alimentador de alambre está funcionando. La desactivación de los dispositivos de protección en las unidades de avance del alambre es muy peligrosa y el fabricante no asumirá ninguna responsabilidad por los daños provocados a personas y bienes.



Mantenga la cabeza lejos de la antorcha mig/mag durante la carga y el avance del alambre. El alambre que sale puede provocar lesiones graves en las manos, el rostro y los ojos.



No toque las piezas recién soldadas, el calor excesivo podría provocar graves quemaduras. Tome todas las medidas de precaución anteriores incluso durante los trabajos de post-soldadura, puesto que de las piezas que se están enfriando podrían saltar escorias.



Compruebe que la antorcha se haya enfriado antes de efectuar trabajos o mantenimientos.



Compruebe que el grupo de refrigeración esté apagado antes de desconectar los tubos de suministro y de retorno del líquido refrigerante. El líquido caliente que sale podría provocar graves quemaduras.



Tenga a mano un equipo de primeros auxilios. No subestime quemaduras o heridas.



Antes de abandonar el puesto de trabajo, tome todas las medidas de seguridad para dejar la zona de trabajo segura y así impedir accidentes graves a personas o bienes.

1.3 Protección contra los humos y gases



Los humos, gases y polvos producidos por la soldadura pueden ser perjudiciales para la salud. El humo producido durante la soldadura en determinadas circunstancias, puede provocar cáncer o daños al feto en las mujeres embarazadas.

- Mantenga la cabeza lejos de los gases y del humo de soldadura.
- Proporcione una ventilación adecuada, natural o forzada, en la zona de trabajo.
- En el caso de ventilación insuficiente, utilice mascarillas con respiradores.
- En el caso de soldaduras en lugares angostos, se aconseja que una persona controle al operador desde el exterior.
- No use oxígeno para la ventilación.
- Compruebe la eficacia de la aspiración, comparando periódicamente las emisiones de gases nocivos con los valores admitidos por las normas de seguridad.
- La cantidad y el peligro de los humos producidos dependen del material utilizado, del material de soldadura y de las sustancias utilizadas para la limpieza y el desengrase de las piezas a soldar. Respete escrupulosamente las indicaciones del fabricante y las fichas técnicas.
- No suelde en lugares donde se efectúen desengrases o donde se pinte.
- Coloque las botellas de gas en espacios abiertos, o con una buena circulación de aire.

1.4 Prevención contra incendios/explosiones



El proceso de soldadura puede originar incendios y/o explosiones.

- Retire de la zona de trabajo y de aquella la circundante los materiales, o u objetos inflamables o combustibles.
- Los materiales inflamables deben estar a 11 metros (35 pies) como mínimo del local de soldadura o deben estar protegidos perfectamente.
- Las proyecciones de chispas y partículas incandescentes pueden llegar fácilmente a las zonas de circundantes, incluso a través de pequeñas aberturas. Observe escrupulosamente la seguridad de las personas y de los bienes.
- No suelde encima o cerca de recipientes bajo presión.
- No suelde recipientes o tubos cerrados. Tenga mucho cuidado durante la soldadura de tubos o recipientes, incluso si éstos están abiertos, vacíos y bien limpios. Los residuos de gas, combustible, aceite o similares podrían provocar explosiones.
- No suelde en lugares donde haya polvos, gas, o vapores explosivos.
- Al final de la soldadura, compruebe que el circuito bajo tensión no puede tocar accidentalmente piezas conectadas al circuito de masa.
- Coloque en la cerca de la zona de trabajo un equipo o dispositivo antiincendio.

1.5 Prevención durante el uso de las botellas de gas



Las botellas de gas inerte contienen gas bajo presión y pueden explotar si no se respetan las condiciones mínimas de transporte, mantenimiento y uso.

- Las botellas deben estar sujetas verticalmente a paredes o a otros soportes con elementos adecuados para que no se caigan ni se choquen contra otros objetos.
- Enrosque la tapa de protección de la válvula durante el transporte, la puesta en servicio y cuando concluyan las operaciones de soldadura.
- No exponga las botellas directamente a los rayos solares, a cambios bruscos de temperatura, a temperaturas muy altas o muy bajas. No exponga las botellas a temperaturas muy rígidas ni demasiado altas o bajas.
- Las botellas no deben tener contacto con llamas libres, con arcos eléctricos, antorchas, pinzas portaelectrodos, ni con las proyecciones incandescentes producidas por la soldadura.
- Mantenga las botellas lejos de los circuitos de soldadura y de los circuitos de corriente eléctrica en general.
- Mantenga la cabeza lejos del punto de salida del gas cuando abra la válvula de la botella.
- Cierre la válvula de la botella cuando haya terminado de soldar.
- Nunca suelde sobre una botella de gas bajo presión.
- No conecte una botella de aire comprimido directamente con el reductor de la máquina! Si la presión sobrepasa la capacidad del reductor, éste podría estallar!

1.6 Protección contra descargas eléctricas



Las descargas eléctricas suponen un peligro de muerte.

- No toque las piezas internas ni externas bajo tensión del equipo de soldadura mientras el equipo éste se encuentre activado (antorchas, pinzas, cables de masa, electrodos, alambres, rodillos y bobinas están conectados eléctricamente al circuito de soldadura).
- Compruebe el aislamiento eléctrico del equipo, utilizando superficies y bases secas y aisladas perfectamente del potencia de tierra y de masa de la tierra.
- Compruebe que el equipo esté conectado correctamente a una toma y a una fuente de alimentación dotada de conductor de protección de tierra.
- No toque simultáneamente dos antorchas, o dos pinzas portaelectrodos.
- Interrumpa inmediatamente la soldadura si nota una descarga eléctrica.

1.7 Campos electromagnéticos e interferencias



El paso de la corriente a través de los cables internos y externos del equipo crea un campo electromagnético cerca de los cables de soldadura y del mismo equipo.

- Los campos electromagnéticos pueden ser perjudiciales (desconocen los efectos exactos) para la salud de una persona expuesta durante mucho tiempo.
- Los campos electromagnéticos pueden interferir con otros equipos tales como marcapasos o aparatos acústicos.



Las personas con aparatos electrónicos vitales (marcapasos) deberían consultar al médico antes de acercarse al área donde se están efectuando soldaduras por arco.

1.7.1 Clasificación EMC in acuerdo con la Normativa: EN 60974-10/A1:2015.



Le matériel de classe B est conforme aux exigences de compatibilité électromagnétique en milieu industriel et résidentiel, y compris en environnement résidentiel où l'alimentation électrique est distribuée par un réseau public basse tension.



Le matériel de classe A n'est pas conçu pour être utilisé en environnement résidentiel où l'alimentation électrique est distribuée par un réseau public basse tension. Puede ser potencialmente difícil asegurar la compatibilidad electromagnética de los dispositivos de clase A en estas áreas, a causa de las perturbaciones irradiadas y conducidas.

Para más información, consulte el capítulo: ETIQUETA DE DATOS o CARACTERÍSTICAS TÉCNICAS.

1.7.2 Instalación, uso y evaluación del área

Este equipo responde a las indicaciones especificaciones de la norma armonizada EN 60974-10/A1:2015 y se identifica como de "CLASEA". Este equipo tiene que debe utilizarse sólo para fines profesionales en un local industrial. El fabricante no responde de daños provocados por un uso del equipo en entornos domésticos.



El usuario debe ser un experto del sector y como tal es responsable de la instalación y del uso del aparato según las indicaciones del fabricante. Si se detectasen perturbaciones electromagnéticas, el usuario del equipo tendrá que resolver la situación sirviéndose de la asistencia técnica del fabricante.



Debe procurar reducir las perturbaciones electromagnéticas hasta un nivel que no resulte molesto.



Antes de instalar este equipo, el usuario tiene que evaluar los potenciales problemas electro-magnéticos que podrían producirse en la zona circundante y, en particular, la salud de las personas expuestas, por ejemplo: personas con marcapasos y aparatos acústicos.

1.7.3 Precauciones en el uso de los cables

Para minimizar los efectos de los campos electromagnéticos, respete las siguientes reglas:

- Enrolle juntos y fije, cuando sea posible, el cable de masa y el cable de potencia.
- No se enrolle los cables alrededor del cuerpo.
- No se coloque entre el cable de masa y el cable de potencia (mantenga ambos cables del mismo lado).
- Los cables tienen que ser lo más cortos posible, estar situarse cerca el uno del otro y pasar por encima o cerca del nivel del suelo.
- Coloque el equipo a una cierta distancia de la zona de soldadura.
- Los cables deben estar apartados de otros cables.

1.7.4 Conexión equipotencial

Tenga en cuenta que todos los componentes metálicos de la instalación del equipo de soldadura (corte) y aquéllos los que se encuentran cerca tienen que estar conectados a tierra. Respete las normativas nacionales referentes a la conexión equipotencial.

1.7.5 Puesta a tierra de la pieza de trabajo

Cuando la pieza de trabajo no está conectada a tierra por motivos de seguridad eléctrica, o a debido a sus dimensiones y posición, la conexión a tierra entre la pieza y la tierra de la pieza podría reducir las emisiones. Es importante procurar en que la conexión a tierra de la pieza de trabajo no aumente el riesgo de accidente de los operadores, y que no dañe otros aparatos eléctricos. Respete las normativas nacionales referentes a la conexión a tierra.

1.7.6 Blindaje

El blindaje selectivo de otros cables y aparatos presentes en la zona circundante puede reducir los problemas de interferencia. En caso de aplicaciones especiales, también puede considerarse el blindaje de todo el equipo de soldadura.

1.8 Grado de protección IP



IP23S

- Para evitar el contacto de los dedos con partes peligrosas y la entrada de cuerpos sólidos extraños de diámetro mayor/igual a 12.5 mm.
- Envoltura protegida contra la lluvia a 60° sobre la vertical.
- Envoltura protegida contra los efectos perjudiciales debidos a la entrada de agua, cuando las partes móviles del aparato no están en movimiento.

1.9 Eliminación



¡No arroje nunca el equipo eléctrico entre los residuos comunes!

Con arreglo a la Directiva Europea 2012/19/UE sobre Residuos de Aparatos Eléctricos y Electrónicos y su implementación de acuerdo con las leyes nacionales, los aparatos eléctricos que hayan llegado al final de su ciclo de vida deben recogerse por separado y enviarse a un centro de recuperación y eliminación. El propietario del aparato debe identificar los centros de recogida autorizados consultando con las Administraciones Locales. La aplicación de la Directiva Europea permitirá mejorar el medio ambiente y la salud humana.

» Para más información, consulte el sitio web.

2. INSTALACIÓN



La instalación debe efectuarla solamente personal experto y habilitado por el fabricante.



Durante la instalación compruebe que el la fuente de alimentación esté desconectada de la toma de corriente.

2.1 Elevación, transporte y descarga

- El equipo incorpora un asa que permite desplazarlo a mano.
- El equipo no incorpora elementos específicos para la elevación.
- Utilice una carretilla elevadora de horquillas, desplazándose con cuidado a fin de evitar que el generador pueda volcarse.



- No subestime el peso del equipo, consulte las características técnicas.
- No traslade ni detenga la carga encima de personas u objetos.
- No aplique una presión excesiva sobre el equipo.

2.2 Colocación del equipo



Observe las siguientes normas:

- El acceso a los mandos y conexiones tiene que ser fácil.
- No coloque el equipo en lugares estrechos.
- No coloque nunca el equipo sobre una superficie con una inclinación superior a 10° respecto del plano horizontal.
- Coloque el equipo en un lugar seco, limpio y con ventilación apropiada.
- Proteja la instalación de la lluvia y del sol.

2.3 Conexión





Las unidades móviles están alimentadas exclusivamente con baja tensión.

2.4 Instalación

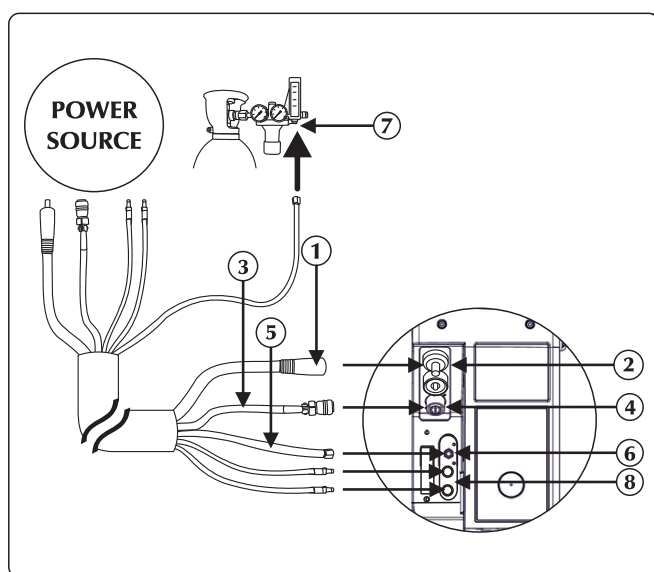
2.4.1 Conexión para soldadura MIG/MAG



- ① Cable de potencia
- ② Toma positiva de potencia (+)
- ③ Cable de señal
- ④ Entrada del cable de señal
- ⑤ Tubo de gas
- ⑥ Conexión/unión de gas
- ⑦ Conexión alimentación de gas
- ⑧ Conexión líquido refrigerante

- ▶ Conecte el cable de potencia a del haz de cables en la toma correspondiente. Inserte la clavija y gire hacia la derecha que todas las piezas queden fijadas.
- ▶ Inserte el cable de señal al del haz de cables en el conector correspondiente. Inserte el conector y gire la tuerca en sentido horario hasta que las piezas queden completamente fijadas.
- ▶ Conecte el tubo de gas al reductor de presión de la botella o al racor de suministro del gas. Ajuste el flujo de gas de 10 a 30 l/min.
- ▶ Conecte el tubo de alimentación del líquido refrigerante agua del haz de cables (color azul) al conector de salida de la unidad de refrigeración (color azul - símbolo ).
- ▶ Conecte el tubo de retorno del líquido refrigerante agua del haz de cables (color rojo) al conector de entrada de la unidad de refrigeración (color rojo - símbolo .
- ▶ Conecte el cable de señal CAN-BUS para la gestión de dispositivos externos (como RC, RI...) al conector adecuado.

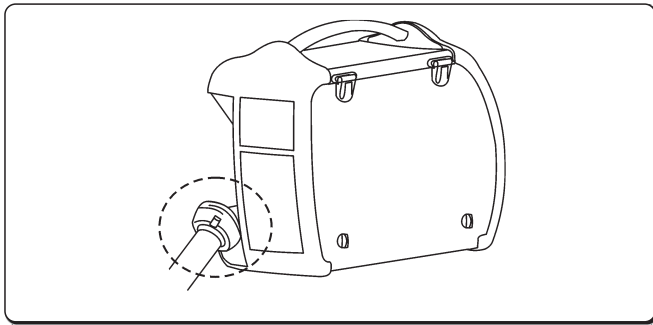

Consulte la sección "Instalación accesorios".

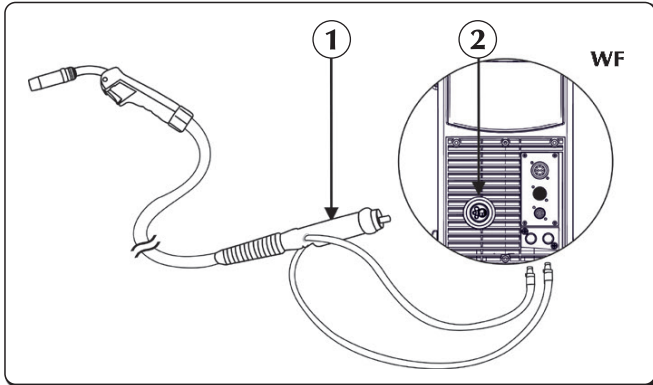

- ① Conexión de la antorcha
- ② Conectore

- ▶ Conecte el tubo de retorno del líquido refrigerante agua de color rojo de la antorcha al conector de entrada de la unidad de refrigeración (color rojo - símbolo).
- ▶ Conecte el tubo de alimentación del líquido refrigerante agua de color azul de la antorcha al conector de salida de la unidad de refrigeración (color azul - símbolo).
- ▶ Conectar la antorcha MIG/MAG al adaptador central comprobando que el anillo de sujeción esté totalmente apretado.

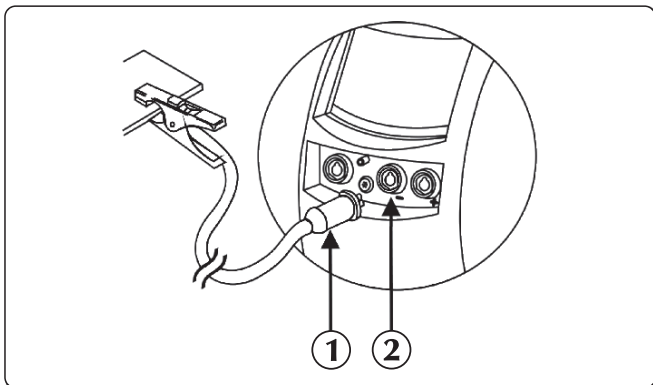

- ① Conector de la pinza de masa
- ② Toma negativa de potencia (-)

- ▶ Conecte el conector del cable de la pinza de masa a la toma negativa (-) del generador. Inserte la clavija y gire hacia la derecha que todas las piezas queden fijadas.

Compartimento del motor

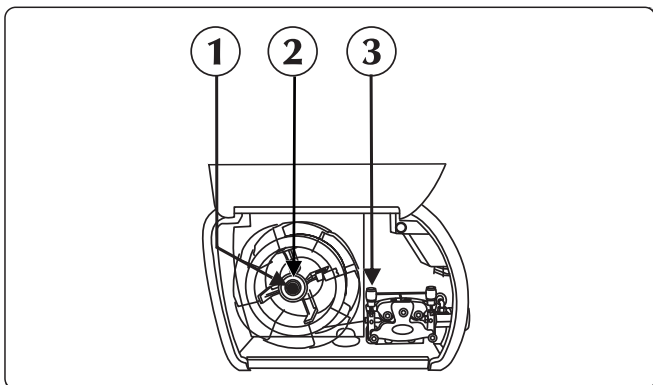

- ① Tuerca
- ② Tornillo de fricción
- ③ Soporte remolque del motorreductor

- ▶ Abra la tapa lateral derecha.
- ▶ Compruebe que la ranura del rodillo coincida con el diámetro del alambre que se desea utilizar.

- ▶ Destornille la tuerca de la devanadera portacarrete e insertar el rodillo.
- ▶ Inserte el perno del eje, introduzca la bobina, coloque la tuerca en su posición y regule el tornillo de fricción.
- ▶ Desbloquee el soporte remolque del motorreductor introduciendo la punta del alambre en la arandela guía del alambre y, haciéndolo pasar sobre el rodillo, en la conexión de la antorcha. Bloquee en posición el soporte remolque controlando que el alambre haya entrado en la ranura de los rodillos.
- ▶ Pulse el botón de avance del alambre para cargar el alambre en la antorcha.
- ▶ Ajuste el flujo de gas de 10 a 30 l/min.

3. PRESENTACIÓN DEL SISTEMA

3.1 Panel posterior

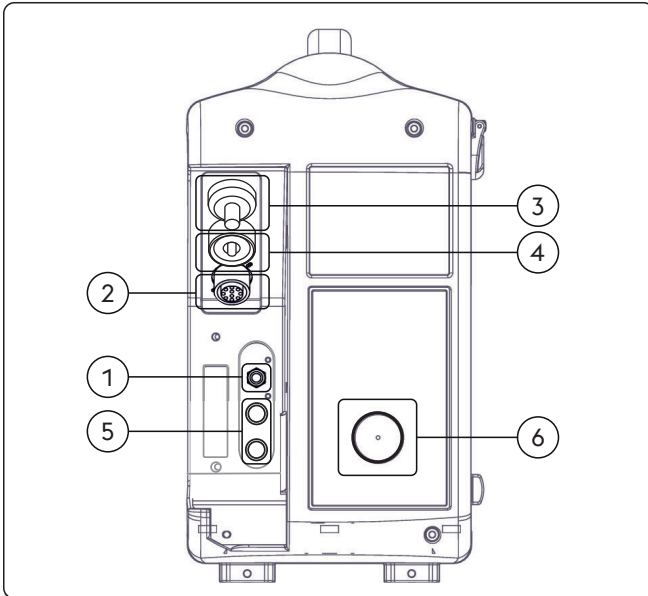

- ① Conexión de gas
- ② Entrada del cable de señal (CAN-BUS) (Manguera)
- ③ Entrada del cable de potencia (Manguera)
- ④ Toma positiva de potencia (+)
- ⑤ Entrada/salida del líquido de refrigeración
- ⑥ Entrada del alambre

ES



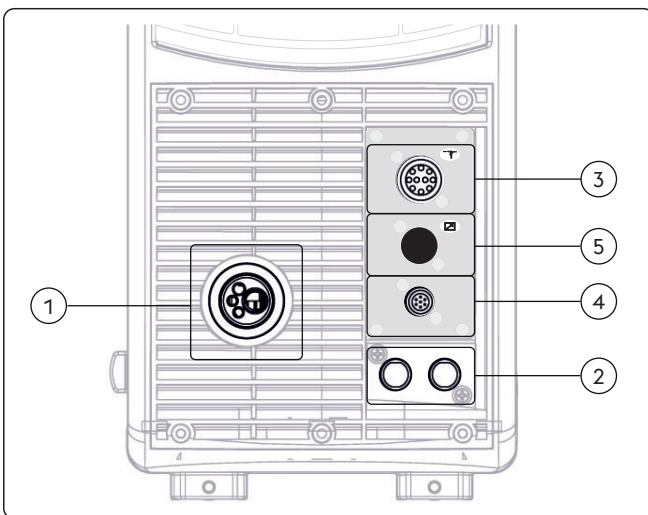



3.2 Panel de las tomas

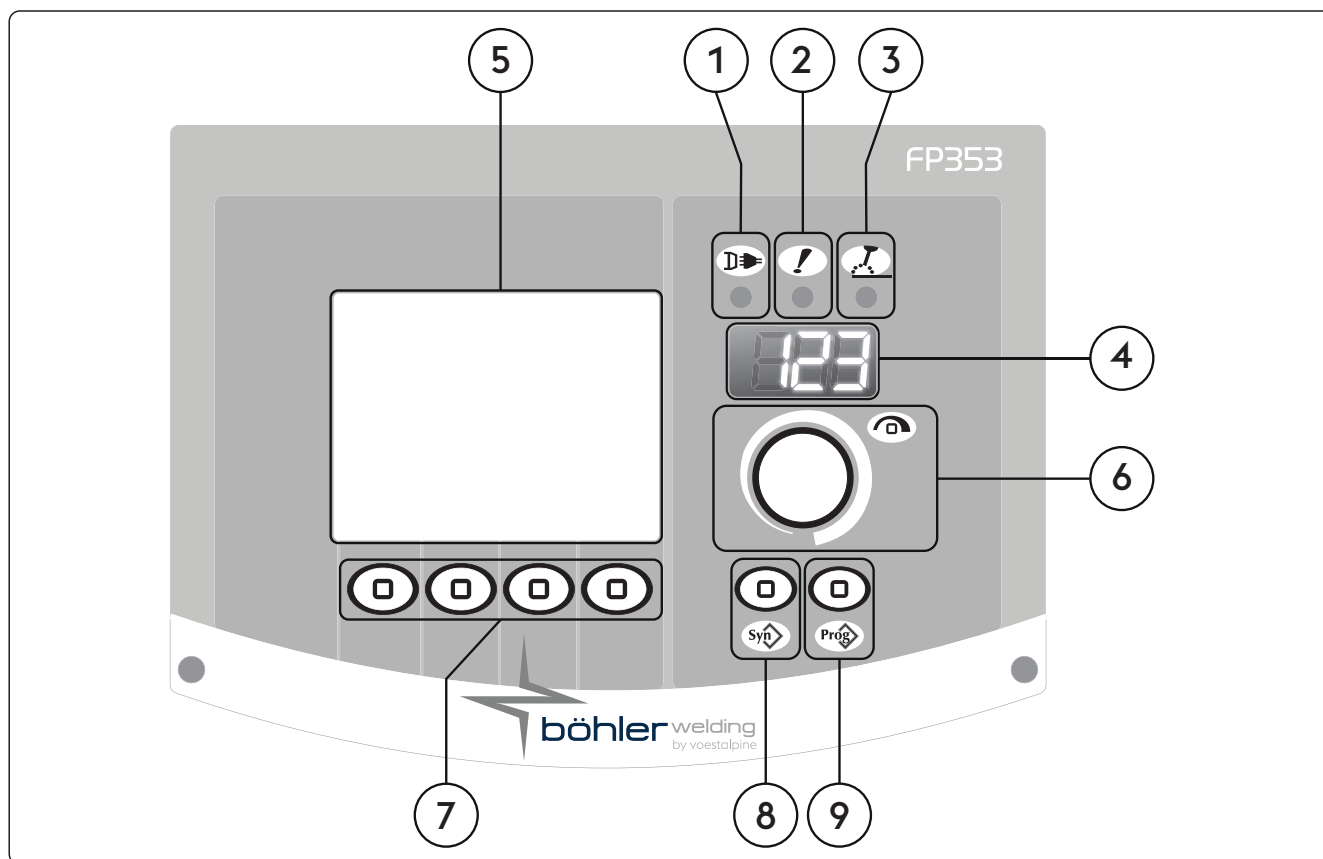

- ① Conexión de la antorcha
Permite la conexión de la antorcha MIG/MAG.
- ② Conexión líquido refrigerante
- ③ Entrada del cable de señal (Push-Pull)
- ④ Entrada del cable de señal (Antorcha)
Conexión de la antorcha
- ⑤ Entrada de cable de señal (RC)

3.3 Panel de mandos frontal



- 1  **Led de encendido**
Indica que el equipo está conectado a la red y está activado.
- 2  **Led de alarma general**
Indica la posible intervención de dispositivos de protección como la protección de temperatura.
- 3  **Led de potencia activa**
Indica la presencia de tensión en las conexiones de la toma del equipo.
- 4  **Pantalla de 7 segmentos**
Permite que se visualicen los parámetros generales de soldadura de la máquina durante el arranque, los ajustes, las lecturas de corriente y tensión, durante la soldadura, y en la codificación de las alarmas.
- 5  **Pantalla LCD**
Permite que se visualicen los parámetros generales de soldadura de la máquina durante el arranque, los ajustes, las lecturas de corriente y tensión, durante la soldadura, y en la codificación de las alarmas. Permite visualizar instantáneamente todas las operaciones.
- 6  **Encoder**
Permite que la entrada se configure, así como la selección y la configuración de los parámetros de soldadura.
- 7  **Botones de función**
Permiten seleccionar las diferentes funciones del equipo:
- Procédé de soudage
- Sequencia del micro interruptor
- Tipos de corriente
- Modalidad gráfica

8 Botón de programas de soldadura

Permite seleccionar un programa de soldadura predefinido mediante la selección de algunas informaciones sencillas:

- Tipo de hilo
- Tipo de gas
- Diámetro del alambre

9 Botón job

4. UTILIZACIÓN DEL EQUIPO

4.1 Pantalla de inicio

Durante el arranque, el generador realiza una serie de verificaciones para garantizar el correcto funcionamiento del equipo y de todos los dispositivos conectados al mismo. En esta fase también se realiza la prueba de gas para establecer la correcta conexión con el sistema de alimentación del gas.

4.2 Pantalla de test

Cuando se abre el panel lateral (alojamiento de la bobina), las operaciones de soldadura quedan inhabilitadas. Compare la pantalla de test con lo que se visualice en la LCD.

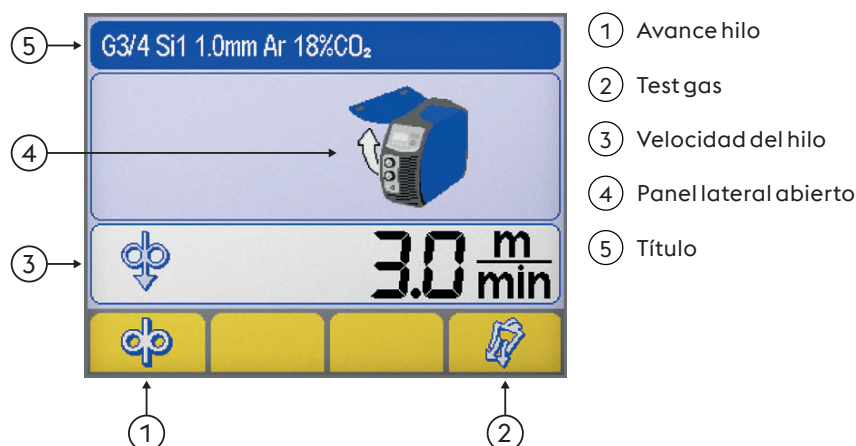

Avance hilo

Permite el avance manual del alambre sin flujo de gas y sin el alambre bajo tensión. Permite la inserción del alambre en la cubierta de la antorcha durante las fases de preparación de la soldadura.

Test gas

Permite limpiar de impurezas el circuito del gas y realizar los ajustes preliminares apropiados de presión y de flujo del gas, sin activar el equipo.

Velocidad del hilo

Permite regular la velocidad de avance del hilo (durante la etapa de carga).

Mínimo	Máximo	Por defecto
0.5 m/min	22.0 m/min	3.0 m/min

Panel lateral abierto

Título

Permite visualizar la información más importante relativa al proceso seleccionado.

4.3 Pantalla principal

Permite la gestión del equipo y del proceso de soldadura, mostrando los ajustes principales.

ES

4.4 Pantalla principal del proceso MIG/MAG

Pantalla básica

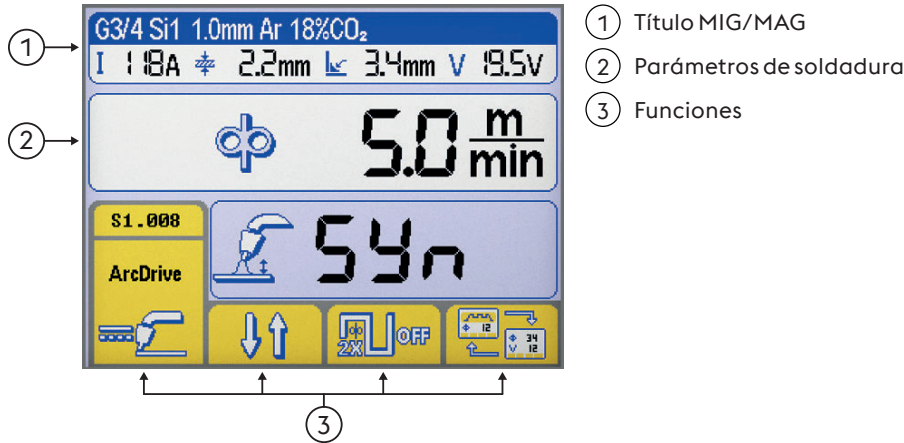

Pantalla gráfica

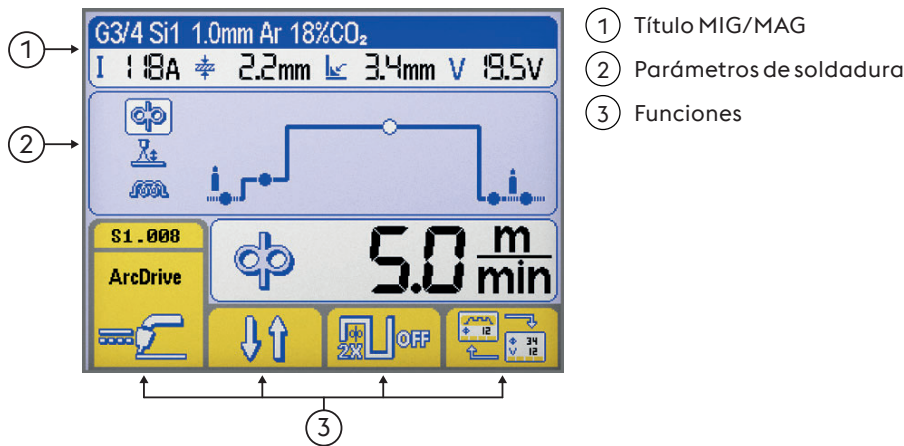

ES

Título MIG/MAG

Permite visualizar la información más importante relativa al proceso seleccionado.

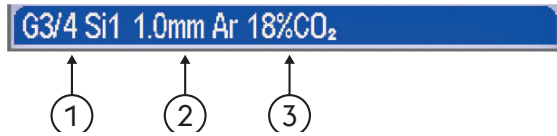

Curva sinérgica seleccionada

- ① Tipo de material de aportación
- ② Diámetro del alambre
- ③ Tipo de gas

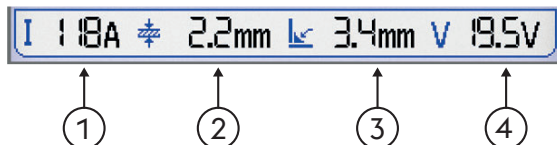

Parámetros de soldadura

- ① Corriente de soldadura
- ② Grosor de la pieza
- ③ Cordón angular "α"
- ④ Tensión de soldadura

Parámetros de soldadura (Pantalla básica)

► Seleccione el parámetro deseado pulsando la tecla encoder.

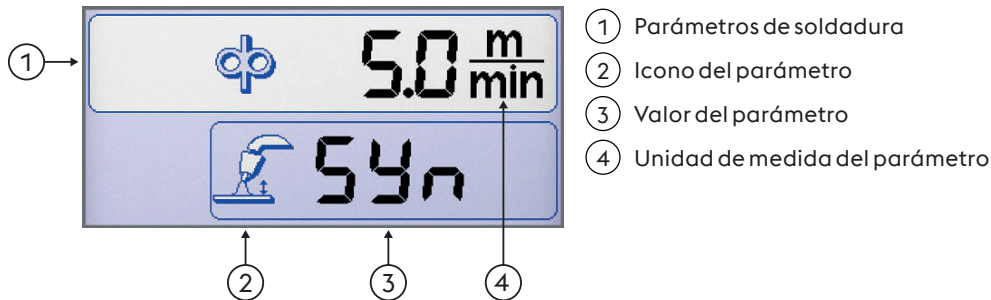

Parámetros de soldadura (Pantalla gráfica)

► Seleccione el parámetro deseado pulsando la tecla encoder.

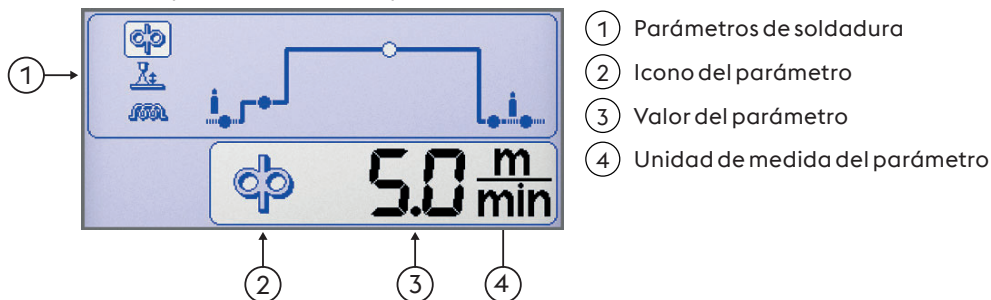

Funciones

Permiten el ajuste de las funciones de proceso y del modo de soldadura más importantes.

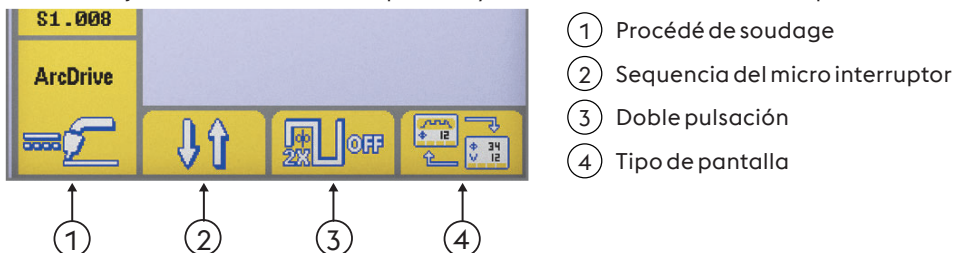

Sequencia del micro interruptor

Permite seleccionar el modo de soldadura



2 Tiempos

En dos tiempos, al pulsar el botón el gas fluye, se suministra tensión al alambre y lo hace avanzar; al soltarlo, se desactivan el gas, la tensión y el avance del alambre.



4 Tiempos

En cuatro tiempos, la primera pulsación del botón hace que el gas fluya con un tiempo de pre-gas manual; al soltarlo, se activa la tensión del alambre y su avance. La siguiente presión del botón detiene el alambre y hace que se inicie el proceso final, que vuelve a llevar la corriente hasta cero; al soltar el botón por última vez se desactiva el flujo de gas.



Crater filler

Permite realizar una soldadura con tres niveles diferentes de potencia, que el soldador puede seleccionar y controlar directamente utilizando el botón de la antorcha.

Al pulsar el botón por primera vez el gas fluye, se activa la tensión del alambre y éste avanza a la velocidad establecida por el parámetro "incremento inicial" (durante la configuración) y con los valores sinérgicos relativos de los parámetros de soldadura.

Al soltar el botón de la antorcha, la velocidad del alambre y los parámetros sinérgicos relativos cambian automáticamente a los valores principales establecidos en el panel de control.

La siguiente presión del botón de la antorcha hace que la velocidad del alambre y los parámetros sinérgicos relativos vuelvan a los valores preestablecidos (durante la configuración) del parámetro de relleno de huecos.

Al soltar el botón de la antorcha se detiene el avance del alambre y se suministra alimentación para las tiempos de burn back y post-gas.



Doble pulsación



Doble pulsación activado



Doble pulsación desactivado

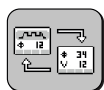

Tipo de pantalla

Permite el cambio de visualización entre:



Pantalla básica



Pantalla gráfica

Pantalla de curva sinérgica



Sinergia

Permite seleccionar un programa de soldadura predefinido (sinergia) mediante la selección de algunas informaciones sencillas

ES

Selección del proceso de soldadura

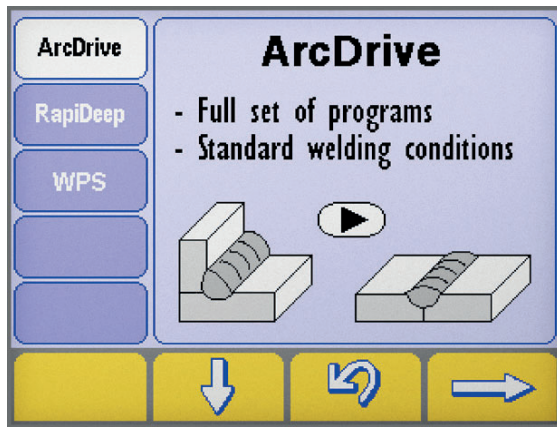

- ▶ Entre a la pantalla "sinergias" pulsando el botón durante al menos un segundo.
- ▶ Seleccione el proceso deseado pulsando los botones y .
- ▶ Pulse el botón para ir al siguiente paso.



Pantalla de selección de sinergia Tipo de material/Tipo de gas

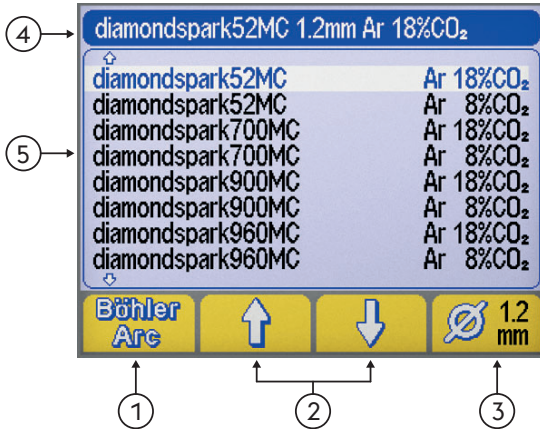

- 1 Programa de soldadura (BöhlerArc/UniversalArc)
- 2 Selección del material/gas
- 3 Diámetro del alambre
- 4 Título
- 5 Programa de soldadura



Programa de soldadura

Permite seleccionar el programa de soldadura



BöhlerArc



UniversalArc



Selección del material/gas

Pulse la sección de:



- Tipo de material de aportación
- Tipo de gas



Diámetro del alambre

Permite la selección del diámetro del alambre utilizado (mm).



- 1 Diámetro del alambre



Título

Permite visualizar la información más importante relativa al proceso seleccionado.

NO PROGRAM

Indica que la curva sinérgica seleccionada no está disponible o no es coherente con las demás configuraciones del equipo.

5. CONFIGURACIÓN

5.1 Configuración y ajuste de los parámetros

Permite la configuración y el ajuste de una serie de parámetros adicionales para garantizar un mejor y más preciso control del sistema de soldadura.

Los parámetros presentes en la configuración están organizados según el proceso de soldadura seleccionado y tienen una codificación numérica.

Entrada a la configuración



- ▶ Se produce pulsando durante 5 segundos la tecla encoder.
- ▶ La entrada será confirmada con un 0 en la pantalla.

Selección y ajuste del parámetro deseado

- ▶ El parámetro se selecciona girando el encoder hasta visualizar el código numérico relativo al parámetro deseado.
- ▶ Si pulsa la tecla encoder en este momento, podrá ver y ajustar el valor definido para el parámetro seleccionado.

Salida de la "configuración"

- ▶ Para salir de la sección "ajuste", pulse nuevamente el encoder.
- ▶ Para salir de la configuración, pase al parámetro "0" (guardar y salir) y pulse la tecla encoder.
- ▶ Anule la operación pulsando la tecla .
- ▶ Para guardar la modificación y salir de la configuración, pulse el botón: .

5.1.1 Lista de los parámetros de la configuración (MMA)

0
Guardar y salir

Permite guardar las modificaciones y salir de la configuración.

1
Reset

Permite recuperar los valores por defecto de todos los parámetros.

3
Hot start

Permite ajustar el valor de hot start en MMA.

Permite un arranque más o menos "caliente" durante el cebado del arco, facilitando las operaciones de comienzo de la soldadura.

Electrodos básico

Mínimo	Máximo	Por defecto
0/off	500%	80%

Electrodos celulósico

Mínimo	Máximo	Por defecto
0/off	500%	150%

Electrodos CrNi

Mínimo	Máximo	Por defecto
0/off	500%	100%

Electrodos de aluminio

Mínimo	Máximo	Por defecto
0/off	500%	120%

Electrodos de hierro fundido

Mínimo	Máximo	Por defecto
0/off	500%	100%

7

Corriente de soldadura

Permite ajustar la corriente de soldadura.

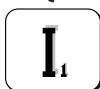

Mínimo	Máximo	Por defecto
3 A	I _{max}	100 A

8

Arc force

Permite ajustar el valor del Arc force en MMA.

Permite una respuesta dinámica, más o menos energética, durante la soldadura facilitando el trabajo del soldador.



Aumentar el valor del Arc force para reducir los riesgos de adhesión del electrodo.

Electrodos básico

Mínimo	Máximo	Por defecto
0/off	500%	30%

Electrodos celulósico

Mínimo	Máximo	Por defecto
0/off	500%	350%

Electrodos CrNi

Mínimo	Máximo	Por defecto
0/off	500%	30%

Electrodos de aluminio

Mínimo	Máximo	Por defecto
0/off	500%	100%

Electrodos de hierro fundido

Mínimo	Máximo	Por defecto
0/off	500%	70%

204

Dynamic power control (DPC)

Permite la selección de la característica V/I deseada.



I=C Corriente constante

El aumento o la reducción de la altura del arco no tiene ninguna influencia sobre la corriente de soldadura generada.

Recomendado para electrodo: Básico, Rutilo, Ácido, Acero inox, Fundición

1÷20 Característica declinante con regulación de rampa

El aumento de la altura del arco provoca la reducción de la corriente de soldadura (y viceversa) según el valor ajustado de 1 a 20 Amperios para cada Voltio.

Recomendado para electrodo: Celulosico, Aluminio

P=C Potencia constante

El aumento de la altura del arco provoca la reducción de la corriente de soldadura (y viceversa) según la fórmula $V \cdot I = K$

Recomendado para electrodo: Celulosico, Aluminio

312

Tensión de desprendimiento del arco

Permite ajustar el valor de tensión al que se fuerza la desactivación del arco eléctrico.



Permite una gestión mejorada de las diferentes condiciones de funcionamiento que se crean.

Por ejemplo, durante la soldadura por puntos, una baja tensión de desprendimiento del arco reduce las llamas al alejarse el electrodo de la pieza reduciendo las salpicaduras, quemaduras y la oxidación de la pieza.

Si utiliza electrodos que exigen altas tensiones, se aconseja ajustar un umbral alto para evitar que el arco de soldadura se desactive durante la soldadura.



Nunca ajuste una tensión de desprendimiento del arco mayor que la tensión en vacío de la fuente de alimentación.

Electrodos básico

Mínimo	Máximo	Por defecto
0/off	99.9 V	57.0 V

Electrodos celulósico

Mínimo	Máximo	Por defecto
0/off	99.9 V	70.0 V

399

Velocidad de desplazamiento

Permite configurar la velocidad de ejecución de la soldadura.



Default cm/min: velocidad de referencia para la soldadura manual.

Syn: valor sinérgico.

Mínimo	Máximo	Por defecto
1 cm/min	200 cm/min	15 cm/min

500 Configuración de la máquina

Permite seleccionar el interface gráfico deseado.
Permite acceder a los niveles superiores de la configuración.
Consulte la sección "Personalizar el interfaz (Set up 500)"

Valeur	Interfaz Usuario	Valeur	Nivel seleccionado
XE	Modo Easy	USER	Usuario
XA	Modo Advanced	SERV	Servicio
XP	Modo Professional	vaBW	vaBW

551 Lock/unlock

Permite bloquear los comandos del panel e introducir un código de protección.
Consulte la sección "Lock/unlock (Set up 551)".

552 Tono zumbador

Permite ajustar el tono del zumbador.

Mínimo	Máximo	Por defecto
0/off	10	10

601 Paso de regulación

Permite regular un parámetro con paso personalizable del operario.

Mínimo	Máximo	Por defecto
1	Imax	1

602 Parámetro externo CH1, CH2, CH3, CH4

Permite la gestión del parámetro externo 1, 2, 3, 4 (valor mínimo, valor máximo, valor por defecto, parámetro seleccionado).

Consulte la sección "Gestión de comandos externos (Set up 602)".

705 Ajuste resistencia del circuito

Permite ajustar el equipo.
Consulte la sección "Ajuste resistencia del circuito (set up 705)".

751 Lectura de corriente

Permite visualizar el valor real de la corriente de soldadura.

752 Lectura de tensión

Permite visualizar el valor real de la tensión de soldadura.

768 Medición del aporte térmico HI

Permite leer el valor de la medida del aporte térmico en la soldadura.

801 Límites de seguridad

Permite ajustar los límites de atención y los límites de seguridad.
Permite controlar el proceso de soldadura ajustando en los principales parámetros mensurables límites de atención y límites de seguridad.
Permite un control preciso de las distintas fases de soldadura.
Consulte la sección "Límites de seguridad (Set up 801)".

5.1.2 Lista de los parámetros de configuración (TIG)

0 Guardar y salir



Permite guardar las modificaciones y salir de la configuración.

1 Reset



Permite recuperar los valores por defecto de todos los parámetros.

7 Corriente de soldadura



Permite ajustar la corriente de soldadura.

Mínimo	Máximo	Por defecto
3 A	I _{max}	100 A

399 Velocidad de desplazamiento



Permite configurar la velocidad de ejecución de la soldadura.

Default cm/min: velocidad de referencia para la soldadura manual.

Syn: valor sinérgico.

Mínimo	Máximo	Por defecto
1 cm/min	200 cm/min	10 cm/min

500 Configuración de la máquina



Permite seleccionar el interface gráfico deseado.

Permite acceder a los niveles superiores de la configuración.

Consulte la sección "Personalizar el interfaz (Set up 500)"

Valeur	Interfaz Usuario
XE	Modo Easy
XA	Modo Advanced
XP	Modo Professional

Valeur	Nivel seleccionado
USER	Usuario
SERV	Servicio
vaBW	vaBW

551 Lock/unlock



Permite bloquear los comandos del panel e introducir un código de protección.

Consulte la sección "Lock/unlock (Set up 551)".

552 Tono zumbador



Permite ajustar el tono del zumbador.

Mínimo	Máximo	Por defecto
0/off	10	10

601 Paso de regulación



Permite regular un parámetro con paso personalizable del operario.

Mínimo	Máximo	Por defecto
1	I _{max}	1

602 Parámetro externo CH1, CH2, CH3, CH4



Permite la gestión del parámetro externo 1, 2, 3, 4 (valor mínimo, valor máximo, valor por defecto, parámetro seleccionado).

Consulte la sección "Gestión de comandos externos (Set up 602)".

705 Ajuste resistencia del circuito



Permite ajustar el equipo.

Consulte la sección "Ajuste resistencia del circuito (set up 705)".

751 Lectura de corriente



Permite visualizar el valor real de la corriente de soldadura.

752 Lectura de tensión

Permite visualizar el valor real de la tensión de soldadura.

758 Velocidad de desplazamiento del robot

Permite visualizar la velocidad de desplazamiento del brazo de un robot o de una automatización.

768 Medición del aporte térmico HI

Permite leer el valor de la medida del aporte térmico en la soldadura.

801 Límites de seguridad

Permite ajustar los límites de atención y los límites de seguridad.

Permite controlar el proceso de soldadura ajustando en los principales parámetros mensurables límites de atención y límites de seguridad.

Permite un control preciso de las distintas fases de soldadura.

Consulte la sección "Límites de seguridad (Set up 801)".

5.1.3 Lista de los parámetros de la configuración (MIG/MAG)
0 Guardar y salir

Permite guardar las modificaciones y salir de la configuración.

1 Reset

Permite recuperar los valores por defecto de todos los parámetros.

2 Programas de soldadura

MIG/MAG Estándar:

Permite la selección del proceso de MIG manual (Off) o de MIG sinérgico (6) especificando el tipo de material a soldar.

MIG/MAG Pulsado:

Permite la selección del proceso de MIG sinérgico (6) especificando el tipo de material a soldar.

Permite la selección del proceso de CC/CV.

3 Velocidad del hilo

Permite regular la velocidad de avance del hilo.

Mínimo	Máximo	Por defecto
0.5 m/min	22.0 m/min	-

4 Corriente

Permite ajustar la corriente de soldadura.

Mínimo	Máximo
3 A	I _{max}

5 Grosor de la pieza

Permite ajustar el espesor de la pieza a soldar.

Permite ajustar el equipo mediante la regulación de la pieza a soldar.

6 Cordón angular "a"

Permite configurar la profundidad del cordón en una unión angular.

ES



10

Pre gas

Permite ajustar y regular el flujo de gas antes del cebado del arco.
Permite la salida del gas en la antorcha y la preparación del ambiente entorno para la soldadura.

Mínimo	Máximo	Por defecto
0/off	99.9 s	0.1 s



11

Soft start

Permite el ajuste de la velocidad de avance del alambre durante las fases cebado del arco.
Permite un cebado a velocidad reducida y por tanto más suave y con menos salpicaduras.

Mínimo	Máximo	Por defecto
10 %	100 %	50 %



12

Rampa del motor

Permite configurar un paso gradual entre la velocidad del alambre de cebado y la de soldadura.

Mínimo	Máximo	Por defecto
0/off	1.0 s	0/off

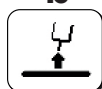

15

Burn back

Permite el ajuste del tiempo de salida del alambre impidiendo que se pegue al final de la soldadura.
Permite ajustar la longitud del trozo de alambre externo a la antorcha.

Mínimo	Máximo	Por defecto
-2.00	+2.00	0/syn



16

Post-gas

Permite ajustar el flujo de gas al final de la soldadura.

Mínimo	Máximo	Por defecto
0/off	99.9 s	2.0 s

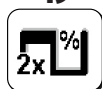

19

Duty cycle (doble pulsado)

Permite regular el duty cycle en doble pulsado.

Mínimo	Máximo	Por defecto
10 %	90 %	50 %



20

Doble pulsación

Permite regular la amplitud de la pulsación.

Mínimo	Máximo	Por defecto
0 %	100 %	±25 %
Mínimo	Máximo	Por defecto
0.5 m/min	22 m/min	2.5 m/min

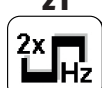
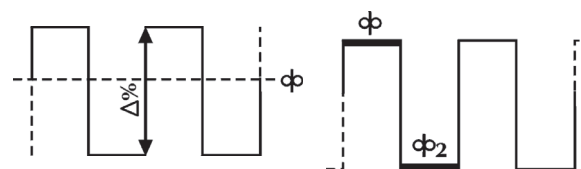

21

Frecuencia de impulsos (doble pulsado)

Permite regular el periodo, es decir, el ciclo de repetición de la pulsación.
Permite regular la frecuencia del impulso.

Mínimo	Máximo	Por defecto
0.1 Hz	5.0 Hz	2.0 Hz



22

Tensión secundaria (doble pulsado)

Permite regular la tensión del nivel de pulsación secundaria.
Permite obtener mayor estabilidad del arco en las distintas fases de pulsación.

Mínimo	Máximo	Por defecto
-5.0	+5.0	0/syn



23

Rampas de impulsos (doble pulsado)

Permite ajustar un tiempo de rampa en la fase de pulsación.

Mínimo	Máximo	Por defecto
1 %	100 %	50 %

24 Bilevel (4T - crater filler)

Permite ajustar la velocidad del hilo secundaria en el modo de soldadura Bilevel.

Si el soldador aprieta y suelta rápidamente el pulsador se pasa a “ ϕ_2 ”.

Volviendo a apretar y soltar rápidamente el pulsador, se pasa a “ ϕ ” y así sucesivamente.

Mínimo	Máximo	Por defecto
1 %	200 %	0/off

25 Incremento inicial

Permite regular el valor de la velocidad del hilo durante la primera fase de soldadura del "crater-filler".

Permite incrementar la energía transmitida a la pieza en la fase en la que el material (todavía frío) necesita más calor para fundir de forma homogénea.

Mínimo	Máximo	Por defecto
20 %	200 %	120 %

26 Crater filler

Permite regular el valor de la velocidad del hilo durante la fase de finalización de la soldadura.

Permite reducir la energía transmitida a la pieza en la fase en la que el material ya está muy caliente, reduciendo los riesgos de deformaciones innecesarias.

Mínimo	Máximo	Por defecto
20 %	200 %	80 %

27 Temporización incremento inicial

Permite configurar el tiempo de incremento inicial.

Permite automatizar la función "crater filler".

Mínimo	Máximo	Por defecto
0.1 s	99.9 s	0/off

28 Temporización crater filler

Permite configurar el tiempo de "crater filler".

Permite automatizar la función "crater filler".

Mínimo	Máximo	Por defecto
0.1 s	99.9 s	0/off

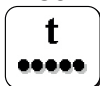
30 Soldadura por puntos

Permite activar el proceso de "soldadura por puntos" y establecer el tiempo de soldadura.

Mínimo	Máximo	Por defecto
0.1 s	99.9 s	0/off

31 Punto pausa

Permite habilitar el proceso de "punto de pausa" y establecer el tiempo de parada entre una soldadura y otra.

Mínimo	Máximo	Por defecto
0.1 s	99.9 s	0/off

32 Tensión secundaria (Bilevel MIG)

Permite regular la tensión del nivel de pulsación secundaria.

Permite obtener mayor estabilidad del arco en las distintas fases de pulsación.

Mínimo	Máximo	Por defecto
-5.0	+5.0	0/syn

33 Inductancia secundaria (Bilevel MIG)

Permite regular la inductancia del nivel de pulsación secundaria.

Permite obtener un arco relativamente rápido en la compensación de los movimientos del soldador y de la inestabilidad natural de la soldadura.

Inductancia baja = arco reactivo (más salpicaduras).

Inductancia alta = arco poco reactivo (menos salpicaduras).

Mínimo	Máximo	Por defecto
-30	+30	0/syn

ES



34 Rampa de aumento inicial

Permite configurar un paso gradual entre el aumento inicial y la soldadura.

Mínimo	Máximo	Por defecto
0 s	10 s	0/off



35 Rampa crater filler

Permite configurar un paso gradual entre la soldadura y el crater filler.

Mínimo	Máximo	Por defecto
0 s	10 s	0/off

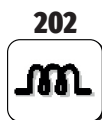

202 Inductancia

Permite una regulación electrónica de la inductancia serie del circuito de soldadura.

Permite obtener un arco relativamente rápido en la compensación de los movimientos del soldador y de la inestabilidad natural de la soldadura.

Inductancia baja = arco reactivo (más salpicaduras).

Inductancia alta = arco poco reactivo (menos salpicaduras).

Mínimo	Máximo	Por defecto
-30	+30	0/syn



331 Tensión media compensada

Permite configurar la tensión de soldadura.



398 Constante de referencia de la velocidad de desplazamiento

Constante de referencia para todos los procesos de soldadura

Valor de la velocidad de desplazamiento de la antorcha tomado como referencia por el sistema para realizar los cálculos de los parámetros de soldadura



399 Velocidad de desplazamiento

Permite configurar la velocidad de ejecución de la soldadura.

Default cm/min: velocidad de referencia para la soldadura manual.

Syn: valor sinérgico.

Mínimo	Máximo	Por defecto
syn min	syn max	35 cm/min



500 Configuración de la máquina

Permite seleccionar el interface gráfico deseado.

Permite acceder a los niveles superiores de la configuración.

Consulte la sección "Personalizar el interfaz (Set up 500)"

Valeur	Interfaz Usuario
XE	Modo Easy
XA	Modo Advanced
XP	Modo Professional

Valeur	Nivel seleccionado
USER	Usuario
SERV	Servicio
vaBW	vaBW



551 Lock/unlock

Permite bloquear los comandos del panel e introducir un código de protección.

Consulte la sección "Lock/unlock (Set up 551)".



552 Tono zumbador

Permite ajustar el tono del zumbador.

Mínimo	Máximo	Por defecto
0/off	10	10

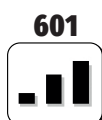

601 Paso de regulación

Permite regular un parámetro con paso personalizable del operario.

Funcionalidad controlada por botón antorcha arriba / abajo.

Mínimo	Máximo	Por defecto
1	Imax	1

602 Parámetro externo CH1, CH2, CH3, CH4

Permite la gestión del parámetro externo 1, 2, 3, 4 (valor mínimo, valor máximo, valor por defecto, parámetro seleccionado).

Consulte la sección "Gestión de comandos externos (Set up 602)".

606
Antorcha U/D

Permite la gestión del parámetro externo (U/D).

Valeur	Por defecto	Función de devolución de llamada
0/off	-	off
1/I1	X	Corriente
	-	Recuperar programas

612
Ajuste Antorcha DgMig

Permite la gestión de los canales de la antorcha digital.

Valeur	Por defecto	Función de devolución de llamada
0/off	-	off
1/I1	-	Corriente
2/ 	-	Recuperar programas
3/CH3	-	CH3
4/CH4	-	CH4
5/STD	X	STD

653
Velocidad del hilo

Permite regular la velocidad de avance del hilo (durante la etapa de carga).

Mínimo	Máximo	Por defecto
0.5 m/min	22.0 m/min	3.0 m/min

705
Ajuste resistencia del circuito

Permite ajustar el equipo.

Consulte la sección "Ajuste resistencia del circuito (set up 705)".

751
Lectura de corriente

Permite visualizar el valor real de la corriente de soldadura.

752
Lectura de tensión

Permite visualizar el valor real de la tensión de soldadura.

755
Lectura de capacidad del gas

Permite visualizar el valor real del flujo de gas.

757
Lectura de la velocidad del alambre

Lectura encoder motor 1.

758
Velocidad de desplazamiento del robot

Permite visualizar la velocidad de desplazamiento del brazo de un robot o de una automatización.

760
Lectura de corriente (motor 1)

Permite visualizar el valor real de la corriente (motor 1).

ES

768 Medición del aporte térmico HI



Permite leer el valor de la medida del aporte térmico en la soldadura.

770 Valor de la tasa de deposición



Permite la visualización del valor de la tasa de deposición.

801 Límites de seguridad



Permite ajustar los límites de atención y los límites de seguridad.

Permite controlar el proceso de soldadura ajustando en los principales parámetros mensurables límites de atención y límites de seguridad.

Permite un control preciso de las distintas fases de soldadura.

Consulte la sección "Límites de seguridad (Set up 801)".

5.2 Procedimientos específicos de uso de los parámetros

5.2.1 Personalizar pantalla 7 segmentos

Permite visualizar constantemente el valor de un parámetro en la pantalla de 7 segmentos.

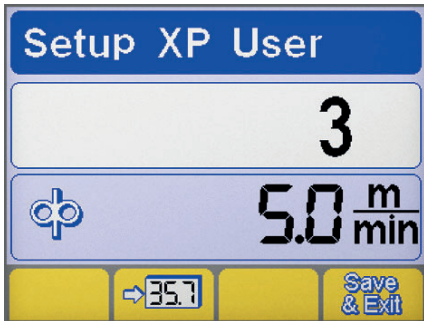

- ▶ Entre en la configuración pulsando la tecla encoder durante al menos 5 segundos.
- ▶ Seleccione el parámetro deseado girando el encoder.
- ▶ Memorice el parámetro seleccionado en la pantalla de 7 segmentos pulsando la tecla .
- ▶ Guarde y salga de la pantalla actual pulsando la tecla .

ES

5.2.2 Personalizar el interfaz (Set up 500)

Permite personalizar los parámetros en la pantalla principal.

500 Configuración de la máquina



Permite seleccionar el interface gráfico deseado.

Valeur	Interfaz Usuario
XE	Modo Easy
XA	Modo Advanced
XP	Modo Professional

MODALIDAD XE

MIG/MAG

Parámetros de soldadura

Funciones

MODALIDAD XA

MIG/MAG

Parámetros de soldadura

Funciones

MODALIDAD XP

MIG/MAG

Parámetros de soldadura	
Funciones	

5.2.3 Lock/unlock (Set up 551)

Permite bloquear los comandos del panel e introducir un código de protección.

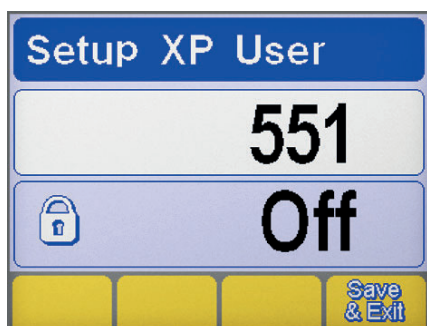
Selección parámetro

- ▶ Entre en la configuración pulsando la tecla encoder durante al menos 5 segundos.
- ▶ Seleccione el parámetro deseado (551).
- ▶ Active la regulación del parámetro seleccionado pulsando la tecla encoder.

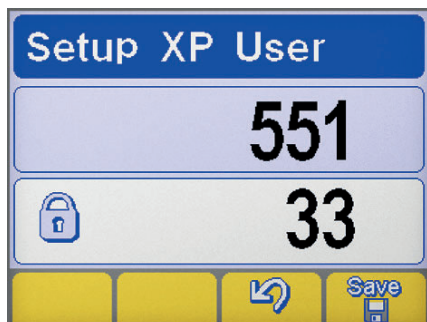
Configuración contraseña

- ▶ Ajuste una codificación numérica (contraseña) girando el encoder.
- ▶ Confirme la operación pulsando el botón encoder.
- ▶ Anule la operación pulsando la tecla
- ▶ Para guardar la modificación, pulse el botón:

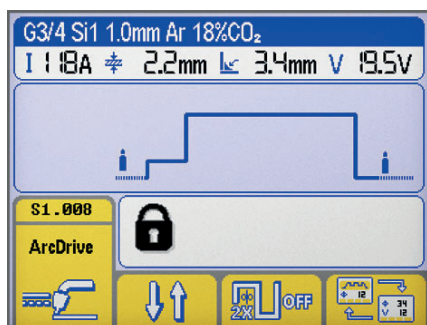
Funciones del panel

- ▶ Acceda temporalmente (5 minutos) a las funciones del panel girando el encoder e introduciendo el código numérico correcto.
- ▶ Confirme la operación pulsando el botón encoder.
- ▶ Puede desbloquear definitivamente el panel de comandos entrando en la configuración (siga las indicaciones descritas anteriormente) y reajustando el parámetro 551 a "off".
- ▶ Confirme la operación pulsando el botón encoder.
- ▶ Para guardar la modificación, pulse el botón:

5.2.4 Gestión de comandos externos (Set up 602)

Permite la gestión del parámetro externo 2 (valor mínimo, valor máximo, valor por defecto, parámetro seleccionado).

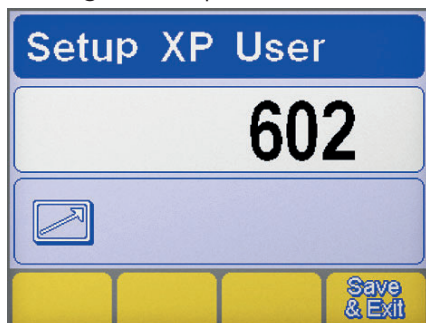
Selección parámetro

- ▶ Entre en la configuración pulsando la tecla encoder durante al menos 5 segundos.
- ▶ Seleccione el parámetro deseado (602).
- ▶ Entre en la pantalla "Gestión de comandos externos" pulsando la tecla encoder.

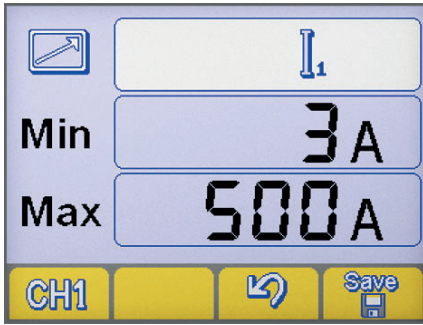

Gestión de comandos externos

- ▶ Seleccione la salida de control RC deseada (CH1, CH2, CH3, CH4) pulsando la tecla.
- ▶ Seleccione el parámetro deseado (Mín.-Máx.-parámetro) pulsando la tecla encoder.
- ▶ Regule el parámetro deseado (Mín.-Máx.-parámetro) girando el encoder.
- ▶ Para guardar la modificación, pulse el botón:
- ▶ Anule la operación pulsando la tecla

5.2.5 Ajuste resistencia del circuito (set up 705)

Permite ajustar el generador en la resistencia del circuito de soldadura actual.

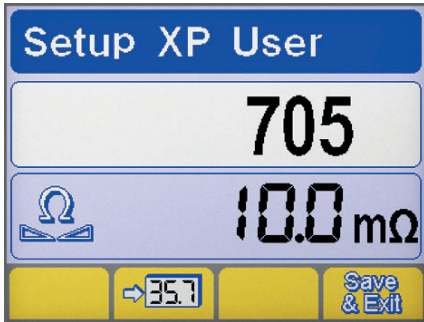

Selección parámetro

- ▶ Entre en la configuración pulsando la tecla encoder durante al menos 5 segundos.
- ▶ Seleccione el parámetro deseado (705).
- ▶ Active la regulación del parámetro seleccionado pulsando la tecla encoder.
- ▶ Conecte el generador al circuito de soldadura (banco o pieza).
- ▶ Retire la tobera para colocar la punta de contacto expuesta de la antorcha. (MIG/MAG)

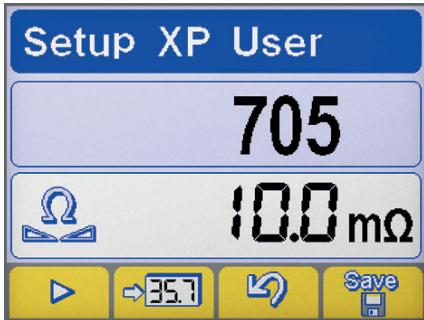

Pantalla de "INFO"

- ▶ Ponga en contacto eléctrico la punta del guía-hilo y la pieza a soldar. (MIG/MAG)
- ▶ Pulse el botón para iniciar el procedimiento.
- ▶ Mantenga el contacto durante al menos un segundo.
- ▶ El valor que se visualiza en la pantalla se actualizará cuando se complete el ajuste.
- ▶ Anule la operación pulsando la tecla
- ▶ Anule la operación pulsando la tecla
- ▶ Para guardar la modificación y salir de la configuración, pulse el botón:

5.2.6 Límites de seguridad (Set up 801)

Permite ajustar los límites de atención y los límites de seguridad.

Permite controlar el proceso de soldadura ajustando en los principales parámetros mensurables límites de atención y límites de seguridad.

Permite un control preciso de las distintas fases de soldadura.

Consulte la sección "Límites de seguridad (Set up 801)".



Corriente de soldadura	Tensión de soldadura
Lectura de capacidad del gas	Velocidad de desplazamiento del robot
Lectura de corriente (motor 1)	Lectura de corriente (motor 2)
Lectura del flujo del líquido refrigerante	Lectura de la velocidad del alambre
Lectura de temperatura del líquido refrigerante	

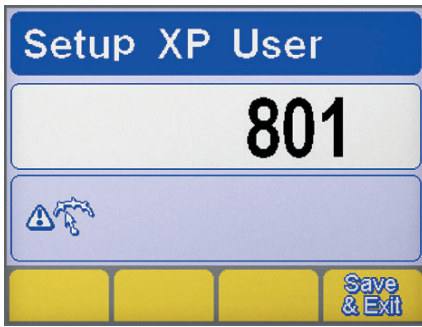

Selección parámetro

- ▶ Entre en la configuración pulsando la tecla encoder durante al menos 5 segundos.
- ▶ Seleccione el parámetro deseado (801).
- ▶ Entre en la pantalla "Límites de seguridad" pulsando la tecla encoder.

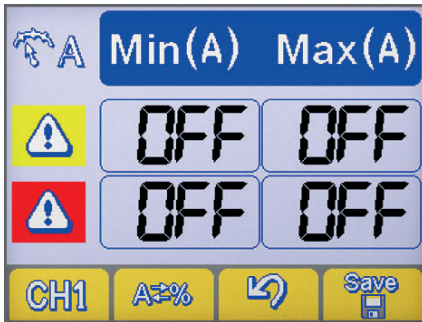

Selección del parámetro

- ▶ Seleccione el parámetro deseado pulsando la tecla **CH1**.
- ▶ Seleccione el modo de ajuste de los límites de seguridad pulsando la tecla **A=%**.

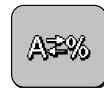

Configuración de la máquina



Valor absoluto



Valor porcentual

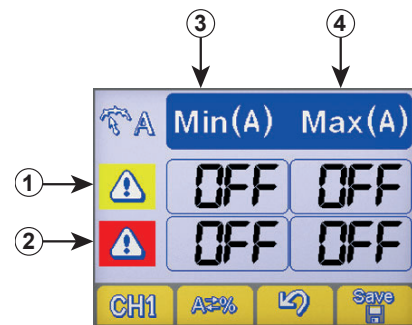

Configuración límites de protección

- 1 Línea de los límites de atención
- 2 Línea de los límites de alarma
- 3 Columna de los niveles mínimos
- 4 Columna de los niveles máximos

- ▶ Seleccione la casilla deseada pulsando la tecla encoder (la casilla seleccionada se visualiza con contraste invertido).
- ▶ Regule el nivel del límite seleccionado girando el encoder.
- ▶ Para guardar la modificación, pulse el botón: **Save**.



Si supera uno de los límites de atención, se visualizará una señal en el panel de comandos.



Si supera uno de los límites de alarma, se visualizará una señal en el panel de comandos y se bloquearán inmediatamente las operaciones de soldadura.



Es posible ajustar los filtros de inicio y finalización de la soldadura para evitar señales de error en las fases de inicio y fin del arco (consulte la sección "Configuración" - Parámetros 802-803-804).

6. ACCESORIOS

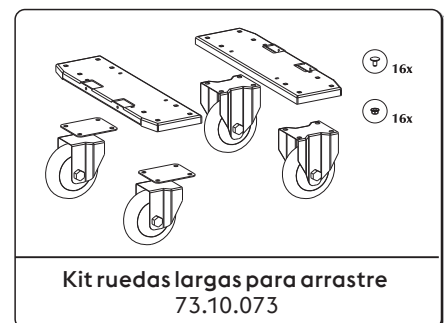
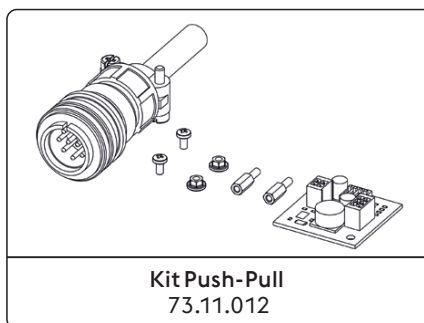
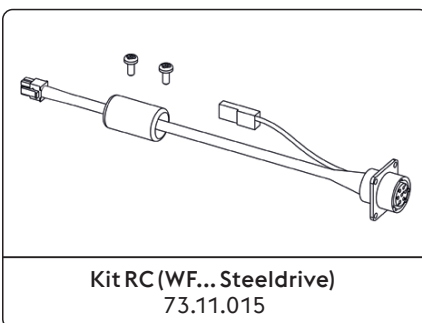

ES

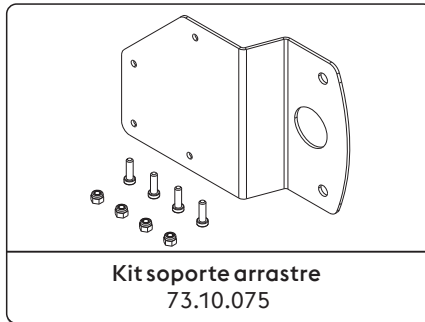
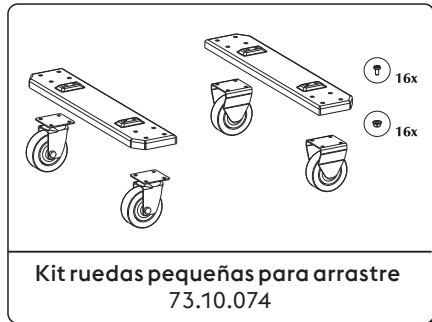

*Montaje de fábrica
Consulte la sección "Instalación kit/accesorios".

7. MANTENIMIENTO



Efectúe el mantenimiento ordinario del equipo según las indicaciones del fabricante. Cuando el equipo esté funcionando, todas las puertas de acceso y de servicio y las tapas tienen que estar cerradas y fijadas perfectamente. El equipo no debe ser modificado. Procure que no se forme polvo metálico en proximidad y cerca o encima de las aletas de ventilación.



El mantenimiento debe efectuarlo personal cualificado. La reparación o la sustitución de componentes del sistema por parte de personal no autorizado provoca la caducidad inmediata de la garantía del producto. La reparación o sustitución de componentes del equipo debe ser hecha realizarla personal técnico cualificado.



¡Antes de cada operación, desconecte el equipo!

7.1 Controles periódicos de la fuente de alimentación



Limpie el interior con aire comprimido a baja presión y con pinceles de cerdas suaves. Compruebe las conexiones eléctricas y todos los cables de conexión.

7.2 Responsabilidad



La carencia de este mantenimiento, provocará la caducidad de todas las garantías y el fabricante se considerará exento de toda responsabilidad. Si el operador no respetara las instrucciones descritas, el fabricante declina cualquier responsabilidad. Si tuviera dudas y/o problemas no dude en consultar al centro de asistencia técnica más cercano.

8. CODIFICACIÓN DE ALARMAS



ALARMA

La activación de una alarma o la superación de un límite de seguridad crítico provoca una señal visual en el panel de mandos y el bloqueo inmediato de las operaciones de soldadura.



ATENCIÓN

Si se supera un límite de protección, se activa una señal visual en el panel de mandos, pero es posible continuar con las operaciones de soldadura.

A continuación se enumeran todas las alarmas y todos los límites de protección relativos al sistema.

E01	Exceso de temperatura		E02	Exceso de temperatura	
E05	Sobrecorriente		E07	Fallo del sistema de alimentación del motor del alimentador de alambre	
E08	Motor bloqueado		E10	Sobrecorriente módulo de potencia (Inverter)	
E12.1	Error de comunicación WF1		E13	Error de comunicación (FP)	

 E14.xx	Programa no válido el subcódigo del error indica el número del trabajo eliminado		 E15	Programa no válido	
 E16.1	Error de comunicación RI 1000/2000/3000 (CAN bus)		 E16.2	Error de comunicación RI 3000 (Modbus)	
 E16.3	Error de comunicación RI 1000/2000		 E18.xx	Programa no válido el subcódigo del error indica el número del trabajo eliminado	
 E19	Error de configuración del sistema		 E19.1	Error de configuración del sistema	
 E19.11	Error de configuración del sistema (WF)		 E20	Memoria averiada	
 E21	Pérdida de datos		 E23	Programas de soldadura no presentes	
 E27	Memoria averiada (RTC)		 E32	Pérdida de datos	
 E33.1	Error de configuración del sistema (LCD 3.5")		 E33.3	Error de comunicación (ACTIVATION KEY)	
 E33.4	Error de comunicación (ACTIVATION KEY)		 E40	Fallo alimentación del equipo	
 E43	Falta líquido refrigerante		 E44	Falta gas	
 E48	Falta alambre (Automatización y robótica)		 E50	Alambre pegado (Automatización y robótica)	
 E54	Superado el nivel de corriente (Límite inferior)		 E55	Superado el nivel de corriente (Límite superior)	
 E56	Superado el nivel de tensión (Límite inferior)		 E57	Superado el nivel de tensión (Límite superior)	
 E58	Superado el nivel de flujo de gas (Límite inferior)		 E59	Superado el nivel de flujo de gas (Límite superior)	
 E62	Superado el nivel de corriente (Límite inferior)		 E63	Superado el nivel de corriente (Límite superior)	
 E64	Superado el nivel de tensión (Límite inferior)		 E65	Superado el nivel de tensión (Límite superior)	
 E66	Superado el nivel de flujo de gas (Límite inferior)		 E67	Superado el nivel de flujo de gas (Límite superior)	

E71	Sobrettemperatura líquido refrigerante	E74	Superado el nivel de corriente motor 1
E76	Superado el nivel de flujo líquido refrigerante	E77	Nivel de temperatura líquido refrigerante
E80	Falta alambre (wire end)	E81	Sobrecorriente (bomba WU)
E82	Error de comunicación (WU)	E83	Bomba bloqueada
E99.2	Alarma de configuración del equipo (inverter)	E99.3	Alarma de configuración del equipo (FP)
E99.4	Alarma de configuración del equipo (FP)	E99.5	Alarma de configuración del equipo (FP)
E99.6	Alarma de configuración del equipo	E99.11	Memoria averiada

ES

9. DIAGNÓSTICO Y SOLUCIÓN DE PROBLEMAS

Alimentación del alambre bloqueada

Causa

- » Botón de la antorcha averiado.
- » Rodillos inadecuados o gastados.
- » Alimentador del alambre averiado.
- » Recubrimiento de la antorcha dañado.
- » El alimentador del alambre no recibe corriente.
- » Alambre enredado en la bobina.
- » Boquilla de la antorcha fundida (hilo pegado).

Solución

- » Sustituya el componente averiado.
- » Contacte con el centro de asistencia más cercano para la reparación del sistema.
- » Sustituya los rodillos.
- » Sustituya el componente averiado.
- » Contacte con el centro de asistencia más cercano para la reparación del sistema.
- » Sustituya el componente averiado.
- » Contacte con el centro de asistencia más cercano para la reparación del sistema.
- » Compruebe la conexión a la fuente de alimentación.
- » Consulte el párrafo "Conexiones".
- » Contacte con el centro de asistencia más cercano para la reparación del sistema.
- » Desenrede el alambre o sustituya la bobina.
- » Sustituya el componente averiado.

Alimentación de alambre irregular

Causa

- » Botón de la antorcha averiado.
- » Rodillos inadecuados o gastados.
- » Alimentador del alambre averiado.
- » Recubrimiento de la antorcha dañado.

Solución

- » Sustituya el componente averiado.
- » Contacte con el centro de asistencia más cercano para la reparación del sistema.
- » Sustituya los rodillos.
- » Sustituya el componente averiado.
- » Contacte con el centro de asistencia más cercano para la reparación del sistema.
- » Sustituya el componente averiado.
- » Contacte con el centro de asistencia más cercano para la reparación del sistema.

» Embrague enrollador o dispositivos de bloqueo de los rodillos mal regulados.

» Afloje el embrague.
 » Aumente la presión en los rodillos.

Inclusiones de escoria

Causa

» Limpieza incompleta.
 » Electrodo de diámetro muy grueso.
 » Preparación incorrecta de los bordes.
 » Modo de soldadura incorrecto.

Solución

» Limpie perfectamente las piezas antes de la soldadura.
 » Utilice un electrodo de diámetro más pequeño.
 » Aumente la apertura del achaflanado.
 » Reduzca la distancia entre electrodo y pieza.
 » Avance regularmente durante la soldadura.

Sopladuras

Causa

» Protección de gas insuficiente.

Solución

» Ajuste el flujo de gas.
 » Compruebe que el difusor y la boquilla de gas de la antorcha estén en buenas condiciones.

Encoladura

Causa

» Longitud de arco incorrecta.
 » Parámetros de soldadura incorrectos.
 » Modo de soldadura incorrecto.
 » Las piezas a soldar son demasiado grandes.
 » Dinámica de arco incorrecta.

Solución

» Aumente la distancia entre electrodo y pieza.
 » Aumente la tensión de soldadura.
 » Aumente la corriente de soldadura.
 » Aumente la tensión de soldadura.
 » Aumente el ángulo de inclinación de la antorcha.
 » Aumente la corriente de soldadura.
 » Aumente la tensión de soldadura.
 » Aumente el valor inductivo del circuito.

Incisiones marginales

Causa

» Parámetros de soldadura incorrectos.
 » Longitud de arco incorrecta.
 » Modo de soldadura incorrecto.
 » Protección de gas insuficiente.

Solución

» Reduzca la tensión de soldadura.
 » Reduzca la distancia entre electrodo y pieza.
 » Reduzca la tensión de soldadura.
 » Reduzca la velocidad de oscilación lateral en el llenado.
 » Reduzca la velocidad de avance durante la soldadura.
 » Utilice gases adecuados para los materiales a soldar.

Oxidaciones

Causa

» Protección de gas insuficiente.

Solución

» Ajuste el flujo de gas.
 » Compruebe que el difusor y la boquilla de gas de la antorcha estén en buenas condiciones.

Porosidades

Causa

» Presencia de grasa, pintura, óxido o suciedad en las piezas a soldar.
 » Presencia de grasa, pintura, óxido o suciedad en el material de aportación.
 » Presencia de humedad en el material de aportación.
 » Longitud de arco incorrecta.

Solución

» Limpie perfectamente las piezas antes de la soldadura.
 » Utilice siempre productos y materiales de calidad.
 » Mantenga siempre en perfectas condiciones el material de aportación.
 » Utilice siempre productos y materiales de calidad.
 » Mantenga siempre en perfectas condiciones el material de aportación.
 » Reduzca la distancia entre electrodo y pieza.
 » Reduzca la tensión de soldadura.

- | | |
|---|--|
| <ul style="list-style-type: none"> » Presencia de humedad en el gas de soldadura. | <ul style="list-style-type: none"> » Utilice siempre productos y materiales de calidad. » Mantenga en perfectas condiciones el sistema de suministro del gas. |
| <ul style="list-style-type: none"> » Protección de gas insuficiente. | <ul style="list-style-type: none"> » Ajuste el flujo de gas. » Compruebe que el difusor y la boquilla de gas de la antorcha estén en buenas condiciones. |
| <ul style="list-style-type: none"> » Solidificación muy rápida de la soldadura de inserción. | <ul style="list-style-type: none"> » Reduzca la velocidad de avance durante la soldadura. » Precaliente las piezas a soldar. » Aumente la corriente de soldadura. |

Grietas en caliente

Causa

- » Parámetros de soldadura incorrectos.
- » Presencia de grasa, pintura, óxido o suciedad en las piezas a soldar.
- » Presencia de grasa, pintura, óxido o suciedad en el material de aportación.
- » Modo de soldadura incorrecto.
- » Piezas a soldar con características diferentes.

Solución

- » Reduzca la tensión de soldadura.
- » Limpie perfectamente las piezas antes de la soldadura.
- » Utilice siempre productos y materiales de calidad.
- » Mantenga siempre en perfectas condiciones el material de aportación.
- » Siga las secuencias operativas correctas para el tipo de unión a soldar.
- » Aplique un depósito superficial preliminar antes de la soldadura.

Grietas en frío

Causa

- » Presencia de humedad en el material de aportación.
- » Forma especial de la unión a soldar.

Solución

- » Utilice siempre productos y materiales de calidad.
- » Mantenga siempre en perfectas condiciones el material de aportación.
- » Precaliente las piezas a soldar.
- » Haga un postcalentamiento.
- » Siga las secuencias operativas correctas para el tipo de unión a soldar.

ES

10. INSTRUCCIONES DE USO

10.1 Soldadura con alambre continuo (MIG/MAG)

Introducción

Un sistema MIG está formado por una fuente de alimentación de corriente continua, un alimentador y una bobina de alambre, una antorcha y gas.

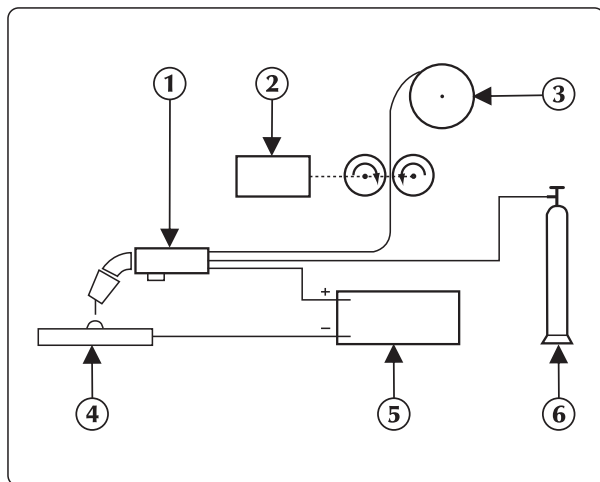

Sistema de soldadura manual MIG

La corriente llega al arco por el electrodo fusible (alambre con polaridad positiva); En este procedimiento el metal fundido se transmite a la pieza por soldar mediante el arco.

El avance automático del electrodo del material de aportación continuo (alambre) es necesario para reintegrar el alambre fundido durante la soldadura.

1. Antorcha
2. Arrastrador de hilo
3. Alambre de soldadura
4. Pieza a soldar
5. Generador
6. Botella

Métodos

MIG, disponemos de dos mecanismos principales de transferencia del metal, que pueden clasificarse según los medios de transmisión del metal desde el electrodo hasta la pieza a soldar.

El primer método definido como "TRANSFERENCIA EN CORTO CIRCUITO (SHORT-ARC)", crea un pequeño baño de soldadura de solidificación rápida en que el metal se transfiere desde el electrodo hasta la pieza a soldar durante un corto periodo en que el electrodo entra en contacto con el baño. En este intervalo, el electrodo entra en contacto directo con el baño de soldadura, generando un cortocircuito que funde el alambre, y que por lo tanto se interrumpe. Entonces el arco vuelve a encenderse y el ciclo se repite.

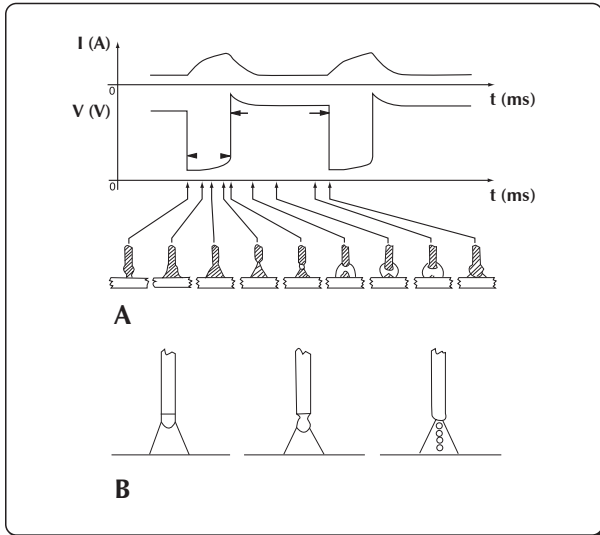

Ciclo SHORT y soldadura SPRAY ARC

Otro método para conseguir la transferencia del metal es la "TRANSFERENCIA CON ROCIADO (SPRAY-ARC)", donde la transferencia del metal se produce en forma de gotas muy pequeñas que se forman y se desprenden de la punta del alambre, y se transfieren al baño de soldadura mediante el flujo del arco.

Parámetros de soldadura

La visibilidad del arco reduce la necesidad de una rígida observar estrictamente las tablas de ajuste por parte del operador que tiene la posibilidad de controlar directamente el baño de soldadura.

- La tensión influencia directamente el aspecto del cordón, pero las dimensiones de la superficie soldada se pueden variar según las exigencias, actuando manualmente sobre el moviendo manualmente la antorcha en modo para obtener depósitos variables con tensión constante.
- La velocidad de avance del alambre es proporcional a la corriente de soldadura.

En las dos figuras siguientes se muestran las relaciones entre los diferentes parámetros de soldadura.

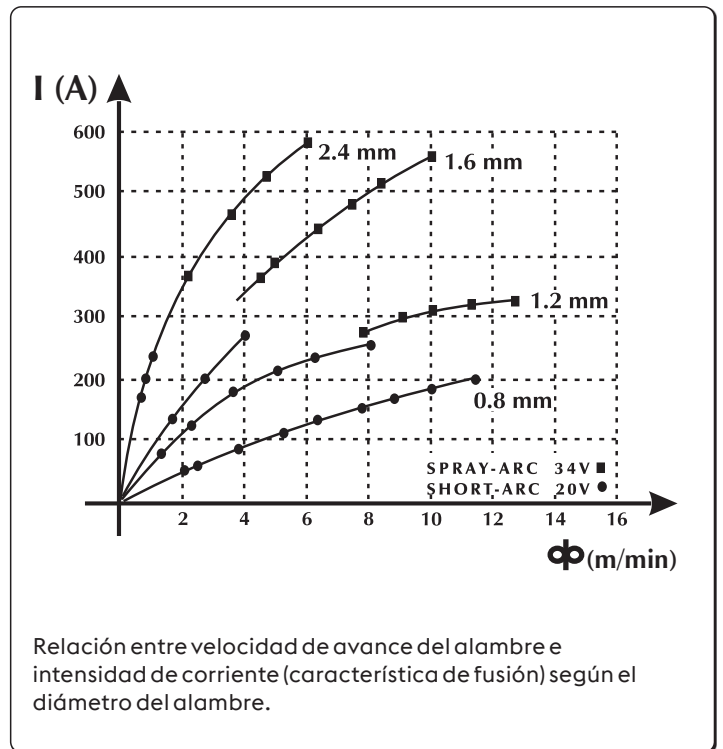
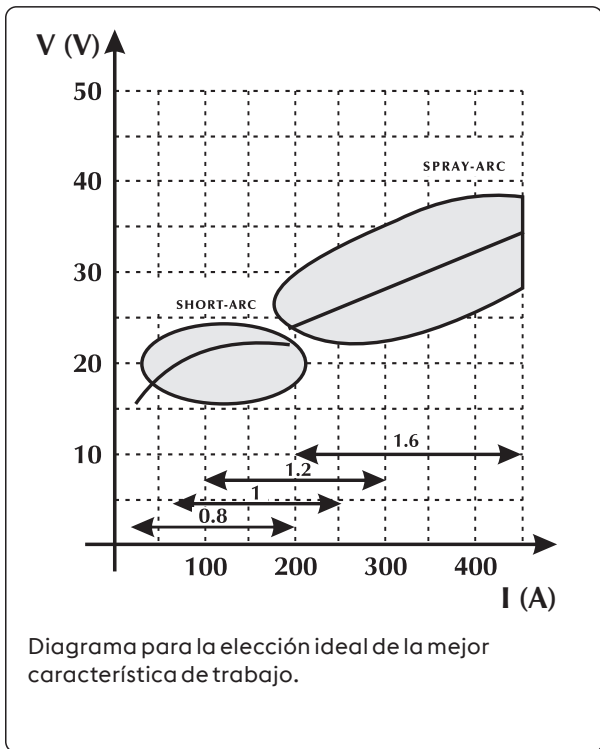

ES

Tabla guía aproximada para la elección de los parámetros de soldadura referida a las aplicaciones más típicas y a los alambre más utilizados

Tensión de arco	Ø 0,8 mm	Ø 1,0-1,2 mm	Ø 1,6 mm	Ø 2,4 mm
16V - 22V SHORT - ARC				
	60 - 160 A Baja penetración para pequeños espesores	100 - 175 A Buen control de la penetración y la fusión	120 - 180 A Buena fusión en plano y en vertical	150 - 200 A No utilizado
	<hr/>			
	24V - 28V SEMI SHORT-ARC (Zona de transición)			
150 - 250 A Soldadura automática de ángulo		200 - 300 A Soldadura automática a tensión alta	250 - 350 A Soldadura automática descendiente	300 - 400 A No utilizado
<hr/>				
30V - 45V SPRAY - ARC				
	150 - 250 A Baja penetración con ajuste a 200 A	200 - 350 A Soldadura automática con pasadas múltiples	300 - 500 A Buena penetración descendiente	500 - 750 A Buena penetración, alto depósito en grandes espesores

ES

Unalloyed steel

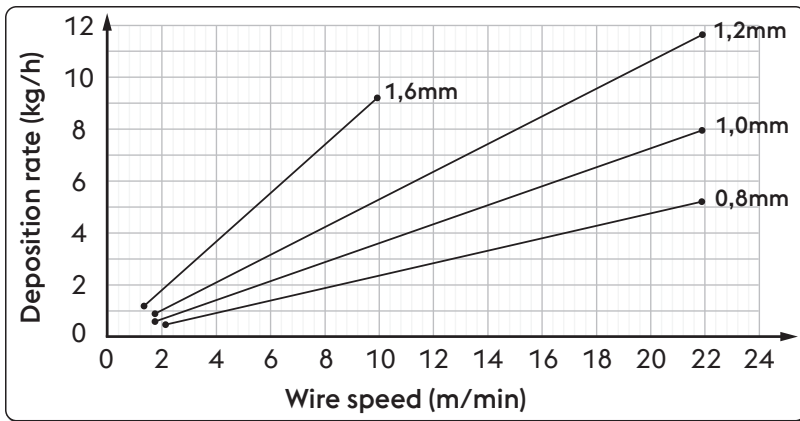

Ø	Wire speed	Deposition rate
0,8 mm	2,0 m/min	0,5 kg/h
	22,0 m/min	5,3 kg/h
1,0 mm	1,6 m/min	0,6 kg/h
	22,0 m/min	8,1 kg/h
1,2 mm	1,6 m/min	0,9 kg/h
	22,0 m/min	11,7 kg/h
1,6 mm	1,2 m/min	1,1 kg/h
	10,0 m/min	9,4 kg/h

High alloyed steel

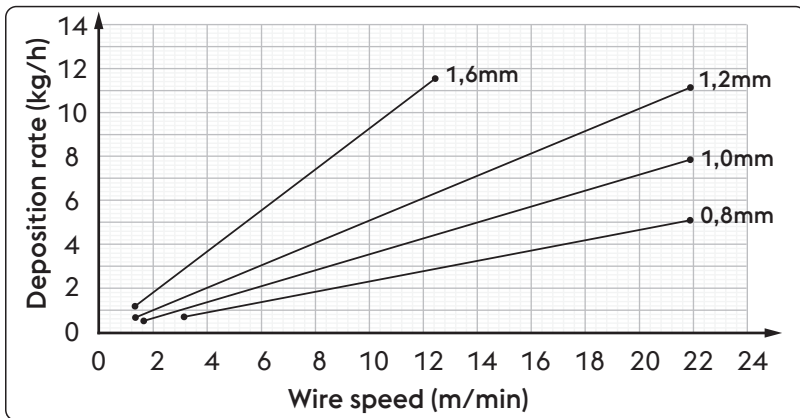

Ø	Wire speed	Deposition rate
0,8 mm	2,0 m/min	0,5 kg/h
	22,0 m/min	5,3 kg/h
1,0 mm	1,6 m/min	0,6 kg/h
	22,0 m/min	8,1 kg/h
1,2 mm	1,6 m/min	0,9 kg/h
	22,0 m/min	11,7 kg/h
1,6 mm	1,2 m/min	1,1 kg/h
	10,0 m/min	9,4 kg/h

Aluminum alloy

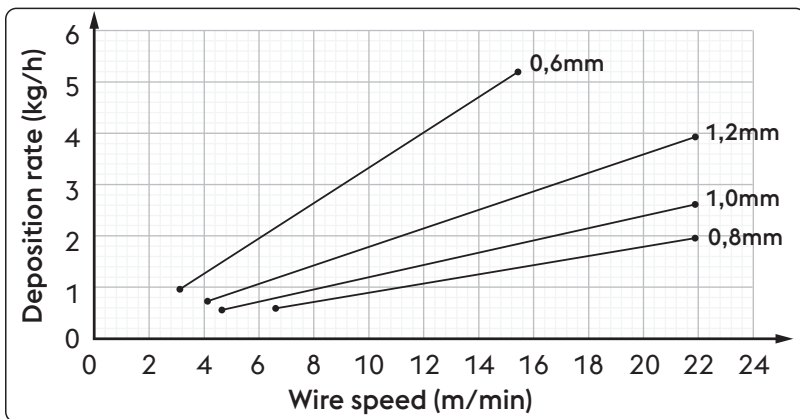

Ø	Wire speed	Deposition rate
0,8 mm	6,5 m/min	0,6 kg/h
	22,0 m/min	2,0 kg/h
1,0 mm	4,5 m/min	0,5 kg/h
	22,0 m/min	2,6 kg/h
1,2 mm	4,0 m/min	0,7 kg/h
	22,0 m/min	4,0 kg/h
1,6 mm	3,0 m/min	0,9 kg/h
	15,5 m/min	5,2 kg/h

ES

Gases utilizables

La soldadura MIG-MAG se caracteriza principalmente por el tipo de gas utilizado, inerte para la soldadura MIG (Metal Inert Gas), activo para la soldadura MAG (Metal Active Gas).

- Anhídrido carbónico (CO₂)

Si utiliza CO₂ como gas de protección se conseguirá elevadas penetraciones con elevada velocidad de avance y buenas propiedades mecánicas con un bajo coste de ejercicio. Apesar de esto, el empleo de este gas crea notables problemas sobre la composición química final de las uniones, se produce una pérdida de elementos fácilmente oxidables y se obtiene al mismo tiempo un enriquecimiento de carbono en el baño.

La soldadura con CO₂ puro también da otros tipos de problemas como la excesiva presencia de salpicaduras y la formación de porosidades de monóxido de carbono.

- Argón

Este gas inerte se utiliza puro en la soldadura de las aleaciones ligeras, mientras para la soldadura de aceros inoxidable al cromo-níquel es preferible trabajar añadiendo oxígeno y CO₂ en un porcentaje del 2%, ya que esto contribuye a la estabilidad del arco y a la mejor forma del cordón.

- Helio

Este gas se utiliza como alternativa al argón y permite mayores penetraciones (en grandes espesores) y mayores velocidades de avance.

- Mezcla Argón-Helio

Se consigue un arco más estable respecto al helio puro, además de una mayor penetración y velocidad respecto al argón.

- Mezcla Argón- CO₂ y Argón-CO₂-oxígeno

Estas mezclas se utilizan sobre todo en la soldadura de los materiales ferrosos en condiciones de el modo de funcionamiento SHORT-ARC ya que mejora el aporte térmico específico.

También pueden utilizarse en SPRAY-ARC.

Normalmente la mezcla contiene un porcentaje de CO₂ que va de las del 8% al 20% y de O₂ alrededor del 5%.

Consulte el manual del usuario del dispositivo.

Unalloyed steel / High alloyed steel		Aluminum alloy	
Gama de corriente	Flujo de gas	Gama de corriente	Flujo de gas
3-50 A	10-12 l/min	3-50 A	10-12 l/min
30-100 A	10-14 l/min	30-100 A	10-15 l/min
75-150 A	12-16 l/min	75-150 A	12-18 l/min
150-250 A	14-18 l/min	150-250 A	14-22 l/min
250-400 A	16-20 l/min	250-400 A	16-25 l/min
400-500 A	18-22 l/min	400-500 A	18-30 l/min

11. CARACTERÍSTICAS TÉCNICAS

Características del alimentador de alambre WF NX 430 SteelDrive		U.M.
Tipo de motorreductor	SL4R-4T	
Potencia motorreductor	120	W
N° de rodillos	4	
Diámetro del alambre / Rollo estándar	1.0-1.2	mm
Diámetros de los alambres/Rollos compatibles	Velocidad de avance del hilo 0.8-1.6 alambre de aluminio 1.2-2.4 alambre tubular	mm/Material
Botón de comprobación del gas	sí	
Botón de avance del alambre	sí	
Conmutador para retirar el hilo	no	
Velocidad del hilo	25 Ø 0.8 - 1.0	m/min
Sinergia	sí	
Dispositivos externos	sí (opcional)	
Conector para antorcha Push-Pull	sí (opcional)	
Diámetro de la bobina	200/300	mm
Diámetro de las ruedas delanteras	63/125 (optional)	mm
Diámetro de las ruedas traseras	63/125 (optional)	mm

Características electricas WF NX 430 SteelDrive		U.M.
Tensión de alimentación U1	48	Vdc
Tipo de comunicación	DIGITAL	
Corriente máxima absorbida I1max	4.5	A

Ciclo de trabajo WF NX 430 SteelDrive		U.M.
Ciclo de trabajo (40°C)		
(X=50%)	500	A
(X=60%)	470	A
(X=100%)	420	A
Ciclo de trabajo (25°C)		
(X=80%)	500	A
(X=100%)	470	A

Características físicas WF NX 430 SteelDrive		U.M.
Grado de protección IP	IP23S	
Dimensiones (lxwxh)	640x250x460	mm
Peso	19.0	Kg
Normas de fabricación	EN IEC 60974-5:2019 EN 60974-10/A1:2015	

ES

12. ETIQUETA DE DATOS

VOESTALPINE BÖHLER WELDING SELCO S.R.L. Via Palladio,19 - ONARA (PADOVA) - ITALY			
WF NX 430		N°	
EN 60974-5:2019 IEC 60974-10/A1:2015 Class A			
	X (40°C)	60%	100%
	I₂	500A	400A
	U₁ 48V	I_{1max} 4.5A	
IP 23 S		UK CA	
MADE IN ITALY			

ES

13. SIGNIFICADO DE LA ETIQUETA DE LOS DATOS

1		2	
3		4	
5			
	6	6A	6B
	7	7A	7B
8	9	10	
11		UK CA	
MADE IN ITALY			

- 1 Marca de fabricación
- 2 Nombre y dirección del fabricante
- 3 Modelo del aparato
- 4 N° de serie
- X **XX**XXXXXXXXXX Año de fabricación
- 5 Referencia a las normas de construcción
- 6 Símbolo del ciclo de intermitencia
- 7 Símbolo de la corriente asignada de soldadura
- 6A Valores del ciclo de intermitencia
- 6B Valores del ciclo de intermitencia
- 7A Valores de la corriente asignada de soldadura
- 7B Valores de la corriente asignada de soldadura
- 8 Símbolo de la alimentación
- 9 Tensión asignada de alimentación
- 10 Máxima corriente asignada de alimentación
- 11 Grado de protección

- CE Declaración UE de conformidad
- EAC Declaración de conformidad EAC
- UKCA Declaración de conformidad UKCA

DECLARAÇÃO DE CONFORMIDADE CE

O construtor

voestalpine Böhler Welding Selco S.r.l. - Via Palladio, 19 - 35019 Onara di Tombolo (PD) - ITALY
Tel. +39 049 9413/111 - Fax +39 049 9413/311 - www.voestalpine.com/welding

declara sob sua exclusiva responsabilidade que o seguinte produto:

WF NX 430 STEELDRIVE

71.01.083

está conforme as directivas UE:

2014/35/UE LOW VOLTAGE DIRECTIVE

2014/30/UE EMC DIRECTIVE

2011/65/UE RoHS DIRECTIVE

e que as seguintes normas harmonizadas foram aplicadas:

EN IEC 60974-5:2019

WIRE FEEDERS

EN 60974-10/A1:2015

ELECTROMAGNETIC COMPATIBILITY REQUIREMENTS

A documentação que atesta o cumprimento das diretrizes ficará à disposição para vistorias no referido fabricante.

Qualquer operação ou modificação não autorizada, previamente, pela voestalpine Böhler Welding Selco S.r.l. anulará a validade desta declaração.

Onara di Tombolo, 03/07/2023

voestalpine Böhler Welding Selco s.r.l.

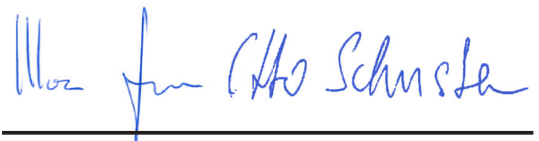

Mirco Frasson

Otto Schuster

Managing Directors

ÍNDICE GERAL

1. ATENÇÃO	195
1.1 Condições de utilização.....	195
1.2 Protecção do operador e de outros indivíduos	195
1.3 Protecção contra fumos e gases	196
1.4 Prevenção contra incêndios/explosões	196
1.5 Precauções na utilização das botijas de gás	197
1.6 Protecção contra choques eléctricos.....	197
1.7 Campos electromagnéticos e interferências	197
1.8 Grau de protecção IP	198
1.9 Descarte.....	198
2. INSTALAÇÃO.....	198
2.1 Elevação, transporte e descarga	199
2.2 Posicionamento do equipamento.....	199
2.3 Ligações.....	199
2.4 Instalação.....	199
3. APRESENTAÇÃO DO SISTEMA	201
3.1 Painel traseiro.....	201
3.2 Painel de tomadas.....	201
3.3 Painel de comandos frontal.....	202
4. UTILIZAÇÃO DO EQUIPAMENTO	203
4.1 Ecrã inicial.....	203
4.2 Ecrã de teste	203
4.3 Ecrã principal.....	203
5. DEFINIÇÕES.....	207
5.1 Definições e definição dos parâmetros	207
5.2 Procedimentos específicos de utilização dos parâmetros	216
6. ACESSÓRIOS.....	219
7. MANUTENÇÃO.....	220
7.1 Efectuar periodicamente as seguintes operações.....	220
7.2 Ansvr.....	220
8. CÓDIGOS DE ALARME.....	220
9. RESOLUÇÃO DE PROBLEMAS.....	222
10. INSTRUÇÕES OPERACIONAIS	224
10.1 Soldadura com fio contínuo (MIG/MAG).....	224
11. CARACTERÍSTICAS TÉCNICAS.....	229
12. PLACA DE DADOS.....	230
13. SIGNIFICADO DA PLACA DE DADOS	230
14. DIAGRAMA.....	459
15. CONECTORES.....	460
16. LISTA DE PEÇAS DE REPOSIÇÃO	461
17. INSTALAÇÃO KIT/ACESSÓRIOS	464

SIMBOLOS



Perigo iminente de lesões corporais graves e de comportamentos perigosos que podem provocar lesões corporais graves.



Informação importante a seguir de modo a evitar lesões menos graves ou danos em bens.



Todas as notas precedidas deste símbolo são sobretudo de carácter técnico e facilitam as operações.

1. ATENÇÃO



Antes de iniciar qualquer tipo de operação na máquina, é necessário ler cuidadosamente e compreender o conteúdo deste manual.

Não efectuar modificações ou operações de manutenção que não estejam previstas. O fabricante não se responsabiliza por danos causados em pessoas ou bens, resultantes da utilização incorrecta ou da não-aplicação do conteúdo deste manual.

Manter sempre as instruções de utilização no local de utilização do aparelho. Para além das instruções de utilização, observar as normas gerais e os regulamentos locais de prevenção de acidentes e protecção ambiental em vigor.



Todas as pessoas envolvidas na colocação em serviço, utilização, manutenção e reparação do aparelho devem:

- ser titulares de qualificação apropriada
- dispor das competências de soldadura necessárias
- ler integralmente e respeitar rigorosamente estas instruções de utilização

Para quaisquer dúvidas ou problemas relativos à utilização do equipamento, ainda que não se encontrem aqui descritos, consultar pessoal qualificado.

1.1 Condições de utilização



Cada instalação deve ser utilizada exclusivamente para as operações para que foi projectada, nos modos e nos âmbitos previstos na chapa de características e/ou neste manual, de acordo com as directivas nacionais e internacionais relativas à segurança. Uma utilização diferente da expressamente declarada pelo construtor deve ser considerada completamente inadequada e perigosa e, neste caso, o construtor declina toda e qualquer responsabilidade.



Esta máquina só deve ser utilizada com fins profissionais, numa instalação industrial. O construtor declina qualquer responsabilidade por eventuais danos provocados pela utilização da instalação em ambientes domésticos.



O equipamento deve ser utilizado em ambientes cujas temperaturas estejam compreendidas entre -10°C e +40°C (entre +14°F e +104°F).

O equipamento deve ser transportado e armazenado em ambientes cujas temperaturas estejam compreendidas entre -25°C e +55°C (entre -13°F e 131°F).

O equipamento deve ser utilizado em ambientes sem poeira, ácidos, gases ou outras substâncias corrosivas.

O equipamento deve ser utilizado em ambientes com humidade relativa não superior a 50%, a 40°C (104°F).

O equipamento deve ser utilizado em ambientes com humidade relativa não superior a 90%, a 20°C (68°F).

O equipamento deve ser utilizado a uma altitude máxima, acima do nível do mar, não superior a 2000 m (6500 pés).



Não utilizar o aparelho para descongelar tubos.

Não utilizar este equipamento para carregar baterias e/ou acumuladores.

Não utilizar este equipamento para fazer arrançar motores.

1.2 Protecção do operador e de outros indivíduos



O processo de soldadura é uma fonte nociva de radiações, ruído, calor e gases. Colocar um ecrã de protecção retardador de fogo, para proteger a área de soldadura de raios, faíscas e escórias incandescentes. Avisar todos os indivíduos nas proximidades que não devem olhar para o arco de soldadura ou metal incandescente e que devem utilizar protecção adequada.



Utilizar vestuário de protecção, para proteger a pele dos raios do arco, das faíscas ou do metal incandescente. O vestuário utilizado deve cobrir todo o corpo e deve:

- estar intacto e em bom Hóestado
- ser à prova de fogo
- ser isolante e estar seco
- estar justo ao corpo e não ter dobras



Utilizar sempre calçado conforme às normas, resistentes e que garantam isolamento contra a água.

Utilizar sempre luvas conformes às normas, que garantam isolamento eléctrico e térmico.



Usar máscaras com protectores laterais da cara e filtros de protecção adequados para os olhos (pelo menos NR10 ou superior).



Utilizar sempre óculos de protecção, com protectores laterais, especialmente durante a remoção manual ou mecânica das escórias da soldadura.



Não utilizar lentes de contacto!

PT



Utilizar protectores auriculares se, durante o processo de soldadura, forem atingidos níveis de ruído perigosos. Se o nível de ruído exceder os limites previstos pela lei, delimitar a área de trabalho e assegurar que todos os indivíduos que se encontram nas proximidades dispõem de protectores auriculares.



Durante as operações de soldadura, manter os painéis laterais sempre fechados. Os sistemas não devem ser submetidos a qualquer tipo de modificação. Evitar que mãos, cabelo, vestuário, ferramentas, etc. entrem em contacto com partes móveis, tais como: ventiladores, rodas dentadas, rolos e eixos, bobinas de fio. Não tocar nas engrenagens enquanto o mecanismo de avanço do fio estiver em funcionamento. A desactivação dos dispositivos de protecção nos mecanismos de avanço do fio é extremamente perigosa e isenta o construtor de toda e qualquer responsabilidade por eventuais danos materiais ou pessoais.



Manter a cabeça longe da tocha MIG/MAG durante o carregamento e avanço do fio. O fio em saída pode provocar danos graves nas mãos, cara e olhos.



Evitar tocar em peças acabadas de soldar, pois o elevado calor das mesmas pode causar queimaduras graves. Respeitar todas as precauções descritas anteriormente também no que diz respeito a operações posteriores à soldadura pois podem desprender-se escórias das peças que estão a arrefecer.



Verificar se a tocha arrefeceu antes de executar trabalhos ou operações de manutenção.



Assegurar que o grupo de refrigeração é desactivado, antes de desligar os tubos de alimentação e retorno do líquido de refrigeração. O líquido quente em saída pode provocar queimaduras graves.



Manter perto de si um estojo de primeiros socorros, pronto a utilizar. Não subestimar qualquer queimadura ou ferida.



Antes de abandonar o posto de trabalho, deixar a área de trabalho em boas condições de segurança, de maneira a evitar danos materiais e pessoais acidentais.

1.3 Protecção contra fumos e gases



Os fumos, gases e poeiras produzidos durante o processo de soldadura podem ser nocivos para a saúde. Os fumos produzidos durante o processo de soldadura podem, em determinadas circunstâncias, provocar cancro ou danos no feto de mulheres grávidas.

- Manter a cabeça afastada dos gases e fumos de soldadura.
- Providenciar uma ventilação adequada, natural ou artificial, da zona de trabalho.
- Caso a ventilação seja inadequada, utilizar máscaras e dispositivos respiratórios.
- No caso da operação de soldadura ser efectuada numa área extremamente reduzida, o operador deverá ser observado por um colega, que deve manter-se no exterior durante todo o processo.
- Não utilizar oxigénio para a ventilação.
- Verificar a eficiência da exaustão comparando regularmente as quantidades de emissões de gases nocivos com os valores admitidos pelas normas de segurança.
- A quantidade e a periculosidade dos fumos produzidos está ligada ao material base utilizado, ao material de adição e às eventuais substâncias utilizadas para a limpeza e desengorduramento das peças a soldar. Seguir com atenção as indicações do construtor, bem como as instruções constantes das fichas técnicas.
- Não efectuar operações de soldadura perto de zonas de desengorduramento ou de pintura.
- Colocar as botijas de gás em espaços abertos ou em locais com boa ventilação.

1.4 Prevenção contra incêndios/explosões



O processo de soldadura pode provocar incêndios e/ou explosões.

- Retirar da área de trabalho e das áreas vizinhas todos os materiais ou objectos inflamáveis ou combustíveis.
- Os materiais inflamáveis devem estar a pelo menos 11 metros (35 pés) da área de soldadura ou devem estar adequadamente protegidos.
- A projecção de faíscas e de partículas incandescentes pode atingir, facilmente, as zonas circundantes, mesmo através de pequenas aberturas. Prestar especial atenção às condições de segurança de objectos e pessoas.
- Não efectuar operações de soldadura sobre ou perto de contentores sob pressão.
- Não efectuar operações de soldadura em contentores fechados ou tubos. Prestar especial atenção à soldadura de tubos ou recipientes, ainda que esses tenham sido abertos, esvaziados e cuidadosamente limpos. Resíduos de gás, combustível, óleo ou semelhantes poderiam causar explosões.
- Não efectuar operações de soldadura em locais onde haja poeiras, gases ou vapores explosivos.

- Verificar, no fim da soldadura, que o circuito sob tensão não pode entrar em contacto, acidentalmente, com partes ligadas ao circuito de terra.
- Colocar nas proximidades da área de trabalho um equipamento ou dispositivo de combate a incêndios.

1.5 Precauções na utilização das botijas de gás



As botijas de gás inerte contêm gás sob pressão e podem explodir se não estiverem garantidas as condições mínimas de segurança de transporte, de manutenção e de utilização.

- As botijas devem estar fixas verticalmente a paredes ou outros apoios, com meios adequados, para evitar quedas e choques mecânicos acidentais.
- Enroscar o capuz para a protecção da válvula, durante o transporte, a colocação em funcionamento e sempre que se concluem as operações de soldadura.
- Evitar a exposição das botijas aos raios solares, a mudanças bruscas de temperatura ou a temperaturas demasiado altas. Não expor as botijas a temperaturas demasiado altas ou baixas.
- Evitar que as botijas entrem em contacto com chamas livres, arcos eléctricos, tochas ou alicates porta-eléctrodos e materiais incandescentes projectados pela soldadura.
- Manter as botijas afastadas dos circuitos de soldadura e dos circuitos de corrente em geral.
- Ao abrir a válvula da botija, manter a cabeça afastada do ponto de saída do gás.
- Ao terminar as operações de soldadura, deve fechar-se sempre a válvula da botija.
- Nunca efectuar soldaduras sobre uma botija de gás sob pressão.
- Nunca ligar uma botija de ar comprimido directamente ao redutor de pressão da máquina! A pressão poderia superar a capacidade do redutor que consequentemente poderia explodir!

1.6 Protecção contra choques eléctricos



Um choque de descarga eléctrica pode ser mortal.

- Evitar tocar nas zonas normalmente sob tensão, no interior ou no exterior da máquina de soldar, enquanto a própria instalação estiver alimentada (tochas, pistolas, cabos de terra, fios, rolos e bobinas estão electricamente ligados ao circuito de soldadura).
- Efectuar o isolamento eléctrico da instalação e do operador, utilizando planos e bases secos e suficientemente isolados da terra.
- Assegurar-se de que o sistema está correctamente ligado a uma tomada e a uma fonte de alimentação equipada com condutor de terra.
- Não tocar simultaneamente em duas tochas ou em dois porta-eléctrodos.
- Se sentir um choque eléctrico, interrompa de imediato as operações de soldadura.

1.7 Campos electromagnéticos e interferências



A passagem da corrente, através dos cabos internos e externos da máquina, cria um campo electromagnético nas proximidades dos cabos de soldadura e do próprio equipamento.

- Os campos electromagnéticos podem ter efeitos (até hoje desconhecidos) sobre a saúde de quem está sujeito a exposição prolongada.
- Os campos electromagnéticos podem interferir com outros equipamentos tais como “pacemakers” ou aparelhos auditivos.



Os portadores de aparelhos electrónicos vitais (“pacemakers”) devem consultar o médico antes de procederem a operações de soldadura por arco.

1.7.1 Classificação CEM em conformidade com a norma: EN 60974-10/A1:2015.

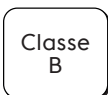

O equipamento Classe B cumpre os requisitos de compatibilidade electromagnética em ambientes industriais e residenciais, incluindo zonas residenciais em que o fornecimento de energia eléctrica é efectuado pela rede pública de baixa tensão.

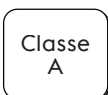

O equipamento Classe A não deve ser utilizado em zonas residenciais em que o fornecimento de energia eléctrica é efectuado pela rede pública de baixa tensão. Dado que eventuais perturbações de condutividade e radiação poderão dificultar a compatibilidade electromagnética do equipamento classe A nessas zonas.

Para mais informações, consulte o capítulo: PLACA DE DADOS ou Características técnicas.

1.7.2 Instalação, utilização e estudo da área

Este equipamento foi construído em conformidade com as indicações contidas na norma harmonizada EN 60974-10/A1:2015 e está identificado como pertencente à “CLASSE A”. Esta máquina só deve ser utilizada com fins profissionais, numa instalação industrial. O construtor declina qualquer responsabilidade por eventuais danos provocados pela utilização da instalação em ambientes domésticos.



O utilizador deve ser especializado na actividade, sendo, por isso, responsável pela instalação e pela utilização do equipamento de acordo com as indicações do fabricante. Caso se detectem perturbações electromagnéticas, o operador do equipamento terá de resolver o problema, se necessário em conjunto com a assistência técnica do fabricante.



As perturbações electromagnéticas têm sempre que ser reduzidas até deixarem de constituir um problema.



Antes de instalar este equipamento, o utilizador deverá avaliar potenciais problemas electromagnéticos que poderão ocorrer nas zonas circundantes e, particularmente, os relativos às condições de saúde das pessoas expostas, por exemplo, das pessoas que possuam “pacemakers” ou aparelhos auditivos.

1.7.3 Precauções relacionadas com os cabos

Para minimizar os efeitos dos campos electromagnéticos, respeitar as seguintes instruções:

- Enrolar juntos e fixar, quando possível, o cabo de terra e o cabo de potência.
- Evitar enrolar os cabos à volta do corpo.
- Evitar colocar-se entre o cabo de terra e o cabo de potência (manter os dois cabos do mesmo lado).
- Os cabos deverão ser mantidos tão curtos quanto possível, colocados juntos entre si e mantidos ao nível do chão.
- Colocar o equipamento a uma certa distância da zona de soldadura.
- Os cabos devem ser colocados longe de outros cabos eventualmente presentes.

1.7.4 Ligação à terra

Deve ter-se em consideração que todos os componentes metálicos da instalação de soldadura e dos que se encontram nas suas proximidades devem ser ligados à terra. A ligação à terra deverá ser feita de acordo com as normas nacionais.

1.7.5 Ligação da peça de trabalho à terra

Quando a peça de trabalho não está ligada à terra, por razões de segurança eléctrica ou devido às suas dimensões e posição, uma ligação entre a peça e a terra poderá reduzir as emissões. É necessário ter em consideração que a ligação à terra da peça de trabalho não aumenta o risco de acidente para o operador nem danifica outros equipamentos eléctricos. A ligação à terra deverá ser feita de acordo com as normas nacionais.

1.7.6 Blindagem

A blindagem selectiva de outros cabos e equipamentos presentes na zona circundante pode reduzir os problemas provocados por interferência electromagnética.

A blindagem de toda a máquina de soldar pode ser ponderada para aplicações especiais.

1.8 Grau de protecção IP



IP23S

- Invólucro protegido contra o acesso de dedos a partes perigosas e contra objectos sólidos com diâmetro superior/ igual a 12,5 mm.
- Invólucro protegido contra chuva que caia num ângulo até 60°.
- Invólucro protegido contra os efeitos danosos devidos à entrada de água, quando as partes móveis do equipamento não estão em movimento.

1.9 Descarte



Não eliminar o equipamento eléctrico juntamente com o lixo comum!

Em conformidade com a Diretiva Europeia 2012/19/UE relativa aos Resíduos de Equipamentos Eléctricos e Electrónicos e a sua aplicação de acordo com a legislação nacional, os equipamentos eléctricos que tenham atingido o fim do seu ciclo de vida devem ser recolhidos separadamente e enviados para um centro de valorização e eliminação. Cabe ao proprietário do equipamento identificar os centros de recolha autorizados, solicitando informações às autoridades locais. A aplicação da Diretiva Europeia irá permitir melhorar o ambiente e a saúde humana.

» Para mais informações, consultar o site na internet.

2. INSTALAÇÃO



A instalação só pode ser executada por pessoal experiente e autorizado pelo fabricante.



Para executar a instalação, assegurar-se de que o gerador está desligado da rede de alimentação.

2.1 Elevação, transporte e descarga

- O equipamento é fornecido com uma pega, para transporte à mão.
- O equipamento não dispõe de elementos específicos para elevação.
- Utilizar um empilhador, prestando a maior atenção durante a deslocação, para evitar a queda do gerador.



Nunca subestimar o peso do equipamento, (ver características técnicas).
Nunca deslocar, ou posicionar, a carga suspensa sobre pessoas ou bens.
Não deixar cair o equipamento, nem exercer pressão desnecessária sobre ele.

2.2 Posicionamento do equipamento



Observar as seguintes regras:

- Fácil acesso aos comandos e ligações do equipamento.
- Não colocar o equipamento em espaços reduzidos.
- Nunca colocar o equipamento num plano com inclinação superior a 10° em relação ao plano horizontal.
- Ligar o equipamento num lugar seco, limpo e com ventilação apropriada.
- Proteger o equipamento da chuva e do sol.

2.3 Ligações





As unidades móveis são alimentadas exclusivamente com baixa tensão.

2.4 Instalação

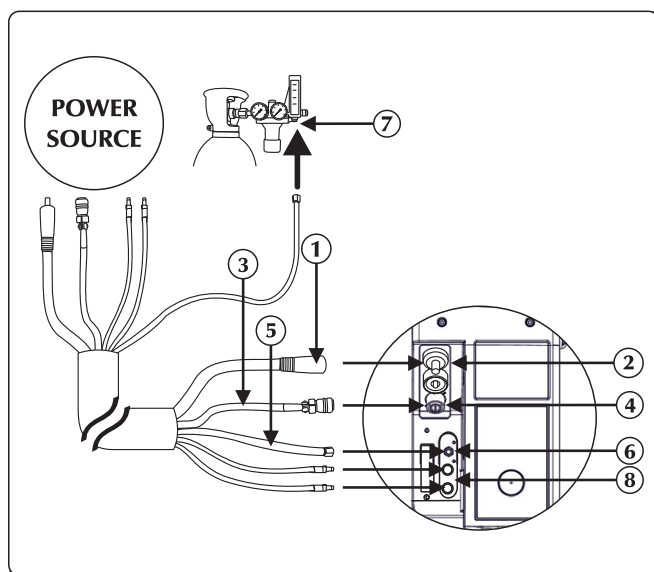
2.4.1 Ligação para a soldadura MIG/MAG



- ① Cabo de alimentação
- ② Tomada positiva de potência (+)
- ③ Cabo de sinal
- ④ Entrada cabo de sinal
- ⑤ Tubo de gás de tocha
- ⑥ União/ligação de gás
- ⑦ Ligação da alimentação de gás
- ⑧ Ligação de líquido de refrigeração

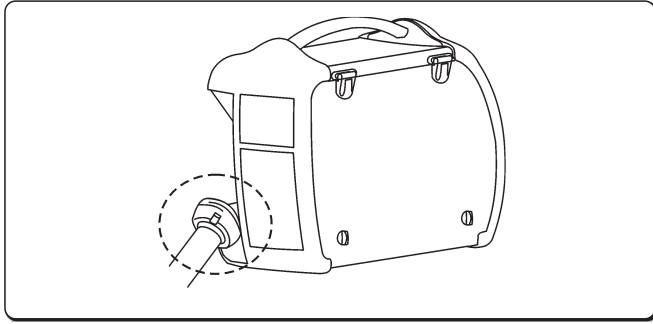

- ▶ Ligar o cabo de alimentação à saída específica. Inserir a ficha e rodar no sentido dos ponteiros do relógio até fixar.
- ▶ Ligar o cabo de sinal ao conector específico. Inserir o conector e rodar a porca no sentido dos ponteiros do relógio até fixar.
- ▶ Ligar o tubo de gás à válvula redutora de pressão da botija ou à ligação de alimentação do gás. Regular o fluxo do gás de 10 a 30 l/min.
- ▶ Ligar o tubo de água (azul escuro) ao conector rápido de saída (azul escuro ) da unidade de refrigeração.
- ▶ Ligar o tubo de água (vermelho) ao conector rápido de entrada (vermelho ) da unidade de refrigeração.
- ▶ Ligar o cabo de sinal CAN-BUS, para o controlo de dispositivos externos (como RC, RI, etc.), ao conector específico.

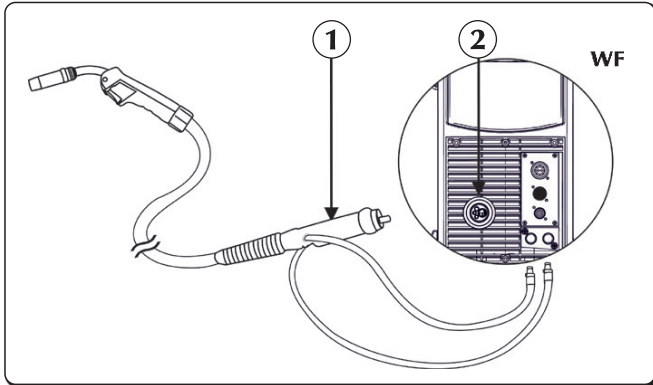

Consulte a secção “Instalação/acessórios”.



- ① Conexão da tocha
- ② Conectore

- ▶ Ligar o tubo de água da tocha (vermelho) ao conector rápido de entrada da unidade (vermelho ) de refrigeração.
- ▶ Ligar o tubo de água da tocha (azul escuro ) ao conector rápido de saída da unidade de refrigeração.
- ▶ Ligar a tocha MIG/MAG ao adaptador central, tendo o cuidado de aparafusar completamente o anel de fixação.

PT

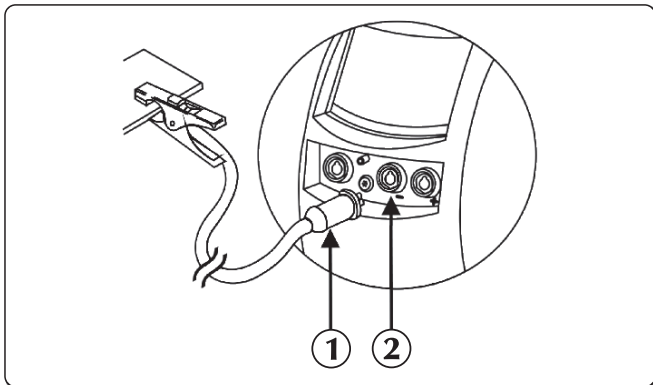

- ① Conector de pinça de ligação à terra
- ② Tomada negativa de potência (-)

- ▶ Ligar o grampo de massa à tomada negativa (-) da fonte de alimentação. Inserir a ficha e rodar no sentido dos ponteiros do relógio até fixar.

Compartmento do motor

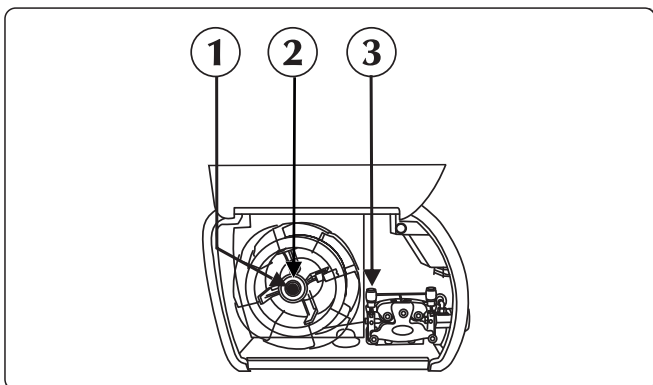

- ① Porca
- ② Parafuso de fricção
- ③ Suporte de arrastamento do mecanismo de avanço de fio

- ▶ Abrir a tampa lateral direita.
- ▶ Verificar se a gola do rolo coincide com o diâmetro do fio que se pretende utilizar.
- ▶ Desaparafusar a porca do eixo e inserir o porta-bobina.

- ▶ Fazer entrar no alojamento também o pivô do porta-bobina, voltar a colocar a porca na sua posição e regular o parafuso de fricção.
- ▶ Desbloquear o suporte de arrastamento do mecanismo de avanço de fio introduzindo a extremidade do fio no casquilho guia fio e, fazendo-o passar sobre o rolo, na conexão da tocha. Bloquear na posição o suporte de avanço, verificando se o fio foi introduzido na gola dos rolos.
- ▶ Pressionar o botão de avanço fio para carregar o fio na tocha.
- ▶ Regular o fluxo do gás de 10 a 30 l/min.

3. APRESENTAÇÃO DO SISTEMA

3.1 Painel traseiro

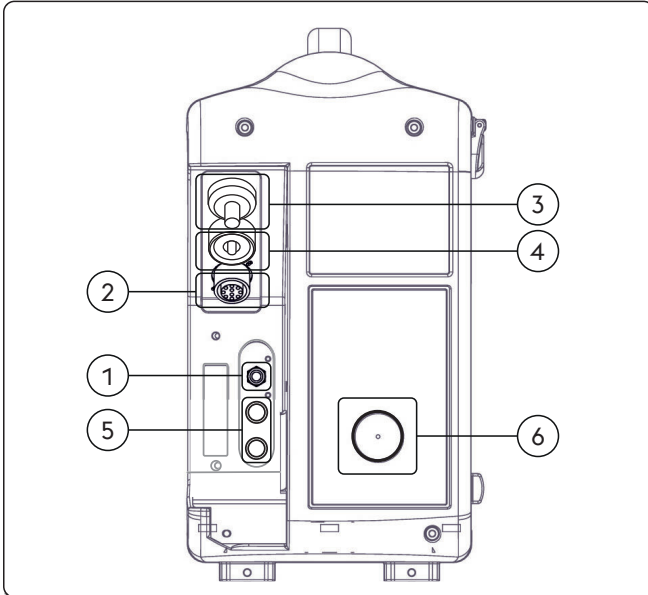

- ① Conexão do gás
- ② Entrada para cabo de sinal (CAN-BUS) (feixe de cabos)
- ③ Entrada para cabo de potência (feixe de cabos)
- ④ Tomada positiva de potência (+)
- ⑤ Entrada/Saída de líquido de refrigeração
- ⑥ Entrada do fio



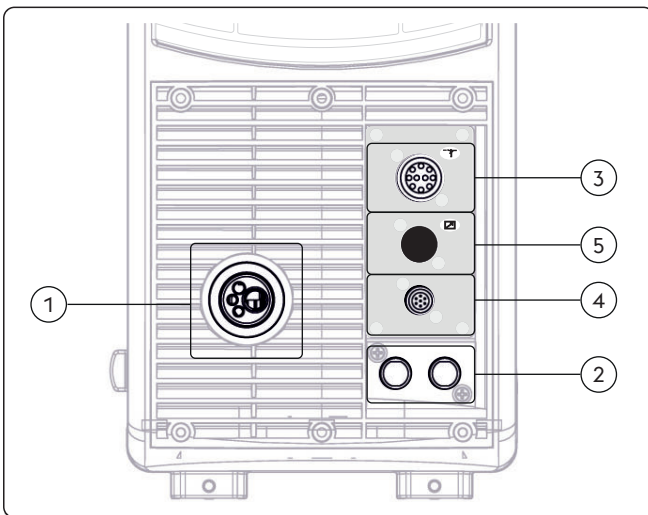



3.2 Painel de tomadas

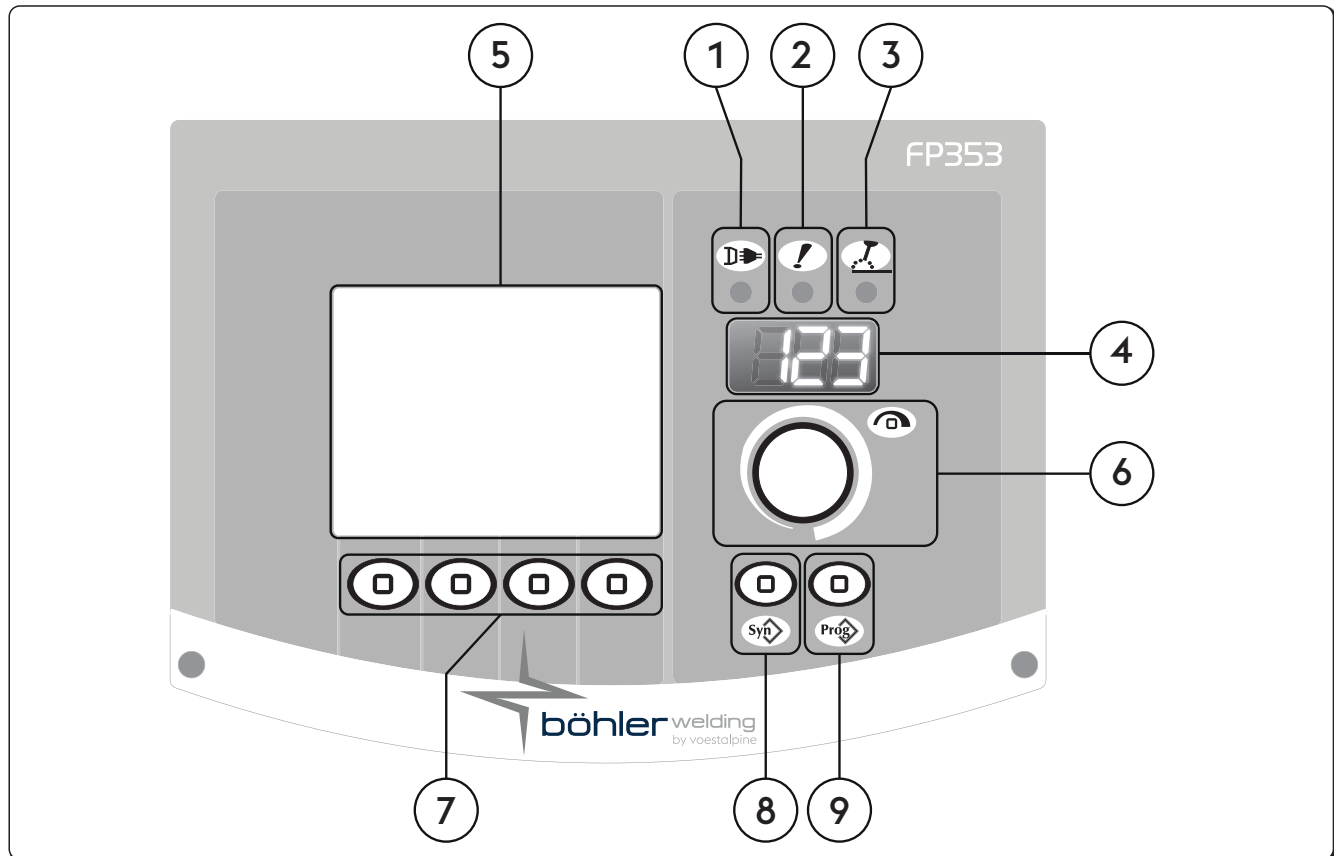

- ① Conexão da tocha
Permite a ligação da tocha MIG/MAG.
- ② Ligação de líquido de refrigeração
- ③ Entrada cabo de sinal (Push-Pull)
- ④ Entrada cabo de sinal (tocha)
Ligação do lança-chamas
- ⑤ Entrada de cabo de sinal (RC)

3.3 Painel de comandos frontal



- ①  **LED de alimentação**
Indica que o equipamento está ligado à fonte de alimentação e se encontra activo.
- ②  **LED de alarme geral**
Indica a eventual intervenção de dispositivos de protecção, como a protecção de temperatura.
- ③  **LED de potência activa**
Indica a presença de potência nas ligações de saída do equipamento.
- ④  **Visor de 7 segmentos**
Permite que sejam apresentados os parâmetros gerais da máquina de soldar, durante a inicialização, a definição, a leitura da corrente e da potência, bem como durante a soldadura e codificação dos alarmes.
- ⑤  **Visor LCD**
Permite que sejam apresentados os parâmetros gerais da máquina de soldar, durante a inicialização, a definição, a leitura da corrente e da potência, bem como durante a soldadura e codificação dos alarmes. Permite que todas as operações sejam apresentadas instantaneamente.
- ⑥  **Manípulo de regulação principal**
Permite a acesso à configuração, selecção e definição dos parâmetros de soldadura.
- ⑦  **Teclas de função**
Permite seleccionar as diversas funções do sistema:

 - Processo de soldadura
 - Métodos de soldadura
 - Pulsação de corrente
 - Modo gráfico

8 Teclas de programas de soldadura

Permite seleccionar um programa de soldadura predefinido, escolhendo algumas definições simples:

- Tipo de fio
- Tipo de gás
- Diâmetro do fio

9 Botão job

4. UTILIZAÇÃO DO EQUIPAMENTO

4.1 Ecrã inicial

Ao ser ligado, o gerador executa uma série de verificações, para garantir que o sistema e todos os dispositivos que lhe estão ligados funcionam correctamente. Nesta fase, o teste de gás também é executado para verificar a correcta ligação ao sistema de alimentação de gás.

4.2 Ecrã de teste

Enquanto o painel lateral (compartimento da bobina) estiver aberto, as operações de soldadura estão inibidas. O ecrã de teste afixa-se no visor LCD.

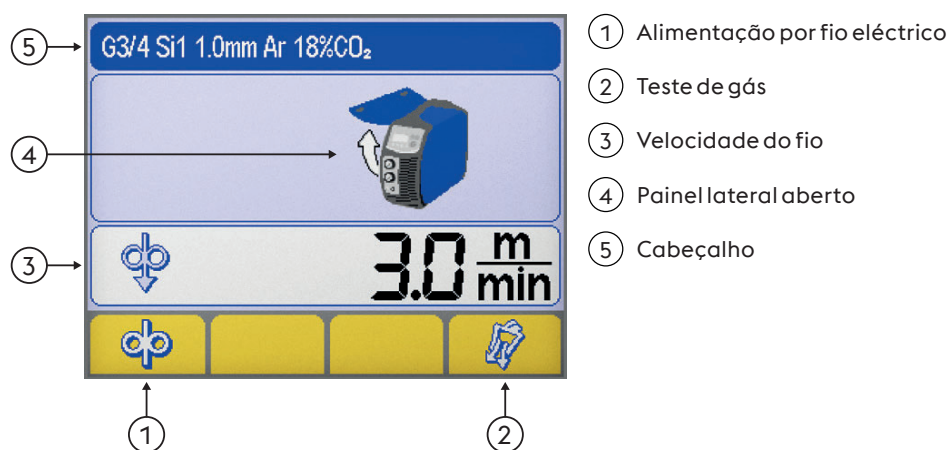

Alimentação por fio eléctrico

Permite o avanço manual do fio na ausência do fluxo de gás e de alimentação eléctrica. Permite que o fio seja introduzido na bainha da tocha durante as fases de preparação da soldadura.



Teste de gás

Permite que o circuito de gás seja limpo de impurezas, bem como a obtenção da pressão de gás preliminar adequada e a realização de ajustes do fluxo, sem potência de saída.



Velocidade do fio

Permite a regulação da velocidade de avanço do fio (durante a fase de carregamento).

Mínimo	Máximo	Predefinido
0.5 m/min	22.0 m/min	3.0 m/min



Painel lateral aberto



Cabeçalho

Permite a apresentação de determinados elementos de informação importantes, relativos ao processo seleccionado.

4.3 Ecrã principal

Permite o controlo do sistema e do processo de soldadura, apresentando as definições principais.

PT

4.4 MIG/MAG folyamat főképernyő

Ecrã de base

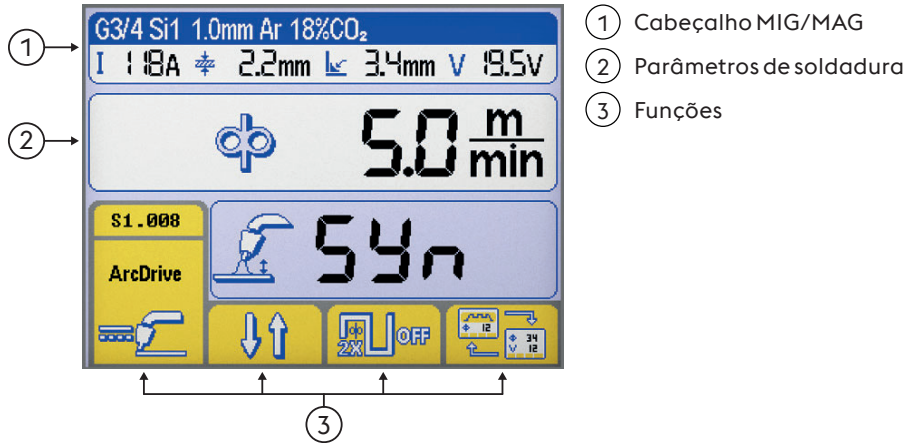

Ecrã gráfico

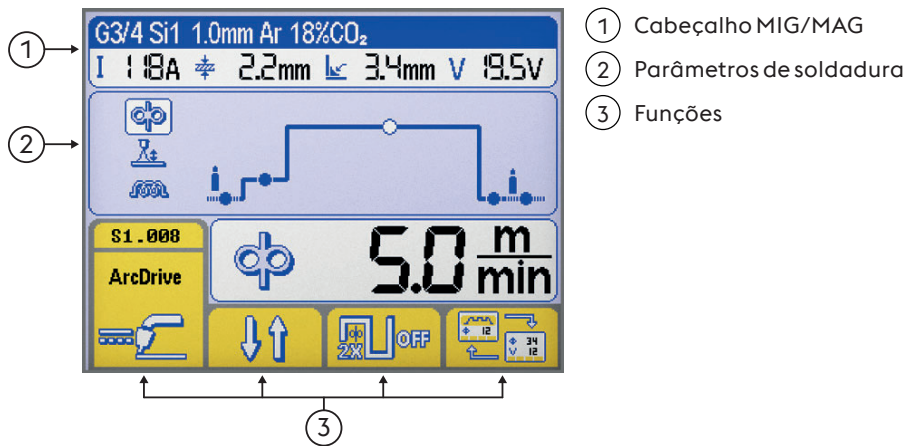

PT

Cabeçalho MIG/MAG

Permite a apresentação de determinados elementos de informação importantes, relativos ao processo seleccionado.

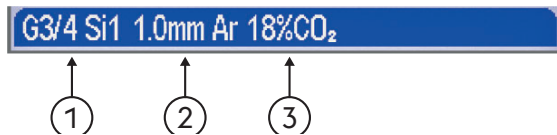

Curva sinérgica seleccionada

- ① Tipo de material de adição
- ② Diâmetro do fio
- ③ Tipo de gás

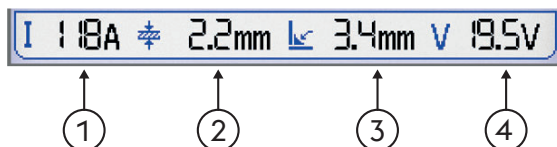

Parâmetros de soldadura

- ① Corrente de soldadura
- ② Espessura da peça de trabalho
- ③ Cordão de canto "a"
- ④ Tensão de soldadura

Parâmetros de soldadura (Ecrã de base)

► Premir a tecla de codificação ("encoder"), para seleccionar o parâmetro pretendido.

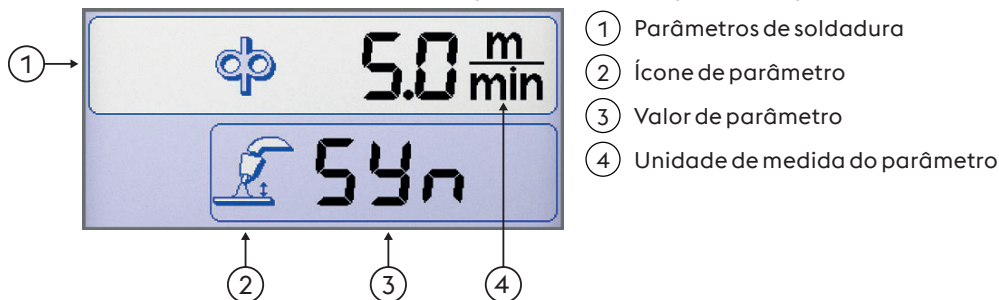

Parâmetros de soldadura (Ecrã gráfico)

► Premir a tecla de codificação (“encoder”), para seleccionar o parâmetro pretendido.

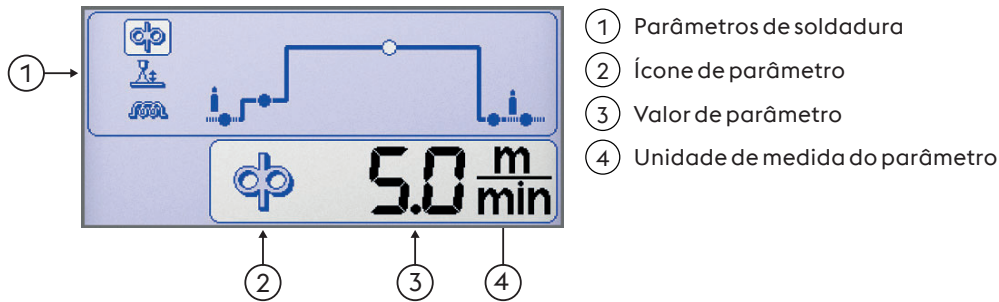

Funções

Permite a definição das funções de processo e métodos de soldadura mais importantes.

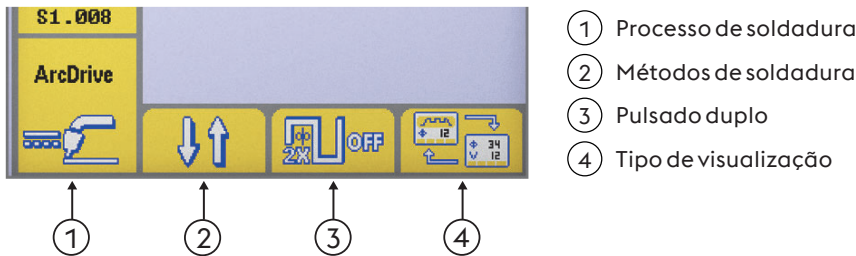

Métodos de soldadura

Permite a selecção do método de soldadura



2 Fases

Em duas fases, carregar no botão provoca o fluxo de gás, alimenta potência ao fio e fá-lo avançar; ao ser solto, o gás, a potência e o avanço de fio são desligados.



4 Fases

Em quatro fases, a primeira vez que se carrega no botão provoca o fluxo de gás, executando o período de pré-gás manual; quando é solto, activa a potência no fio e o mecanismo de avanço de fio. A segunda vez que se carrega no botão faz parar o fio e provoca o início do processo final, o que repõe a corrente a zero; no final, quando o botão é solto, o fluxo de gás é desactivado.



Crater filler

Permite que a soldadura seja feita com três tipos diferentes de potência, com a capacidade de serem directamente seleccionados e controlados pelo soldador, através do botão da tocha.

A primeira vez que se carrega no botão provoca o fluxo de gás, activa a potência no fio e fá-lo avançar à velocidade definida pelo parâmetro “incremento inicial” (durante a configuração), com os valores sinérgicos relativos dos parâmetros de soldadura.

Quando o botão da tocha é solto, a velocidade do fio e os parâmetros sinérgicos relativos são alterados automaticamente para os valores principais, definidos no painel de controlo.

Quando se carrega novamente no botão da tocha, a velocidade do fio e os parâmetros sinérgicos relativos são repostos nos valores predefinidos de parâmetro de enchimento de cratera (durante a configuração).

Soltar o botão da tocha desactiva o avanço do fio e fornece a alimentação para as fases de “burnback” e pós-gás.



Pulsado duplo



Pulsado duplo activo



Pulsado duplo inactivo



Tipo de visualização

Permite alternar as visualizações entre:



Ecrã de base



Ecrã gráfico

Ecrã de curvas sinérgicas

Sinergia





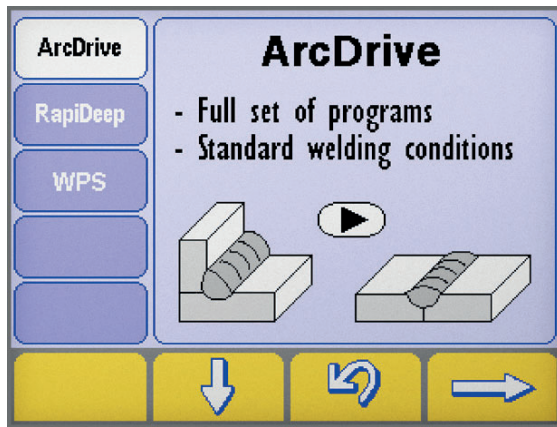

Permite seleccionar um programa de soldadura predefinido (sinergia), escolhendo algumas definições simples

PT

Seleção do processo de soldadura



- ▶ Entrar no ecrã "sinergias" premindo o botão  durante, pelo menos, um segundo.
- ▶ Selecionar o processo desejado premindo os botões  e .
- ▶ Premir o botão  para avançar para o passo seguinte.



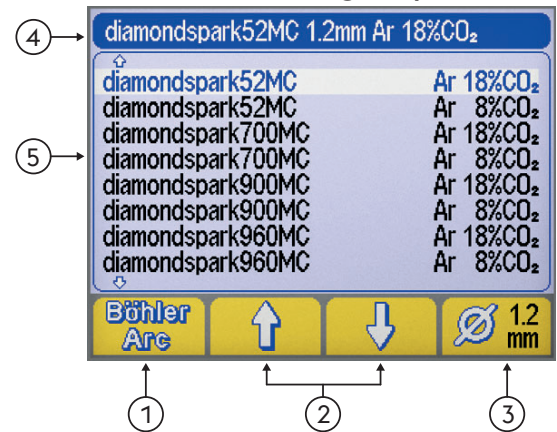

Ecrã de seleção de sinergia Tipo de material/Tipo de gás



- 1 Programa de soldadura (BöhlerArc/UniversalArc)
- 2 Seleção de material/gás
- 3 Diâmetro do fio
- 4 Cabeçalho
- 5 Programa de soldadura

PT

Böhler Arc Programa de soldadura
Permite a selecção do programa de soldadura

 BöhlerArc  UniversalArc

 Seleção de material/gás
Permite seleccionar:

- Tipo de material de adição
- Tipo de gás

 Diâmetro do fio
Permite a selecção do diâmetro do fio utilizado (mm).



- 1 Diâmetro do fio

1

Cabeçalho

Permite a apresentação de determinados elementos de informação importantes, relativos ao processo seleccionado.

NO PROGRAM (sem programa)

Indica que o programa sinérgico seleccionado não está disponível ou não é consistente com as restantes definições do sistema.

5. DEFINIÇÕES

5.1 Definições e definição dos parâmetros

Permite a definição e a regulação de uma série de parâmetros adicionais para um controlo melhorado e mais preciso do sistema de soldadura.

Os parâmetros presentes nas definições estão organizados em função do processo de soldadura seleccionado e possuem um código numérico.

Acesso a definições



- ▶ Carregar durante 5 segundos no botão encoder.
- ▶ A introdução será confirmada pela inscrição 0 que surge no visor.

Seleção e regulação do parâmetro desejado

- ▶ Rodar a tecla de codificação (“encoder”) até visualizar o código numérico relativo ao parâmetro.
- ▶ Neste momento, carregar na tecla de codificação permite a visualização do valor definido para o parâmetro seleccionado e a respectiva regulação.

Saída de definições

- ▶ Para sair da secção “regulação” premir novamente a tecla de codificação.
- ▶ Para sair de definições, aceder ao parâmetro “0” (guardar e sair) e premir a tecla de codificação.
- ▶ Carregar no botão, para confirmar a operação
- ▶ Para guardar a alteração e sair da configuração, premir o botão:

5.1.1 Lista dos parâmetros de definições (MMA)

0
Guardar e sair

Permite guardar as modificações e sair de definições.

1
Reset

Permite redefinir todos os parâmetros para os valores predefinidos.

3
Hot start

Permite regular o valor de “hot start” em MMA.

Permite um início mais ou menos quente nas fases de ignição do arco, facilitando as operações iniciais.

Eléctrodo básico

Mínimo	Máximo	Predefinido
0/off	500%	80%

Eléctrodo celulósico

Mínimo	Máximo	Predefinido
0/off	500%	150%

Eléctrodo CrNi

Mínimo	Máximo	Predefinido
0/off	500%	100%

Eléctrodo de alumínio

Mínimo	Máximo	Predefinido
0/off	500%	120%

Eléctrodo de ferro fundido

Mínimo	Máximo	Predefinido
0/off	500%	100%

7**Corrente de soldadura**

Permite regular a corrente de soldadura.



Mínimo	Máximo	Predefinido
3 A	I _{max}	100 A

8**Arc force**

Permite regular o valor do "Arc force" em MMA.

Permite uma resposta dinâmica mais ou menos energética em soldadura, facilitando as operações realizadas pelo soldador.



Aumentar o valor da força do arco para reduzir o risco de colagem do eléctrodo.

Eléctrodo básico

Mínimo	Máximo	Predefinido
0/off	500%	30%

Eléctrodo celulósico

Mínimo	Máximo	Predefinido
0/off	500%	350%

Eléctrodo CrNi

Mínimo	Máximo	Predefinido
0/off	500%	30%

Eléctrodo de alumínio

Mínimo	Máximo	Predefinido
0/off	500%	100%

Eléctrodo de ferro fundido

Mínimo	Máximo	Predefinido
0/off	500%	70%

204**Dynamic power control (DPC)**

Permite seleccionar a característica V/I pretendida.

**I=C Corrente constante**

O aumento ou redução da altura do arco não tem efeito na corrente de soldadura necessária.

Recomendado para eletrodo: Básico, Rutílico, Ácido, Aço, Ferro fundido

1:20 Diminuição do controlo de gradiente

O aumento da altura do arco provoca uma redução da corrente de soldadura (e vice-versa), de acordo com o valor determinado por 1 para 20 amperes por volt.

Recomendado para eletrodo: Celulósico, Alumínio

P=C Potência constanteO aumento da altura do arco provoca uma redução da corrente de soldadura (e vice-versa), de acordo com a lei: $V \cdot I = K$

Recomendado para eletrodo: Celulósico, Alumínio

312**Tensão de extinção do arco**

Permite definir o valor de tensão que, ao ser atingido, força a extinção do arco eléctrico.

Permite uma melhor gestão das várias condições de funcionamento ocorridas.

Na fase de soldadura por pontos, por exemplo, uma baixa tensão de extinção do arco possibilita uma menor produção de chama no afastamento do eléctrodo da peça reduzindo salpicos, queimaduras e oxidação da peça.

No caso da utilização de eléctrodos que necessitam de altas tensões é aconselhável, pelo contrário, definir um limite alto, para evitar que o arco se extinga durante a soldadura.

*Nunca definir uma tensão de extinção do arco maior do que a tensão em vazio do gerador.***Eléctrodo básico**

Mínimo	Máximo	Predefinido
0/off	99.9 V	57.0 V

Eléctrodo celulósico

Mínimo	Máximo	Predefinido
0/off	99.9 V	70.0 V

399**Velocidade de corte**

Permite definir a velocidade de soldadura.

Default cm/min: velocidade de referência para soldadura manual.

Syn: valor sinérgica.



Mínimo	Máximo	Predefinido
1 cm/min	200 cm/min	15 cm/min

500 Configuração da máquina

Permite seleccionar a interface gráfica pretendida.
Permite aceder aos níveis de definição superiores.
Consultar a secção "Personalização da interface (Set up 500)"

Valor	Interface do Utilizador	Valor	Nível seleccionado
XE	Modo Básico	USER	Utilizador
XA	Modo Avançado	SERV	Service
XP	Modo Profissional	vaBW	vaBW

551 Lock/unlock

Permite o bloqueio dos controlos do painel e a introdução de um código de protecção.
Consultar a secção "Lock/unlock (Set up 551)".

552 Tom avisador sonoro

Permite a regulação do tom avisador sonoro.

Mínimo	Máximo	Predefinido
0/off	10	10

601 Passo de regulação

Permite a regulação de um parâmetro, com um passo que pode ser personalizado pelo operador.

Mínimo	Máximo	Predefinido
1	Imax	1

602 Parâmetro externo CH1, CH2, CH3, CH4

Permite a gestão do parâmetro externo 1, 2, 3, 4 (valor mínimo, valor máximo, valor predefinido, parâmetro seleccionado).

Consultar a secção "Gestão de controlos externos (Set up 602)".

705 Calibração da resistência do circuito

Permite calibrar o equipamento.

Consultar a secção "Calibração da resistência do circuito (set up 705)".

751 Leitura de corrente

Permite a apresentação do valor real da corrente de soldadura.

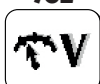
752 Leitura de tensão

Permite a apresentação do valor real da tensão de soldadura.

768 Medição da aportação de calor HI

Permite ler o valor medido da aportação de calor durante a soldadura.

801 Limites de segurança

Permite a definição dos limites de aviso e dos limites de segurança.

Permite o controlo do processo de soldadura, através da definição de limites de aviso e limites de segurança, aplicáveis aos principais parâmetros mensuráveis.

Permite o controlo preciso das várias fases de soldadura.

Consultar a secção "Limites de segurança (Set up 801)".

5.1.2 Lista de parâmetros na configuração (TIG)
0 Guardar e sair

Permite guardar as modificações e sair de definições.

PT

1 Reset

Permite redefinir todos os parâmetros para os valores predefinidos.

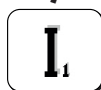
7 Corrente de soldadura

Permite regular a corrente de soldadura.

Mínimo	Máximo	Predefinido
3 A	I _{max}	100 A

399 Velocidade de corte

Permite definir a velocidade de soldadura.

Default cm/min: velocidade de referência para soldadura manual.

Syn: valor sinérgica.

Mínimo	Máximo	Predefinido
1 cm/min	200 cm/min	10 cm/min

500 Configuração da máquina

Permite seleccionar a interface gráfica pretendida.

Permite aceder aos níveis de definição superiores.

Consultar a secção "Personalização da interface (Set up 500)"

Valor	Interface do Utilizador	Valor	Nível seleccionado
XE	Modo Básico	USER	Utilizador
XA	Modo Avançado	SERV	Service
XP	Modo Profissional	vaBW	vaBW

551 Lock/unlock

Permite o bloqueio dos controlos do painel e a introdução de um código de protecção.

Consultar a secção "Lock/unlock (Set up 551)".

552 Tom avisador sonoro

Permite a regulação do tom avisador sonoro.

Mínimo	Máximo	Predefinido
0/off	10	10

601 Passo de regulação

Permite a regulação de um parâmetro, com um passo que pode ser personalizado pelo operador.

Mínimo	Máximo	Predefinido
1	I _{max}	1

602 Parâmetro externo CH1, CH2, CH3, CH4

Permite a gestão do parâmetro externo 1, 2, 3, 4 (valor mínimo, valor máximo, valor predefinido, parâmetro seleccionado).

Consultar a secção "Gestão de controlos externos (Set up 602)".

705 Calibração da resistência do circuito

Permite calibrar o equipamento.

Consultar a secção "Calibração da resistência do circuito (set up 705)".

751 Leitura de corrente

Permite a apresentação do valor real da corrente de soldadura.

752 Leitura de tensão

Permite a apresentação do valor real da tensão de soldadura.

758 Velocidade de movimentação de robô

Permite a apresentação da velocidade de movimentação de um braço robotizado ou automatizado.

768 Medição da aportação de calor HI

Permite ler o valor medido da aportação de calor durante a soldadura.

801 Limites de segurança

Permite a definição dos limites de aviso e dos limites de segurança.

Permite o controlo do processo de soldadura, através da definição de limites de aviso e limites de segurança, aplicáveis aos principais parâmetros mensuráveis.

Permite o controlo preciso das várias fases de soldadura.

Consultar a secção "Limites de segurança (Set up 801)".

5.1.3 Lista de parâmetros na configuração (MIG/MAG)
0 Guardar e sair

Permite guardar as modificações e sair de definições.

1 Reset

Permite redefinir todos os parâmetros para os valores predefinidos.

2 Programas de soldadura

MIG/MAG Padrão:

Permite a selecção do processo MIG manual () ou MIG sinérgico () , através da definição do tipo de material a soldar.

MIG/MAG Pulsado:

Permite a selecção do processo MIG sinérgico () , através da definição do tipo de material a soldar.
Permite a selecção do processo CC/CV.

3 Velocidade do fio

Permite a regulação da velocidade de avanço do fio.

Mínimo	Máximo	Predefinido
0.5 m/min	22.0 m/min	-

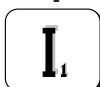
4 Corrente

Permite regular a corrente de soldadura.

Mínimo	Máximo
3 A	I _{max}

5 Espessura da peça de trabalho

Permite a definição da espessura da peça a soldar.

Possibilita a definição do sistema através da regulação da peça a ser soldada.

6 Cordão de canto "a"

Permite definir a profundidade do cordão de soldadura numa junta de canto.

10 Pré-gás

Permite definir e regular o fluxo de gás antes da ignição do arco.

Permite o carregamento do gás na tocha e a preparação do ambiente para a soldadura.

Mínimo	Máximo	Predefinido
0/off	99.9 s	0.1 s

PT

11 Soft start

Permite a regulação da velocidade de avanço do fio nas fases que antecedem a ignição.
Permite uma ignição a velocidade reduzida, mais suave e com menos salpicos.

Mínimo	Máximo	Predefinido
10 %	100 %	50 %

12 Rampa motor

Permite definir uma passagem gradual entre a velocidade do fio de ignição e a velocidade do fio de soldadura.

Mínimo	Máximo	Predefinido
0/off	1.0 s	0/off

15 Burn back

Permite a regulação do tempo de queima do fio, impedindo a colagem no fim da soldadura.
Permite regular o comprimento do pedaço de fio exterior à tocha.

Mínimo	Máximo	Predefinido
-2.00	+2.00	0/syn

16 Pós-gás

Permite regular o fluxo de gás no fim da soldadura.

Mínimo	Máximo	Predefinido
0/off	99.9 s	2.0 s

19 Duty cycle (duplo impulso)

Permite o ajuste do ciclo de trabalho em duplo impulso.

Mínimo	Máximo	Predefinido
10 %	90 %	50 %

20 Pulsado duplo

Permite a regulação da amplitude de pulsação.

Mínimo	Máximo	Predefinido
0 %	100 %	±25 %
Mínimo	Máximo	Predefinido
0.5 m/min	22 m/min	2.5 m/min

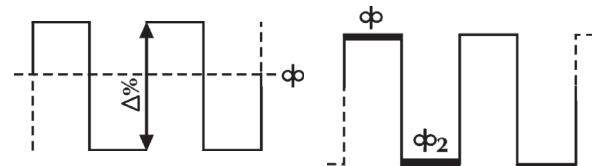
**21 Frequência de pulsação (duplo impulso)**

Permite a regulação do ciclo, isto é, do ciclo de repetição do impulso.
Permite a regulação da frequência do impulso.

Mínimo	Máximo	Predefinido
0.1 Hz	5.0 Hz	2.0 Hz

22 Tensão secundária (duplo impulso)

Permite a regulação da tensão do nível de pulsação secundário.
Possibilita a obtenção de uma maior estabilidade do arco, durante as várias fases de pulsação.

Mínimo	Máximo	Predefinido
-5.0	+5.0	0/syn

23 Declives de pulsação (duplo impulso)

Permite definir um tempo de declive, durante a operação de pulsação.

Mínimo	Máximo	Predefinido
1 %	100 %	50 %

24 Bilevel (4T - crater filler)

Permite regular a velocidade do fio secundária na modalidade de soldadura de duplo nível.

Se o soldador pressiona e solta rapidamente o botão passa-se a “ ϕ_2 ”.

Pressionando e soltando rapidamente o botão passa-se novamente a “ ϕ ” e assim adiante.

Mínimo	Máximo	Predefinido
1 %	200 %	0/off

25 Incremento inicial

Permite a regulação do valor de velocidade do fio durante a primeira fase de soldadura “enchimento de cratera”. Possibilita o aumento da energia fornecida à peça, na fase em que o material (ainda frio) requer mais calor, para que derreta de maneira uniforme.

Mínimo	Máximo	Predefinido
20 %	200 %	120 %

26 Crater filler

Permite a regulação do valor de velocidade do fio durante a fase de conclusão da soldadura. Possibilita a redução da energia fornecida à peça, na fase em que o material já se encontra muito quente, reduzindo, assim, o risco de deformações indesejáveis.

Mínimo	Máximo	Predefinido
20 %	200 %	80 %

27 Tempo de incremento inicial



Permite definir o tempo de incremento inicial. Permite automatizar a função “enchimento de cratera”.

Mínimo	Máximo	Predefinido
0.1 s	99.9 s	0/off

28 Tempo de enchimento de cratera

Permite definir o tempo de “enchimento de cratera”. Permite automatizar a função “enchimento de cratera”.

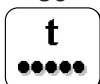
Mínimo	Máximo	Predefinido
0.1 s	99.9 s	0/off

30 Soldadura por pontos

Permite a activação do processo de “soldadura por pontos” e definir o tempo de soldadura.

Mínimo	Máximo	Predefinido
0.1 s	99.9 s	0/off

31 Ponto pausa

Permite activar o processo “ponto pausa” e estabelecer o tempo de pausa entre uma soldadura e a outra.

Mínimo	Máximo	Predefinido
0.1 s	99.9 s	0/off

32 Tensão secundária (Duplo nível MIG)

Permite a regulação da tensão do nível de pulsação secundário. Possibilita a obtenção de uma maior estabilidade do arco, durante as várias fases de pulsação.

Mínimo	Máximo	Predefinido
-5.0	+5.0	0/syn

33 Indutância secundária (Duplo nível MIG)

Permite a regulação da indutância do nível de pulsação secundário. Possibilita a obtenção de um arco mais ou menos rápido, para compensar os movimentos do soldador e a instabilidade natural da soldadura.

Indutância baixa = arco reactivo (mais salpicos).
Indutância alta = arco menos reactivo (menos salpicos).

Mínimo	Máximo	Predefinido
-30	+30	0/syn

34 Rampa de subida inicial

Permite definir uma transição gradual entre a velocidade inicial do fio e a velocidade de soldadura do fio.

Mínimo	Máximo	Predefinido
0 s	10 s	0/off

PT

35 Rampa de enchimento da cratera

Permite definir uma transição gradual entre a velocidade de soldadura do fio e a velocidade de enchimento da cratera.

Mínimo	Máximo	Predefinido
0 s	10 s	0/off

202 Indutância

Permite a regulação electrónica da indutância série do circuito de soldadura.

Possibilita a obtenção de um arco mais ou menos rápido, para compensar os movimentos do soldador e a instabilidade natural da soldadura.

Indutância baixa = arco reactivo (mais salpicos).

Indutância alta = arco menos reactivo (menos salpicos).

Mínimo	Máximo	Predefinido
-30	+30	0/syn

331 Tensão média compensada

Permite definir a tensão de soldadura.

398 Constante de referência da velocidade de deslocação

Constante de referência para todos os processos de soldadura

Valor da velocidade de deslocação do lança-chamas à qual o sistema faz referência para calcular os parâmetros de soldadura

399 Velocidade de corte

Permite definir a velocidade de soldadura.

Default cm/min: velocidade de referência para soldadura manual.

Syn: valor sinérgica.

Mínimo	Máximo	Predefinido
syn min	syn max	35 cm/min

500 Configuração da máquina

Permite seleccionar a interface gráfica pretendida.

Permite aceder aos níveis de definição superiores.

Consultar a secção "Personalização da interface (Set up 500)"

Valor	Interface do Utilizador
XE	Modo Básico
XA	Modo Avançado
XP	Modo Profissional

Valor	Nível seleccionado
USER	Utilizador
SERV	Service
vaBW	vaBW

551 Lock/unlock

Permite o bloqueio dos controlos do painel e a introdução de um código de protecção.

Consultar a secção "Lock/unlock (Set up 551)".

552 Tom avisador sonoro

Permite a regulação do tom avisador sonoro.

Mínimo	Máximo	Predefinido
0/off	10	10

601 Passo de regulação

Permite a regulação de um parâmetro, com um passo que pode ser personalizado pelo operador.

Funcionalidade controlada pelo botão para cima / para baixo da tocha.

Mínimo	Máximo	Predefinido
1	lmax	1

602 Parâmetro externo CH1, CH2, CH3, CH4

Permite a gestão do parâmetro externo 1, 2, 3, 4 (valor mínimo, valor máximo, valor predefinido, parâmetro seleccionado).

Consultar a secção "Gestão de controlos externos (Set up 602)".

606 Tocha U/D

Permite a gestão do parâmetro externo (U/D).

Valor	Predefinido	Função de retorno de chamada
0/off	-	off
1/I1	X	Corrente
	-	Recuperação de programas

612 Configuração do lança-chamas DgMig

Permite a gestão de canais do lança-chamas digital.

Valor	Predefinido	Função de retorno de chamada
0/off	-	off
1/I1	-	Corrente
2/ 	-	Recuperação de programas
3/CH3	-	CH3
4/CH4	-	CH4
5/STD	X	STD

653 Velocidade do fio

Permite a regulação da velocidade de avanço do fio (durante a fase de carregamento).

Mínimo	Máximo	Predefinido
0.5 m/min	22.0 m/min	3.0 m/min

705 Calibração da resistência do circuito

Permite calibrar o equipamento.

Consultar a secção "Calibração da resistência do circuito (set up 705)".

751 Leitura de corrente

Permite a apresentação do valor real da corrente de soldadura.

752 Leitura de tensão

Permite a apresentação do valor real da tensão de soldadura.

755 Leitura do fluxo de gás

Permite a apresentação do fluxo de gás real.

757 Leitura de velocidade do fio

Permite visualizar o valor do codificador do motor 1.

758 Velocidade de movimentação de robô

Permite a apresentação da velocidade de movimentação de um braço robotizado ou automatizado.

760 Leitura de corrente (motor 1)

Permite a apresentação do valor real da corrente (motor 1).

PT

768

Medição da aportação de calor HI

Permite ler o valor medido da aportação de calor durante a soldadura.



770

Valor da taxa de deposição

Permite ver o valor da taxa de deposição.



801

Limites de segurança

Permite a definição dos limites de aviso e dos limites de segurança.

Permite o controlo do processo de soldadura, através da definição de limites de aviso e limites de segurança, aplicáveis aos principais parâmetros mensuráveis.

Permite o controlo preciso das várias fases de soldadura.

Consultar a secção "Limites de segurança (Set up 801)".



5.2 Procedimentos específicos de utilização dos parâmetros

5.2.1 Personalização do visor de 7 segmentos

Permite ver constantemente o valor de um parâmetro no visor de 7 segmentos.

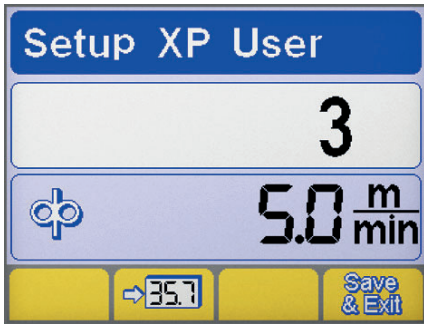

- ▶ Premir a tecla de codificação ("encoder") durante, pelo menos, 5 segundos, para aceder às definições.
- ▶ Rodar a tecla de codificação ("encoder").
- ▶ Carregar no botão, para armazenar o parâmetro seleccionado no visor de 7 segmentos .
- ▶ Carregar no botão, para salvar e sair do ecrã actual .

PT

5.2.2 Personalização da interface (Set up 500)

Permite que os parâmetros sejam personalizados no menu principal.

500

Configuração da máquina

Permite seleccionar a interface gráfica pretendida.



Valor	Interface do Utilizador
XE	Modo Básico
XA	Modo Avançado
XP	Modo Profissional

MODO XE

MIG/MAG

Parâmetros de soldadura

Funções

MODO XA

MIG/MAG

Parâmetros de soldadura

Funções

MODO XP

MIG/MAG	
Parâmetros de soldadura	
Funções	

5.2.3 Lock/unlock (Set up 551)

Permite o bloqueio dos controlos do painel e a introdução de um código de protecção.

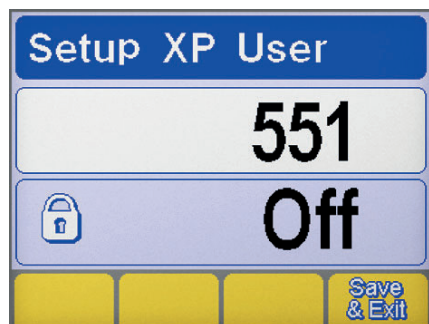
Seleção de parâmetro

- ▶ Premir a tecla de codificação (“encoder”) durante, pelo menos, 5 segundos, para aceder às definições.
- ▶ Seleccionar o parâmetro pretendido (551).
- ▶ Premir a tecla de codificação (“encoder”), para activar a regulação do parâmetro seleccionado.

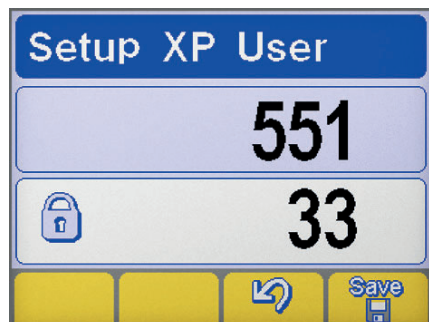
Definição da palavra passe

- ▶ Rodar a tecla de codificação (“encoder”), para definir um código numérico (palavra-passe).
- ▶ Premir o botão-encoder para confirmar a operação.
- ▶ Carregar no botão, para confirmar a operação .
- ▶ Para guardar a alteração, premir o botão: .

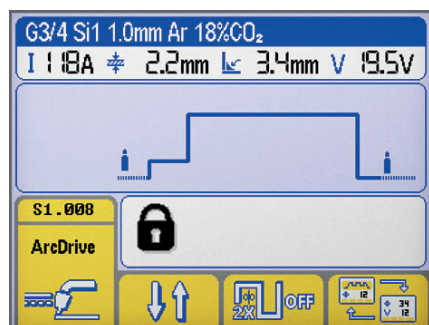
Funções do painel

- ▶ Rodar a tecla de codificação (“encoder”) e introduzir a palavra-passe correcta, para aceder temporariamente às funcionalidades do painel (5 minutos).
- ▶ Premir o botão-encoder para confirmar a operação.
- ▶ Aceder às definições (seguir as instruções dadas acima) e repor o parâmetro 551 em “off”, para desbloquear definitivamente o painel de controlo
- ▶ Premir o botão-encoder para confirmar a operação.
- ▶ Para guardar a alteração, premir o botão: .

5.2.4 Gestão de controlos externos (Set up 602)

Permite a gestão do parâmetro externo 2 (valor mínimo, valor máximo, valor predefinido, parâmetro seleccionado).

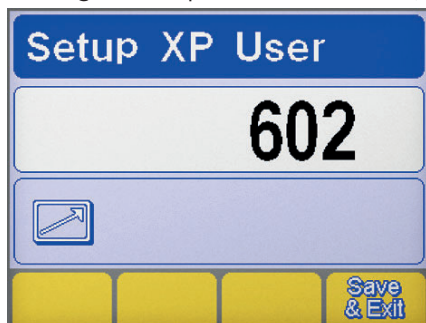
Seleção de parâmetro

- ▶ Premir a tecla de codificação (“encoder”) durante, pelo menos, 5 segundos, para aceder às definições.
- ▶ Seleccionar o parâmetro pretendido (602).
- ▶ Premir a tecla de codificação (“encoder”), para aceder ao ecrã “Gestão de controlos externos”.

PT

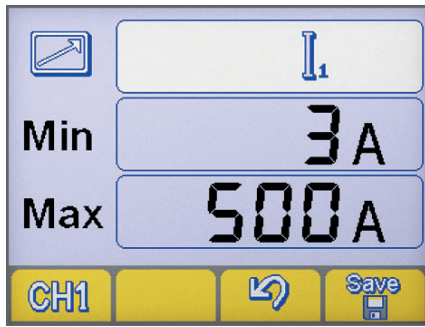

Gestão de controlos externos

- ▶ Carregar no botão, para seleccionar a saída de comando à distância RC pretendida (CH1, CH2, CH3, CH4).
- ▶ Premir a tecla de codificação ("encoder"), para seleccionar o parâmetro pretendido (Mín.-Máx-parâmetro).
- ▶ Rodar a tecla de codificação ("encoder"), para regular o parâmetro pretendido (Mín.-Máx-parâmetro).
- ▶ Para guardar a alteração, premir o botão:
- ▶ Carregar no botão, para confirmar a operação

5.2.5 Calibração da resistência do circuito (set up 705)

Permite calibrar o gerador para a resistência atual do circuito de soldadura.

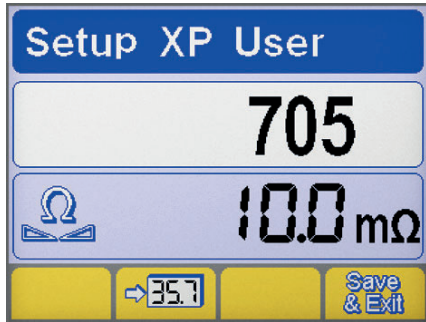

Seleção de parâmetro

- ▶ Premir a tecla de codificação ("encoder") durante, pelo menos, 5 segundos, para aceder às definições.
- ▶ Seleccionar o parâmetro pretendido (705).
- ▶ Premir a tecla de codificação ("encoder"), para activar a regulação do parâmetro seleccionado.
- ▶ Ligar o gerador ao circuito de soldadura (banca ou peça).
- ▶ Tirar a tampa para aplicar a ponta adaptadora do bico do lança-chamas exposta. (MIG/MAG)

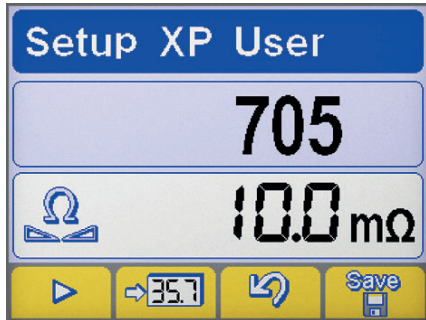

Calibração

- ▶ Colocar a extremidade do guia de fio em contacto eléctrico com a peça de trabalho. (MIG/MAG)
- ▶ Premir o botão para começar o procedimento.
- ▶ Manter o contacto durante, pelo menos, um segundo.
- ▶ O valor exibido no visor será atualizado no final da calibração.
- ▶ Carregar no botão, para confirmar a operação
- ▶ Carregar no botão, para confirmar a operação
- ▶ Para guardar a alteração e sair da configuração, premir o botão:

5.2.6 Limites de segurança (Set up 801)

Permite a definição dos limites de aviso e dos limites de segurança.

Permite o controlo do processo de soldadura, através da definição de limites de aviso e limites de segurança, aplicáveis aos principais parâmetros mensuráveis.

Permite o controlo preciso das várias fases de soldadura.

Consultar a secção "Limites de segurança (Set up 801)".



- | | |
|---|------------------------------------|
| Corrente de soldadura | Tensão de soldadura |
| Leitura do fluxo de gás | Velocidade de movimentação de robô |
| Leitura de corrente (motor 1) | Leitura de corrente (motor 2) |
| Medição do fluxo do líquido de refrigeração | Leitura de velocidade do fio |
| Leitura de temperatura do líquido de refrigeração | |

PT

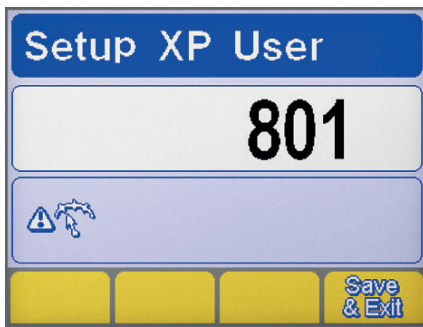

Seleção de parâmetro

- ▶ Premir a tecla de codificação (“encoder”) durante, pelo menos, 5 segundos, para aceder às definições.
- ▶ Seleccionar o parâmetro pretendido (801).
- ▶ Premir a tecla de codificação (“encoder”), para aceder ao ecrã “Limites de segurança”.

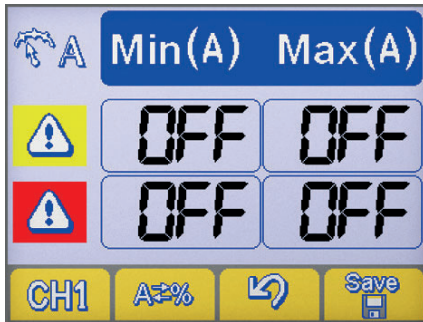

Seleção do parâmetro

- ▶ Carregar no botão para seleccionar o parâmetro pretendido **CH1**.
- ▶ Carregar no botão para seleccionar o método de definição dos limites de segurança **A=%**.

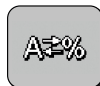

Configuração da máquina



Valor absoluto



Valor percentual

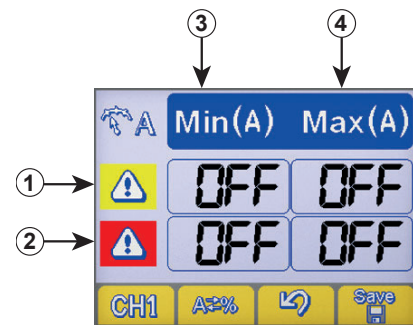

Definição dos limites de alerta

- ① Linha dos limites de aviso
- ② Linha dos limites de alarme
- ③ Coluna de níveis mínimos
- ④ Coluna de níveis máximos

- ▶ Premir a tecla de codificação (“encoder”), para seleccionar a caixa pretendida (a caixa seleccionada é apresentada com inversão de contraste).
- ▶ Rodar a tecla de codificação (“encoder”), para regular o nível do limite seleccionado.
- ▶ Para guardar a alteração, premir o botão: **Save**.



Ultrapassar um dos limites de aviso faz surgir um sinal visual no painel de controlo.



Ultrapassar um dos limites de alarme faz surgir um sinal visual no painel de controlo e provoca o bloqueio imediato das operações de soldadura.



É possível definir filtros de soldadura iniciais e finais, para evitar sinais de erro na ignição e extinção do arco (consultar a secção “Definições” - Parâmetros 802-803-804).

6. ACESSÓRIOS

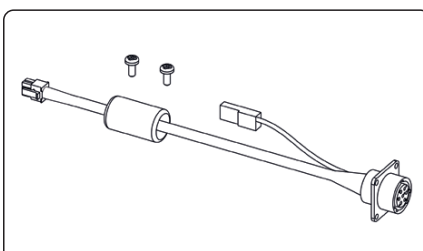

Kit RC (WF... Steeldrive)
73.11.015

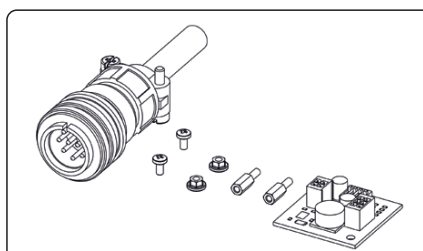

Kit Push-Pull
73.11.012

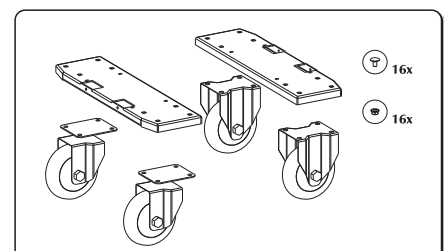

Feed unit big wheels - upgrade kit
73.10.073

PT

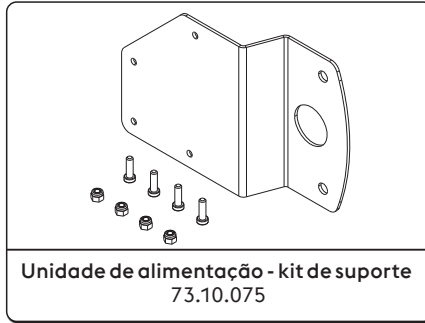
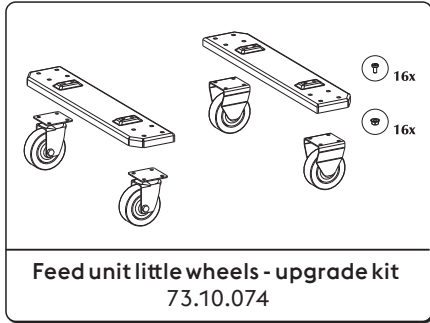

*Montado na fábrica
Consultar a secção "Instalação kit/acessórios".

7. MANUTENÇÃO



A instalação deve ser submetida a operações de manutenção de rotina, de acordo com as indicações do fabricante. Quando o equipamento está em funcionamento, todas as portas e tampas de acesso e de serviço deverão estar fechadas e trancadas. Os sistemas não devem ser submetidos a qualquer tipo de modificação. Evitar a acumulação de poeiras condutoras de electricidade perto das aletas de ventilação e sobre as mesmas.



As operações de manutenção deverão ser efectuadas exclusivamente por pessoal especializado. A reparação ou substituição de componentes do sistema que seja executada por pessoal não-autorizado implica a imediata anulação da garantia do produto. A eventual reparação ou substituição de componentes do sistema tem de ser executada exclusivamente por pessoal técnico qualificado.



Antes da qualquer operação de manutenção, desligar o equipamento da corrente eléctrica!

7.1 Efectuar periodicamente as seguintes operações



Limpar o interior do gerador com ar comprimido a baixa pressão e com escovas de cerdas suaves. Verificar as ligações eléctricas e todos os cabos de ligação.

7.2 Ansvar



Caso a referida manutenção não seja executada, todas as garantias serão anuladas, isentando o fabricante de toda e qualquer responsabilidade. O incumprimento destas instruções isentará o fabricante de toda e qualquer responsabilidade. Se tiver quaisquer dúvidas e/ou problemas, não hesite em contactar o centro de assistência técnica mais perto de si.

8. CÓDIGOS DE ALARME



ALARME

A intervenção de um alarme ou a superação de um limite de alerta crítico provoca um sinal visual no painel de comando e o bloqueio imediato das operações de soldadura.



ATENÇÃO

A ultrapassagem de um limite de alerta provoca uma assinalação visual no painel de comando, mas permite continuar as operações de soldadura.

Incluimos, a seguir, uma lista com todos os alarmes e limites de alerta inerentes ao sistema.

E01	Sobret temperatura		E02	Sobret temperatura	
E05	Sobrecorrente		E07	Erro no sistema de alimentação do motor do puxador de fio	
E08	Motor bloqueado		E10	Sobrecorrente do módulo de potência (Inverter)	
E12.1	Erro de comunicação WF1		E13	Erro de comunicação (FP)	

 E14.xx	Programa inválido o subcódigo de erro indica o número do trabalho eliminado.		 E15	Programa inválido	
 E16.1	Erro de comunicação RI 1000/2000/3000 (CAN bus)		 E16.2	Erro de comunicação RI 3000 (Modbus)	
 E16.3	Erro de comunicação RI 1000/2000		 E18.xx	Programa inválido o subcódigo de erro indica o número do trabalho eliminado.	
 E19	Erro de configuração do sistema		 E19.1	Erro de configuração do sistema	
 E19.11	Erro de configuração do sistema (WF)		 E20	Memória defeituosa	
 E21	Perda de dados		 E23	Programas de soldadura não presentes	
 E27	Memória defeituosa (RTC)		 E32	Perda de dados	
 E33.1	Erro de configuração do sistema (LCD 3.5")		 E33.3	Erro de comunicação (ACTIVATION KEY)	
 E33.4	Erro de comunicação (ACTIVATION KEY)		 E40	Falha na alimentação do equipamento	
 E43	Falta de líquido refrigerante		 E44	Falta de gás	
 E48	Falta de fio (Automatização e robótico)		 E50	Fio colado (Automatização e robótico)	
 E54	Nível de corrente ultrapassado (Limite inferior)		 E55	Nível de corrente ultrapassado (Limite superior)	
 E56	Nível de tensão ultrapassado (Limite inferior)		 E57	Nível de tensão ultrapassado (Limite superior)	
 E58	Nível de fluxo de gás ultrapassado (Limite inferior)		 E59	Nível de fluxo de gás ultrapassado (Limite superior)	
 E62	Nível de corrente ultrapassado (Limite inferior)		 E63	Nível de corrente ultrapassado (Limite superior)	
 E64	Nível de tensão ultrapassado (Limite inferior)		 E65	Nível de tensão ultrapassado (Limite superior)	
 E66	Nível de fluxo de gás ultrapassado (Limite inferior)		 E67	Nível de fluxo de gás ultrapassado (Limite superior)	

 E71	Sobretensão do líquido refrigerante		 E74	Nível de corrente do motor 1 ultrapassado	
 E76	Nível de fluxo do líquido refrigerante ultrapassado		 E77	Nível de temperatura do líquido refrigerante	
 E80	Falta de fio (wire end)		 E81	Sobrecorrente (bomba WU)	
 E82	Erro de comunicação (WU)		 E83	Bomba bloqueada	
 E99.2	Alarme de configuração do sistema (inverter)		 E99.3	Alarme de configuração do sistema (FP)	
 E99.4	Alarme de configuração do sistema (FP)		 E99.5	Alarme de configuração do sistema (FP)	
 E99.6	Alarme de configuração do sistema		 E99.11	Memória defeituosa	

9. RESOLUÇÃO DE PROBLEMAS

Mecanismo de avanço do fio bloqueado

Causa

- » Botão de accionamento da tocha danificado.
- » Rolos incorrectos ou gastos.
- » Mecanismo de avanço de fio danificado.
- » Bainha da tocha danificada.
- » Mecanismo de avanço de fio não alimentado.
- » Enrolamento irregular na bobina.
- » Bico da tocha fundido (fio colado)

Solução

- » Substituir o componente danificado.
- » Contactar o centro de assistência mais próximo para a reparação do sistema.
- » Substituir os rolos.
- » Substituir o componente danificado.
- » Contactar o centro de assistência mais próximo para a reparação do sistema.
- » Substituir o componente danificado.
- » Contactar o centro de assistência mais próximo para a reparação do sistema.
- » Verificar a ligação à fonte de alimentação.
- » Consultar a secção "Ligações".
- » Contactar o centro de assistência mais próximo para a reparação do sistema.
- » Restabelecer as condições normais de enrolamento da bobina ou substituí-la.
- » Substituir o componente danificado.

Avanço do fio irregular

Causa

- » Botão de accionamento da tocha danificado.
- » Rolos incorrectos ou gastos.

Solução

- » Substituir o componente danificado.
- » Contactar o centro de assistência mais próximo para a reparação do sistema.
- » Substituir os rolos.

» Mecanismo de avanço de fio danificado.

» Substituir o componente danificado.

» Contactar o centro de assistência mais próximo para a reparação do sistema.

» Bainha da tocha danificada.

» Substituir o componente danificado.

» Contactar o centro de assistência mais próximo para a reparação do sistema.

» Engrenagem do carretel ou dispositivos de bloqueio dos rolos mal regulados.

» Desapertar a engrenagem.

» Aumentar a pressão nos rolos.

Incrustações de escórias

Causa

» Remoção incompleta da escória.

» Eléctrodo com diâmetro excessivo.

» Preparação incorrecta dos bordos.

» Modo de execução da soldadura incorrecto.

Solução

» Limpar as peças devidamente, antes de executar a soldadura.

» Utilizar um eléctrodo com diâmetro inferior.

» Aumentar a abertura do chanfro.

» Reduzir a distância entre o eléctrodo e a peça.

» Avançar regularmente durante todas as fases da soldadura.

Poros

Causa

» Gás de protecção insuficiente.

Solução

» Regular correctamente o fluxo do gás.

» Verificar se o difusor e o bico de gás da tocha se encontram em boas condições.

Colagem

Causa

» Comprimento incorrecto do arco.

» Parâmetros de soldadura incorrectos.

» Modo de execução da soldadura incorrecto.

» Peças a soldar demasiado grandes.

» Dinâmica do arco incorrecta.

Solução

» Aumentar a distância entre o eléctrodo e a peça

» Aumentar a tensão de soldadura.

» Aumentar a corrente de soldadura.

» Aumentar a tensão de soldadura.

» Aumentar o ângulo de inclinação da tocha.

» Aumentar a corrente de soldadura.

» Aumentar a tensão de soldadura.

» Aumentar o valor indutivo do circuito equivalente.

Bordos queimados

Causa

» Parâmetros de soldadura incorrectos.

» Comprimento incorrecto do arco.

» Modo de execução da soldadura incorrecto.

» Gás de protecção insuficiente.

Solução

» Reduzir a tensão de soldadura.

» Reduzir a distância entre o eléctrodo e a peça.

» Reduzir a tensão de soldadura.

» Reduzir a velocidade de oscilação lateral no enchimento.

» Reduzir a velocidade de avanço em soldadura.

» Utilizar gases adequados aos materiais a soldar.

Oxidações

Causa

» Gás de protecção insuficiente.

Solução

» Regular correctamente o fluxo do gás.

» Verificar se o difusor e o bico de gás da tocha se encontram em boas condições.

Porosità

Causa

» Presença de gordura, tinta, ferrugem ou sujidade nas peças a soldar.

» Presença de gordura, tinta, ferrugem ou sujidade no material de adição.

Solução

» Limpar as peças devidamente, antes de executar a soldadura.

» Utilizar sempre produtos e materiais de qualidade.

» Manter sempre o material de adição em perfeitas condições.

- | | |
|---|--|
| <ul style="list-style-type: none"> » Presença de humidade no material de adição. | <ul style="list-style-type: none"> » Utilizar sempre produtos e materiais de qualidade. » Manter sempre o material de adição em perfeitas condições. |
| <ul style="list-style-type: none"> » Comprimento incorrecto do arco. | <ul style="list-style-type: none"> » Reduzir a distância entre o eléctrodo e a peça. » Reduzir a tensão de soldadura. |
| <ul style="list-style-type: none"> » Presença de humidade no gás de soldadura. | <ul style="list-style-type: none"> » Utilizar sempre produtos e materiais de qualidade. » Manter sempre o sistema de alimentação do gás em perfeitas condições. |
| <ul style="list-style-type: none"> » Gás de protecção insuficiente. | <ul style="list-style-type: none"> » Regular correctamente o fluxo do gás. » Verificar se o difusor e o bico de gás da tocha se encontram em boas condições. |
| <ul style="list-style-type: none"> » Solidificação demasiado rápida do banho de fusão. | <ul style="list-style-type: none"> » Reduzir a velocidade de avanço em soldadura. » Executar um pré-aquecimento das peças a soldar. » Aumentar a corrente de soldadura. |

Fissuras a quente

Causa

- » Parâmetros de soldadura incorrectos.
- » Presença de gordura, tinta, ferrugem ou sujidade nas peças a soldar.
- » Presença de gordura, tinta, ferrugem ou sujidade no material de adição.
- » Modo de execução da soldadura incorrecto.
- » Peças a soldar com características diferentes.

Solução

- » Reduzir a tensão de soldadura.
- » Limpar as peças devidamente, antes de executar a soldadura.
- » Utilizar sempre produtos e materiais de qualidade.
- » Manter sempre o material de adição em perfeitas condições.
- » Executar a sequência correcta de operações para o tipo de junta a soldar.
- » Executar um amanteigamento antes de executar a soldadura.

Fissuras a frio

Causa

- » Presença de humidade no material de adição.
- » Geometria particular da junta a soldar.

Solução

- » Utilizar sempre produtos e materiais de qualidade.
- » Manter sempre o material de adição em perfeitas condições.
- » Executar um pré-aquecimento das peças a soldar.
- » Executar um pós-aquecimento.
- » Executar a sequência correcta de operações para o tipo de junta a soldar.

PT

10. INSTRUÇÕES OPERACIONAIS

10.1 Soldadura com fio contínuo (MIG/MAG)

Introdução

Um sistema MIG é formado por uma fonte de alimentação em corrente contínua, um mecanismo de avanço do fio, uma bobina de fio, uma tocha e gás.

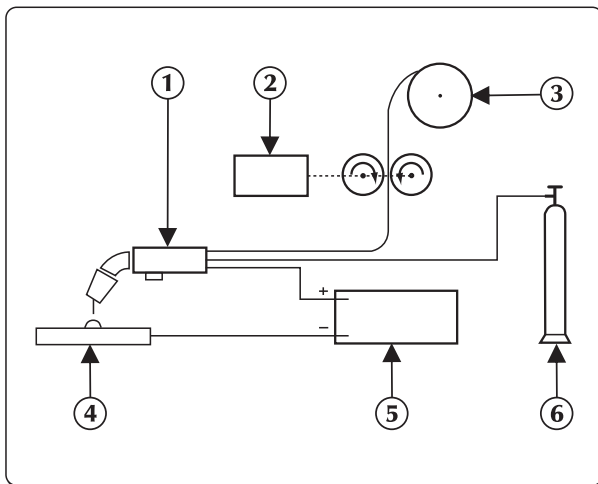

Equipamento de soldadura manual

A corrente é transferida para o arco eléctrico através do eléctrodo fusível (fio ligado ao pólo positivo); Neste procedimento, o metal fundido é transferido, através do arco eléctrico, para a peça a ser soldada.

A alimentação automática do eléctrodo de material de adição contínuo (fio) é necessária, para reintegrar o fio fundido durante a soldadura.

1. Tocha
2. Puxador de fio
3. Fio de soldadura
4. Peça a ser soldada
5. Gerador
6. Botija

Métodos de procedimento

Na soldadura MIG, há dois mecanismos principais de transferência de metal, que podem ser classificados consoante o modo como o metal é transferido do eléctrodo para a peça de trabalho.

Um primeiro método, denominado “TRANSFERÊNCIA POR CURTO-CIRCUITO (SHORT-ARC)”, produz um banho de fusão de pequenas dimensões e solidificação rápida, em que o metal é transferido do eléctrodo para a peça de trabalho durante um curto período, quando aquele está em contacto com o banho de fusão. Neste período, o eléctrodo toca directamente com o banho de fusão, produzindo um curto-circuito que faz fundir o fio, interrompendo-o. Em seguida, o arco eléctrico acende-se novamente e o ciclo repete-se.

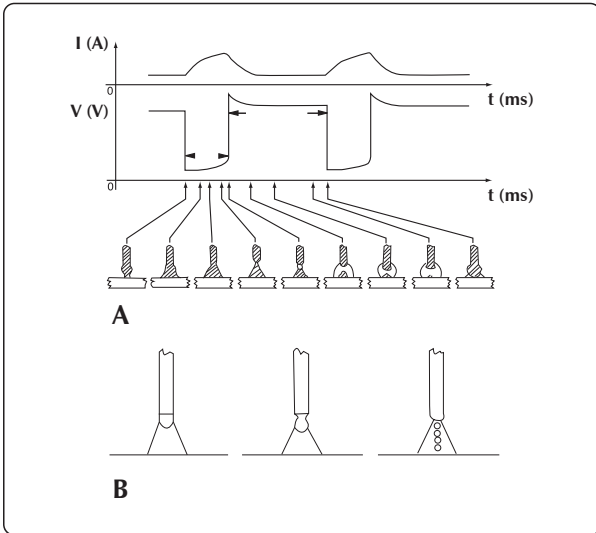

Ciclo “SHORT” e soldadura “SPRAY ARC”

Num outro método, denominado “TRANSFERÊNCIA SPRAY-ARC”, a transferência de metal ocorre em pequenas gotas que se formam e libertam da extremidade do fio, sendo transferidas para o banho de fusão através do arco.

Parâmetros de soldadura

A visibilidade do arco eléctrico reduz a necessidade de uma observância rígida das tabelas de regulação por parte do operador, que tem a possibilidade de controlar directamente o banho de fusão.

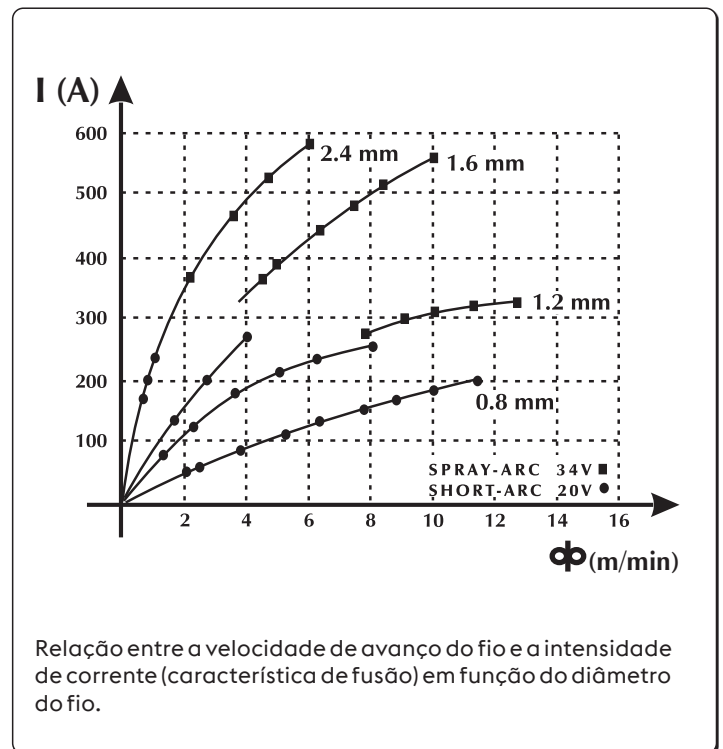
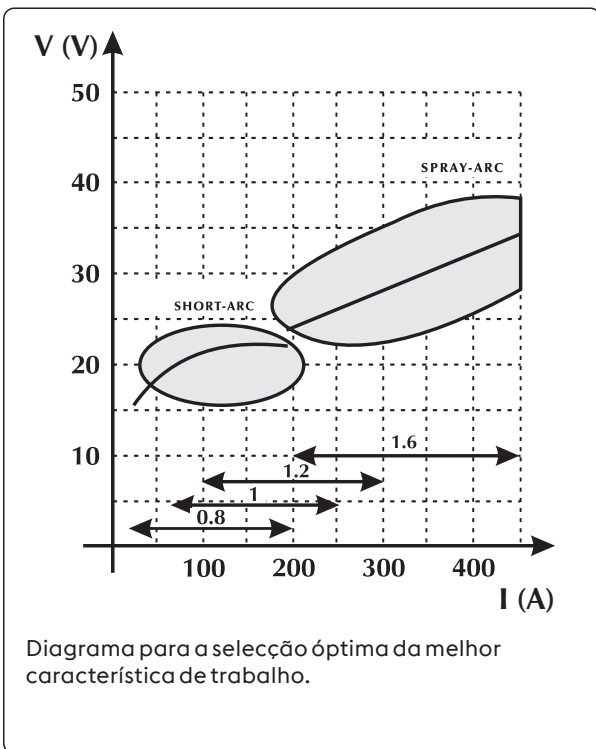

- A tensão influencia directamente o aspecto do cordão, mas as dimensões da superfície soldada podem ser modificadas em função das exigências, deslocando a tocha manualmente, para obter depósitos variáveis com tensão contínua.
- A velocidade de avanço do fio está relacionada com a corrente de soldadura.

As duas figuras seguintes mostram as relações entre os vários parâmetros de soldadura.

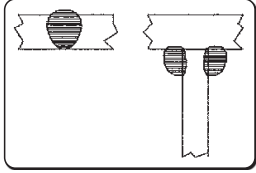
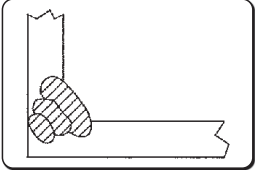
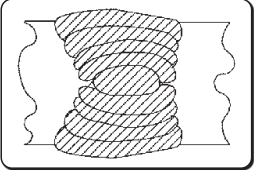

PT

Tabela de orientação para a escolha dos parâmetros de soldadura, relativamente às aplicações mais comuns e aos fios mais utilizados.

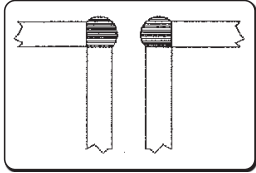
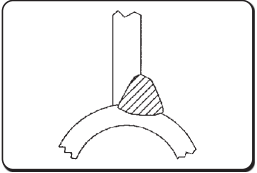
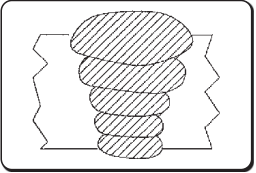
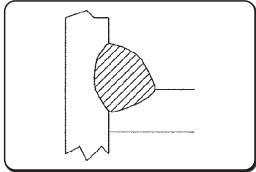
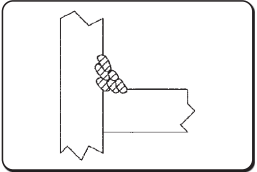
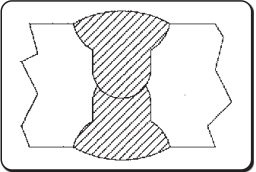
Tensão do arco	Ø 0,8 mm	Ø 1,0-1,2 mm	Ø 1,6 mm	Ø 2,4 mm
16V - 22V SHORT - ARC				
	60 - 160 A Baixa penetração para pequenas espessuras	100 - 175 A Bom controlo da penetração e da fusão	120 - 180 A Boa fusão horizontal e vertical	150 - 200 A Não utilizado
	<hr/>			
	24V - 28V SEMI SHORT-ARC (Zona de transição)			
150 - 250 A Soldadura automática em ângulo		200 - 300 A Soldadura automática de alta tensão	250 - 350 A Soldadura automática descendente	300 - 400 A Não utilizado
<hr/>				
30V - 45V "SPRAY - ARC"				
	150 - 250 A Baixa penetração com regulação a 200 A	200 - 350 A Soldadura automática com passagens múltiplas	300 - 500 A Boa penetração descendente	500 - 750 A Boa penetração com alto depósito em grandes espessuras

Unalloyed steel

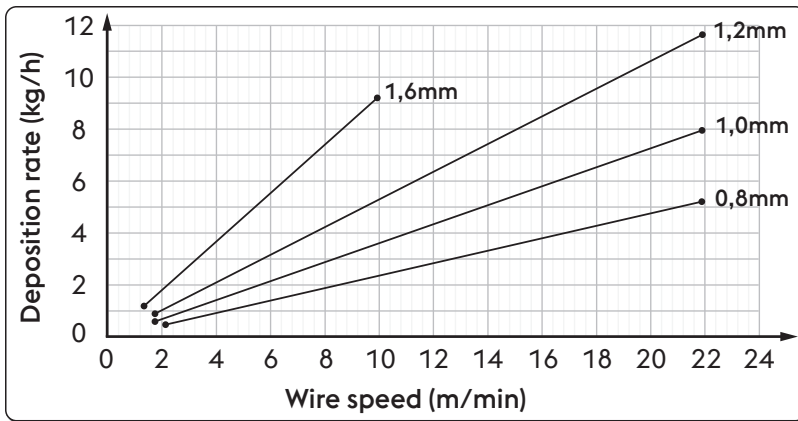

Ø	Wire speed	Deposition rate
0,8 mm	2,0 m/min	0,5 kg/h
	22,0 m/min	5,3 kg/h
1,0 mm	1,6 m/min	0,6 kg/h
	22,0 m/min	8,1 kg/h
1,2 mm	1,6 m/min	0,9 kg/h
	22,0 m/min	11,7 kg/h
1,6 mm	1,2 m/min	1,1 kg/h
	10,0 m/min	9,4 kg/h

High alloyed steel

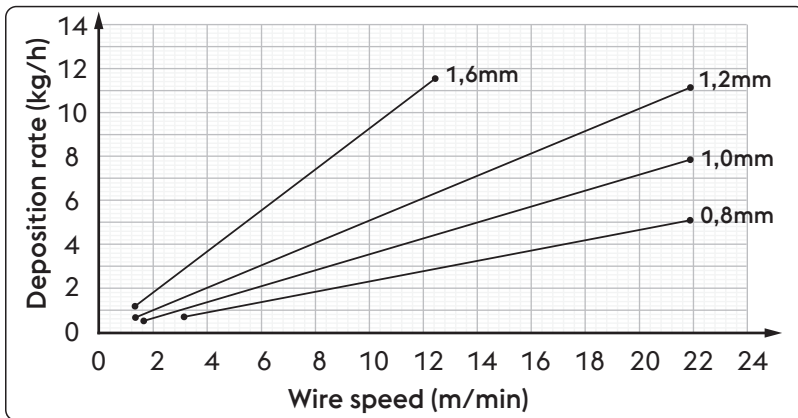

Ø	Wire speed	Deposition rate
0,8 mm	2,0 m/min	0,5 kg/h
	22,0 m/min	5,3 kg/h
1,0 mm	1,6 m/min	0,6 kg/h
	22,0 m/min	8,1 kg/h
1,2 mm	1,6 m/min	0,9 kg/h
	22,0 m/min	11,7 kg/h
1,6 mm	1,2 m/min	1,1 kg/h
	10,0 m/min	9,4 kg/h

Aluminum alloy

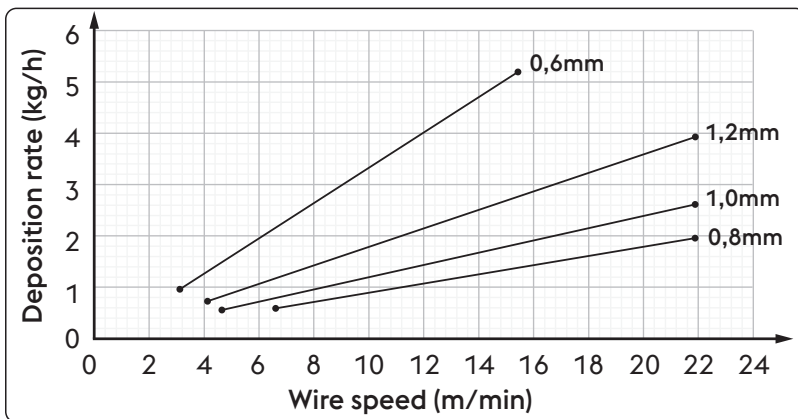

Ø	Wire speed	Deposition rate
0,8 mm	6,5 m/min	0,6 kg/h
	22,0 m/min	2,0 kg/h
1,0 mm	4,5 m/min	0,5 kg/h
	22,0 m/min	2,6 kg/h
1,2 mm	4,0 m/min	0,7 kg/h
	22,0 m/min	4,0 kg/h
1,6 mm	3,0 m/min	0,9 kg/h
	15,5 m/min	5,2 kg/h

PT

Gases utilizáveis

A soldadura MIG-MAG caracteriza-se principalmente pelo tipo de gás utilizado: inerte para a soldadura MIG (“Metal Inert Gas”), activo para a soldadura MAG (“Metal Active Gas”).

- Anidrido carbónico (CO₂)

Utilizando CO₂ como gás de protecção obtêm-se elevadas penetrações, elevada velocidade de avanço e boas propriedades mecânicas, juntamente com baixos custos operacionais. Não obstante, a utilização deste gás origina problemas consideráveis na composição química final das soldagens, dado existir uma elevada perda de elementos facilmente oxidáveis, simultaneamente com um enriquecimento de carbono do banho de fusão.

A soldadura com CO₂ puro implica também outro tipo de problemas, como excesso de salpicos e formação de porosidade de monóxido de carbono.

- Árgon

Este gás inerte é utilizado puro na soldadura de ligas leves e, com a adição de oxigénio e CO₂, numa percentagem de 2%, na soldadura de aços inoxidáveis de cromo-níquel; isto contribui para melhorar a estabilidade do arco e a formação do cordão de soldadura.

- Hélio

Este gás é utilizado como alternativa ao árgon, permitindo maiores penetrações (em grandes espessuras) e maiores velocidades de avanço.

- Mistura Árgon - Hélio

Proporciona um arco mais estável em relação ao hélio puro e uma maior penetração e velocidade em relação ao árgon.

- Mistura Árgon - CO₂ - e Árgon - CO₂ - Oxigénio

Estas misturas são utilizadas na soldadura de materiais ferrosos, sobretudo em condições de SHORT-ARC, pois melhoram o fornecimento de calor específico.

Isto não exclui o uso em SPRAY-ARC.

Normalmente a mistura contém uma percentagem de CO₂, compreendida entre 8%-20%, e de O₂, de aproximadamente 5%.

Consulte o manual de Instruções do sistema.

Unalloyed steel / High alloyed steel		Aluminum alloy	
Limites de corrente	Fluxo de gás	Limites de corrente	Fluxo de gás
3-50 A	10-12 l/min	3-50 A	10-12 l/min
30-100 A	10-14 l/min	30-100 A	10-15 l/min
75-150 A	12-16 l/min	75-150 A	12-18 l/min
150-250 A	14-18 l/min	150-250 A	14-22 l/min
250-400 A	16-20 l/min	250-400 A	16-25 l/min
400-500 A	18-22 l/min	400-500 A	18-30 l/min

11. CARACTERÍSTICAS TÉCNICAS

Características da unidade puxador de fio WF NX 430 SteelDrive		U.M.
Tipo de motorreductor	SL4R-4T	
Potência do mec. de avanço de fio	120	W
Nº rolos	4	
Diâmetro do fio/ Cilindro standard	1.0-1.2	mm
Diâmetro fios utilizáveis/Cilindros computadorizados	Velocidade de avanço do fio 0.8-1.6 fio de alumínio 1.2-2.4 fio fluxado	mm/Material
Botão de teste de gás	sim	
Botão de avanço de fio	sim	
Botão de recuo do fio	no	
Velocidade do fio	25 Ø 0.8 - 1.0	m/min
Sinergias	sim	
Dispositivos externos	sim (opcional)	
Tomada para tocha Push-Pull	sim (opcional)	
Diâmetro bobina	200/300	mm
Diâmetro rodas dianteiras	63/125 (optional)	mm
Diâmetro rodas traseiras	63/125 (optional)	mm
Características elétricas WF NX 430 SteelDrive		U.M.
Tensão de alimentação U1	48	Vdc
Bus de comunicação	DIGITALE	
Corrente máxima de entrada I1max	4.5	A
Factor de utilização WF NX 430 SteelDrive		U.M.
Factor de utilização (40°C)		
(X=50%)	500	A
(X=60%)	470	A
(X=100%)	420	A
Factor de utilização (25°C)		
(X=80%)	500	A
(X=100%)	470	A
Características físicas WF NX 430 SteelDrive		U.M.
Grau de protecção IP	IP23S	
Dimensões (lxwxh)	640x250x460	mm
Peso	19.0	Kg
Normas de construção	EN IEC 60974-5:2019 EN 60974-10/A1:2015	

12. PLACA DE DADOS

VOESTALPINE BÖHLER WELDING SELCO S.R.L. Via Palladio,19 - ONARA (PADOVA) - ITALY			
WF NX 430		N°	
EN 60974-5:2019 IEC 60974-10/A1:2015 Class A			
	X (40°C)	60%	100%
	I ₂	500A	400A
	U ₁ 48V	I _{1max} 4.5A	
IP 23 S		UK CA CE EAC	
MADE IN ITALY			

13. SIGNIFICADO DA PLACA DE DADOS

1		2	
3		4	
5			
	6	6A	6B
	7	7A	7B
8	9	10	
11		UK CA CE EAC	
MADE IN ITALY			

- 1 Marca de fabrico
- 2 Nome e morada do fabricante
- 3 Modelo de equipamento
- 4 N.º de série
- X XXXXXXXXXXXX Ano de fabrico
- 5 Referência às normas de fabrico
- 6 Símbolo do ciclo de intermitência
- 7 Símbolo de corrente nominal de soldadura
- 6A Valores do ciclo de intermitência
- 6B Valores do ciclo de intermitência
- 7A Valores da corrente nominal de soldadura
- 7B Valores da corrente nominal de soldadura
- 8 Símbolo para a alimentação
- 9 Tensão nominal de alimentação
- 10 Corrente nominal máxima de alimentação
- 11 Grau de proteção

- CE Declaração de conformidade UE
 EAC Declaração de conformidade EAC
 UKCA Declaração de conformidade UKCA

PT

EU-CONFORMITEITSVERKLARING

De bouwer

**voestalpine Böhler Welding Selco S.r.l. - Via Palladio, 19 - 35019 Onara di Tombolo (PD) - ITALY
Tel. +39 049 9413/111 - Fax +39 049 9413/311 - www.voestalpine.com/welding**

verklaart onder eigen verantwoordelijkheid dat het volgende product:

WF NX 430 STEELDRIVE

71.01.083

conform is met de normen EU:

2014/35/EU LOW VOLTAGE DIRECTIVE

2014/30/EU EMC DIRECTIVE

2011/65/EU RoHS DIRECTIVE

en dat de volgende geharmoniseerde normen zijn toegepast:

EN IEC 60974-5:2019

WIRE FEEDERS

EN 60974-10/A1:2015

ELECTROMAGNETIC COMPATIBILITY REQUIREMENTS

De documentatie waaruit blijkt dat aan de richtlijnen wordt voldaan, wordt ter inzage gehouden bij de bovengenoemde fabrikant.

Iedere ingreep of modificatie die niet vooraf door voestalpine Böhler Welding Selco S.r.l. is goedgekeurd maakt dit certificaat ongeldig.

Onara di Tombolo, 03/07/2023

voestalpine Böhler Welding Selco s.r.l.

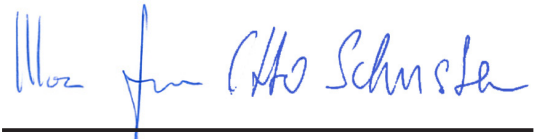

Mirco Frasson

Otto Schuster

Managing Directors

INHOUDSOPGAVE

1. WAARSCHUWING.....	233
1.1 Gebruiksomgeving.....	233
1.2 Bescherming voor de lasser en anderen.....	233
1.3 Bescherming tegen rook en gassen.....	234
1.4 Brand en explosie preventie.....	234
1.5 Voorzorgmaatregelen voor het gebruik van gasflessen.....	235
1.6 Beveiliging tegen elektrische schokken.....	235
1.7 Elektromagnetische velden en storingen.....	235
1.8 IP Beveiligingsgraad.....	236
1.9 Verwijdering.....	236
2. HET INSTALLEREN.....	236
2.1 Procedure voor het laden, vervoeren en lossen.....	237
2.2 Plaatsen van de installatie.....	237
2.3 Aansluiting.....	237
2.4 Installeren.....	237
3. PRESENTATIE VAN DE INSTALLATIE.....	239
3.1 Achter paneel.....	239
3.2 Paneel met contactpunten.....	239
3.3 Bedieningspaneel vooraan.....	240
4. GEBRUIK VAN APPARATUUR.....	241
4.1 Start scherm.....	241
4.2 Test scherm.....	241
4.3 Hoofd scherm.....	241
5. SETUP.....	245
5.1 Set up en instelling van de parameters.....	245
5.2 Specifieke gebruiksprocedures van de parameters.....	254
6. ACCESSOIRES.....	257
7. ONDERHOUD.....	258
7.1 Controleer de stroombron regelmatig als volgt.....	258
7.2 Odpovědnost.....	258
8. ALARM CODES.....	258
9. MEEST VOORKOMENDE VRAGEN EN OPLOSSINGEN.....	260
10. BEDIENINGSINSTRUCTIES.....	262
10.1 Lassen met constante draadtoevoer (MIG/MAG).....	262
11. TECHNISCHE KENMERKEN.....	267
12. GEGEVENSPLAAT.....	268
13. BETEKENIS GEGEVENSPLAATJE.....	268
14. SCHEMA.....	459
15. VERBINDINGEN.....	460
16. LIJST VAN RESERVE ONDERDELEN.....	461
17. HET INSTALLEREN KIT/ACCESSOIRES.....	464

SYMBOLLEN



Ernstig gevaar op zware verwondingen en waarbij onvoorzichtig gedrag zwaar letsel kan veroorzaken.



Belangrijke aanwijzingen die moeten opgevolgd worden om lichte persoonlijke letsels en beschadigingen aan voorwerpen te vermijden.



De opmerkingen die na dit symbool komen zijn van technische aard en ergemakkelijken de bewerkingen.

1. WAARSCHUWING



Voor het gebruik van de machine dient u zich ervan te overtuigen dat u de handleiding goed heeft gelezen en begrepen.

Breng geen veranderingen aan en voer geen onderhoudswerkzaamheden uit die niet in deze handleiding vermeld staan. De fabrikant kan niet verantwoordelijk worden gehouden voor lichamelijke schade of schade aan eigendommen die zijn veroorzaakt door verkeerd gebruik van de machine of het onjuist interpreteren van de handleiding.

Bewaar de gebruiksaanwijzing altijd op de plaats waar het apparaat wordt gebruikt. Naast de gebruiksaanwijzing dienen ook de algemene regels en plaatselijke voorschriften ter voorkoming van ongevallen en ter bescherming van het milieu in acht te worden genomen.



Ledereen die met de inbedrijfstelling, het gebruik, het onderhoud en de reparatie van het apparaat is belast moet:

- in het bezit zijn van een passende kwalificatie
- over de nodige lasvaardigheden beschikken
- deze gebruiksaanwijzing volledig doorlezen en strikt naleven

In geval van twijfel of problemen bij het gebruik, zelfs als het niet staat vermeldt, raadpleeg uw leverancier.

1.1 Gebruiksomgeving



Iedere machine mag alleen worden gebruikt voor de werkzaamheden waarvoor hij is ontworpen, op de manier zoals is voorschreven op de gegevensplaat en/of deze handleiding, in overeenstemming met de nationale en internationale veiligheidsvoorschriften. Oneigenlijk gebruik zal worden gezien als absoluut ongepast en gevaarlijk en in een dergelijk geval zal de fabrikant iedere verantwoordelijkheid afwijzen.



Deze apparatuur dient uitsluitend voor professionele doeleinde te worden gebruikt in een industriële omgeving. De fabrikant kan niet aansprakelijk worden gesteld voor schade veroorzaakt door gebruik van de apparatuur in een huishoudelijke omgeving.



De omgevingstemperatuur voor gebruik van de machine moet liggen tussen -10° C en +40° C (Tussen +14°F en +104°F).

Voor transport en opslag moet de temperatuur liggen tussen -25°C en +55°C (tussen -13°F en +131°F).

De machine moet worden gebruikt in een stofvrije omgeving zonder zuren, gas of andere corrosieve stoffen.

De vochtigheidsgraad van de werkomgeving van de machine mag niet hoger zijn dan 50% bij 40°C (104°F).

De vochtigheidsgraad van de werkomgeving van de machine mag niet hoger zijn dan 90% bij 20°C (68°F).

De machine kan worden gebruikt tot op een hoogte van 2000 meter boven de zeespiegel (6500 voet).



Gebruik de machine niet om pijpen te ontdoeien.

Gebruik de machine niet om batterijen en/of accu's op te laden.

Gebruik de machine niet om motoren mee te starten.

1.2 Bescherming voor de lasser en anderen



Bij het lasproces en ontstaan schadelijke stoffen zoals straling, lawaai, hitte en gasuitstoot. Plaats een vuurvast scherm om het lasgebied ter bescherming tegen straling, vonken en gloeiend afval. Adviseer iedereen in de nabijheid niet rechtstreeks in de lasboog of het gloeiende metaal te kijken en om een laskap te gebruiken.



Draag beschermende kleding om uw huid te beschermen tegen straling vonken en gloeiende metaalsplinters. De kleding moet het gehele lichaam bedekken:

- heel en van goede kwaliteit zijn
- vuurvast
- isolerend en droog
- goed passend en zonder manchetten en omslagen



Draag altijd goed, stevig waterdicht schoeisel.

Draag altijd goede hitte- en stroombestendige handschoenen.



Draag een laskap met zijflappen en met een geschikte lasruit (minimale sterkte nr. 10 of hoger) voor de ogen.



Draag altijd een veiligheidsbril met zijbescherming vooral tijdens het handmatig of mechanisch verwijderen van las afval.



Draag geen contactlenzen!



Gebruik gehoorbescherming als tijdens het lassen het geluidsniveau te hoog wordt. Als het geluidsniveau de wettelijk vastgestelde waarde overschrijdt moet de werkplek worden afgeschermd en moet iedereen die in de nabijheid komt gehoorbescherming dragen.



Laat de zijpanelen tijdens het lassen altijd gesloten. De installatie mag op geen enkele manier worden gewijzigd. Zorg ervoor dat uw handen, haar, kleding, gereedschap niet in aanraking kunnen komen met bewegende onderdelen zoals: ventilatoren, tandwielen, rollen en assen, draadspoelen. Raak tandwielen niet aan wanneer de draadtoevoeringeschakeld is. Het buitenwerken stellen van het beveiligingsmechanisme op de draadaanvoer unit is buitengewoon gevaarlijk en ontheft de fabrikant van alle verantwoordelijkheid voor letsel en schade aan personen en hun eigendommen.



Houdt tijdens het tijdens het laden en toevoeren van de draad uw hoofd weg van de MIG/MAG toorts. De uitgaande draad kan ernstig letsel veroorzaken aan handen, gezicht en ogen.



Raak zojuist gelaste voorwerpen niet aan, de grote hitte kan brandwonden veroorzaken. Volg alle veiligheidsvoorschriften op, ook tijdens bewerkingen na het lassen. Er kunnen tijdens het afkoelen van het werkstuk nog slakken loslaten.



Controleer vooraf of de toorts koud is voor u begint met lassen of met onderhoud begint.



Overtuig u ervan dat de koelunit is uitgeschakeld voordat u de leidingen van de koelvloeistof losmaakt. De hete vloeistof uit de leidingen kan ernstige brandwonden veroorzaken.



Houd een verbanddoos binnen handbereik. Onderschat brandwonden of andere verwondingen nooit.



Overtuigt u er voor dat u vertrekt van dat de werkplek goed is opgeruimd, zo voorkomt u ongevallen.

1.3 Bescherming tegen rook en gassen



Rook, gassen en stoffen die tijdens het lassen vrijkomen, kunnen gevaarlijk zijn voor de gezondheid. Onder bepaalde omstandigheden kan de lasrook kanker veroorzaken en bij zwangerschap de foetus schaden.

- Houdt u hoofd ver van de lasrook en gassen.
- Zorg voor goede ventilatie, natuurlijke of mechanische, op de werkplek.
- Gebruik bij slechte ventilatie maskers of verse lucht helmen.
- Bij het lassen in extreem kleine ruimten verdient het aanbeveling de lasser door een collega buiten de ruimte scherp in de gaten te laten houden.
- Gebruik geen zuurstof om te ventileren.
- Controleer of de afzuiging goed werkt door regelmatig na te gaan of schadelijke gassen in de luchtmonsters onder de norm blijven.
- De hoeveelheid en de mate van gevaar van de rook hangt af van het materiaal dat gelast wordt, het lasmateriaal en het schoonmaakmiddel dat is gebruikt om het werkstuk schoon en vetvrij te maken. Volg de aanwijzingen van de fabrikant en de bijgeleverde technische gegevens.
- Las niet direct naast plaatsen waar ontvet of geverfd wordt.
- Plaats gasflessen buiten of in goed geventileerde ruimten.

1.4 Brand en explosie preventie



Het las proces kan brand en/of explosies veroorzaken.

- Verwijder alle brandbare en lichtontvlambare producten van de werkplek en omgeving.
- Brandbare materialen moeten minstens op 11 meter (35 voet) van de lasplaats worden opgeslagen of ze moeten goed afgeschermd zijn.
- Vonken en gloeiende deeltjes kunnen makkelijk ver weg springen, zelfs door kleine openingen. Geef veel aandacht aan de veiligheid van mens en werkplaats.
- Las nooit boven of bij containers die onder druk staan.
- Las nooit in gesloten containers of buizen. Resten van gas, brandstof, olie of soortgelijke stoffen kunnen explosies veroorzaken.
- Las niet op plaatsen waar explosieve stoffen, gassen of dampen zijn.
- Controleer na het lassen of de stroomtoevoer niet per ongeluk contact maakt met de aardkabel.
- Installeer brandblusapparatuur in de omgeving van de werkplek.

1.5 Voorzorgmaatregelen voor het gebruik van gasflessen



Gasflessen zijn onder druk gevuld en kunnen exploderen als de veiligheidsvoorschriften niet in worden nageleefd bij vervoer, opslag en gebruik.

- De flessen moeten rechtop verankerd staan aan een muur of een andere stevige constructie zodat ze niet per ongeluk kunnen omvallen of tegen iets aanstoten.
- Draai de beschermdop van het ventiel goed vast tijdens transport, bij het aansluiten en bij het lassen.
- Stel de flessen niet bloot aan direct zonlicht of grote temperatuurschommelingen. Stel de flessen niet bloot aan extreme koude of hoge temperaturen.
- Laat de gasflessen niet in aanraking komen met open vuur, elektrische stroom, lastoortsen of elektrische klemmen of met wegspringende vonken en splinters.
- Houdt de gasflessen altijd uit de buurt van las- en stroomcircuits.
- Draai uw gezicht af wanneer u het ventiel van de gasfles open draait.
- Draai het ventiel van de gasfles na het werk altijd dicht.
- Las nooit aan gasflessen die onder druk staan.
- Een persluchtflus onder druk mag nooit direct gekoppeld worden aan het reduceerventiel van de lasmachine. De druk zou hoger kunnen zijn dan het vermogen van het reduceerventiel waardoor hij zou kunnen exploderen.

1.6 Beveiliging tegen elektrische schokken



Elektrische schokken kunnen dodelijk zijn.

- Vermijd het aanraken van spanningvoerende delen binnen of buiten de lasapparatuur terwijl de apparatuur zelf onder spanning staat (toortsen, klemmen, massakabels, elektroden, draden, haspels en spoelen zijn elektrisch verbonden met het lascircuit).
- Zorg voor elektrische isolatie van het systeem en de bediener door droge vloeren en ondergronden te gebruiken die voldoende geïsoleerd zijn van het massa- en aardingspotentialiaal.
- Overtuigt u ervan dat de machine goed is aangesloten aan de contactdoos en dat de krachtbron voorzien is van een aardkabel.
- Raak nooit twee toortsen of elektrodehouders tegelijk aan.
- Stop direct met lassen als u een elektrische schok voelt.

1.7 Elektromagnetische velden en stringen



De stroom die intern en extern door de kabels van de machine gaat veroorzaakt een elektromagnetisch veld rondom de kabels en de machine.

- Deze elektromagnetische velden zouden een negatief effect kunnen hebben op mensen die er langere tijd aan bloot gesteld zijn. (de juiste effecten zijn nog onbekend).
- Elektromagnetische velden kunnen stringen veroorzaken bij hulpmiddelen zoals pacemakers en gehoorapparaten.



Personen die een pacemaker hebben moeten eerst hun arts raadplegen voor zij las- of plasma snij werkzaamheden gaan uitoefenen.

1.7.1 EMC classificatie in overeenstemming met: EN 60974-10/A1:2015.

Klasse
B

Klasse B apparatuur voldoet aan de elektromagnetische eisen van aansluiting zowel wat betreft de industriële omgeving als de woonomgeving, inclusief de woonomgeving waar de stroomvoorziening wordt betrokken van het netwerk en dus met een lage spanning.

Klasse
A

Klasse A apparatuur is niet bedoeld om te gebruiken in de woonomgeving waar de stroom geleverd wordt via het normale netwerk met lage spanning. In een dergelijke omgeving kunnen zich potentiële moeilijkheden voordoen bij het veilig stellen van de elektromagnetische aansluiting van klasse A apparatuur veroorzaakt door geleiding of storing door straling.

Zie voor meer informatie: GEGEVENSPLAAT of TECHNISCHE KENMERKEN.

1.7.2 Installatie, gebruik en evaluatie van de werkplek

Deze apparatuur is gebouwd volgens de aanwijzingen in de geharmoniseerde norm EN 60974-10/A1:2015 en wordt gerekend tot de Klasse A. Deze apparatuur dient uitsluitend voor professionele doeleinde te worden gebruikt in een industriële omgeving. De fabrikant kan niet aansprakelijk worden gesteld voor schade veroorzaakt door gebruik van de apparatuur in een huishoudelijke omgeving.



De gebruiker moet een vakkundig iemand zijn die zich verantwoordelijk voelt voor de apparatuur en er gebruik van maakt volgens de richtlijnen van de fabrikant. Wanneer zich elektromagnetische storingen voordoen moet de lasser de problemen oplossen zonodig met de technische assistentie van de fabrikant.



In ieder geval dient de elektromagnetische storing zodanig gereduceerd te worden dat het geen hinder meer vormt.



Voor de installatie dient de gebruiker de risico's te evalueren die elektromagnetische storingen zouden kunnen opleveren voor de directe omgeving, hierbij in het bijzonder lettend op de gezondheidsrisico's voor personen op en in de omgeving van de werkplek, bij voorbeeld mensen die een pacemaker of een gehoorapparaat hebben.

1.7.3 Voorzorgsmaatregelen voor kabels

Om de effecten van de elektromagnetische velden zo klein mogelijk te houden dient u de hieronder staande richtlijnen te volgen:

- Houdt de laskabel en de aardkabel zoveel mogelijk bij elkaar opgerold.
- Vermijdt dat de kabels rond uw lichaam draaien.
- Vermijdt dat u tussen de aard- en de laskabel in staat, (houdt beide aan één kant).
- De kabels moeten zo kort mogelijk gehouden worden, bij elkaar gehouden op of zo dicht mogelijk bij de grond.
- Plaats de apparatuur op enige afstand van de werkplek.
- Houdt de kabels ver verwijderd van andere kabels.

1.7.4 Geaarde verbinding van de installatie

Het wordt aanbevolen alle verbindingen van alle metalen onderdelen in de las machine en in de omgeving ervan te aarden. Deze verbindingen dienen te zijn gemaakt volgens de plaatselijk geldende veiligheids regels.

1.7.5 Het werkstuk aarden

Wanneer het werkstuk niet geaard is vanwege elektrische veiligheid, de afmeting of de plaats waar het staat kan het aarden van het werkstuk de straling verminderen. Het is belangrijk er aan te denken dat het aarden van het werkstuk zowel het gevaar voor de lasser op ongelukken als schade aan andere apparatuur niet mag vergroten. Het aarden moet volgens de plaatselijke veiligheidsvoorschriften gebeuren.

1.7.6 Afscherming

Door het selectief afschermen van andere kabels en apparatuur in de directe omgeving kunnen de storingsproblemen afnemen.

Bij speciale toepassingen kan het worden overwogen de gehele lasplaats af te schermen.

1.8 IP Beveiligingsgraad



IP23S

- De kast voorkomt dat gevaarlijke onderdelen met de vingers of voorwerpen met een diameter tot 12.5mm kunnen worden aangeraakt.
- De kast beschermt tegen inregenen tot een hoek van 60° in verticale stand.
- De kast beschermt tegen de gevolgen van binnen druppelend water als de machine niet aanstaat.

1.9 Verwijdering



Verwijder elektrische apparatuur niet bij het normale afval!

In overeenstemming met de Europese Richtlijn 2012/19/EU betreffende afgedankte elektrische en elektronische apparatuur en de uitvoering daarvan in overeenstemming met de nationale wetgevingen, moet elektrische apparatuur die het einde van haar levenscyclus heeft bereikt, gescheiden worden ingezameld en naar een centrum voor nuttige toepassing en verwijdering worden gebracht. De eigenaar van de apparatuur dient bij de plaatselijke autoriteiten te informeren naar de erkende inzamelpunten. Door toepassing van de Europese richtlijn kunnen het milieu en de menselijke gezondheid worden verbeterd.

» Raadpleeg de website voor meer informatie.

2. HET INSTALLEREN



Het installeren dient te worden gedaan door vakkundig personeel met instemming van de fabrikant.



Overtuigt u ervan dat de stroom is uitgeschakeld voordat u gaat installeren.

2.1 Procedure voor het laden, vervoeren en lossen

- De machine is uitgerust met een handgreep voor transport.
- De machine is niet uitgerust met speciale hulpstukken voor bij het tillen.
- Gebruik een vorkheftruck maar let op dat de machine niet kantelt.



Onderschat het gewicht van de apparatuur niet, zie de technische specificatie.
Beweeg of hang het apparaat nooit boven personen of voorwerpen.
Laat het apparaat niet vallen of botsen.

2.2 Plaatsen van de installatie



Houdt u aan onderstaande regels:

- Zorg ervoor dat de installatie en de aansluitingen goed toegankelijk zijn.
- Plaats het apparaat niet in een te kleine ruimte.
- Plaats het apparaat niet op een schuin aflopende ondergrond van meer dan 10° waterpas.
- Plaats het apparaat in een droge, schone en goed geventileerde ruimte.
- Bescherm het apparaat tegen hevige regen en tegen de zon.

2.3 Aansluiting





De draagbare apparatuur van wordt uitsluitend gevoed met lage spanning.

2.4 Installeren

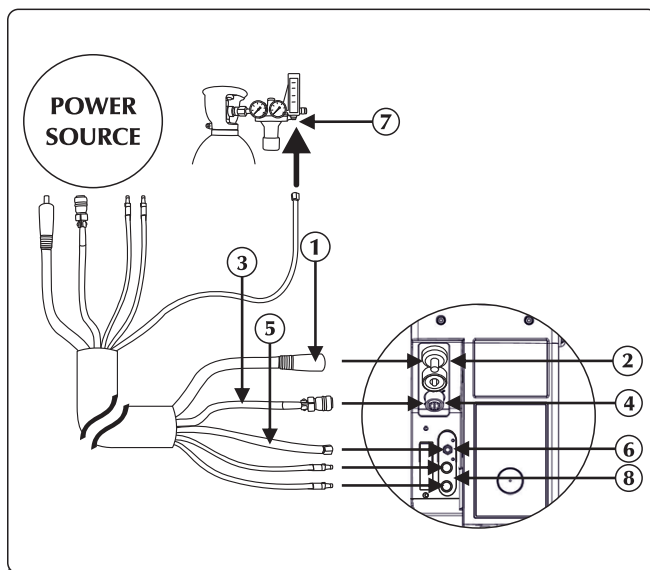
2.4.1 Verbinding voor MIG/MAG lassen



- ① Stroomkabel
- ② Positief contactpunt (+)
- ③ Signaalkabel
- ④ Ingang signaalkabel
- ⑤ Gasbuis
- ⑥ Gasaansluitkoppeling
- ⑦ Aansluiting gastoevoer
- ⑧ Koelvloeistof aansluiting

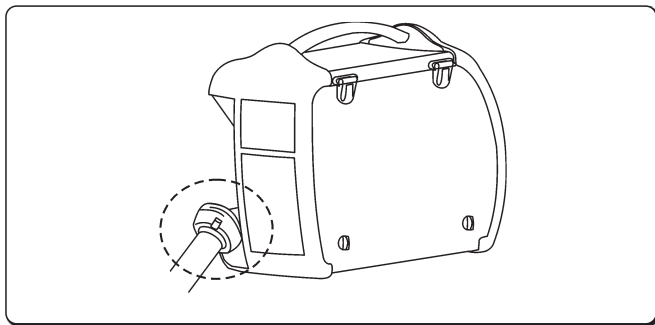

- ▶ Verbindt de stroomkabel met het juiste contactpunt. Plaats de stekker en draai met de klok mee tot hij stevig vast zit.
- ▶ Verbindt de signaalkabel met de juiste aansluitklem. Plaats de aansluitklem en draai de ringmoer met de klok mee aan tot de delen goed vast zitten.
- ▶ Verbindt de gasslang met het reduceerventiel van de gasfles of aan het gastoevoer koppelstuk. Stel de gasstroom in van 10 tot 30 l/min.
- ▶ Verbindt de slang voor de koelvloeistof (kleur blauw) van het tussenpakket met de snelkoppeling (kleur blauw - symbool ) van de koelunit.
- ▶ Verbindt de slang voor de koelvloeistof (kleur rood) van het tussenpakket met de snelkoppeling (kleur rood - symbool ) van de koelunit.
- ▶ Voor de controle van externe apparatuur (zoals RC, RI enz...) verbindt u de Can Bus signaal kabel aan de juiste kabelklem.

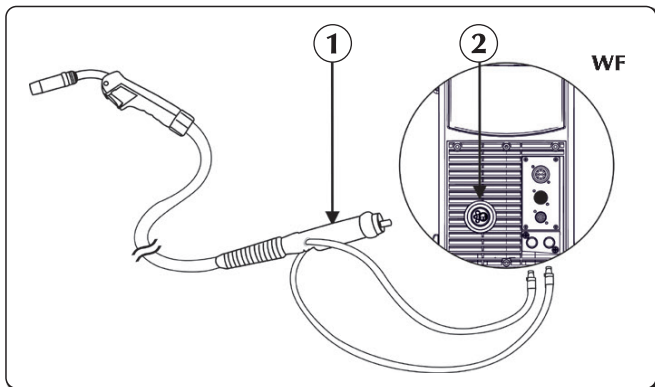

Raadpleeg het gedeelte "Het installeren accessoires".



- ① Toorts aansluiting
- ② Verbinding

- ▶ Verbindt de slang voor koelvloeistof (kleur rood) van de toorts met de snelkoppeling (kleur rood - symbool ) van de koelunit.
- ▶ Verbindt de slang voor koelvloeistof (kleur blauw) van de toorts met de snelkoppeling (kleur blauw - symbool ) van de koelunit.
- ▶ Sluit de MIG/MAG toorts aan de centrale adapter aan en overtuig u ervan dat de bevestigingsring goed is vastgedraaid.

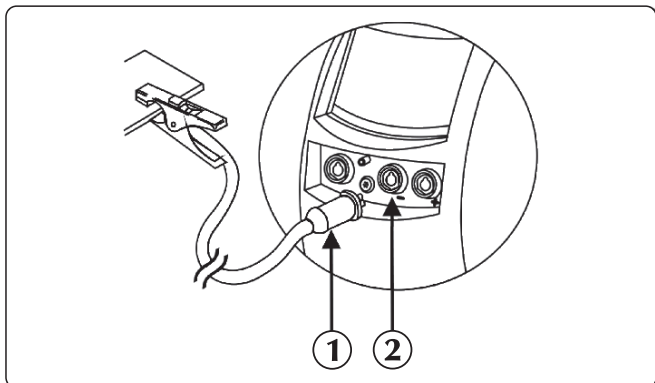

- ① Connector voor aardingsklem
- ② Negatief contactpunt (-)

- ▶ Verbind de aardklem aan de negatieve snelkoppeling (-) van de stroombron. Plaats de stekker en draai met de klok mee tot hij stevig vast zit.

Motorruimte

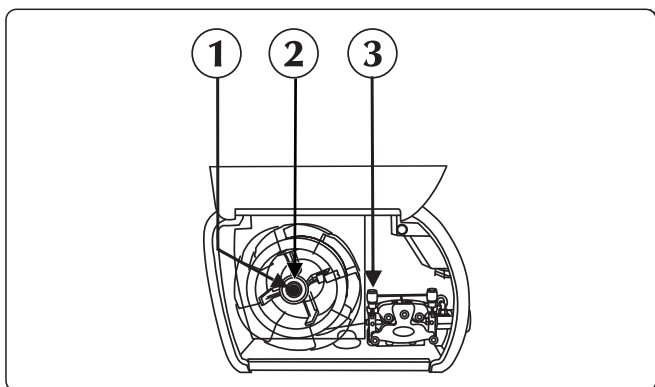

- ① Ring
- ② Plaats de schroef
- ③ Hendel van de rol van draadtoevoer

- ▶ Open het rechter zijpaneel.
- ▶ Controleer of de groef van de rol gelijk is aan de diameter van de draad waarmee u wilt werken.

- ▶ Draai de ring van de spoelhaspel los en plaats de spoel.
- ▶ Breng ook de pen van de haspel op z'n plaats, plaats de spoel, breng de ring weer in en plaats de schroef.
- ▶ Maak de hendel van de rol van draadtoevoer los, steek het uiteinde van draad in de draadgeleider en laat hem over de rol lopen, in de toorts hulpstuk. Vergrendel de draadtoevoer in de juiste positie en controleer of de draad in de groef van de rol zit.
- ▶ Om de draad in de toorts te brengen drukt u op de knop van de draadtoevoer.
- ▶ Stel de gasstroom in van 10 tot 30 l/min.

3. PRESENTATIE VAN DE INSTALLATIE

3.1 Achter paneel

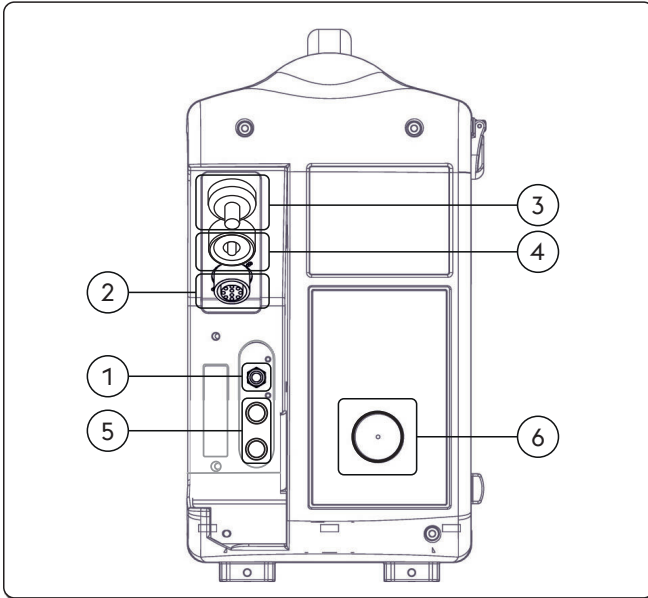

- ① Gas aansluiting
- ② Ingang signaalkabel (CAN-BUS) (kabelbundel)
- ③ Ingang vermogenskabel (kabelbundel)
- ④ Positief contactpunt (+)
- ⑤ Koelvloeistof inlet /outlet
- ⑥ Draadingang



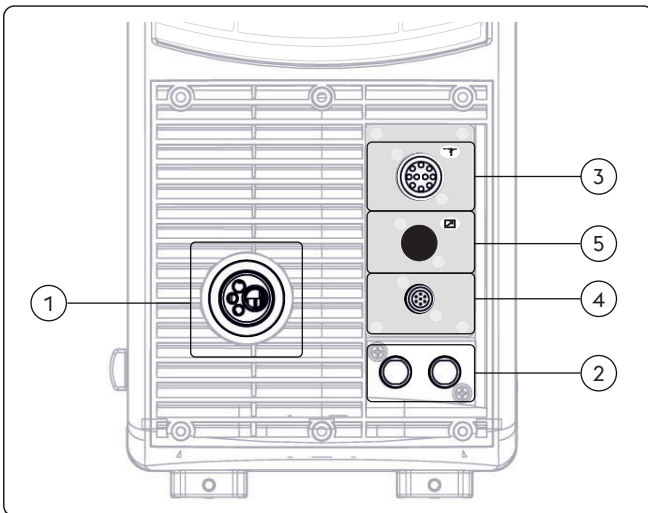



3.2 Paneel met contactpunten

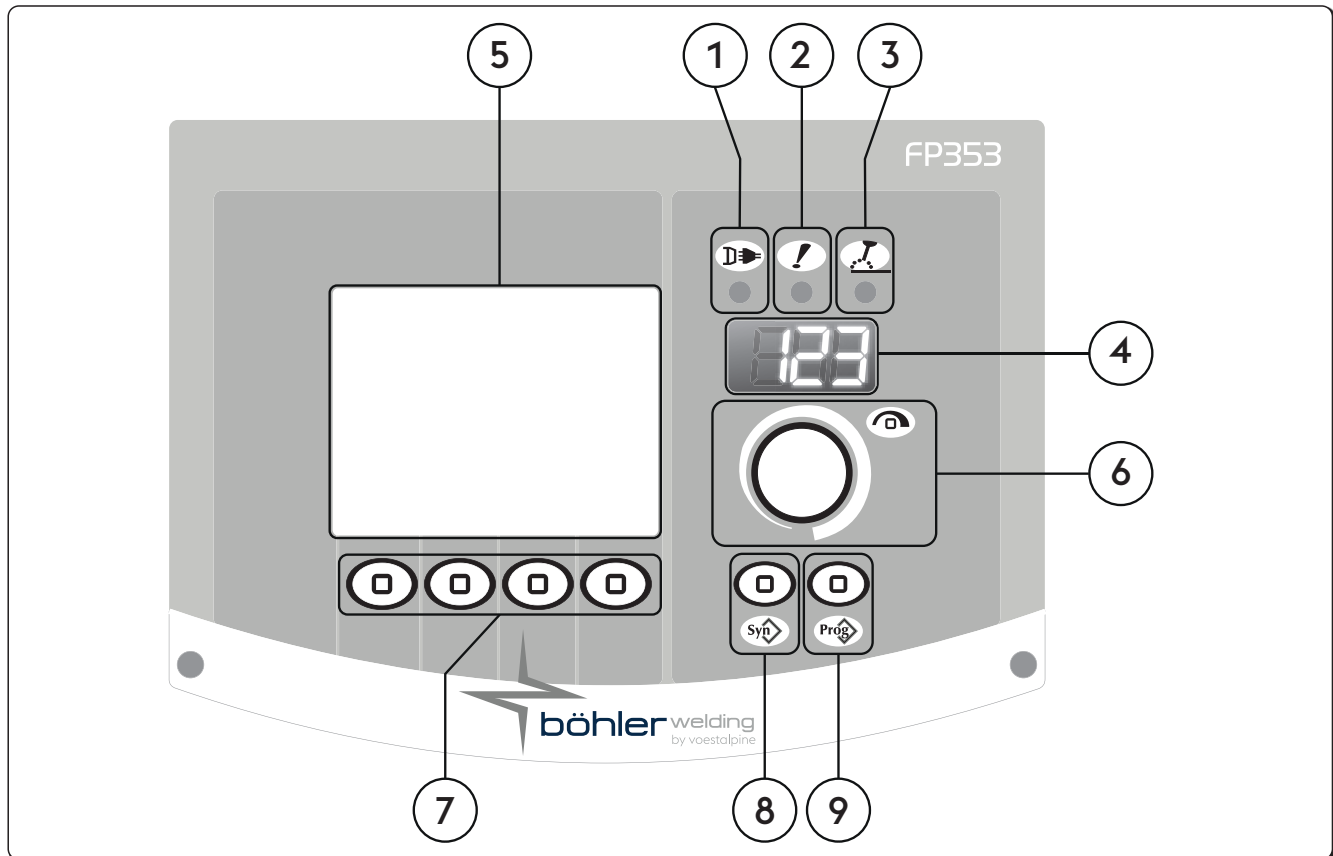

- ① Toortsaansluiting
Voor het aansluiten van de MIG/MAG toorts.
- ② Koelvloeistof aansluiting
- ③ Ingang signaalkabel (Push-Pull)
- ④ Ingang signaalkabel (toorts)
Toortsaansluiting
- ⑤ Signaal kabel (RC) invoer

3.3 Bedieningspaneel vooraan



- 1**  **Voedingsled**
Geeft aan dat de stroom is ingeschakeld en de machine aan staat.
- 2**  **Algemeen alarm-led**
Geeft aan dat het beveiligingssysteem een mogelijke storing constateert zoals bij voorbeeld bij een te hoge temperatuur.
- 3**  **Actief vermogen-led**
Geeft aan dat de boogspanning is geactiveer.
- 4**  **7-segmenten display**
Zorgt ervoor dat u de waarden van de parameters kunt aflezen tijdens het opstarten van de machine, de instellingen, de stroomtoevoer en de voltage tijdens het lassen, en de alarm codes.
- 5**  **LCD display**
Zorgt ervoor dat u de waarden van de parameters kunt aflezen tijdens het opstarten van de machine, de instellingen, de stroomtoevoer en de voltage tijdens het lassen, en de alarm codes.
Maakt het mogelijk dat alle handelingen direct getoond worden.
- 6**  **Belangrijkste instellingsknop**
Staat het opstarten toe. De keuze en de instelling van de las parameters.
- 7**  **Functietoetsen**
Hiermee kunnen de verschillende functies van de installatie geïnstalleerd worden:
- Las-proces
- Las methodes
- Pulserende stroom
- Grafische modus

8



Las programma's knop

Hiermee kan een vooraf ingesteld lasprogramma geselecteerd worden via onderstaande informatie:

- Soort draad
- type gas
- Draad diameter

9



Toets job

4. GEBRUIK VAN APPARATUUR

4.1 Start scherm

Wanneer hij is ingeschakeld, voert de stroombron een aantal controles uit om de juiste werking van het systeem en van alle aangesloten apparatuur te garanderen. In dit stadium wordt de gas test ook uitgevoerd om de juiste aansluiting te controleren van het gastoevoer systeem.

4.2 Test scherm

Wanneer het zijpaneel (draadkoffer) is geopend is het verboden om te lassen. Het test scherm verschijnt op het LCD display.

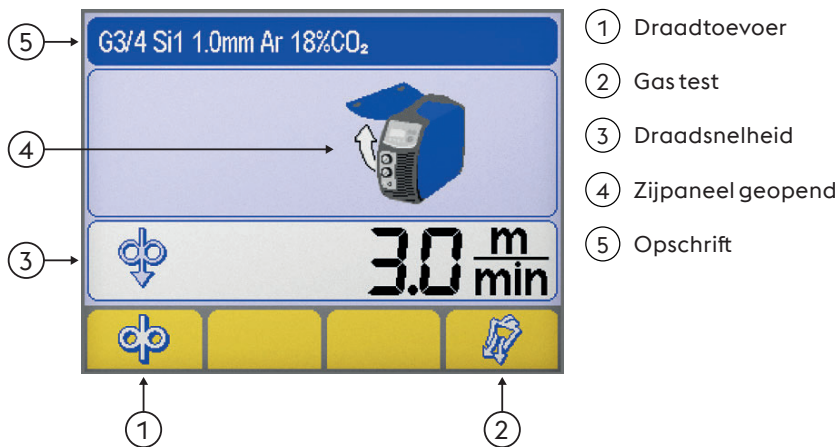

Draadtoevoer

Maakt handmatige draadtoevoer mogelijk zonder gastoevoer. Maakt het insteken van de draad in de toorts mogelijk tijdens de voorbereidingen van het lassen.



Gas test

Maakt het mogelijk de gasleiding te reinigen van onzuiverheden en om, zonder stroom verlies, de juiste inleidende gasdruk en de gas toevoer in te stellen.



Draadsnelheid

Maakt de regeling mogelijk van de snelheid van de draadtoevoer (tijdens het laden fase).

Minimaal	Maximaal	Fabrieksinstelling
0.5 m/min	22.0 m/min	3.0 m/min



Zijpaneel geopend



Opschrift

Maakt bepaalde belangrijke informatie zichtbaar die betrekking hebben op het geselecteerde proces.

4.3 Hoofd scherm

Maakt de controle mogelijk van het systeem en het las proces en laat de hoofd instellingen zien.

NL

4.4 Hoofdscherm MIG/MAG-proces

Basisscherm

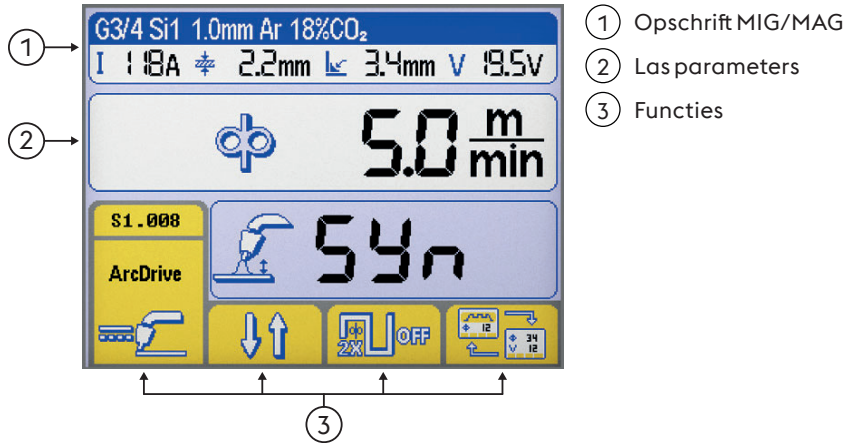

Grafisch scherm

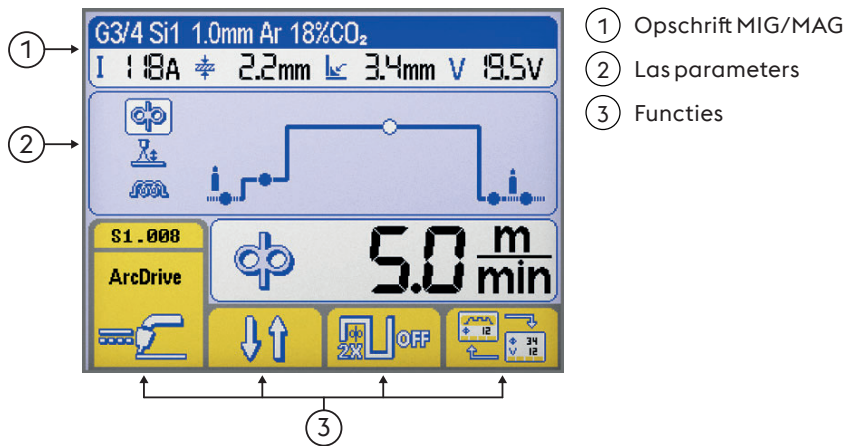

NL

Opschrift MIG/MAG

Maakt bepaalde belangrijke informatie zichtbaar die betrekking hebben op het geselecteerde proces.

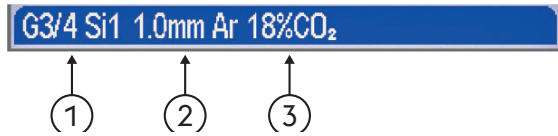

Geselecteerde synergische gebogen lijn

- ① type vul metaal
- ② Draad diameter
- ③ type gas

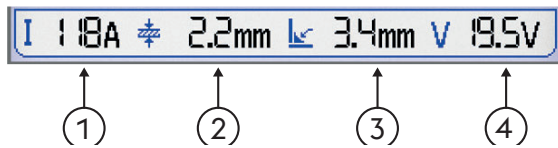

Las parameters

- ① Lasstroom
- ② Stukdikte
- ③ Hoeklasnaad "a"
- ④ Lasspanning

Las parameters (Basisscherm)

► Selecteer de gewenste parameter door de codeerknop in te drukken.

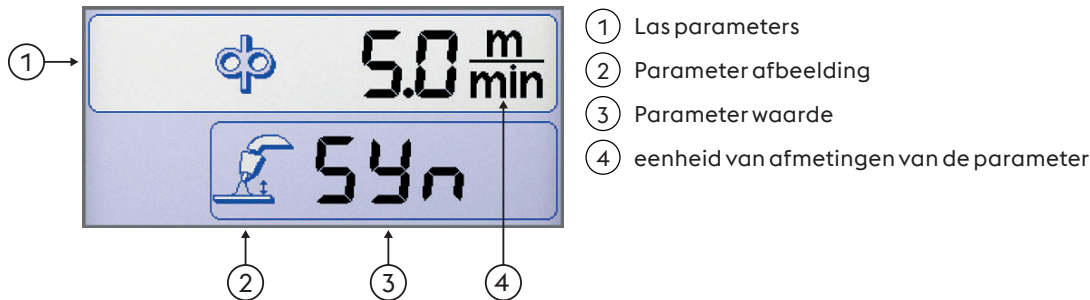

Las parameters (Grafisch scherm)

► Selecteer de gewenste parameter door de codeerknop in te drukken.

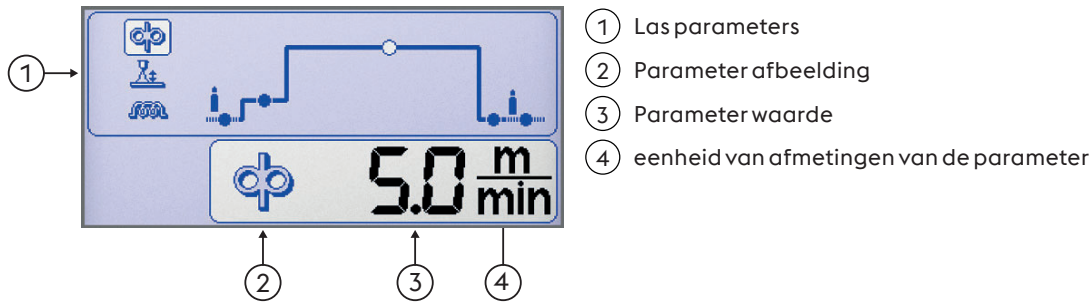

Functies

Maakt het mogelijk de belangrijkste proces functies en las methodes in te stellen.

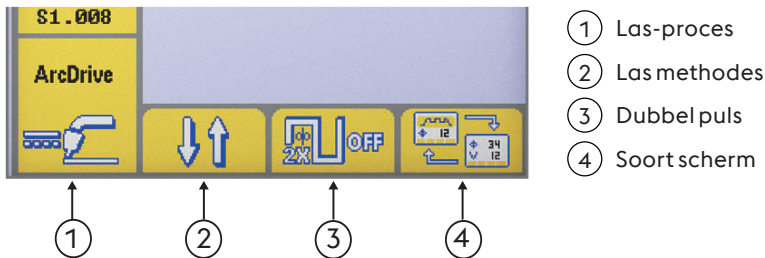

Las methodes

Maakt de keuze mogelijk van de las methode



2 Fasen

De knop indrukken activeert voor de gastoevoer geeft stroom naar de draad en laat hem vooruit gaan; als de knop wordt losgelaten worden de gasdruk en de stroomtoevoer uitgeschakeld.



4 Fasen

Bij 4 fasen zorgt de eerste indruk van de knop ervoor dat het gas gaat stromen met handmatige vooraf gas tijd, het loslaten van de knop activeert de stroomtoevoer naar de draad. Bij de volgende druk op de knop stopt de draad en laat het uiteindelijke proces van start gaan waardoor de stroom afloopt naar 0; laat u uiteindelijk de knop los dan zal de gastoevoer stoppen.



Crater filler

Zorgt ervoor dat u kunt lassen met drie verschillende kracht niveaus die u direct kunt kiezen en controleren door de knop op de toorts te gebruiken.

De eerste druk op de knop maakt dat de gastoevoer van start gaat, activeert de stroomtoevoer naar de draad en voedt hem met de vooraf ingestelde snelheid op de parameter (tijdens het instellen) en met de relatieve synergetische waarden van de las parameters.

Als de knop op de toorts wordt losgelaten, veranderen de snelheid van de draad en de relatieve synergie van de parameters automatisch naar de waarden zoals die op het controle paneel zijn ingesteld.

Bij de volgende druk op de knop van de toorts brengt de snelheid van de draad en de relatieve synergie van de parameters tot de vooraf ingestelde (tijdens de instelling) parameter waarden van de gaten vuller. Het loslaten van de knop op de toorts stopt de draadtoevoer en levert de energie voor het terug branden van de na-gas fase.



Dubbel puls



Dubbel puls actief



Dubbel puls niet actief

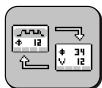

Soort scherm

Hiermee kan van weergave worden gewisseld tussen:



Basisscherm



Grafisch scherm

Synergetische lijnen scherm



Synergie

Hiermee kan een vooraf ingesteld lasprogramma (synergie) geselecteerd worden via onderstaande informatie

Selectie lasproces

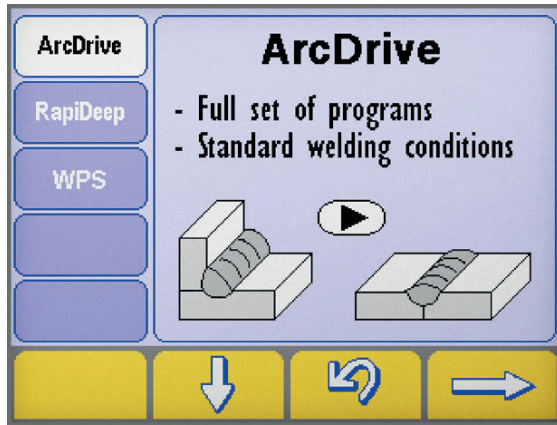

- ▶ Open het scherm "synergische programma's" door de toets ten minste een seconde ingedrukt te houden.
- ▶ Selecteer het gewenste proces via de toetsen e .
- ▶ Druk op de knop om naar de volgende stap te gaan.



Selectiescherm synergie Soort materiaal/Soort gas

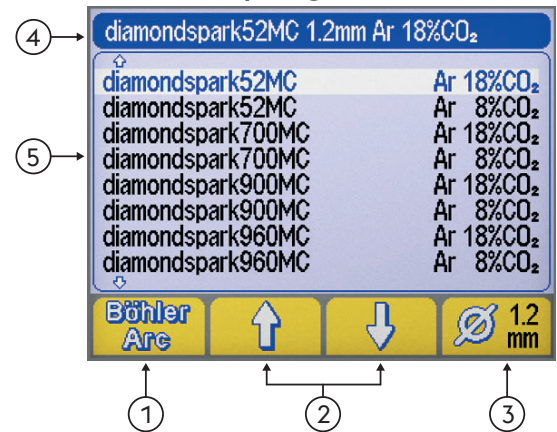

- 1 Lasprogramma (BöhlerArc/UniversalArc)
- 2 Selectie materiaal/gas
- 3 Draad diameter
- 4 Opschrift
- 5 Lasprogramma

NL

Böhler Arc Lasprogramma
Maakt de keuze mogelijk van de lasprogramma

BöhlerArc UniversalArc

Selectie materiaal/gas
Voor keuze van:

- type vul metaal
- type gas

Draad diameter
Kunt u kiezen uit de volgende draad diameter (mm).

① Draad diameter

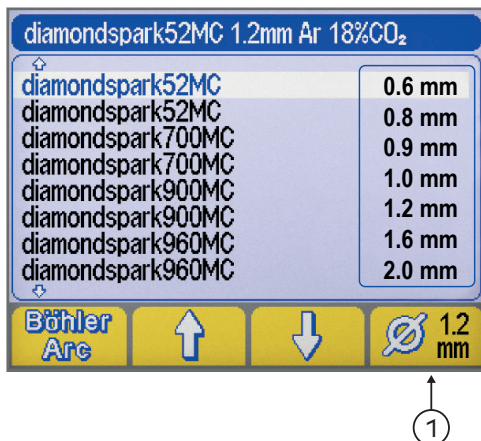



Opschrift

Maakt bepaalde belangrijke informatie zichtbaar die betrekking hebben op het geselecteerde proces.



NO PROGRAM

Geeft aan dat de geselecteerde synergische curve niet beschikbaar is of niet overeenkomt met de rest van de systeeminstellingen.

5. SETUP

5.1 Set up en instelling van de parameters

Zorgt voor het instellen en regelen van een serie extra parameters voor een betere en meer nauwkeurige controle van het lasstelsel.

De instelling van de parameters is afhankelijk van het geselecteerde lasproces en hebben een numerieke codering.

Beginnen met de set up

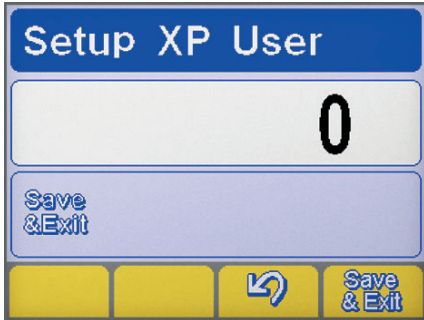



- ▶ Door de encoder-toets 5 seconden in te drukken.
- ▶ De toegang wordt bevestigd door de aanduiding 0 op het display.

Selectie en instelling van de gewenste parameters

- ▶ Draai de codeerknop totdat de numerieke code voor de parameter weergegeven wordt.
- ▶ Als de codeerknop op dat moment wordt ingedrukt wordt de ingestelde waarde voor deze parameter weergegeven en ingesteld.

Set up verlaten

- ▶ Om het gedeelte 'regeling' te verlaten de codeerknop opnieuw indrukken.
- ▶ Om de set up te verlaten, ga naar parameter "0" (opslaan en afsluiten) en de codeerknop in.
- ▶ Bevestig de handeling door de knop in te drukken .
- ▶ Om de wijziging op te slaan en de instelling te verlaten drukt u op de knop: .

5.1.1 Lijst parameters in de set up (MMA)

0 Opslaan en afsluiten



Om de wijzigingen op te slaan en de parameter te verlaten.

1 Reset



Om alle parameter weer op de fabrieksinstelling terug te brengen.

3 Hot start



Voor het regelen van de waarde van de hot start in MMA.

Voor een min of meer warme start in de fases van de ontsteking van de boog wat de startprocedure makkelijker maakt.

Basisch-elektrode

Minimaal	Maximaal	Fabrieksinstelling
0/uit	500%	80%

Cellulose-elektrode

Minimaal	Maximaal	Fabrieksinstelling
0/uit	500%	150%

CrNi-elektrode

Minimaal	Maximaal	Fabrieksinstelling
0/uit	500%	100%

Aluminium elektrode

Minimaal	Maximaal	Fabrieksinstelling
0/uit	500%	120%

Gietijzeren elektrode

Minimaal	Maximaal	Fabrieksinstelling
0/uit	500%	100%

7

Lasstroom

Voor het afstellen van de lasstroom.



Minimaal	Maximaal	Fabrieksinstelling
3 A	Imax	100 A

8

Arc force

Voor het regelen van de waarde van de Arc force in MMA.

Voor een min of meer krachtige dynamische reactie tijdens het lassen waardoor het werken voor de lasser gemakkelijker wordt.



Door de waarde van de arc-force te verhogen wordt de kans op vastkleven van de elektrode verlaagd.

Basisch-elektrode

Minimaal	Maximaal	Fabrieksinstelling
0/uit	500%	30%

Cellulose-elektrode

Minimaal	Maximaal	Fabrieksinstelling
0/uit	500%	350%

CrNi-elektrode

Minimaal	Maximaal	Fabrieksinstelling
0/uit	500%	30%

Aluminium elektrode

Minimaal	Maximaal	Fabrieksinstelling
0/uit	500%	100%

Gietijzeren elektrode

Minimaal	Maximaal	Fabrieksinstelling
0/uit	500%	70%

204

Dynamic power control (DPC)

Maakt het mogelijk de gewenste V/A karakteristiek te selecteren.



I=C Constante boog

De toe- of afname van de booglengte heeft geen effect op de lasstroom.

Aanbevolen voor elektrode: Basisch, Rutiel, Acid, Staal, Gietijzer

1:20 Afbouwende karakteristiek met slopeafstelling

De verlenging van de booglengte heeft een verlaging van de lasstroom tot gevolg (en omgekeerd) dit in de verhouding ampere staat tot voltage van 1 tot 20.

Aanbevolen voor elektrode: Cellulose, Aluminium

P=C Wet van behoud van energie

De verlenging van de booglengte veroorzaakt een verlaging van de lasstroom (en omgekeerd) en wel volgens de formule $V \cdot I = K$

Aanbevolen voor elektrode: Cellulose, Aluminium

312

Spanning booguitschakeling

Voor het instellen van de waarde van de spanning om de elektrische boog wordt uitgeschakeld.

Hierdoor worden de werkomstandigheden die zich voordoen beter beheerst.

Bij het puntlassen bijvoorbeeld zorgt een lage waarde van de spanning voor een minder grote vlam als de elektrode van het werkstuk wordt verwijderd waardoor spatten, verbranding en oxidatie van het werkstuk afnemen.

Worden er echter elektroden gebruikt waarvoor een hoge spanning noodzakelijk is, adviseren wij u een hoge drempelwaarde in te stellen om te voorkomen dat de boog tijdens het lassen dooft.



Stel de spanning voor het uitschakelen van de boog nooit hoger in dan nul lading spanning van de stroombron.

Basisch-elektrode

Minimaal	Maximaal	Fabrieksinstelling
0/uit	99.9 V	57.0 V

Cellulose-elektrode

Minimaal	Maximaal	Fabrieksinstelling
0/uit	99.9 V	70.0 V

399

Verplaatsingssnelheid

Hiermee wordt de snelheid ingesteld waarmee het laswerk wordt uitgevoerd.

Default cm/min: referentiesnelheid voor manueel lassen.

Syn: Sinergic waarde.



Minimaal	Maximaal	Fabrieksinstelling
1 cm/min	200 cm/min	15 cm/min

500 Machine-instelling



Maakt het kiezen van de gewenste grafische interface mogelijk.
Maakt de toegang mogelijk tot hogere instelling niveaus.
Raadpleeg het gedeelte "Interface personalisatie (Set up 500)"

Waarde	Gebruikersinterface	Waarde	Geselecteerd niveau
XE	eenvoudige modus	USER	Gebruiker
XA	Gevorderde modus	SERV	Service
XP	Professionele modus	vaBW	vaBW

551 Lock/unlock



Maakt het mogelijk de controle knoppen op het paneel te blokkeren en een bescherm code in te voeren.
Raadpleeg het gedeelte "Lock/unlock (Set up 551)".

552 Stapsgewijze aanpassing



Maakt aanpassing mogelijk van de verschillende stappen van de up-down toetsen.

Minimaal	Maximaal	Fabrieksinstelling
0/uit	10	10

601 Stapsgewijze regeling



Maakt het stapsgewijze regelen van de parameter met de persoonlijke instellingen van de lasser mogelijk.

Minimaal	Maximaal	Fabrieksinstelling
1	lmax	1

602 Externe parameter CH1, CH2, CH3, CH4



Maakt de besturing mogelijk van de externe parameter 1, 2, 3, 4 (minimale waarde, maximale waarde, waarde ingesteld door de fabriek, geselecteerde parameter).

Raadpleeg het gedeelte "Beheer van externe controle (Set up 602)".

705 Afstelling weerstand circuit



Voor het afstellen van de apparatuur.

Raadpleeg het gedeelte "Afstelling weerstand circuit (set up 705)".

751 Stroom aflezen



Toont de werkelijke waarde van de lasstroom.

752 Voltage aflezen



Toont de werkelijke waarde van het las voltage.

768 Meting warmtetoever Hl



Hiermee kan de waarde van de warmtetoevermeting tijdens het lassen worden afgelezen.

801 Bewaken van limieten



Maakt het instellen mogelijk van de waarschuwingsgrens en van de bewaking van de limieten.

Maakt het mogelijk dat het lasproces wordt gecontroleerd door het instellen van waarschuwingslimieten en bewakingslimieten voor de voornaamste meetbare parameters.

Maakt een accurate controle mogelijk van de diverse las fases.

Raadpleeg het gedeelte "Bewaken van limieten (Set up 801)".

5.1.2 Lijst parameters in setup (TIG)

0 Opslaan en afsluiten



Om de wijzigingen op te slaan en de parameter te verlaten.

1 Reset



Om alle parameter weer op de fabrieksinstelling terug te brengen.

7 Lasstroom



Voor het afstellen van de lasstroom.

Minimaal	Maximaal	Fabrieksinstelling
3 A	I _{max}	100 A

399 Verplaatsingsnelheid



Hiermee wordt de snelheid ingesteld waarmee het laswerk wordt uitgevoerd.

Default cm/min: referentiesnelheid voor manueel lassen.

Syn: Sinergic waarde.

Minimaal	Maximaal	Fabrieksinstelling
1 cm/min	200 cm/min	10 cm/min

500 Machine-instelling



Maakt het kiezen van de gewenste grafische interface mogelijk.

Maakt de toegang mogelijk tot hogere instelling niveaus.

Raadpleeg het gedeelte "Interface personificatie (Set up 500)"

Waarde	Gebruikersinterface	Waarde	Geselecteerd niveau
XE	eenvoudige modus	USER	Gebruiker
XA	Gevorderde modus	SERV	Service
XP	Professionele modus	vaBW	vaBW

551 Lock/unlock



Maakt het mogelijk de controle knoppen op het paneel te blokkeren en een bescherm code in te voeren.

Raadpleeg het gedeelte "Lock/unlock (Set up 551)".

552 Stapsgewijze aanpassing



Maakt aanpassing mogelijk van de verschillende stappen van de up-down toetsen.

Minimaal	Maximaal	Fabrieksinstelling
0/uit	10	10

601 Stapsgewijze regeling



Maakt het stapsgewijze regelen van de parameter met de persoonlijke instellingen van de lasser mogelijk.

Minimaal	Maximaal	Fabrieksinstelling
1	I _{max}	1

602 Externe parameter CH1, CH2, CH3, CH4



Maakt de besturing mogelijk van de externe parameter 1, 2, 3, 4 (minimale waarde, maximale waarde, waarde ingesteld door de fabriek, geselecteerde parameter).

Raadpleeg het gedeelte "Beheer van externe controle (Set up 602)".

705 Afstelling weerstand circuit



Voor het afstellen van de apparatuur.

Raadpleeg het gedeelte "Afstelling weerstand circuit (set up 705)".

751 Stroom aflezen



Toont de werkelijke waarde van de lasstroom.

752 Voltage aflezen



Toont de werkelijke waarde van het las voltage.

758 Bewegingsnelheid van de robot

Maakt het mogelijk dat de bewegingsnelheid van de arm van een robot of van een automatisch apparaat wordt getoond.

768 Meting warmtetoever H1

Hiermee kan de waarde van de warmtetoevermeting tijdens het lassen worden afgelezen.

801 Bewaken van limieten

Maakt het instellen mogelijk van de waarschuwingsgrens en van de bewaking van de limieten.
 Maakt het mogelijk dat het lasproces wordt gecontroleerd door het instellen van waarschuwinglimieten en bewakingslimieten voor de voornaamste meetbare parameters.
 Maakt een accurate controle mogelijk van de diverse las fases.
 Raadpleeg het gedeelte "Bewaken van limieten (Set up 801)".

5.1.3 Lijst parameters in setup (MIG/MAG)
0
Opslaan en afsluiten

Om de wijzigingen op te slaan en de parameter te verlaten.

1
Reset

Om alle parameter weer op de fabrieksinstelling terug te brengen.

2
Las programma's

MIG/MAG-Standaard:

Zorgt voor de keuze van het handmatig MIG (◇ Off) of synergisch MIG proces (◇ 6) door het instellen van het soort materiaal dat gelast moet worden.

Pulserend MIG/MAG:

Zorgt voor de keuze van het of synergisch MIG proces (◇ 6) door het instellen van het soort materiaal dat gelast moet worden.

Zorgt voor de keuze van het CC/CV proces.

3
Draadsnelheid

Maakt de regeling mogelijk van de snelheid van de draadtoevoer.

Minimaal	Maximaal	Fabrieksinstelling
0.5 m/min	22.0 m/min	-

4
Stroom

Voor het afstellen van de lasstroom.

Minimaal	Maximaal
3 A	I _{max}

5
Stukdikte

Maakt het mogelijk dat de dikte van het deel dat wordt gelast ingesteld wordt.
 Maakt de instelling mogelijk van het systeem doormiddel van het reguleren van het te lassen deel.

6
Hoeklasnaad "a"

Hiermee wordt de diepte ingesteld van de lasnaad bij een hoekaansluiting.

10
Voor gas stroom tijd

Om de gasstroom vóór het ontsteken van de boog in te stellen en te regelen.
 Om de toorts met gas te vullen en de werkplek voor het lassen in gereedheid te brengen.

Minimaal	Maximaal	Fabrieksinstelling
0/uit	99.9 s	0.1 s

11 Soft start



Om de draadsnelheid in te stellen en te regelen vóór u de boog ontsteekt.
Voor een ontsteking met lagere snelheid en dus soepeler en met minder spetters.

Minimaal	Maximaal	Fabrieksinstelling
10 %	100 %	50 %

12 Motor opbouw



Voor een geleidelijke overgang van de draadsnelheid bij ontsteken en lassen.

Minimaal	Maximaal	Fabrieksinstelling
0/uit	1.0 s	0/uit

15 Burn back



Voor de regeling van de tijd dat de draad brandt waardoor vastplakken aan het einde van het lassen wordt voorkomen.

Voor de regeling van de lengte van het stuk draad buiten de toorts.

Minimaal	Maximaal	Fabrieksinstelling
-2.00	+2.00	0/syn

16 Na-gas stroomtijd



Voor het regelen van de lasstroom aan het eind van het lassen.

Minimaal	Maximaal	Fabrieksinstelling
0/uit	99.9 s	2.0 s

19 Duty cycle (dubbelpuls)



Maakt het regelen van de duty cycle in dubbelpuls mogelijk.

Minimaal	Maximaal	Fabrieksinstelling
10 %	90 %	50 %

20 Dubbel puls



Maakt het regelen van de breedte van de pulsatie mogelijk.

Minimaal	Maximaal	Fabrieksinstelling
0 %	100 %	±25 %

Minimaal	Maximaal	Fabrieksinstelling
0.5 m/min	22 m/min	2.5 m/min

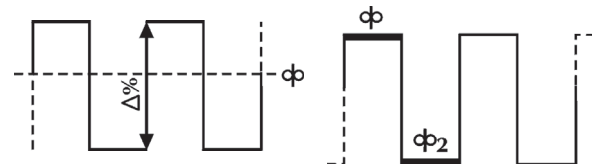

21 Puls frequentie (dubbelpuls)



Maakt het regelen van de cyclus, dat wil zeggen van de impuls herhalingscyclus.

Maakt het mogelijk de frequentie van de impuls te regelen.

Minimaal	Maximaal	Fabrieksinstelling
0.1 Hz	5.0 Hz	2.0 Hz

22 Secundaire voltage (dubbelpuls)



Maakt de regeling mogelijk van het voltage van het secundaire pulsering niveau.

Hierdoor kan grotere boog vastheid worden verkregen gedurende de verschillende fases van het pulseren.

Minimaal	Maximaal	Fabrieksinstelling
-5.0	+5.0	0/syn

23 Puls afbouwend (dubbelpuls)



Maakt de instelling van up slope tijd mogelijk tijdens het puls lassen.

Minimaal	Maximaal	Fabrieksinstelling
1 %	100 %	50 %

24 Bilevel (4T - crater filler)



Voor het regelen van de secundaire draadsnelheid bij het lassen in bilevel.

Als de lasser de knop snel indrukt en weer loslaat wordt er overgegaan op “φ₂”.

Door de knop snel in te drukken en weer los te laten wordt er weer overgegaan op “φ” enzovoorts.

Minimaal	Maximaal	Fabrieksinstelling
1 %	200 %	0/uit

25 Aanvankelijke vermeerdering

Maakt het mogelijk de waarde van de draadtoevoer snelheid te regelen gedurende de eerste 'krater vulling' lasfase.

Hierdoor kan de energie aanvoer worden verhoogd wanneer dat noodzakelijk is bij dit deel van het werk in deze fase (het materiaal is nog koud), is om een gelijkmatige smelting te krijgen meer hitte nodig.

Minimaal	Maximaal	Fabrieksinstelling
20 %	200 %	120 %

26 Crater filler

Maakt het mogelijk de draadtoevoer snelheid te regelen tijdens de slot fase van het lassen.

Hierdoor kan de energie aanvoer worden verminderd wanneer dat noodzakelijk is bij dit deel van het werk in deze fase als het materiaal al heel heet is, zodoende wordt het risico op ongewilde deformaties verkleind.

Minimaal	Maximaal	Fabrieksinstelling
20 %	200 %	80 %

27 Timing aanvankelijk increment

Hiermee wordt de aanvankelijke incrementtijd ingesteld.

Voor het automatiseren van de functie voor vullen van de krater.

Minimaal	Maximaal	Fabrieksinstelling
0.1 s	99.9 s	0/uit

28 Timing krater vullen

Hiermee wordt de tijd voor vullen van de krater ingesteld.

Voor het automatiseren van de functie voor vullen van de krater.

Minimaal	Maximaal	Fabrieksinstelling
0.1 s	99.9 s	0/uit

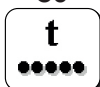
30 Puntlassen

Zorgt ervoor de plaatselijk las procedure uit te voeren en stelt een lastijd in.

Minimaal	Maximaal	Fabrieksinstelling
0.1 s	99.9 s	0/uit

31 Pauze punt

Voor het activeren van het proces "pauze punt" en om een rusttijd tussen een las en de volgende las te bepalen.

Minimaal	Maximaal	Fabrieksinstelling
0.1 s	99.9 s	0/uit

32 Secundaire voltage (weerstand bij wisselstroom) (Bilevel MIG)

Maakt de regeling mogelijk van het voltage van het secundaire pulsering niveau.

Hierdoor kan grotere boog vastheid worden verkregen gedurende de verschillende fases van het pulseren.

Minimaal	Maximaal	Fabrieksinstelling
-5.0	+5.0	0/syn

33 Secundaire inductantie (weerstand bij wisselstroom) (Bilevel MIG)

Maakt de regeling mogelijk van het weerstand van het secundaire pulsering niveau.

Maakt het mogelijk een snellere of langzamere boog te krijgen door de bewegingen van de lasser en de natuurlijke las instabiliteit te compenseren.

Lage weerstand = terugwerkende boog (meer spetters).

Hoge weerstand = minder terugwerkende boog (minder spetters).

Minimaal	Maximaal	Fabrieksinstelling
-30	+30	0/syn

34 Aanvankelijke incrementopbouw

Om een geleidelijke overgang in te stellen van aanvankelijk increment naar lassen.

Minimaal	Maximaal	Fabrieksinstelling
0 s	10 s	0/uit

35 Rampa crater filler



Om een geleidelijke overgang in te stellen van lassen naar vullen van de krater.

Minimaal	Maximaal	Fabrieksinstelling
0 s	10 s	0/uit

202 Inductantie (weerstand bij wisselstroom)



Maakt het regelen mogelijk van de weerstand van het las circuit.

Maakt het mogelijk een snellere of langzamere boog te krijgen door de bewegingen van de lasser en de natuurlijke las instabiliteit te compenseren.

Lage weerstand = terugwerkende boog (meer spetters).

Hoge weerstand = minder terugwerkende boog (minder spetters).

Minimaal	Maximaal	Fabrieksinstelling
-30	+30	0/syn

331 Gecompenseerde gemiddelde spanning



Hiermee wordt de lasspanning ingesteld.

398 Referentieconstante verplaatsingsnelheid



Referentieconstante voor alle lasprocessen

Waarde van de verplaatsingsnelheid van de toorts op basis waarvan het systeem de lasparameterberekeningen uitvoert

399 Verplaatsingsnelheid



Hiermee wordt de snelheid ingesteld waarmee het laswerk wordt uitgevoerd.

Default cm/min: referentiesnelheid voor manueel lassen.

Syn: Sinergic waarde.

Minimaal	Maximaal	Fabrieksinstelling
syn min	syn max	35 cm/min

500 Machine-instelling



Maakt het kiezen van de gewenste grafische interface mogelijk.

Maakt de toegang mogelijk tot hogere instelling niveaus.

Raadpleeg het gedeelte "Interface personificatie (Set up 500)"

Waarde	Gebruikersinterface
XE	eenvoudige modus
XA	Gevorderde modus
XP	Professionele modus

Waarde	Geselecteerd niveau
USER	Gebruiker
SERV	Service
vaBW	vaBW

551 Lock/unlock



Maakt het mogelijk de controle knoppen op het paneel te blokkeren en een bescherm code in te voeren.

Raadpleeg het gedeelte "Lock/unlock (Set up 551)".

552 Stapsgewijze aanpassing



Maakt aanpassing mogelijk van de verschillende stappen van de up-down toetsen.

Minimaal	Maximaal	Fabrieksinstelling
0/uit	10	10

601 Stapsgewijze regeling



Maakt het stapsgewijze regelen van de parameter met de persoonlijke instellingen van de lasser mogelijk.

Functionaliteit bestuurd door toorts omhoog / omlaag-knop.

Minimaal	Maximaal	Fabrieksinstelling
1	lmax	1

602 Externe parameter CH1, CH2, CH3, CH4



Maakt de besturing mogelijk van de externe parameter 1, 2, 3, 4 (minimale waarde, maximale waarde, waarde ingesteld door de fabriek, geselecteerde parameter).

Raadpleeg het gedeelte "Beheer van externe controle (Set up 602)".

606 U/D toorts

Maakt de besturing mogelijk van de externe parameter (U/D).

Waarde	Fabrieksinstelling	Callback-functie
0/uit	-	uit
1/I1	X	Stroom
	-	Programma ontsluiten

612 Instelling DgMig toorts

Hiermee kunnen de kanalen van de digitale toorts worden beheerd.

Waarde	Fabrieksinstelling	Callback-functie
0/uit	-	uit
1/I1	-	Stroom
2/ 	-	Programma ontsluiten
3/CH3	-	CH3
4/CH4	-	CH4
5/STD	X	STD

653 Draadsnelheid

Maakt de regeling mogelijk van de snelheid van de draadtoevoer (tijdens het laden fase).

Minimaal	Maximaal	Fabrieksinstelling
0.5 m/min	22.0 m/min	3.0 m/min

705 Afstelling weerstand circuit

Voor het afstellen van de apparatuur.

Raadpleeg het gedeelte "Afstelling weerstand circuit (set up 705)".

751 Stroom aflezen

Toont de werkelijke waarde van de lasstroom.

752 Voltage aflezen

Toont de werkelijke waarde van het las voltage.

755 Gasstroom aflezen

Maakt het tonen van de werkelijke waarde van de gasstroom mogelijk.

757 Draadsnelheid aflezen

Encoder motor 1 inlezen.

758 Bewegingssnelheid van de robot

Maakt het mogelijk dat de bewegingssnelheid van de arm van een robot of van een automatisch apparaat wordt getoond.

760 Stroom aflezen (motor 1)

Toont de werkelijke waarde van de motorstroom (motor 1).

768 Meting warmtetoevoer HI

Hiermee kan de waarde van de warmtetoevoermeting tijdens het lassen worden afgelezen.

NL

770 Meting van de neersmeltsnelheid



Hiermee kan de meting van de neersmeltsnelheid worden weergegeven.

801 Bewaken van limieten



Maakt het instellen mogelijk van de waarschuwingsgrens en van de bewaking van de limieten. Maakt het mogelijk dat het lasproces wordt gecontroleerd door het instellen van waarschuwingslimieten en bewakingslimieten voor de voornaamste meetbare parameters. Maakt een accurate controle mogelijk van de diverse las fases. Raadpleeg het gedeelte "Bewaken van limieten (Set up 801)".

5.2 Specifieke gebruiksprocedures van de parameters

5.2.1 7 segmenten display personalificatie

Hiermee kan de waarde van een parameter constant op het 7-segmenten-display worden weergegeven.

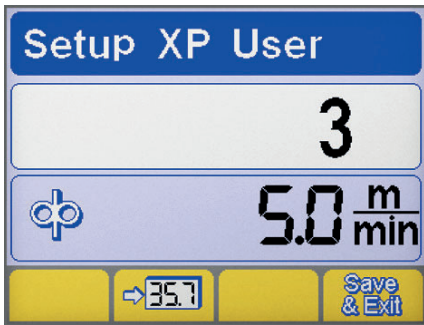

- ▶ Begin in set-up door de decoder knop minstens 5 seconden in te drukken.
- ▶ Selecteer de gewenste parameter door de decoder.
- ▶ Sla de geselecteerde parameter op in het 7 segmenten display door de knop in te drukken .
- ▶ Sla het op en verlaat het huidige scherm door de knop in te drukken .

5.2.2 Interface personalificatie (Set up 500)

Maakt het mogelijk dat de parameters worden aangepast op het hoofdmenu.

500 Machine-instelling



Maakt het kiezen van de gewenste grafische interface mogelijk.

Waarde	Gebruikersinterface
XE	eenvoudige modus
XA	Gevorderde modus
XP	Professionele modus

MODUS XE

MIG/MAG	
Las parameters	
Functies	

MODUS XA

MIG/MAG	
Las parameters	
Functies	

NL

MODUS XP

MIG/MAG

Las parameters	
Functies	

5.2.3 Lock/unlock (Set up 551)

Maakt het mogelijk de controle knoppen op het paneel te blokkeren en een bescherm code in te voeren.

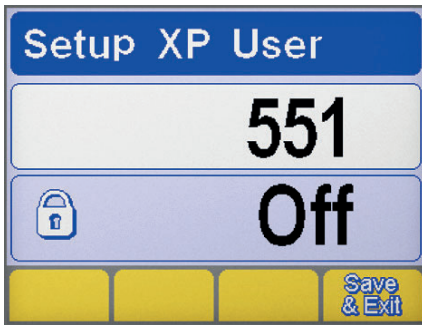
Selectie parameter

- ▶ Begin in set-up door de decoder knop minstens 5 seconden in te drukken.
- ▶ Selecteer de gewenste parameter (551).
- ▶ Activeer de regeling van de geselecteerde parameter door de decoder knop in te drukken.

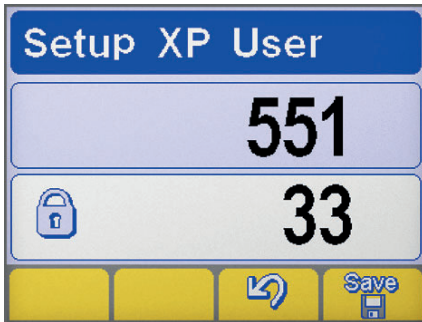
Wachtwoord instellen

- ▶ Stel een numerieke code (paswoord) in door de decoder te draaien.
- ▶ Druk op de encoder-toets om de bewerking te bevestigen.
- ▶ Bevestig de handeling door de knop in te drukken .
- ▶ Om de wijziging op te slaan drukt u op de knop: .

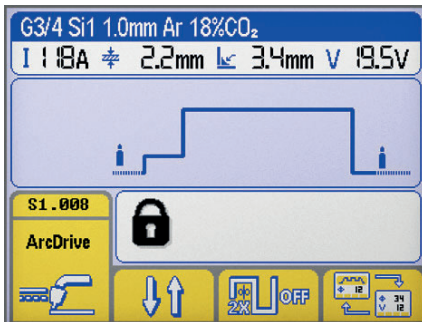
Functies van het paneel

- ▶ Tijdelijke toegang tot de functies op het paneel (5 minuten) door de decoder te draaien en het juiste paswoord in te voeren.
- ▶ Druk op de encoder-toets om de bewerking te bevestigen.
- ▶ Open het controle paneel definitief door in de set-up te beginnen (volg de instructies die hierboven gegeven zijn) en breng parameter 551 terug naar 'af'.
- ▶ Druk op de encoder-toets om de bewerking te bevestigen.
- ▶ Om de wijziging op te slaan drukt u op de knop: .

5.2.4 Beheer van externe controle (Set up 602)

Maakt de besturing mogelijk van de externe parameter 2 (minimale waarde, maximale waarde, waarde ingesteld door de fabriek, geselecteerde parameter).

Selectie parameter

- ▶ Begin in set-up door de decoder knop minstens 5 seconden in te drukken.
- ▶ Selecteer de gewenste parameter (602).
- ▶ Begin in het "Externe controle beheer" scherm door de decoder knop in te drukken.

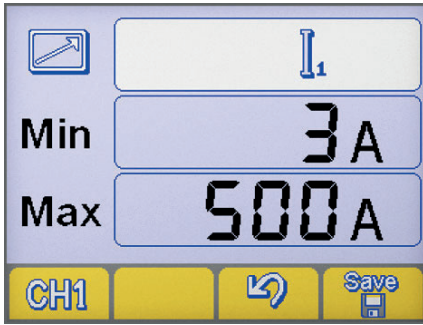

Beheer van externe controle

- ▶ Selecteer de gewenste RC afstandsbediening uitgang (CH1, CH2, CH3, CH4) door de knop in te drukken.
- ▶ Selecteer de gewenste parameter (Min-Max - parameter) door de knop van de decoder in te drukken.
- ▶ Pas de gewenste parameter aan (Min-Max - parameter) door de decoder te draaien.
- ▶ Om de wijziging op te slaan drukt u op de knop:
- ▶ Bevestig de handeling door de knop in te drukken

5.2.5 Afstelling weerstand circuit (set up 705)

Hiermee kan de generator worden afgesteld op de weerstand van het huidige lascircuit.

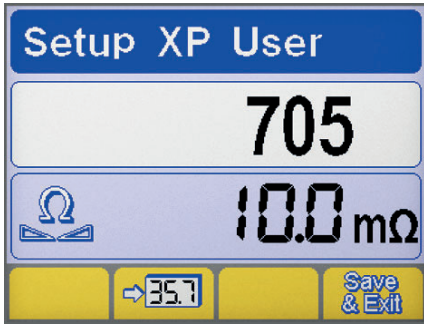

Selectie parameter

- ▶ Begin in set-up door de decoder knop minstens 5 seconden in te drukken.
- ▶ Selecteer de gewenste parameter (705).
- ▶ Activeer de regeling van de geselecteerde parameter door de decoder knop in te drukken.
- ▶ Sluit de generator aan op het lascircuit (bank of werkstuk).
- ▶ Verwijder de dop om de mondstukhouder van de toorts bloot te leggen. (MIG/MAG)

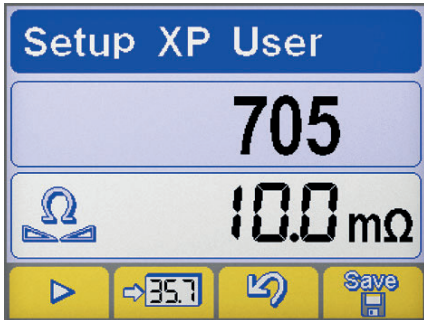

Afstelling

- ▶ Breng draadpunt en lasstuk elektrisch met elkaar in contact. (MIG/MAG)
- ▶ Druk op de knop om de procedure te starten.
- ▶ Houd het contact ten minste een seconde aan.
- ▶ De op het display weergegeven waarde wordt bijgewerkt nadat de afstelling is uitgevoerd.
- ▶ Bevestig de handeling door de knop in te drukken
- ▶ Bevestig de handeling door de knop in te drukken
- ▶ Om de wijziging op te slaan en de instelling te verlaten drukt u op de knop:

5.2.6 Bewaken van limieten (Set up 801)

Maakt het instellen mogelijk van de waarschuwingsgrenzen en van de bewaking van de limieten.

Maakt het mogelijk dat het lasproces wordt gecontroleerd door het instellen van waarschuwinglimieten en bewakingslimieten voor de voornaamste meetbare parameters.

Maakt een accurate controle mogelijk van de diverse las fases.

Raadpleeg het gedeelte "Bewaken van limieten (Set up 801)".



- Lasstroom
- Gasstroom aflezen
- Stroom aflezen (motor 1)
- Koelvloeistofstroom inlezen
- Temperatuur koelvloeistof aflezen

- Lasspanning
- Bewegingsnelheid van de robot
- Stroom aflezen (motor 2)
- Draadsnelheid aflezen

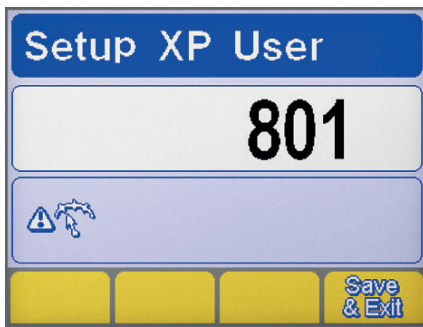

Selectie parameter

- ▶ Begin in set-up door de decoder knop minstens 5 seconden in te drukken.
- ▶ Selecteer de gewenste parameter (801).
- ▶ Begin in het Bewaak de limieten scherm door de decoder knop in te drukken.

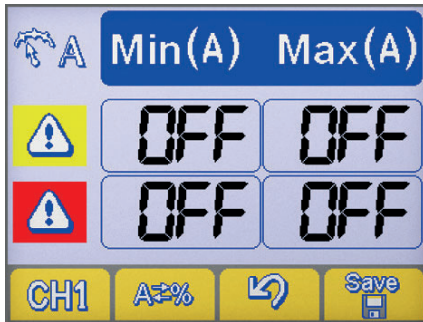

Selectie van de parameter

- ▶ Selecteer de gewenste parameter door knop in te drukken set **CH1**.
- ▶ Selecteer de instel methode van de bewakingslimieten door de knop in te drukken **A=%**.

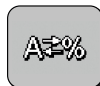

Machine-instelling



Absolute waarde



Waarde percentage

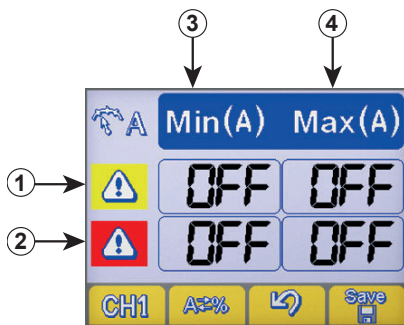

Instelling waarschuwingsgrenzen

- 1 Waarschuwinglimieten lijn
- 2 Alarm limieten lijn
- 3 Minimale niveaus kollom
- 4 Maximale niveaus kollom

- ▶ Selecteer de gewenste box door de decoder sleutel in te drukken (de geselecteerde box wordt getoond in spiegelbeeld).
- ▶ Pas het niveau van de geselecteerde limiet door de decoder te draaien.
- ▶ Om de wijziging op te slaan drukt u op de knop: **Save**.



Wanneer u één van de waarschuwinglimieten overschrijdt verschijnt er een visueel signaal op het controle paneel.



Wanneer u één van de alarm limieten overschrijdt verschijnt er een visueel signaal op het controle paneel en volgt de onmiddellijke blokkade van de las handeling.



Het is mogelijk om het begin en het einde in te stellen van de las filters om foutieve signalen te voorkomen gedurende het aansteken en uitgaan van de boog (raadpleeg het gedeelte Set-up - Parameters 802-803-804).

6. ACCESSOIRES

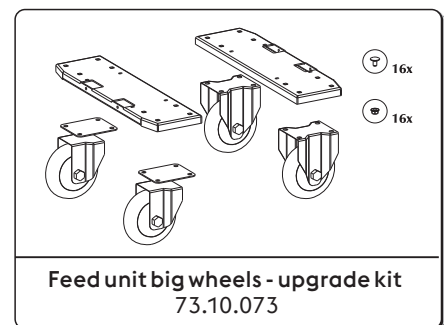
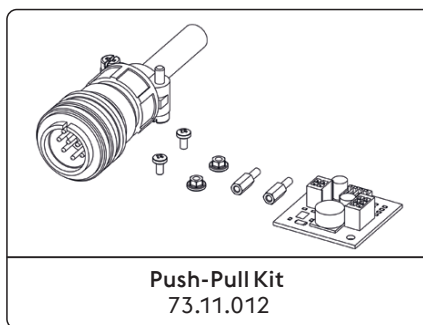
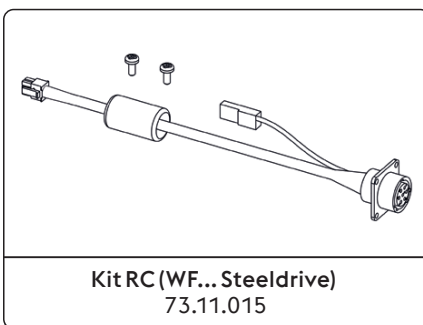

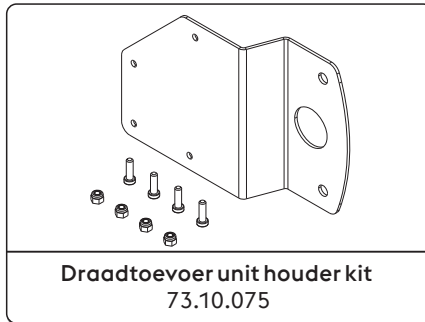
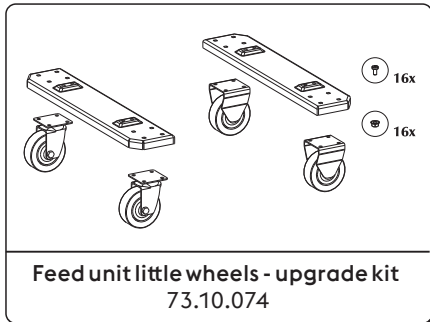

*Factory assemblage

Raadpleeg het gedeelte "Het installeren kit/accessoires".

7. ONDERHOUD



De normale onderhoud werkzaamheden moeten worden uitgevoerd volgens de richtlijnen die de fabrikant heeft verstrekt. Als de machine is ingeschakeld moeten alle ingangspunten en panelen zijn gesloten. De installatie mag op geen enkele manier worden gewijzigd. Voorkom ophoping van metaalstof bij of op het koelrooster.



Iedere onderhoud beurt dient te worden gedaan door gekwalificeerd personeel. Bij reparatie of vervanging van een onderdeel in de machine door onbevoegd personeel vervalt de garantie. De reparatie of vervanging van een onderdeel in de machine dient te worden gedaan door gekwalificeerd personeel.



Schakel de stroomtoevoer altijd uit voor u onderhoud pleegt.

7.1 Controleer de stroombron regelmatig als volgt



Reinig de machine aan de binnenkant door hem uit te blazen en af te borstelen met een zachte borstel. Controleer de elektrische aansluitingen en de kabels.

7.2 Odpovědnost



Als geen regelmatig onderhoud wordt uitgevoerd, vervalt de garantie en wordt de fabrikant van alle aansprakelijkheid ontheven. De fabrikant wijst ieder verantwoordelijkheid af wanneer de gebruiker zich niet houdt aan de volgende richtlijnen. In geval van twijfel of problemen aarzel niet contact op te nemen met uw leverancier.

8. ALARM CODES



ALARM

De tussenkomst van een alarm of de overschrijding van een kritieke waarschuwingsgrens veroorzaakt een visueel signaal op het bedieningspaneel en de onmiddellijke stopzetting van de laswerkzaamheden.



Let op!

De overschrijding van een waarschuwingsgrens veroorzaakt een visueel signaal op het bedieningspaneel maar de laswerkzaamheden kunnen worden voortgezet.

Hieronder volgt een lijst van alle alarmen en waarschuwingsgrenzen met betrekking tot het systeem.

E01	Overtemperatuur		E02	Overtemperatuur	
E05	Overstroom		E07	Storing voedingssysteem van draadtoevoermotor	
E08	Geblokkeerde motor		E10	Overstroom vermogensmodule (Inverter)	
E12.1	Communicatiefout WF1		E13	Communicatiefout (FP)	

 E14.xx	Programma niet geldig de subcode van de fout geeft het nummer van de verwijderde taak aan		 E15	Programma niet geldig	
 E16.1	Communicatiefout RI 1000/2000/3000 (CAN bus)		 E16.2	Communicatiefout RI 3000 (Modbus)	
 E16.3	Communicatiefout RI 1000/2000		 E18.xx	Programma niet geldig de subcode van de fout geeft het nummer van de verwijderde taak aan	
 E19	Fout in systeemconfiguratie		 E19.1	Fout in systeemconfiguratie	
 E19.11	Fout in systeemconfiguratie (WF)		 E20	Defect geheugen	
 E21	Gegevensverlies		 E23	Niet aanwezige lasprogramma's	
 E27	Defect geheugen (RTC)		 E32	Gegevensverlies	
 E33.1	Fout in systeemconfiguratie (LCD 3.5")		 E33.3	Communicatiefout (ACTIVATION KEY)	
 E33.4	Communicatiefout (ACTIVATION KEY)		 E40	Storing systeemvoeding	
 E43	Geen koelvloeistof		 E44	Geen gas	
 E48	Geen draad (Automatisering en robot besturing)		 E50	Draad vastgeplakt (Automatisering en robot besturing)	
 E54	Stroomniveau overschreden (Onderste grens)		 E55	Stroomniveau overschreden (Bovenste grens)	
 E56	Spanningsniveau overschreden (Onderste grens)		 E57	Spanningsniveau overschreden (Bovenste grens)	
 E58	Stromingsniveau gas overschreden (Onderste grens)		 E59	Stromingsniveau gas overschreden (Bovenste grens)	
 E62	Stroomniveau overschreden (Onderste grens)		 E63	Stroomniveau overschreden (Bovenste grens)	
 E64	Spanningsniveau overschreden (Onderste grens)		 E65	Spanningsniveau overschreden (Bovenste grens)	
 E66	Stromingsniveau gas overschreden (Onderste grens)		 E67	Stromingsniveau gas overschreden (Bovenste grens)	

E71	Overtemperatuur koelvloeistof		E74	Stroomniveau motor 1 overschreden	
E76	Stromingsniveau koelvloeistof overschreden		E77	Temperatuurniveau koelvloeistof	
E80	Geen draad (wire end)		E81	Overstroom (pomp WU)	
E82	Communicatiefout (WU)		E83	Pomp geblokkeerd	
E99.2	Systeem configuratie alarm (inverter)		E99.3	Systeem configuratie alarm (FP)	
E99.4	Systeem configuratie alarm (FP)		E99.5	Systeem configuratie alarm (FP)	
E99.6	Systeem configuratie alarm		E99.11	Defect geheugen	

9. MEEST VOORKOMENDE VRAGEN EN OPLOSSINGEN

Draadtoevoer blokkeert

Vraag

- » Toortsknop defect

- » Kapotte of versleten rollen.

- » Draadaanvoer onderdeel kapot.

- » Toorts liner beschadigd.

- » Geen stroom op de draadtoevoer unit.

- » Draad op de spoel in de knoop.

- » Toortsmondstuk gesmolten(draad vastgeplakt).

Oplossing

- » Vervang het defecte onderdeel.
- » Neem contact op met uw leverancier om de machine te laten repareren.

- » Vervang de rollen.

- » Vervang het defecte onderdeel.
- » Neem contact op met uw leverancier om de machine te laten repareren.

- » Vervang het defecte onderdeel.
- » Neem contact op met uw leverancier om de machine te laten repareren.

- » Controleer de aansluiting op de stroombron.
- » Raadpleeg de paragraaf "Aansluitingen".
- » Neem contact op met uw leverancier om de machine te laten repareren.

- » Haal de draad uit de knoop of verwissel de spoel.

- » Vervang het defecte onderdeel.

Onregelmatige draadtoevoer

Vraag

- » Toortsknop defect

- » Kapotte of versleten rollen.

- » Draadaanvoer onderdeel kapot.

- » Toorts liner beschadigd.

Oplossing

- » Vervang het defecte onderdeel.
- » Neem contact op met uw leverancier om de machine te laten repareren.

- » Vervang de rollen.

- » Vervang het defecte onderdeel.
- » Neem contact op met uw leverancier om de machine te laten repareren.

- » Vervang het defecte onderdeel.
- » Neem contact op met uw leverancier om de machine te laten repareren.

» Haspelkoppeling of rolblokkering onderdeel niet goed afgesteld.

» Koppeling losmaken.
» Druk op de rollen verhogen.

Slakken

Vraag

» Slakken niet geheel verwijderd.
» Diameter van de elektrode te groot.
» Onjuiste voorbereiding van de werkstukken.
» Wijze van lassen niet correct.

Oplossing

» Maak de stukken grondig schoon alvorens ze te lassen.
» Gebruik een elektrode met een kleinere diameter.
» Vergroot de lasopening.
» Verminder de afstand tussen de elektrode en het werkstuk.
» Beweeg regelmatig tijdens het lassen.

Blazen

Vraag

» Onvoldoende bescherm gas.

Oplossing

» Pas de gasstroom aan.
» Controleer of de gasverdeler en het gasmondstuk in goede staat zijn.

Plakken

Vraag

» De booglente niet correct.
» Las parameters niet correct.
» Wijze van lassen niet correct.
» Te lassen werkstukken zijn te groot.
» Lasboog niet regelmatig.

Oplossing

» Vergroot de afstand tussen de elektrode en het werkstuk.
» Verhoog het las voltage.
» Verhoog de las stroom.
» Verhoog het las voltage.
» Toorts schuiner houden.
» Verhoog de las stroom.
» Verhoog het las voltage.
» Verhoog de inductie waarde.

Inkartelingen

Vraag

» Las parameters niet correct.
» De booglente niet correct.
» Wijze van lassen niet correct.
» Onvoldoende bescherm gas.

Oplossing

» Verlaag de lasstroom.
» Verminder de afstand tussen de elektrode en het werkstuk.
» Verminder het voltage om te lassen.
» Verlaag de laterale oscillatiesnelheid bij het vullen.
» Voortgangsnelheid lassen verlagen.
» Gebruik voor het lassen materiaal geschikt gas.

Oxidatie

Vraag

» Onvoldoende bescherm gas.

Oplossing

» Pas de gasstroom aan.
» Controleer of de gasverdeler en het gasmondstuk in goede staat zijn.

Poreusheid

Vraag

» Smeer, lak, roest of stof op het laswerkstuk.
» Smeer, lak, roest of stof op het lasmateriaal.
» Vocht in het lasmateriaal.

Oplossing

» Maak de stukken grondig schoon alvorens ze te lassen.
» Gebruik altijd kwaliteitsproducten en materialen.
» Houdt het lasmateriaal altijd in perfecte staat.
» Gebruik altijd kwaliteitsproducten en materialen.
» Houdt het lasmateriaal altijd in perfecte staat.

- » De booglente niet correct.
- » Aanwezigheid van vocht in het gas.
- » Onvoldoende bescherm gas.
- » Het lasbad stolt te snel.
- » Verminder de afstand tussen de elektrode en het werkstuk.
- » Verminder het voltage om te lassen.
- » Gebruik altijd kwaliteitsproducten en materialen.
- » Controleer of de gastoevoer in goede staat is.
- » Pas de gasstroom aan.
- » Controleer of de gasverdeler en het gasmondstuk in goede staat zijn.
- » Voortgangsnelheid lassen verlagen.
- » Verwarm de te lassen delen voor.
- » Verhoog de las stroom.

Warmte scheuren

Vraag

- » Las parameters niet correct.
- » Smeer, lak, roest of stof op het las werkstuk.
- » Smeer, lak, roest of stof op het lasmateriaal.
- » Wijze van lassen niet correct.
- » Werkstukken met verschillende eigenschappen.

Oplossing

- » Verlaag de lasstroom.
- » Maak de stukken grondig schoon alvorens ze te lassen.
- » Gebruik altijd kwaliteitsproducten en materialen.
- » Houdt het lasmateriaal altijd in perfecte staat.
- » Volg de juiste werkmethode voor het betreffende las werk.
- » Eerst bufferlaag aanbrengen.

Koude scheuren

Vraag

- » Vocht in het lasmateriaal.
- » Speciale meetkundige vorm van het te lassen werkstuk.

Oplossing

- » Gebruik altijd kwaliteitsproducten en materialen.
- » Houdt het lasmateriaal altijd in perfecte staat.
- » Verwarm de te lassen delen voor.
- » Het werkstuk naverwarmen.
- » Volg de juiste werkmethode voor het betreffende las werk.

10. BEDIENINGSINSTRUCTIES

10.1 Lassen met constante draadtoevoer (MIG/MAG)

Inleiding

Een MIG systeem bestaat uit een gelijkstroom stroombron, een toevoerenheid, een draadspool een toorts en gas.

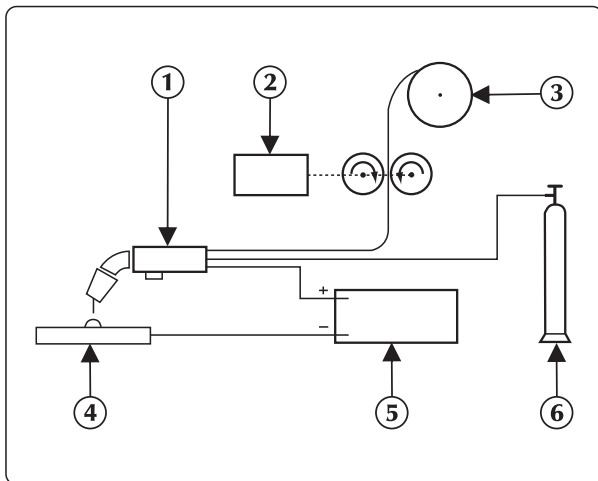

De stroom wordt op de boog overgebracht door middel van een afsmeltende elektrode (draad met positieve polariteit); in deze procedure wordt het gesmolten metaal door een boog overgebracht op het te lassen werkstuk.

De stroom wordt op de boog overgebracht via de smeltelektrode (draad met positieve polariteit);

In dit procedé wordt het gesmolten metaal via de boog op het te lassen werkstuk overgebracht.

De draadtoevoer is nodig om de gesmolten toevoegdraad tijdens het lassen aan te vullen.

1. Toorts
2. Draadtoevoer
3. Lasdraad
4. Te lassen werkstuk
5. Generator
6. Gasfles

Werkmethoden

Bij het Mig lassen onder beschermend gas zijn twee overdrachtssystemen nodig die gerangschikt kunnen worden naar de manier waarop metaal wordt overgebracht van de elektrode naar het werkstuk.

De eerste methode is "KORTSLUIT BOOGLASSEN" (Short-Arc), en hierbij komt de elektriciteit direct in aanraking met het lasbad, waardoor een kortsluiting veroorzaakt wordt waarbij de draad als zekering optreedt en de boog onderbroken wordt. Vervolgens gaat de boog weer branden en wordt de cyclus herhaald.

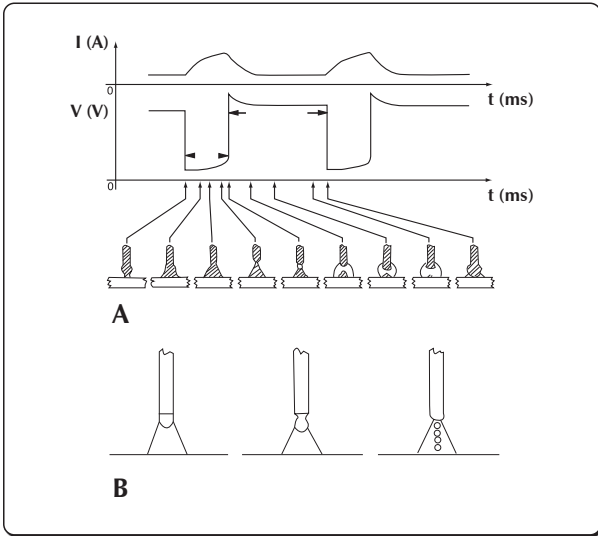

SHORT cyclus en SPRAY ARC lassen

Een andere methode voor de overdracht van de druppels vindt plaats bij het zogenaamde "SPROEI BOOGLASSEN" (Spray-Arc). Hierbij komen de druppels van de elektrode los en komen pas later in het smeltbad terecht.

Las parameters

De zichtbaarheid van de boog vermindert de noodzaak voor de lasser om de regeltabellen streng in het oog te houden omdat hij het smeltbad direct kan controleren.



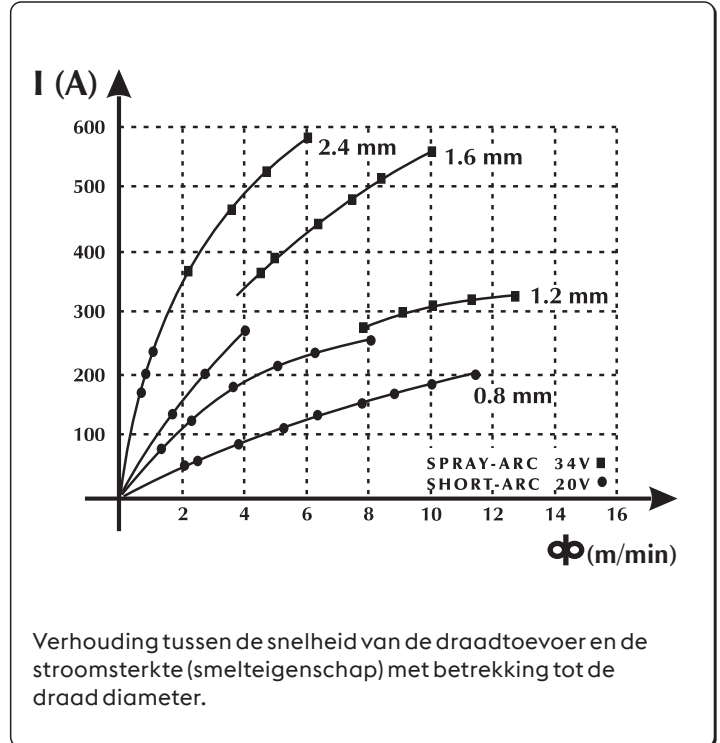
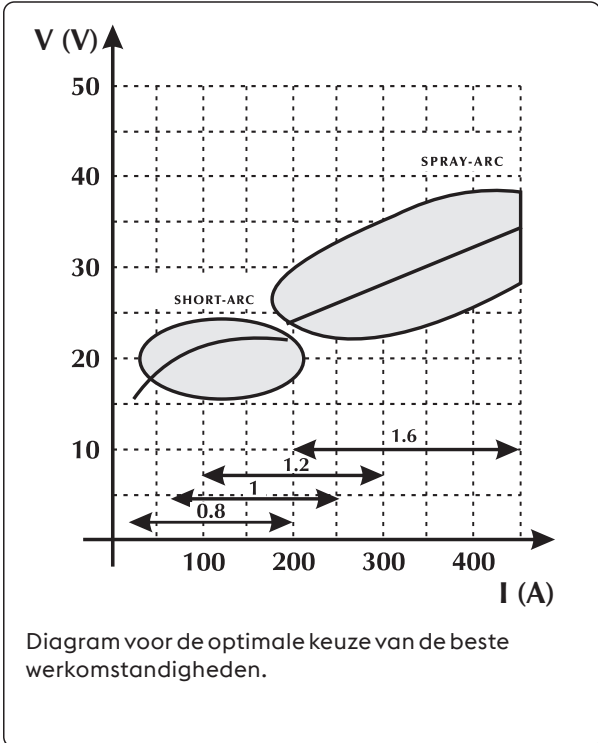

- De stroomspanning beïnvloedt direct het ontstaan van de druppel, maar de afmeting van de lasdruppel kan variëren al naar gelang het handmatig bewegen van de toorts om variabele afzettingen te krijgen met constante stroomspanning.
- De snelheid van de draadtoevoer is in verhouding met de lasstroom.

In de twee volgende afbeeldingen wordt het verband tussen de verschillende lasparameters getoond.

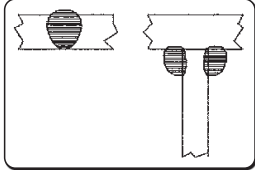
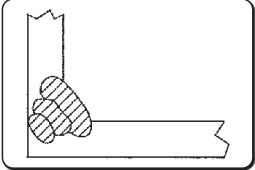
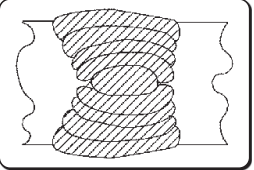

NL

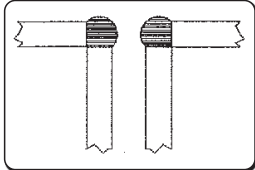
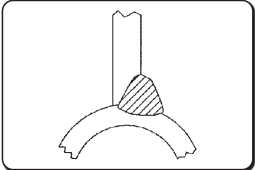
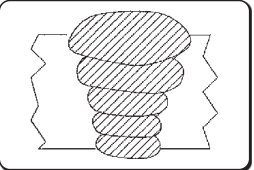
Keuze tabel voor de juiste parameters met betrekking tot de meesttypische toepassingen en de meest gebruikte draden

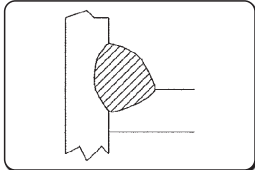
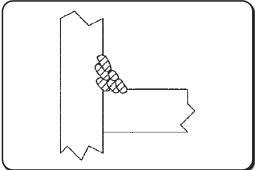
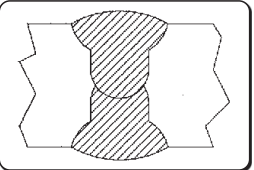
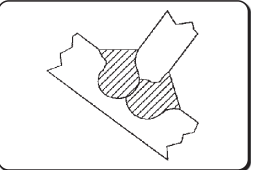
Boogspanning	Ø 0,8 mm	Ø 1,0-1,2 mm	Ø 1,6 mm	Ø 2,4 mm
16V - 22V SHORT - ARC				
	60 - 160 A Geringe penetratie voor dunne werkstukken	100 - 175 A Goede controle van de penetratie en de smelting	120 - 180 A Goede smelting horizontaal en verticaal	150 - 200 A Niet gebruikt
24V - 28V SEMI SHORT-ARC (Overgangszone)				
	150 - 250 A Automatisch Hoeklassen	200 - 300 A Automatisch lassen met hoge spanning	250 - 350 A Automatisch neer gaand lassen	300 - 400 A Niet gebruikt
30V - 45V SPRAY - ARC				
	150 - 250 A Geringe penetratie bij Afstelling op 200A	200 - 350 A Automatisch lassen met meervoudige doorgangen	300 - 500 A Goede penetratie bij neergaand Lassen	500 - 750 A Goede penetratie hoge afzetting op dikke werkstukken

NL

Unalloyed steel

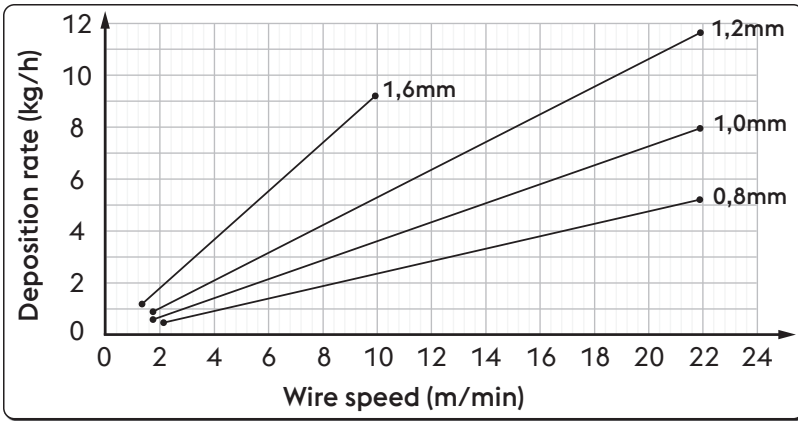

Ø	Wire speed	Deposition rate
0,8 mm	2,0 m/min	0,5 kg/h
	22,0 m/min	5,3 kg/h
1,0 mm	1,6 m/min	0,6 kg/h
	22,0 m/min	8,1 kg/h
1,2 mm	1,6 m/min	0,9 kg/h
	22,0 m/min	11,7 kg/h
1,6 mm	1,2 m/min	1,1 kg/h
	10,0 m/min	9,4 kg/h

High alloyed steel

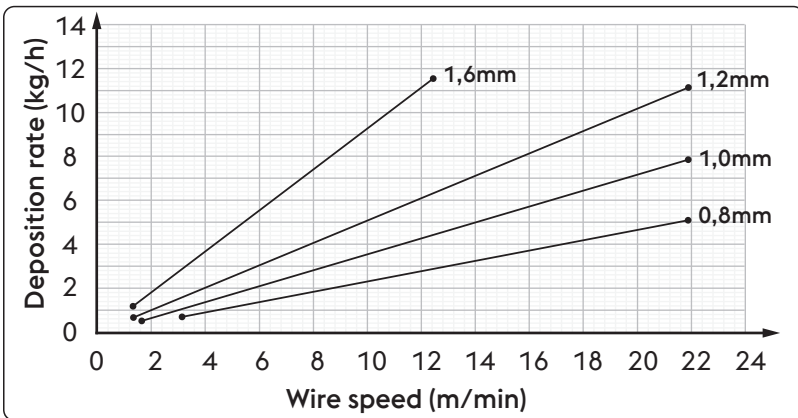

Ø	Wire speed	Deposition rate
0,8 mm	2,0 m/min	0,5 kg/h
	22,0 m/min	5,3 kg/h
1,0 mm	1,6 m/min	0,6 kg/h
	22,0 m/min	8,1 kg/h
1,2 mm	1,6 m/min	0,9 kg/h
	22,0 m/min	11,7 kg/h
1,6 mm	1,2 m/min	1,1 kg/h
	10,0 m/min	9,4 kg/h

Aluminum alloy

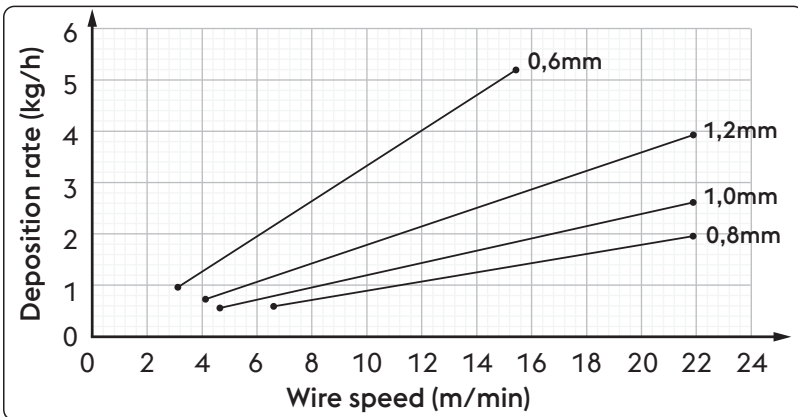

Ø	Wire speed	Deposition rate
0,8 mm	6,5 m/min	0,6 kg/h
	22,0 m/min	2,0 kg/h
1,0 mm	4,5 m/min	0,5 kg/h
	22,0 m/min	2,6 kg/h
1,2 mm	4,0 m/min	0,7 kg/h
	22,0 m/min	4,0 kg/h
1,6 mm	3,0 m/min	0,9 kg/h
	15,5 m/min	5,2 kg/h

Bruikbare gassoorten

Het MIG-MAG lassen wordt voornamelijk gekenmerkt door het type gas dat wordt gebruikt, edel gas voor het MIG lassen (Metaal Edel Gas), en actief voor het MAG lassen (Metaal Actief Gas).

- Kooldioxide (CO₂)

Het gebruik van CO₂ als beschermgas zorgt voor grote penetraties met hoge voortgangsnelheid en goede mechanische eigenschappen terwijl de kosten laag blijven. Anderzijds vormt het gebruik van dit gas aanzienlijke problemen ten aanzien van de uiteindelijke chemische samenstelling van de lasnaden omdat er gemakkelijk oxiderende elementen verloren gaan terwijl tegelijkertijd het smeltbad wordt verrijkt met koolstof.

Het lassen met zuiver CO₂ geeft ook andere problemen zoals teveel spatten en de vorming van poreusheid.

- Argon

Dit gas wordt puur gebruikt bij het lassen van lichte legeringen terwijl bij het lassen van chroomnikkel roestvrij staal de voorkeur gegeven wordt aan het gebruik van argon met toevoeging van zuurstof en CO₂ in het percentage 2% omdat dit bijdraagt aan de stabiliteit van de boog en de vorming van druppels bevordert.

- Helium

Dit gas wordt gebruikt als alternatief voor argon en zorgt voor grotere penetratie (op dik materiaal) en grotere voortgangsnelheid.

- Argon-Helium mengsel

Zorgt voor een meer stabiele boog ten opzichte van zuiver helium en een grotere penetratie en hogere snelheid ten opzichte van argon.

- Argon-CO₂ en Argon-CO₂-Zuurstif mengsel

Deze mengsels worden gebruikt bij het lassen van ijzerhoudende materialen vooral bij Short-Arc omdat ze de warmte inbreng verbeteren.

Ze kunnen ook worden gebruikt bij Spray-Arc.

Gewoonlijk bevat het mengsel een percentage CO₂ dat varieert van 8% tot 20% en O₂ van ongeveer 5%.

Raadpleeg het de handleiding van het systeem.

Unalloyed steel / High alloyed steel		Aluminum alloy	
Stroomgamma	Gasstroom	Stroomgamma	Gasstroom
3-50 A	10-12 l/min	3-50 A	10-12 l/min
30-100 A	10-14 l/min	30-100 A	10-15 l/min
75-150 A	12-16 l/min	75-150 A	12-18 l/min
150-250 A	14-18 l/min	150-250 A	14-22 l/min
250-400 A	16-20 l/min	250-400 A	16-25 l/min
400-500 A	18-22 l/min	400-500 A	18-30 l/min

NL

11. TECHNISCHE KENMERKEN

Kenmerken draadtoevoersysteem WF NX 430 SteelDrive		U.M.
Type reductiemotor	SL4R-4T	
Vermogen motorreductor	120	W
Geen rollen	4	
Diameter lasdraad / Standaard rol	1.0-1.2	mm
Diameter bruikbaar draad / Buigzame rollen	Snelheid van de draadtoevoer 0.8-1.6 aluminium lasdraad 1.2-2.4 gevulde lasdraad	mm/Materiaal
Gasontluchtingsknop	ja	
Draadtoevoerknop	ja	
Drukknop draadterugslag	nee	
Draadsnelheid	25 Ø 0.8 - 1.0	m/min
Synergische programma's	ja	
Externe apparatuur	ja (facultatief)	
Contactpunt voor Push-Pull toorts	ja (facultatief)	
Diameter draadspoel	200/300	mm
Diameter voorwielen	63/125 (optional)	mm
Diameter achterwielen	63/125 (optional)	mm
Elektrische kenmerken WF NX 430 SteelDrive		U.M.
Netspanning U1	48	Vdc
Can-bus aansluiting	DIGITAAL	
Maximaal opgenomen stroom I1max	4.5	A
Gebruiksfactor WF NX 430 SteelDrive		U.M.
Gebruiksfactor (40°C)		
(X=50%)	500	A
(X=60%)	470	A
(X=100%)	420	A
Gebruiksfactor (25°C)		
(X=80%)	500	A
(X=100%)	470	A
Fysieke eigenschappen WF NX 430 SteelDrive		U.M.
IP Beveiligingsgraad	IP23S	
Afmetingen (lxdxh)	640x250x460	mm
Gewicht	19.0	Kg
Constructienormen	EN IEC 60974-5:2019 EN 60974-10/A1:2015	

12. GEGEVENSPLAAT

VOESTALPINE BÖHLER WELDING SELCO S.R.L. Via Palladio, 19 - ONARA (PADOVA) - ITALY			
WF NX 430		N°	
EN 60974-5:2019 IEC 60974-10/A1:2015 Class A			
	X (40°C)	60%	100%
	I₂	500A	400A
	U₁ 48V	I_{1max} 4.5A	
IP 23 S		UK CA CE EAC	
MADE IN ITALY			

13. BETEKENIS GEGEVENSPLAATJE

1		2	
3		4	
5			
	6	6A	6B
	7	7A	7B
8	9	10	
11		UK CA CE EAC	
MADE IN ITALY			

- 1 Fabrieksmerk
- 2 Naam en adres van de fabrikant
- 3 Model van de apparatuur
- 4 Serienummer
- X **XX**XXXXXXXXXXXXX Bouwjaar
- 5 Verwijzing naar de constructienormen
- 6 Symbool van de intermitterende cyclus
- 7 Symbool van de nominale lasstroom
- 6A Waarden van de intermitterende cyclus
- 6B Waarden van de intermitterende cyclus
- 7A Waarden van de nominale lasstroom
- 7B Waarden van de nominale lasstroom
- 8 Symbool voor de voeding
- 9 Nominale voedingsspanning
- 10 Nominale maximale voedingsstroom
- 11 Beschermingsgraad

CE EU-Conformiteitsverklaring
 EAC EAC-Conformiteitsverklaring
 UKCA UKCA-Conformiteitsverklaring

NL

EU-FÖRSÄKRAN OM ÖVERENSSTÄMMELSE

Byggaren

voestalpine Böhler Welding Selco S.r.l. - Via Palladio, 19 - 35019 Onara di Tombolo (PD) - ITALY
Tel. +39 049 9413/111 - Fax +39 049 9413/311 - www.voestalpine.com/welding

förklarar under ensam ansvar att följande produkt:

WF NX 430 STEELDRIVE

71.01.083

överensstämmer med direktiven EU:

2014/35/EU LOW VOLTAGE DIRECTIVE

2014/30/EU EMC DIRECTIVE

2011/65/EU RoHS DIRECTIVE

och att följande harmoniserade standarder har tillämpats:

EN IEC 60974-5:2019

WIRE FEEDERS

EN 60974-10/A1:2015

ELECTROMAGNETIC COMPATIBILITY REQUIREMENTS

Dokumentationen som intygar överensstämmelse med direktiven kommer att finnas tillgänglig för inspektioner hos ovannämnda tillverkare.

Ingrepp eller modifieringar utan tillstånd av Böhler Welding Selco S.r.l. medför att denna försäkran inte längre är giltig.

Onara di Tombolo, 03/07/2023

voestalpine Böhler Welding Selco s.r.l.

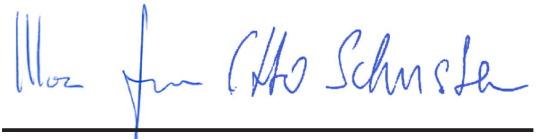

Mirco Frasson

Otto Schuster

Managing Directors

SV

INNEHÅLLSFÖRTECKNING

1. VARNING	271
1.1 Driftsmiljö	271
1.2 Personligt skydd och skydd för tredje man.....	271
1.3 Skydd mot rök och gas	272
1.4 Skydd mot bränder/explosioner.....	272
1.5 Försiktighetsåtgärder vid användning av gasbehållare	273
1.6 Skydd mot elektriska urladdningar	273
1.7 Elektromagnetiska fält och störningar	273
1.8 IP-skyddsgrad	274
1.9 Jäätmekåitlus	274
2. INSTALLATION	274
2.1 Lyftning, transport och lossning	274
2.2 Aggregatets placering.....	274
2.3 Inkoppling.....	275
2.4 Igångsättning	275
3. BESKRIVNING AV AGGREGATET	276
3.1 Bakre kontrollpanel.....	276
3.2 Kopplingstavla	277
3.3 Främre kontrollpanel	277
4. ANVÄNDNING AV UTRUSTNINGEN	278
4.1 Igångsättningskärmen	278
4.2 Testskärm	278
4.3 Huvudskärmen.....	279
5. SETUP	282
5.1 Set-up och ställa in parametrar	282
5.2 Särskilda procedurer för användning av parametrar	291
6. TILLBEHÖR	295
7. UNDERHÅLL	295
7.1 Periodiska kontroller av generatoren.....	295
7.2 Odpowiedzialność	295
8. LARMKODER	296
9. FELSÖKNING OCH TIPS	298
10. ARBETSINSTRUKTIONER	300
10.1 Svetsning med kontinuerlig tråd (MIG/MAG).....	300
11. TEKNISKA DATA	304
12. MÄRKPLÅT	305
13. MÄRKPLÅTENS INNEBÖRD	305
14. KOPPLINGSSHEMA	459
15. KONTAKTDON	460
16. RESERVDLSLISTA	461
17. INSTALLATION KIT/TILLBEHÖR	464

SYMBOLER



Överhängande fara som orsakar allvarlig skada och riskbeteende som kan orsaka allvarlig skada.



Beteende som kan orsaka lättare personskador eller saksador.



Tekniska anmärkningar som underlättar arbetet.

1. VARNING



Läs den här instruktionsboken ordentligt och se till att du har förstått anvisningarna innan du börjar arbeta med maskinen.

Modifiera inte maskinen och utför inget underhåll som inte anges här. Tillverkaren påtar sig inget ansvar för person- eller sakskador som uppkommer till följd av att denna instruktionsbok inte har lästs uppmärksam eller att instruktionerna i den inte har följts.

Förvara alltid bruksanvisningen på den plats där apparaten används. Följ utöver bruksanvisningen även de allmänna föreskrifterna och gällande lokala bestämmelser om förebyggande av olyckor och miljöskydd.



Alla personer som ansvarar för driftsättningen, användningen, underhållet och reparationen av apparaten ska

- ha rätt kvalifikation
- ha nödvändiga svetskunskaper
- läsa hela bruksanvisningen och följa den noggrant

Rådfråga fackman om du är tveksam till hur aggregatet ska användas eller om du får problem.

1.1 Driftsmiljö



Aggregaten får endast användas för de ändamål som de har konstruerats för, på de sätt och de områden som anges på märkplåten och/eller i denna instruktionsbok, i enlighet med nationella och internationella säkerhetsnormer. Användning som avviker från vad tillverkaren uttryckligen har föreskrivit ska betraktas som helt olämplig och farlig. Tillverkaren påtar sig inget ansvar i sådana fall.



Denna apparat får endast användas för professionellt bruk i industrimiljö. Tillverkaren påtar sig inget ansvar för skador som orsakas av att aggregatet används i hemmiljö.



Aggregatet ska användas i omgivningar med temperatur på mellan -10 °C och +40 °C (mellan +14 °F och +104 °F).

Aggregatet ska transporteras och förvaras i omgivningar med temperatur på mellan -25 °C och +55 °C (mellan -13 °F och +131 °F).

Miljön ska vara fri från damm, syror, gaser och andra frätande ämnen.

Den relativa luftfuktigheten ska vara högst 50 % vid 40 °C (104 °F).

Den relativa luftfuktigheten ska vara högst 90 % vid 20 °C (68 °F).

Aggregatet får användas på en höjd av högst 2000 m över havet (6500 fot).



Använd inte maskinen till att avfrosta rör.

Använd inte aggregatet för att ladda batterier och/eller ackumulatorer.

Använd inte aggregatet för att starta motorer.

1.2 Personligt skydd och skydd för tredje man



Svetsning ger upphov till skadlig strålning, buller, värme- och gasutveckling. Sätt upp en brandhärdig skiljevägg för att skydda svets från strålar, gnistor och het slagg. Varna eventuella utomstående för att de inte ska stirra på svetstället och uppmana dem att skydda sig emot strålning och het metall.



Använd skyddskläder samt svetshjälm för att skydda huden mot strålning. Använd arbetskläder som täcker hela kroppen och är:

- hela och i gott skick
- brandhärdiga
- isolerande och torra
- åtsittande och utan slag



Använd alltid skor som uppfyller kraven i regler och bestämmelser och är motståndskraftiga och vattenisolerande.

Använd alltid handskar som uppfyller kraven i regler och bestämmelser och som ger elektrisk och termisk isolering.



Använd masker med sidoskydd för ansiktet och lämpligt skyddsfilter (minst NR10) för ögonen.



Använd alltid skyddsglasögon med sidoskydd, särskilt vid manuell eller mekanisk slaggborttagning.



Använd inte kontaktlinser!



Använd hörselskydd om svetsningen ger upphov till skadligt buller. Avgränsa arbetsområdet om bullernivån överskrider lagens gränser och tillse att de personer som kommer in i området har hörselskydd.



Håll alltid sidopanelerna stängda under svetsningen. Aggregatet får inte modifieras på något sätt. Undvik kontakt mellan händer, hår, plagg, redskap och dylikt och rörliga delar som: fläktar, drev, valsar och axlar, trådullar. Arbeta inte på dreven när trådmatningsenheten är i drift. Det är oerhört farligt att koppla bort skydden på trådmatningsenheterna. Tillverkaren påtar sig inget ansvar för person- eller saskador om detta görs.



Håll huvudet på avstånd från MIG-/MAG-brännaren när du sätter i och matar fram tråden. Den tråd som matas ut kan orsaka allvarliga skador på händer, ansikte och ögon.



Undvik att röra arbetsstycken som just har svetsats, eftersom den höga värmen kan medföra allvarliga brännskador. Vidtag alla ovan beskrivna försiktighetsåtgärder också vid bearbetning efter svetsningen, eftersom slag kan lossna från arbetsstycken som håller på att svalna.



Kontrollera att brännaren har svalnat innan du utför arbeten eller underhåll på den.



Kontrollera att kylvatten är avstängd innan du kopplar loss matarslangen och returslangen för kylvätskan. Den heta vätskan kan ge allvarliga brännskador.



Ha första hjälpen-utrustning tillgänglig. Banalisera inte brännskador eller sår.



Säkra det område du ansvarar för innan du lämnar arbetsplatsen, för att motverka risken för person- och saskador.

1.3 Skydd mot rök och gas



Rök, gas och damm som uppstår under svetsningen kan vara skadligt för hälsan. Rök som uppstår under svetsningen kan under vissa omständigheter leda till cancer eller skador på gravida kvinnors foster.

- Håll huvudet på avstånd från svetsgaserna och svetsröken.
- Tillse att arbetsområdet har en tillräckligt god naturlig eller forcerad ventilation.
- Använd ansiktsmask med andningsapparat om ventilationen är otillräcklig.
- Vid svetsning i trånga utrymmen rekommenderar vi att operatören övervakas av en kollega som befinner sig utanför utrymmet i fråga.
- Använd inte syre för ventilationen.
- Kontrollera med jämna mellanrum att insugningen är effektiv genom att jämföra utsläppen av skadliga gaser med de värden som säkerhetsbestämmelserna tillåter.
- Hur mycket rök som produceras och hur farlig denna är beror på det använda grundmaterialet, svetsmaterialet och eventuella ämnen som används för att rengöra eller avfetta de arbetsstycken som ska svetsas. Följ tillverkarens anvisningar och tekniska instruktioner noggrant.
- Svetsa inte i närheten av platser där avfettning eller lackering pågår.
- Placera gasbehållarna i öppna utrymmen eller i utrymmen med god luftcirkulation.

1.4 Skydd mot bränder/explosioner



Svetsningen kan ge upphov till bränder och/eller explosioner.

- Avlägsna eldfarligt och brännbart material och föremål från arbetsområdet och dess omgivningar.
- Inget brännbart material får finnas inom 11 meter (35 fot) från svetsstället om det inte skyddas ordentligt.
- Gnistor och glödande partiklar kan lätt komma ut i omgivningen också genom små öppningar. Var mycket noggrann med att sätta föremål och personer i säkerhet.
- Svetsa inte på eller i närheten av tryckutsatta behållare.
- Svetsa inte i stängda behållare eller rör. Var mycket försiktig vid svetsning av behållare eller tuber, även om dessa har öppnats, tömts och rengjorts noggrant. Rester av gas, bränsle, olja eller liknande kan medföra explosioner.
- Svetsa inte i atmosfär som innehåller damm, gas eller explosiva ångor.
- Kontrollera att den spänningsförande kretsen inte av misstag kan komma i kontakt med delar som är anslutna till jordkretsen när svetsningen är avslutad.
- Anordna med brandsläckningsutrustning eller ett brandskyddssystem i närheten av arbetsområdet.

1.5 Försiktighetsåtgärder vid användning av gasbehållare



Behållare med skyddsgas innehåller gas under tryck och kan explodera om inte minimivillkoren för transport, förvaring och användning är uppfyllda.

- Behållarna ska fästas i vertikalt läge i väggar eller annat på lämpligt sätt för att undvika fall och mekaniska sammanstötningar.
- Skruva på skyddshatten på ventilen under transport, idrifttagning och efter avslutad svetsning.
- Undvik att utsätta behållarna för direkt solljus och stora temperaturvariationer. Utsätt inte behållarna för mycket låga eller höga temperaturer.
- Undvik att behållarna kommer i kontakt med öppna lågor, elektriska bågar, brännare eller elektrodhållare och gnistor från svetsningen.
- Håll behållarna på avstånd från svetskretsarna och strömkretsar i allmänhet.
- Håll huvudet på avstånd från gasutloppet när du öppnar ventilen på behållaren.
- Stäng alltid ventilen på behållaren efter avslutad svetsning.
- Svetsa aldrig på tryckutsatta gasbehållare.
- Anslut aldrig en tryckluftsbehållare direkt till maskinens tryckregulator! Trycket kan överstiga tryckregulatorns kapacitet och få denna att explodera!

1.6 Skydd mot elektriska urladdningar



Elektriska urladdningar kan vara livsfarliga.

- Undvik att vidröra delar som normalt är spänningsförande inuti eller utanför svetsstaten när det är strömförsörjt (brännare, gripklor, jordledare, elektroder, trådar, valsar och rullar är elektriskt anslutna till svetskretsen).
- Se till att aggregatet och operatören isoleras elektriskt genom att använda torra plan och underreden som är tillfredsställande isolerade från nollpotentialen och jordpotentialen.
- Se till att aggregatet ansluts korrekt till en stickpropp och ett jordat elnät.
- Vidrör inte två brännare eller två elektrodhållare samtidigt.
- Avbryt omedelbart svetsningen om du får en elektrisk stöt.

1.7 Elektromagnetiska fält och störningar



När strömmen passerar genom ledningarna i och utanför aggregatet skapas ett elektromagnetiskt fält i svetskablarnas och aggregatets omedelbara närhet.

- Elektromagnetiska fält kan ha (hittills okända) hälsoeffekter för den som exponeras långvarigt för dem.
- Elektromagnetiska fält kan interferera med annan utrustning som pacemakar och hörapparater.



Bärare av livsuppehållande elektronisk apparatur (pacemaker) måste konsultera läkare innan de närmar sig platser där bågsvetsning.

1.7.1 EMC-klassificeras i enlighet med: EN 60974-10/A1:2015.

Klass B

Utrustning i klass B följer kraven på elektromagnetisk kompatibilitet för industri- och boendemiljöer, inklusive för bostadsområden där el levereras via det allmänna lågspänningsnätet.

Klass A

Utrustning i klass A är inte avsedd för bruk i bostadsområden där elen levereras via det allmänna lågspänningsnätet. Det kan vara svårt att garantera elektromagnetisk kompatibilitet för utrustning i klass A på sådana platser, på grund av såväl ledningsbundna som strålade störningar.

För mer information, se kapitlet: MÄRKPLÅT eller TEKNISKA DATA.

1.7.2 Installation, drift och omgivningsbedömning

Denna apparat är konstruerad i överensstämmelse med anvisningarna i den harmoniserade standarden EN 60974-10/A1:2015 och tillhör Klass A. Denna apparat får endast användas för professionellt bruk i industrimiljö. Tillverkaren påtar sig inget ansvar för skador som orsakas av att aggregatet används i hemmiljö.



Användaren ska vara expert på området och är som sådan ansvarig för att apparaten installeras och används enligt tillverkarens anvisningar. Vid eventuella elektromagnetiska störningar ska användaren lösa problemet med hjälp av tillverkarens tekniska service.



De elektromagnetiska störningarna måste alltid minskas så mycket att de inte medför besvär.



Innan apparaten installeras ska användaren bedöma vilka eventuella elektromagnetiska problem som kan uppstå i det omgivande området och särskilt hälsotillståndet hos personalen i området, till exempel de som använder pacemakar eller hörapparater.

SV

1.7.3 Försiktighetsåtgärder avseende kablar

Följ nedanstående anvisningar för att minimera effekterna av de elektromagnetiska fälten:

- Rulla ihop jordledaren och elkabeln och fäst dem när så är möjligt.
- Undvik att rulla ihop kablarna i närheten av kroppen.
- Undvik att vistas mellan jordledaren och elkabeln (hålla båda på samma sida).
- Ledningarna ska hållas så korta som möjligt och ska placeras nära varandra och löpa på eller i närheten av golvnivån.
- Placera aggregatet på avstånd från svetszonen.
- Placera kablarna på avstånd från eventuella andra kablar.

1.7.4 Ekvipotentialförbindning

Man bör överväga att jorda alla metalldelar i svetsanläggningen och i dess närhet. Följ nationella bestämmelser om ekvipotentialförbindning.

1.7.5 Jordning av arbetsstycket

Om arbetsstycket av elsäkerhetsskäl eller beroende på dess storlek eller placering inte är jordat kan en jordledning mellan arbetsstycket och jorden minska emissionerna. Man måste se till att jordningen av arbetsstycket inte ökar risken att användarna skadas eller skadar andra elektriska apparater. Följ nationella bestämmelser om jordning.

1.7.6 Skärmning

Selektiv skärmning av andra kablar och apparater i omgivningarna kan minska störningsproblemen. För speciella applikationer kan man överväga att skärma hela svetsanläggningen.

1.8 IP-skyddsgrad



IP23S

- Höljet förhindrar att man kommer åt farliga delar med fingrarna och skyddar mot fasta främmande föremål med en diameter på 12,5 mm eller mer.
- Höljet skyddar mot regn i 60° vinkel mot vertikalled.
- Höljet är skyddat mot skador till följd av inträngande vatten när utrustningens rörliga delar inte är i rörelse.

1.9 Jååtmekååtlus



Bortskaffa inte elutrustningen tillsammans med vanligt avfall!

I enlighet med direktiv 2012/19/EU om avfall som utgörs av eller innehåller elektrisk och elektronisk utrustning och bestämmelserna om dess införlivande med nationell lagstiftning ska uttjänad elutrustning samlas in separat och lämnas till en insamlings- och återvinningscentral. Utrustningens ägare ska vända sig till kommunen för att identifiera de auktoriserade insamlingscentralerna. Tillämpningen av EU-direktivet kommer att bidra till att förbättra miljön och människors hälsa.

» Besök webbplatsen för mer information.

2. INSTALLATION



Endast personal med specialkunskaper och tillstånd från tillverkaren får installera kylvanheten.

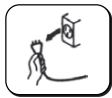

Se till att generatorn är ansluten till elnätet innan installationen görs.

2.1 Lyftning, transport och lossning

- Aggregatet har ett handtag så att du kan bära det.
- Aggregatet har inga särskilda lyftanordningar.
- Lyft det med gaffeltruck och var ytterst försiktig under förflyttningen så att inte generatorn faller.



Underskatta inte aggregatets vikt, se tekniska data.

Förflytta eller stoppa inte lasten ovanför människor eller föremål.

Låt inte aggregatet eller en enskild enhet falla eller ställas ned med en kraftig stöt.

2.2 Aggregatets placering



Tillämpa följande kriterier:

- Kommandon och kopplingar ska vara lättillgängliga.
- Placera inte utrustningen i trånga utrymmen.
- Placera inte aggregatet på ett plan som lutar mer än 10° i relation till horisontalplanet.
- Placera aggregatet på torr, ren plats med god ventilation.
- Skydda aggregatet mot regn och direkt solljus.

2.3 Inkoppling



Flyttbara enheter strömförsörjs uteslutande med lågspänning.

2.4 Igångsättning

2.4.1 Anslutning för MIG-/MAG-svetsning

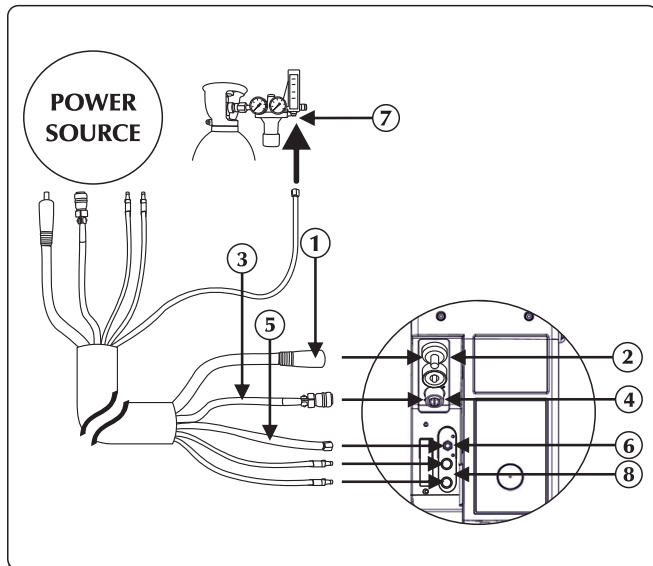

- ① Elkabel
- ② Positivt uttag (+)
- ③ Signalkabel
- ④ Ingång för signalkabel
- ⑤ Gasrör
- ⑥ Koppling/anslutning gas
- ⑦ Koppling för gastillförsel
- ⑧ Kylvätskeanslutning

- ▶ Anslut elkabeln i ledningsknippet till uttaget. Sätt i stickproppen och vrid medsols så att den fästs ordentligt.
- ▶ Anslut signalkabeln i ledningsknippet till kontaktdonet. För in kontakten och vrid överfallsmuttern medurs för att låsa kontaktdelarna till varandra.
- ▶ Anslut gasslangen i ledningsknippet till gasbehållarens tryckregulator eller till gasuttaget. Ställ in gasflödet på mellan 10 och 30 l/min.
- ▶ Anslut matarslangen för kylvätska i ledningsknippet (blå) till kopplingen (blå - symbol).
- ▶ Anslut returslangen för kylvätska i ledningsknippet (röd) till kopplingen (röd - symbol).
- ▶ Anslut signalledningen till CAN-bussen för styrning av externa enheter (t.ex. RC och RI) till den avsedda kontakten.

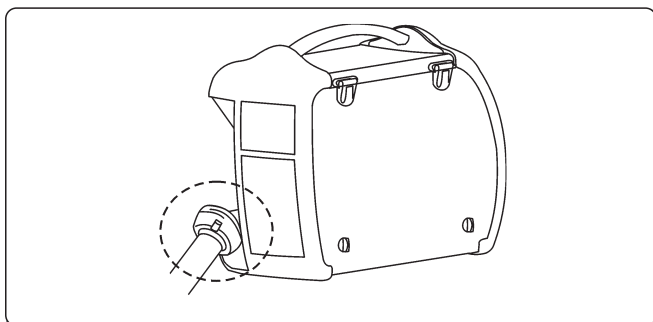

Se avsnittet "Installation tillbehör".

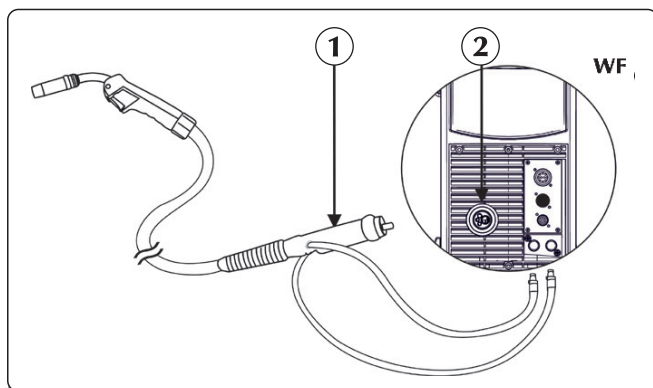

- ① Brännaruttag
- ② Kontaktdon

- ▶ Anslut returslangen för kylvätska från brännaren (röd) till kopplingen (röd - symbol).
- ▶ Anslut matarslangen för kylvätska till brännaren (blå) till kopplingen (blå - symbol).
- ▶ Anslut MIG/MAG-brännaren till uttaget och var noga med att skruva åt låsringen helt.

SV

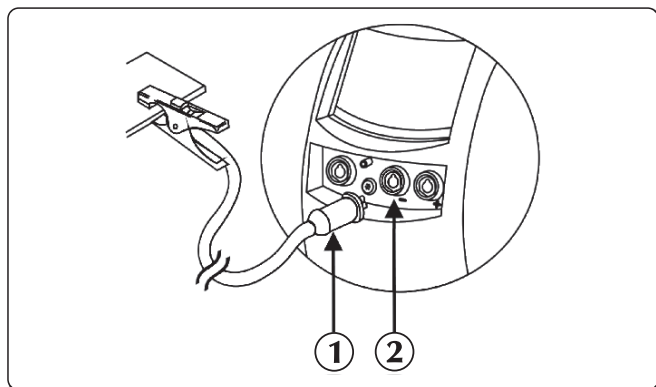

- ① Jordklämkontakt
- ② Negativt uttag (-)

► Anslut jordklämman till kraftaggregatets negativa uttag (-). Sätt i stickproppen och vrid medsols så att den fästs ordentligt.

Motorutrymme

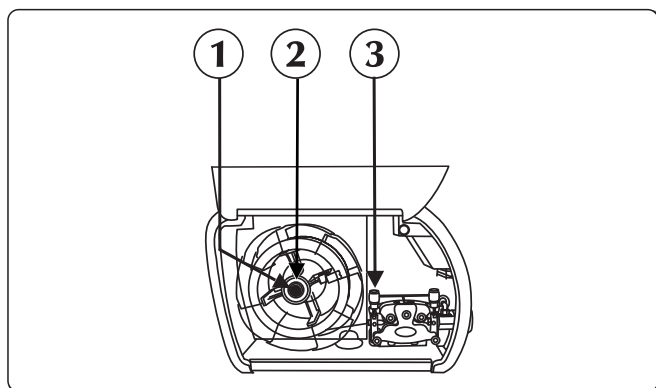

- ① Låsringen
- ② Friktionsskruven
- ③ Stödet för kuggväxelmotor trådmatare

- Öppna huven på högra sidan.
- Kontrollera att valsspåret överensstämmer med önskad tråddiameter.
- Skruva loss låsringen från trådrullshållaren och för in trådrullen.
- För också in hållarens metallstift på plats, sätt i rullen, sätt tillbaka låsringen på plats och dra åt friktionsskruven.
- Lossa stödet för kuggväxelmotorns trådmatare och för in trådänden i trådförarbussningen via valsens till brännaruttaget. Lås stödet i position och kontrollera att tråden är införd i valsspåret.
- Tryck på frammatningsknappen för att föra in tråden i brännaren.
- Ställ in gasflödet på mellan 10 och 30 l/min.

3. BESKRIVNING AV AGGREGATET

3.1 Bakre kontrollpanel

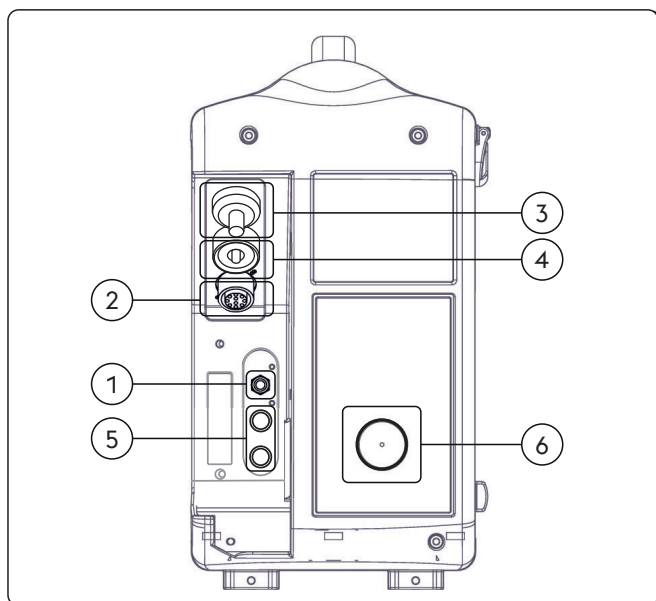

- ① Anslutning för gasledning
- ② Ingång för signalkabel (CAN-BUS) (ledningsknippe)
- ③ Ingång för elkabel (ledningsknippe)
- ④ Positivt uttag (+)
- ⑤ Kylvätskans inlopp/utlopp
- ⑥ Ingång för tråden

SV



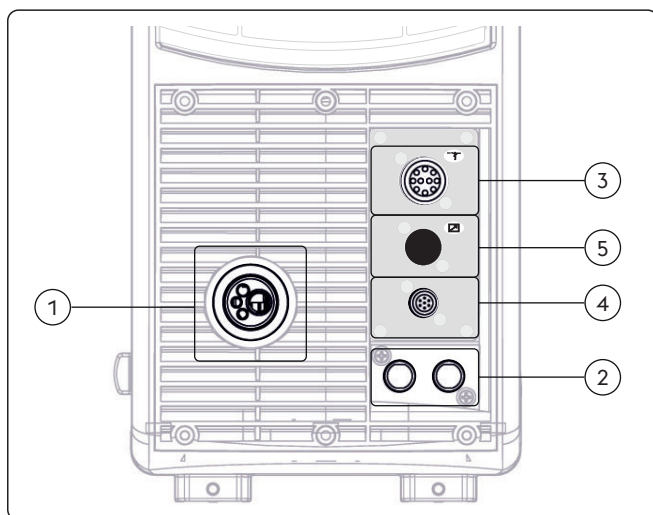

3.2 Kopplingstavla



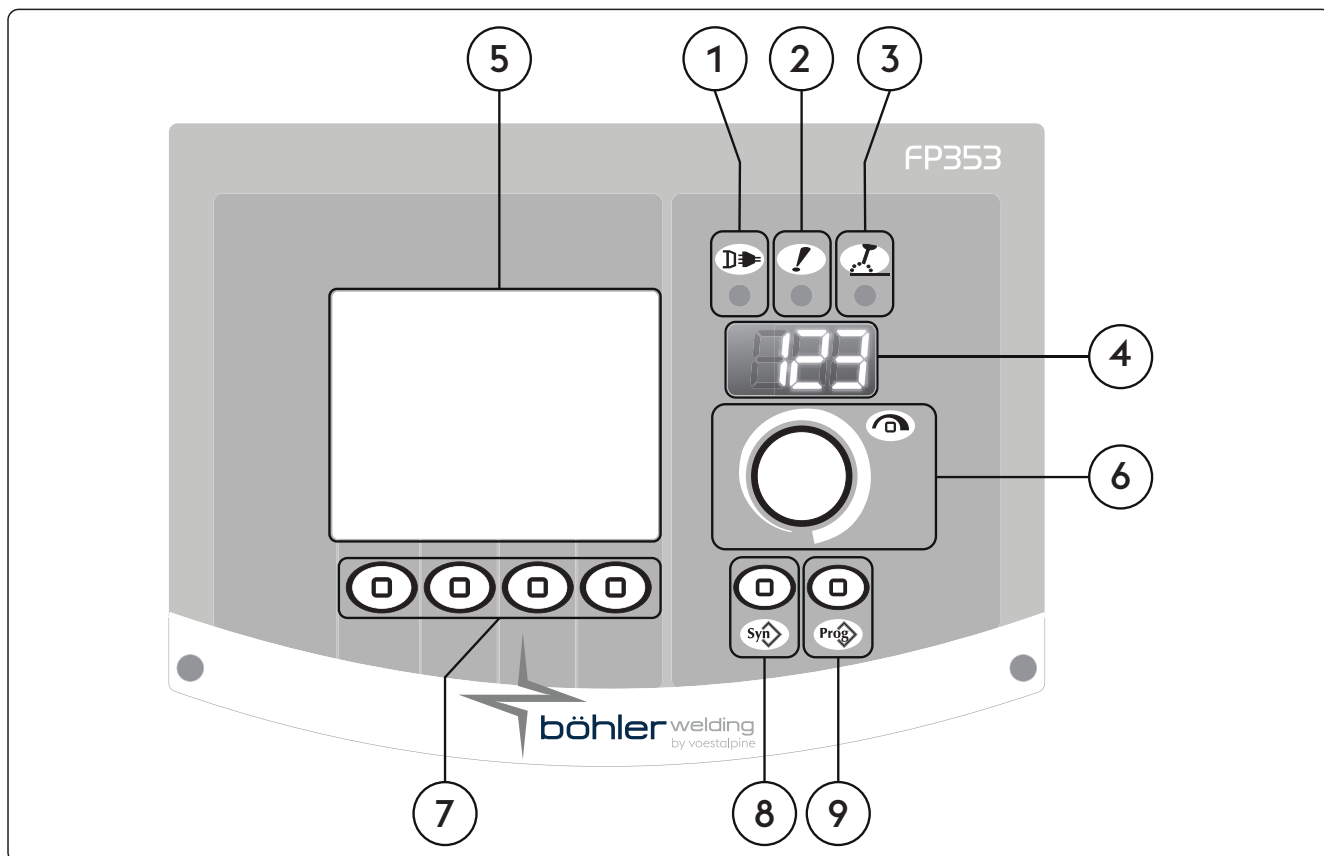



- ① **Brännaruttag**
För anslutning av MIG/MAG-brännaren.
- ② **Kylvätskeanslutning**
- ③ **Ingång för signalkabel (Push-Pull)**
- ④ **Ingång för signalkabel (brännare)**
Anslutning av brännare
- ⑤ **Uttag för signalkabel (RC)**

3.3 Främre kontrollpanel



- ①  **Ström-LED**
Visar att utrustningen är ansluten till elnätet och påslagen.
- ②  **Allmänt larm-LED**
Visar när skyddsutrustning som temperaturkyddet aktiveras.
- ③  **Aktiv effekt-LED**
Visar att det finns ström i utrustningens utgångar.
- ④  **Display med 7 segment**
Här visas de allmänna svetsparametrarna under start, inställningar, ström- och spänningsvärden vid svetsning samt larmkoder.

SV

- 5**  **LCD-display**
 Här visas de allmänna svetsparametrarna under start, inställningar, ström- och spänningsvärden vid svetsning samt larmkoder.
 Alla aktiviteter kan visas utan fördröjning.
- 6**  **Huvudjusteringshandtag**
 Gör det möjligt att konfigurera, välja och ställa in svetsparametrar.
- 7**  **Funktionsknappar**
 Medger val av olika systemfunktioner:
 - Svetsprocess
 - Svetsmetoder
 - Strömpulsning
 - Grafiskt gränssnitt
- 8**  **Svetsprogram knapp**
 Medger val av förinställt svetsprogram genom att välja några enkla inställningar:
 - Typ av tråd
 - Typ av gas
 - Wtråddiameter
- 9**  **Knapp för jobb**

4. ANVÄNDNING AV UTRUSTNINGEN



4.1 Igångsättningskärmen

När generatoren startas genomför den ett antal kontroller för att garantera att systemet fungerar korrekt, inklusive alla anslutna enheter. I samma skede genomförs också gastestet för att kontrollera att systemet för gastillförsel fungerar korrekt.

4.2 Testskärm

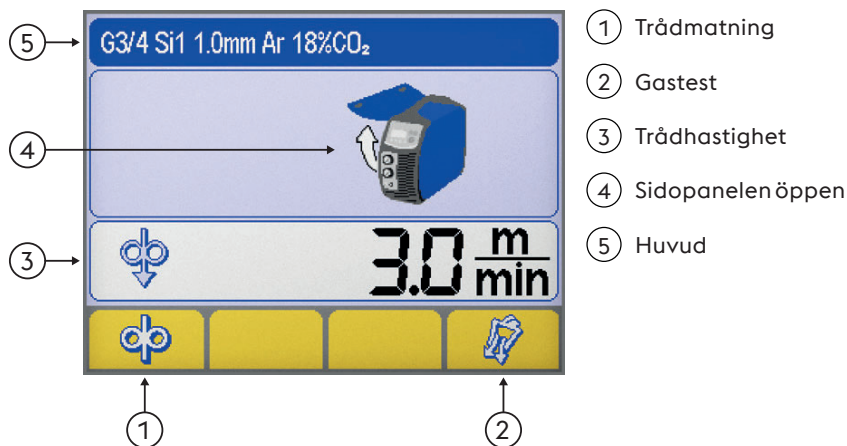
När sidopanelen (spolutrymmet) är öppet spärras svetsfunktionerna.
 Testskärmen visas på LCD-displayen.



-  **Trådmatning**
 Gör det möjligt att mata tråden manuellt utan gasflöde och utan ström till tråden.
 Gör att man kan föra in tråden i brännarhöljet under svetsningens förberedelsefaser.
-  **Gastest**
 Gör att man kan avlägsna föroreningar från gaskretsen och ställa in preliminärtryck och justera tryckluftens tryck utan att slå på strömmen.

-  **Tråd hastighet**
 Medger inställning av trådmatningshastigheten (under lastningssteget).

Minimum	Maximum	Standard
0.5 m/min	22.0 m/min	3.0 m/min



Sidopanelen öppen



Huvud

Visar vissa viktiga uppgifter i relation till den valda processen.

4.3 Huvudskärmen

Används för att styra systemet och svetsprocessen. De viktigaste inställningarna visas.

4.4 Huvudskärmbild för MIG/MAG-process

Grundskärmbild

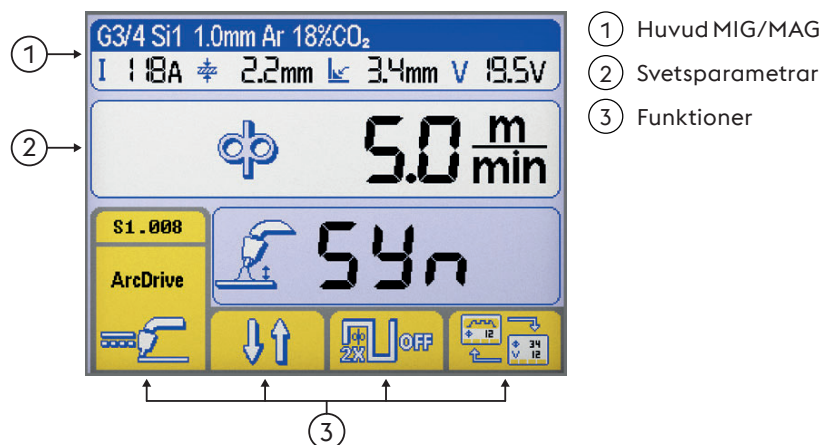

Grafisk skärmbild

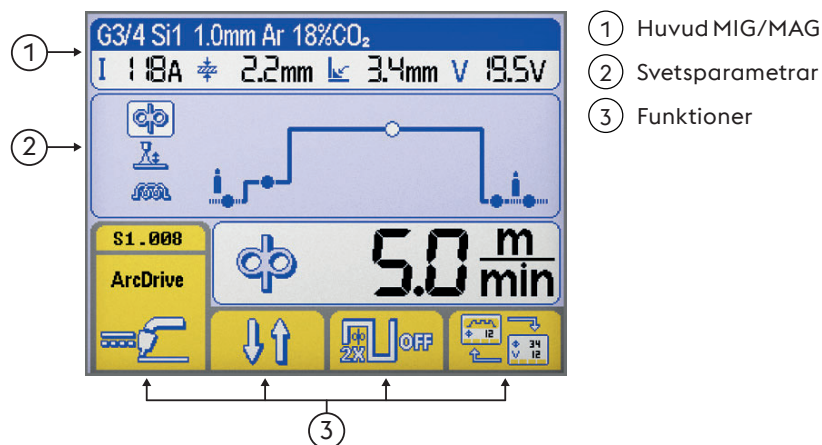

Huvud MIG/MAG

Visar vissa viktiga uppgifter i relation till den valda processen.

G3/4 Si1 1.0mm Ar 18%CO₂

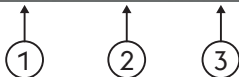

Vald synergikurva

- ① Typ av svetstråd
- ② Wtråddiameter
- ③ Typ av gas

I 118A 2.2mm 3.4mm V 19.5V



Svetsparametrar

- ① Svetsström
- ② Ämnestjocklek
- ③ Hörfog "a"
- ④ Arbetsspänning

Svetsparametrar (Grundskärmbild)

► Välj önskad parameter genom att trycka på kodningsvredet.

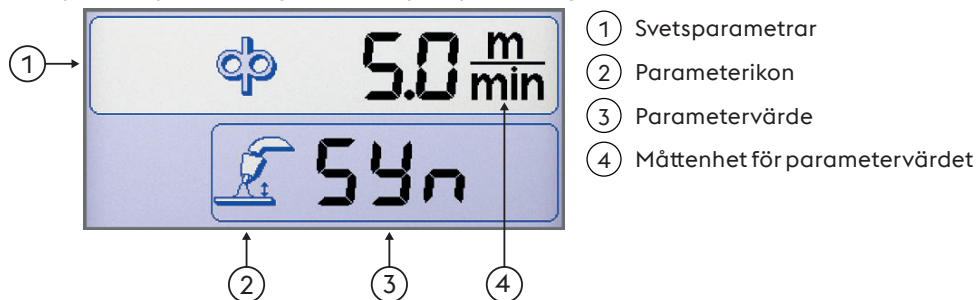

Svetsparametrar (Grafisk skärmbild)

► Välj önskad parameter genom att trycka på kodningsvredet.

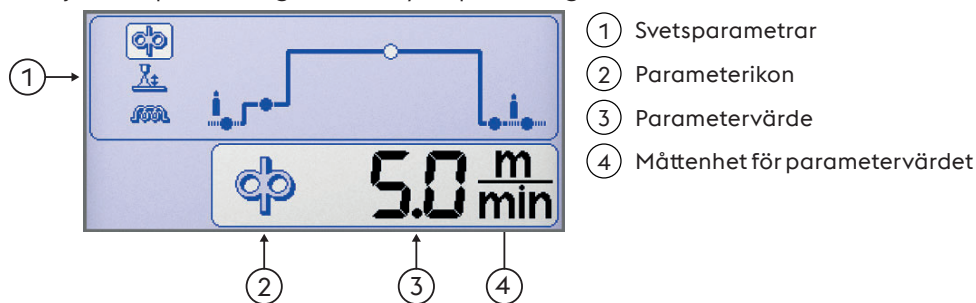

Funktioner

Medger inställning av de viktigaste processfunktionerna och svetsmetoderna.

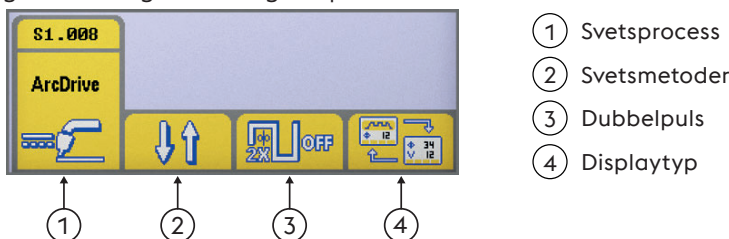

Svetsmetoder

Medger val av svetsmetod



2 steg

När knappen trycks in börjar gasen att flöda, matar spänning till tråden så att den matas fram; när knappen släpps stängs gasen, spänningen och trådmatningen av.



4 steg

Den första knapptryckningen får gasen att flöda med en manuell förgastid. När knappen sedan släpps aktiveras spänningen till tråden och trådmatningen. Följande knapptryckning stannar tråden och startar den slutliga processen där strömmen återgår till noll. När knappen släpps till sist stängs gasflödet av.



Crater filler

Möjliggör svetsning med tre olika effektnivåer som kan väljas direkt med brännarknappen.

Den första knapptryckningen får gasen att flöda, aktiverar spänningen till tråden och matar den med inställd hastighet och med de aktuella synergivärdena från svetsparametrarna.

När du släpper brännarknappen ändras tråd hastigheten och de aktuella synergiparametrarna automatiskt till de grundvärden som är inställda på kontrollpanelen.

Nästa gång du trycker på knappen ställs tråd hastigheten och de aktuella synergiparametrarna in på de förinställda parameter värdena för kraterfyllning.

När du släpper brännarknappen avbryts trådmatningen och det matas ström till burn back- och eftergasstegen.



Dubbelpuls



Dubbelpuls aktiv



Dubbelpuls inaktiv

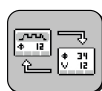

Displaytyp

Växlar mellan att visa följande:



Grundskärmbild



Grafisk skärmbild

Skärm med synergikurvor





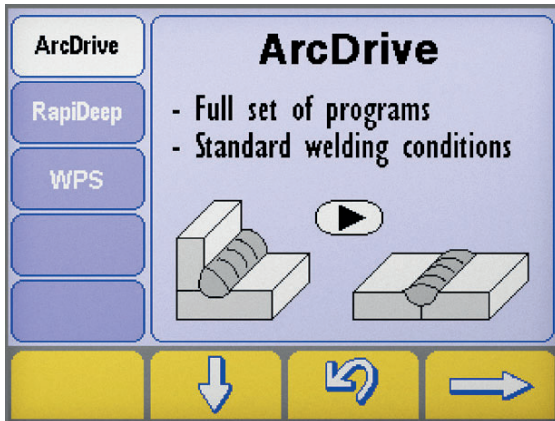

Synergi

Medger val av förinställt svetsprogram (synergi) genom att välja några enkla inställningar

Val av svetsprocess



- ▶ Gå till skärmbilden "synergier" genom att trycka på knappen  i minst 1 sekund.
- ▶ Välj önskad process genom att trycka på knapparna  e 
- ▶ Tryck på knappen  för att gå till nästa steg.



Skärmbild för val av synergi Typ av material/Typ av gas

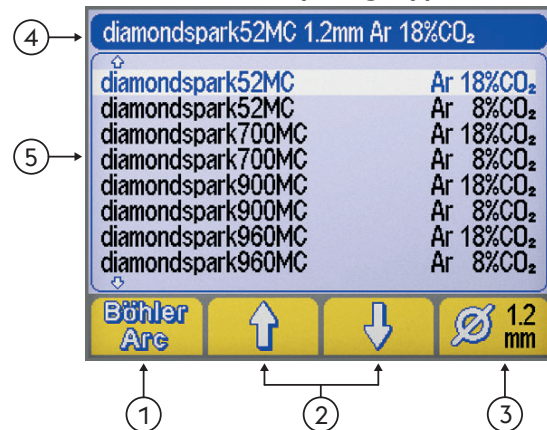

- ① Svetsprogram (BöhlerArc/UniversalArc)
- ② Val av material/gas
- ③ Wtråddiameter
- ④ Huvud
- ⑤ Svetsprogram

Böhler Arc Svetsprogram
Medger val av svetsprogram

Böhler Arc BöhlerArc **Univers. Arc** UniversalArc

↑ Val av material/gas
Medger val av:

- Typ av svetstråd
- Typ av gas



Wtråddiameter

Kan man välja tråddiameter (mm).

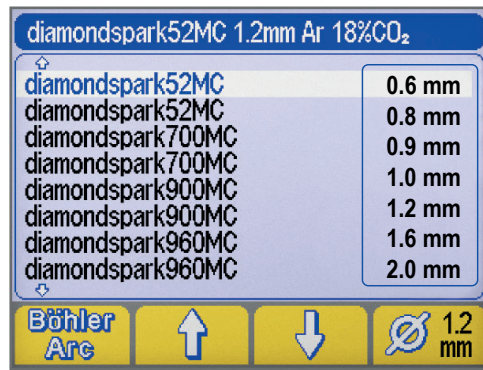

① Wtråddiameter

①



Huvud

Visar vissa viktiga uppgifter i relation till den valda processen.



NO PROGRAM

Indikerar att det valda synergiprogrammet inte är tillgängligt eller inte är kompatibelt med de övriga systeminställningarna.

5. SETUP

5.1 Set-up och ställa in parametrar

För inställning av en rad tilläggsparametrar som ger en bättre och mer precis hantering av svetsanläggningen. De set-upparametrar som visas är anpassade efter den valda svetsningen och har numeriska koder.

Att öppna set-up

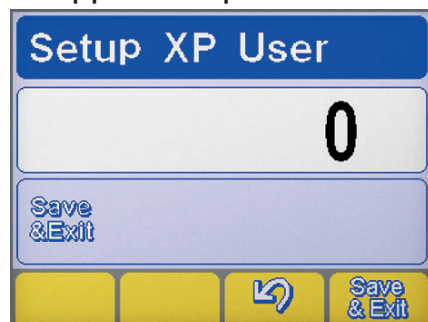

- ▶ Tryck på encodernappen i 5 sekunder.
- ▶ Åtkomsten bekräftas av att det står 0 på displayen.

Att välja och ställa in önskad parameter

- ▶ Trid på dataomvandlaren tills den numeriska koden för den önskade parametern visas.
- ▶ Tryck sedan på dataomvandlarknappen för att visa det inställda värdet för den valda parametern och ändra inställningen.

Att stänga set-up

- ▶ Tryck på dataomvandlaren igen för att gå ur "inställningssektionen".
- ▶ Gå till parametern "0" (spara och stäng) och tryck på dataomvandlarknappen för att gå ur set-up.
- ▶ Bekräfta åtgärden genom att trycka på knappen .
- ▶ Spara ändringen och gå ur set-up genom att trycka på knappen: .

5.1.1 Set-upparametrar (MMA)

0 Spara och stäng



För att spara ändringarna och gå ur set-up.

1 Återställning



För att återställa alla parametrarna till standardvärdena.

3 Hot start



För inställning av hot start-procenten vid MMA-svetsning.

För inställning av mer eller mindre "het" start för att underlätta tändningen av bågen.

Basisk elektrode

Minimum	Maximum	Standard
0/af	500%	80%

Cellulose elektrode

Minimum	Maximum	Standard
0/af	500%	150%

CrNi-elektrode

Minimum	Maximum	Standard
0/af	500%	100%

Aluminium elektrode

Minimum	Maximum	Standard
0/af	500%	120%

Gjutjärn elektrode

Minimum	Maximum	Standard
0/af	500%	100%

7 Svetsström



För inställning av svetsströmmen.

Minimum	Maximum	Standard
3 A	I _{max}	100 A

8 Arc force



För inställning av arc force-procenten vid MMA-svetsning.

Ger ett mer eller mindre energirikt dynamiskt svar under svetsningen för att underlätta svetsarens arbete.

Ökning av bågeffekten minskar risken för att elektroden ska fastna.

Basisk elektrode

Minimum	Maximum	Standard
0/af	500%	30%

Cellulose elektrode

Minimum	Maximum	Standard
0/af	500%	350%

CrNi-elektrode

Minimum	Maximum	Standard
0/af	500%	30%

Aluminium elektrode

Minimum	Maximum	Standard
0/af	500%	100%

Gjutjärn elektrode

Minimum	Maximum	Standard
0/af	500%	70%

204 Dynamic power control (DPC)



Möjliggör val av önskad V/I-karakteristik.

I=C Konstantström

Ökning eller minskning av båg höjden har ingen effekt på den svetsström som krävs.

Rekommenderas för elektrod: Basisk, Rutil, Sur, Stål, Gjutjärn

1:20 Minskande gradientkontroll

Ökningen av båg höjden orsakar en sänkning av svetsströmmen (och omvänt) enligt det värde som ges av 1 till 20 ampere per volt.

Rekommenderas för elektrod: Cellulosa, Aluminium

P=C Konstanteffekt

Ökningen av båg höjden orsakar en sänkning av svetsströmmen (och omvänt) enligt formeln: $V \cdot I = K$

Rekommenderas för elektrod: Cellulosa, Aluminium

312 Spänning för att bryta bågen



För inställning av det spänningsvärde vid vilket den elektriska bågen ska brytas.

Används för att hantera de olika driftförutsättningar som uppstår på bästa sätt.

Vid punktsvetsning blir till exempel den uppflammande lågan när elektroden tas bort från arbetsstycket mindre om bågen bryts vid en låg spänning, vilket innebär att det blir mindre stänk, brännskador och oxidation på arbetsstycket.

Om du använder elektroder som fordrar hög spänning bör du däremot ställa in en hög tröskel för att undvika att bågen släcks under svetsningen.



Ställ aldrig in en högre spänning för att bryta bågen än generatorns tomgångsström.

Basisk elektrode

Minimum	Maximum	Standard
0/af	99.9 V	57.0 V

Cellulose elektrode

Minimum	Maximum	Standard
0/af	99.9 V	70.0 V

399 Skärningshastighet



Medger inställning av svetsningshastighet.

Default cm/min: referenshastighet för manuell svetsning.

Syn: Sinergic värde.

Minimum	Maximum	Standard
1 cm/min	200 cm/min	15 cm/min

500 Maskininställning



Här kan man välja grafiskt gränssnitt.

Ger åtkomst till de högre inställningsnivåerna.

Se avsnittet "Anpassning av gränssnittet (Set up 500)"

Värde	Användargränssnitt
XE	Driftssättet Easy
XA	Driftssättet Advanced
XP	Driftssättet Professional

Värde	Vald nivå
USER	Användare
SERV	Service
vaBW	vaBW

551 Lock/unlock



Medger spärning av manöverpanelen och inmatning av en skyddskod.

Se avsnittet "Lock/unlock (Set up 551)".

552 Ljudsignal



För inställning av ljudsignalen.

Minimum	Maximum	Standard
0/af	10	10

601 Inställningssteg



Medger inställning av en parameter med ett steg som användaren kan bestämma själv.

Minimum	Maximum	Standard
1	lmax	1

602 Extern parameter CH1, CH2, CH3, CH4



Här kan man ställa in den externa parametern 1, 2, 3, 4 (minsta värde, största värde, förinställt värde, vald parameter).

Se avsnittet "Hantering av externa styrkommandon (Set up 602)".

705 Kalibrering av kretsmotstånd



Används för kalibrering av aggregatet.

Se avsnittet "Kalibrering av kretsmotstånd (set up 705)".

751 Strömstyrka



Medger visning av den faktiska svetsströmmen.

752 Spänning

Medger visning av den faktiska svetsspänningen.

768 Mätning av värmetillskott HI

Används för avläsning av mätvärdet för värmetillskott vid svetsningen.

801 Säkerhetsgränser

Medger inställning av varnings- och säkerhetsgränser.

Medger styrning av svetsprocessen med hjälp av varningsgränser och säkerhetsgränser för de viktigaste mätbara parametrarna.

För noggrann styrning av de olika svetsfaserna

Se avsnittet "Säkerhetsgränser (Set up 801)".

5.1.2 Lista över inställda parametrar (TIG)
0 Spara och stäng

För att spara ändringarna och gå ur set-up.

1 Återställning

För att återställa alla parametrarna till standardvärdena.

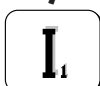
7 Svetsström

För inställning av svetsströmmen.

Minimum	Maximum	Standard
3 A	I _{max}	100 A

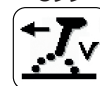
399 Skärningshastighet

Medger inställning av svetsningshastighet.

Default cm/min: referenshastighet för manuell svetsning.

Syn: Sinergic värde.

Minimum	Maximum	Standard
1 cm/min	200 cm/min	10 cm/min

500 Maskininställning

Här kan man välja grafiskt gränssnitt.

Ger åtkomst till de högre inställningsnivåerna.

Se avsnittet "Anpassning av gränssnittet (Set up 500)"

Värde	Användargränssnitt
XE	Driftssättet Easy
XA	Driftssättet Advanced
XP	Driftssättet Professional

Värde	Vald nivå
USER	Användare
SERV	Service
vaBW	vaBW

551 Lock/unlock

Medger spärning av manöverpanelen och inmatning av en skyddskod.

Se avsnittet "Lock/unlock (Set up 551)".

552 Ljudsignal

För inställning av ljudsignalen.

Minimum	Maximum	Standard
0/af	10	10

601 Inställningssteg

Medger inställning av en parameter med ett steg som användaren kan bestämma själv.

Minimum	Maximum	Standard
1	I _{max}	1

602 Extern parameter CH1, CH2, CH3, CH4



Här kan man ställa in den externa parametern 1, 2, 3, 4 (minsta värde, största värde, förinställt värde, vald parameter).

Se avsnittet "Hantering av externa styrkommandon (Set up 602)".

705 Kalibrering av kretsmotstånd



Används för kalibrering av aggregatet.

Se avsnittet "Kalibrering av kretsmotstånd (set up 705)".

751 Strömstyrka



Medger visning av den faktiska svetsströmmen.

752 Spänning



Medger visning av den faktiska svetsspänningen.

758 Robothastighet



Medger avläsning av hur fort armen på en robot eller en automatiserad enhet rör sig.

768 Mätning av värmestillskott HI



Används för avläsning av mätvärdet för värmestillskott vid svetsningen.

801 Säkerhetsgränser



Medger inställning av varnings- och säkerhetsgränser.

Medger styrning av svetsprocessen med hjälp av varningsgränser och säkerhetsgränser för de viktigaste mätbara parametrarna.

För noggrann styrning av de olika svetsfaserna

Se avsnittet "Säkerhetsgränser (Set up 801)".

5.1.3 Lista över inställda parametrar (MIG/MAG)

0 Spara och stäng



För att spara ändringarna och gå ur set-up.

1 Återställning



För att återställa alla parametrarna till standardvärdena.

2 Svetsprogram



MIG/MAG-Standard:

Gör att man kan välja den manuella ( Off) eller synergiska ( 6) MIG-processen genom att ställa in vilken typ av material som ska svetsas.

Pulsad MIG/MAG:

Gör att man kan välja synergiska ( 6) MIG-processen genom att ställa in vilken typ av material som ska svetsas.
Gör att man kan välja den CC/CV-processen.

3 Trådastighet



Medger inställning av trådmatningshastigheten.

Minimum	Maximum	Standard
0.5 m/min	22.0 m/min	-

4 Ström

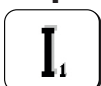

För inställning av svetsströmmen.

Minimum	Maximum
3 A	I _{max}

SV

5 Ämnestjocklek

Medger inställning av godstjockleken i arbetsstycket.
Systemet anpassas till arbetsstycket.

6 Hörfog "a"

Medger inställning av fogdjup i hörn.

10 För-gas

För att ställa in och reglera gasflödet innan bågen tänds.
Gör det möjligt att ladda gasen i brännaren och förbereda miljön för svetsningen.

Minimum	Maximum	Standard
0/af	99.9 s	0.1 s

11 Soft start



Gör det möjligt att ställa in trådmatningshastigheten i skedena före tändningen.
Medger tändning med reducerad hastighet, som därmed blir mjukare och ger mindre stänk.

Minimum	Maximum	Standard
10 %	100 %	50 %

12 Motorramp

För inställning av en stegvis övergång mellan trådhastigheten vid tändningen och under svetsningen.

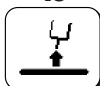
Minimum	Maximum	Standard
0/af	1.0 s	0/af

15 Burn back

Gör det möjligt att ställa in trådens bränntid och förhindra att den fastnar efter svetsningen.
Gör det möjligt att reglera längden på den del av tråden som befinner sig utanför brännaren.

Minimum	Maximum	Standard
-2.00	+2.00	0/syn

16 Efter-gas

För inställning av gasflödet vid slutet av svetsningen.

Minimum	Maximum	Standard
0/af	99.9 s	2.0 s

19 Duty cycle (dubbelpulsad)

Tillåt justering av driftcykeln i dubbelpulsat läge.

Minimum	Maximum	Standard
10 %	90 %	50 %

20 Dubbelpuls



Pulsamplituden kan ställas in.

Minimum	Maximum	Standard
0 %	100 %	±25 %
Minimum	Maximum	Standard
0.5 m/min	22 m/min	2.5 m/min

21 Pulsfrekvens (dubbelpulsad)

Medger inställning av cykeln, alltså pulsupprepningen.
Pulsfrekvensen kan ställas in.

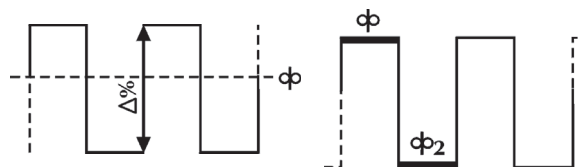
Minimum	Maximum	Standard
0.1 Hz	5.0 Hz	2.0 Hz



22 Sekundärspänning (dubbelpulsad)



Medger inställning av spänningen för sekundärpulserna.
Det går att få en stabilare båge under de olika faserna i pulsrytmen.

Minimum	Maximum	Standard
-5.0	+5.0	0/syn

23 Pulsramper (dubbelpulsad)



Inställning av stegrings- eller minskningstid under pulsdrift.

Minimum	Maximum	Standard
1 %	100 %	50 %

24 Bilevel (4T - crater filler)



För inställning av sekundärtrådmattningshastighet vid bilevel-svetsning.

Om man trycker på knappen och snabbt släpper den igen övergår strömmen till "φ₂".

Tryck på knappen och släpp den genast för att gå tillbaka till "φ", och vice versa för.

Minimum	Maximum	Standard
1 %	200 %	0/af

25 Startstöt



Medger inställning av trådmattningshastigheten under den första svetsfasen med "kraterfyllning".

Energitillförseln till arbetsstycket kan ökas när materialet fortfarande är kallt och behöver mer ström för att smälta i jämn takt.

Minimum	Maximum	Standard
20 %	200 %	120 %

26 Crater filler



Medger inställning av trådmattningshastigheten under den avslutande svetsfasen med "kraterfyllning".

Strömmen kan reduceras under den fas när materialet är kraftigt upphettat, vilket minskar risken för oönskade deformationer.

Minimum	Maximum	Standard
20 %	200 %	80 %

27 Första stegringstid



Medger inställning av första stegringstid.

Medger automatisering av kraterfyllningsfunktionen.

Minimum	Maximum	Standard
0.1 s	99.9 s	0/af

28 Kraterfyllningstid



Medger inställning av kraterfyllningstid.

Medger automatisering av kraterfyllningsfunktionen.

Minimum	Maximum	Standard
0.1 s	99.9 s	0/af

30 Punktsvetsning

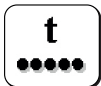

Gör att du kan aktivera punktsvetsningsprocessen och bestämma svetsningstiden.

Minimum	Maximum	Standard
0.1 s	99.9 s	0/af

31 Punktsvetsning med pauser

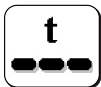

För inkoppling av punktsvetsning med pauser och inställning av paustiden mellan svetsningarna.

Minimum	Maximum	Standard
0.1 s	99.9 s	0/af

32 Sekundärspänning (Bilevel MIG)



Medger inställning av spänningen för sekundärpulserna.

Det går att få en stabilare båge under de olika faserna i pulsrytmen.

Minimum	Maximum	Standard
-5.0	+5.0	0/syn

33 Sekundärinduktans (Bilevel MIG)

Medger inställning av induktans för sekundärpulserna.

Bågen kan på så sätt göras snabbare eller långsammare för att kompensera för svetsarens rörelser och för den naturliga instabiliteten i svetsförloppet.

Låg induktans = reaktiv båge (mer stänk).

Hög induktans = mindre reaktiv båge (mindre stänk).

Minimum	Maximum	Standard
-30	+30	0/syn

34 Initial ökningsramp

Används för att ställa in en gradvis övergång från den initiala trådhastigheten till svetsningshastigheten.

Minimum	Maximum	Standard
0 s	10 s	0/af

35 Kraterfyllningsramp

Används för att ställa in en gradvis övergång från svetsningshastigheten till kraterfyllningshastigheten.

Minimum	Maximum	Standard
0 s	10 s	0/af

202 Induktans

Medger elektronisk inställning av svetskretsens serieinduktans.

Bågen kan på så sätt göras snabbare eller långsammare för att kompensera för svetsarens rörelser och för den naturliga instabiliteten i svetsförloppet.

Låg induktans = reaktiv båge (mer stänk).

Hög induktans = mindre reaktiv båge (mindre stänk).

Minimum	Maximum	Standard
-30	+30	0/syn

331 Kompenserad medelspänning

Medger inställning av svetsspänning.

398 Referenskonstant för förflyttningshastighet

Referenskonstant för samtliga svetsprocesser

Värde för brännarens förflyttningshastighet som aggregatet använder för att beräkna svetsparametrar

399 Skärningshastighet

Medger inställning av svetsningshastighet.

Default cm/min: referenshastighet för manuell svetsning.

Syn: Sinergic värde.

Minimum	Maximum	Standard
syn min	syn max	35 cm/min

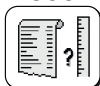
500 Maskininställning

Här kan man välja grafiskt gränssnitt.

Ger åtkomst till de högre inställningsnivåerna.

Se avsnittet "Anpassning av gränssnittet (Set up 500)"

Värde	Användargränssnitt	Värde	Vald nivå
XE	Driftssättet Easy	USER	Användare
XA	Driftssättet Advanced	SERV	Service
XP	Driftssättet Professional	vaBW	vaBW

551 Lock/unlock

Medger spärning av manöverpanelen och inmatning av en skyddskod.

Se avsnittet "Lock/unlock (Set up 551)".

552 Ljudsignal

För inställning av ljudsignalen.



Minimum	Maximum	Standard
0/af	10	10

601 Inställningssteg

Medger inställning av en parameter med ett steg som användaren kan bestämma själv. Funktionalitet som styrs av upp / ner-knappen.



Minimum	Maximum	Standard
1	Imax	1

602 Extern parameter CH1, CH2, CH3, CH4

Här kan man ställa in den externa parametern 1, 2, 3, 4 (minsta värde, största värde, förinställt värde, vald parameter).

Se avsnittet "Hantering av externa styrkommandon (Set up 602)".

**606 U/D-brännare**

Här kan man ställa in den externa parametern (U/D).



Värde	Standard	Återuppringsfunktion
0/af	-	af
1/11	X	Ström
	-	Hämtning av program

612 Brännarinställning DgMig

Används för att styra den digitala brännarens kanaler.



Värde	Standard	Återuppringsfunktion
0/af	-	af
1/11	-	Ström
2/ 	-	Hämtning av program
3/CH3	-	CH3
4/CH4	-	CH4
5/STD	X	STD

653 Tråd hastighet

Medger inställning av trådmatningshastigheten (under lastningssteget).



Minimum	Maximum	Standard
0.5 m/min	22.0 m/min	3.0 m/min

705 Kalibrering av kretsmotstånd

Används för kalibrering av aggregatet.

Se avsnittet "Kalibrering av kretsmotstånd (set up 705)".

**751 Strömstyrka**

Medger visning av den faktiska svetsströmmen.

**752 Spänning**

Medger visning av den faktiska svetsspänningen.

**755 Avläsning av gasflödet**

Det faktiska gasflödet kan läsas av.



757 Trådastighet

Visar värdet för motorkodare 1.

758 Robothastighet

Medger avläsning av hur fort armen på en robot eller en automatiserad enhet rör sig.

760 Strömstyrka (motor 1)

Medger visning av den faktiska motorströmmen (motor 1).

768 Mätning av värmestillskott HI

Används för avläsning av mätvärdet för värmestillskott vid svetsningen.

770 Insvetstal

Används för att visa insvetstalet.

801 Säkerhetsgränser

Medger inställning av varnings- och säkerhetsgränser.

Medger styrning av svetsprocessen med hjälp av varningsgränser och säkerhetsgränser för de viktigaste mätbara parametrarna.

För noggrann styrning av de olika svetsfaserna



Se avsnittet "Säkerhetsgränser (Set up 801)".

5.2 Särskilda procedurer för användning av parametrar

5.2.1 Anpassning av 7-segmentsdisplayen

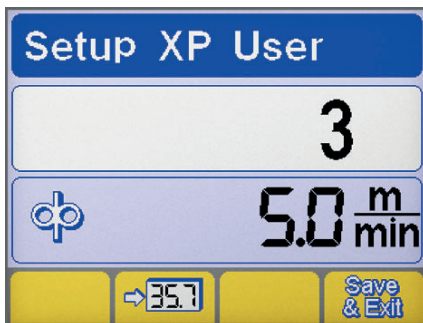
Används för att visa ett parametervärde konstant på 7-segmentsdisplayen.



- ▶ Gå till SetUp genom att hålla kodningsvredet intryckt under minst 5 sekunder.
- ▶ Välj önskad parameter genom att vrida på kodningsvredet.
- ▶ Lagra den valda parametern i 7-segmentsdisplayen genom att trycka på knappen .
- ▶ Spara och lämna skärmen genom att trycka på knappen .

SV

5.2.2 Anpassning av gränssnittet (Set up 500)

Parametrarna kan anpassas i huvudmenyn.

500 Maskininställning

Här kan man välja grafiskt gränssnitt.

Värde	Användargränssnitt
XE	Driftsättet Easy
XA	Driftsättet Advanced
XP	Driftsättet Professional

DRIFTSÄTT XE

MIG/MAG	
Svetsparametrar	
Funktioner	

DRIFTSÄTT XA

MIG/MAG	
Svetsparametrar	
Funktioner	

DRIFTSÄTT XP

MIG/MAG	
Svetsparametrar	
Funktioner	

5.2.3 Lock/unlock (Set up 551)

Medger spärning av manöverpanelen och inmatning av en skyddskod.

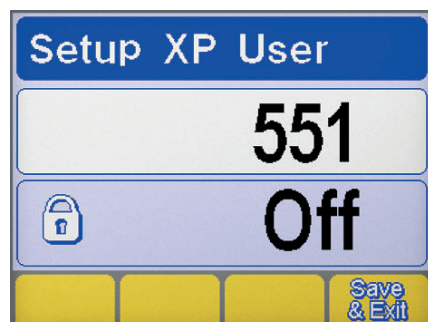

Val av parameter

- ▶ Gå till SetUp genom att hålla kodningsvredet intryckt under minst 5 sekunder.
- ▶ Välj parameter (551).
- ▶ Aktivera inställning av vald parameter genom att trycka på kodningsknappen.

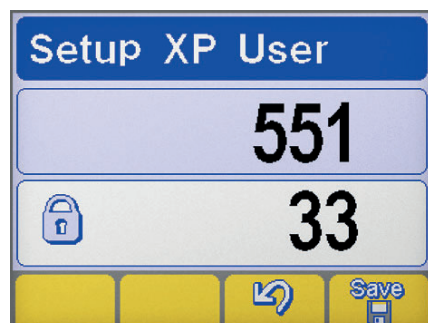

Inställning av lösenord

- ▶ Ställ in en numerisk kod (ett lösenord) genom att vrida på kodningsvredet.
- ▶ Bekräfta momentet genom att trycka på encoderknappen.
- ▶ Bekräfta åtgärden genom att trycka på knappen .
- ▶ Spara ändringen genom att trycka på knappen: .

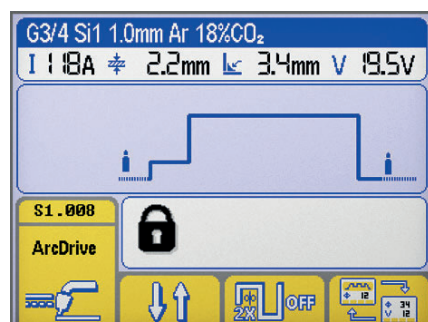

Panelfunktioner

- ▶ Gå till panelfunktionerna tillfälligt (under 5 minuter) genom att vrida på kodningsvredet och mata in lösenordet (koden).
- ▶ Bekräfta momentet genom att trycka på encoderknappen.
- ▶ Manöverpanelen frisläpps permanent om man går till Set-up (se anvisningarna ovan) och ändrar parameter 551 till OFF.
- ▶ Bekräfta momentet genom att trycka på encoderknappen.
- ▶ Spara ändringen genom att trycka på knappen: .

5.2.4 Hantering av externa styrkommandon (Set up 602)

Här kan man ställa in den externa parametern 2 (minsta värde, största värde, förinställt värde, vald parameter).



Val av parameter

- ▶ Gå till SetUp genom att hålla kodningsvredet intryckt under minst 5 sekunder.
- ▶ Välj parameter (602).
- ▶ Gå till skärmen "Hantering av externa styrkommandon" genom att trycka på kodningsvredet.

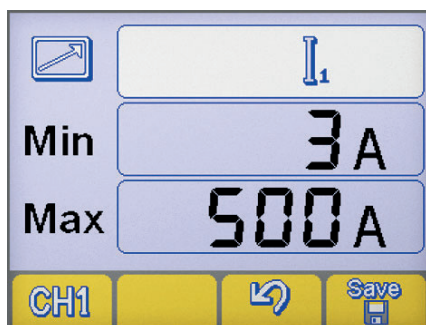

Hantering av externa styrkommandon

- ▶ Välj RC-fjärrkontrollutgång (CH1, CH2, CH3, CH4) genom att trycka på knappen. **CH1**
- ▶ Välj önskad parameter (MIN-MAX-parameter) genom att trycka på kodningsvredet.
- ▶ Ställ in värdet på önskad parameter (MIN-MAX-parameter) genom att vrida på kodningsvredet.
- ▶ Spara ändringen genom att trycka på knappen: **Save**.
- ▶ Bekräfta åtgärden genom att trycka på knappen **Save**.

5.2.5 Kalibrering av kretsmotstånd (set up 705)

Används för att kalibrera generatorn utifrån den aktuella svetskretsens motstånd.

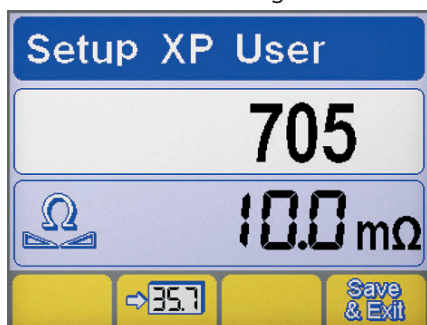

Val av parameter

- ▶ Gå till SetUp genom att hålla kodningsvredet intryckt under minst 5 sekunder.
- ▶ Välj parameter (705).
- ▶ Aktivera inställning av vald parameter genom att trycka på kodningsknappen.
- ▶ Anslut generatorn till svetskretsen (arbetsbord eller arbetsstycke).
- ▶ Ta bort hättan för att montera munstyckeshållarens spets på brännaren. (MIG/MAG)

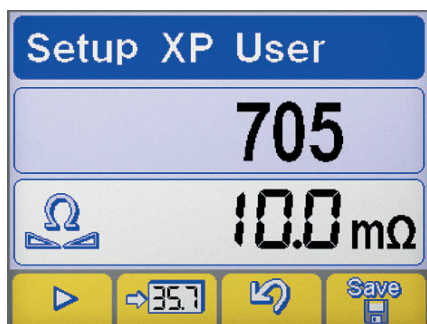

Kalibrering

- ▶ Sätt trådguidens spets i elektrisk kontakt med arbetsstycket. (MIG/MAG)
- ▶ Tryck på knappen **▶** för att börja proceduren.
- ▶ Upprätthåll kontakten i minst 1 sekund.
- ▶ Värdet som visas på displayen uppdateras efter kalibreringen.
- ▶ Bekräfta åtgärden genom att trycka på knappen **Save**.
- ▶ Bekräfta åtgärden genom att trycka på knappen **Save**.
- ▶ Spara ändringen och gå ur set-up genom att trycka på knappen: **Save & Exit**.

5.2.6 Säkerhetsgränser (Set up 801)

Medger inställning av varnings- och säkerhetsgränser.

Medger styrning av svetsprocessen med hjälp av varningsgränser och säkerhetsgränser för de viktigaste mätbara parametrarna.

För noggrann styrning av de olika svetsfaserna

Se avsnittet "Säkerhetsgränser (Set up 801)".

Uppmärksamhetsgränser			Säkerhetsgränser		
-----------------------	--	--	------------------	--	--

- | | |
|---|---|
| <ul style="list-style-type: none"> Svetsström Avläsning av gasflödet Strömstyrka (motor 1) Kylmedelsflöde Avläsning kylmedelstemperatur | <ul style="list-style-type: none"> Arbetsspänning Robothastighet Strömstyrka (motor 2) Trådastighet |
|---|---|

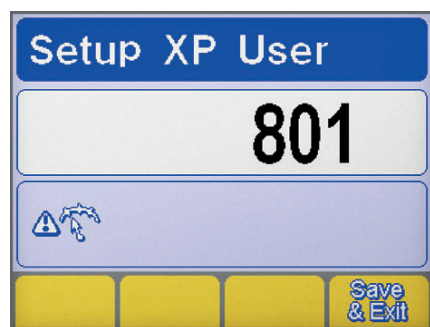

Val av parameter

- ▶ Gå till SetUp genom att hålla kodningsvredet intryckt under minst 5 sekunder.
- ▶ Välj parameter (801).
- ▶ Gå till skärmen "Säkerhetsgränser" genom att trycka på kodningsvredet.

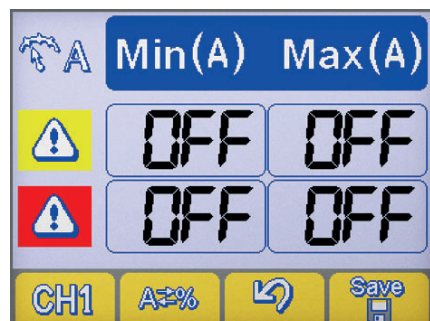

Val av parametern

- ▶ Välj önskad parameter genom att trycka på knappen **CH1**.
- ▶ Välj metod för inställning av säkerhetsgränserna genom att trycka på knappen **A=%**.

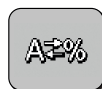

Maskininställning



Absolutvärde



Procentvärde

Inställning av larmgränser

- ① Rad för varningsgränser
- ② Rad för larmgränser
- ③ Spalt för lägsta nivå
- ④ Spalt för högsta nivå

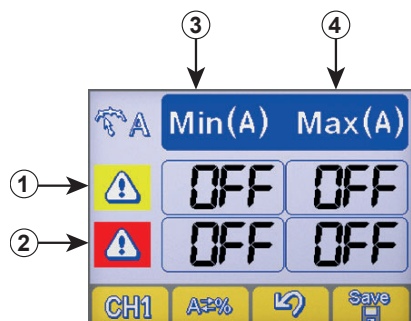

- ▶ Välj önskat fält genom att trycka på kodningsvredet (det valda fältet markeras genom omvänd kontrast).
- ▶ Modifiera värdet på den valda gränsen genom att vrida på kodningsvredet.
- ▶ Spara ändringen genom att trycka på knappen:

SV



- När en varningsgräns passeras avges en visuell varning på manöverpanelen.
- När en larmgräns passeras visas ett visuellt larm på manöverpanelen och svetsprocessen avbryts.
- Man kan ställa in filter för tändningen och släckningen av ljusbågen så att inga larm avges då (se avsnittet "Set Up" -Parametrarna 802-803-804).

6. TILLBEHÖR

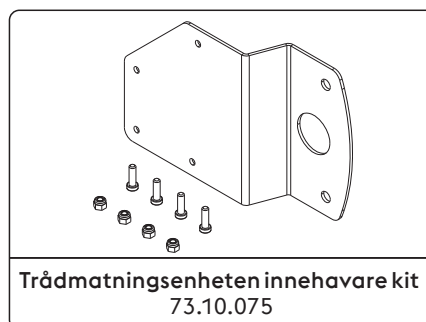
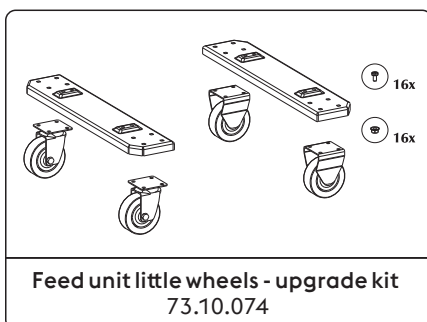
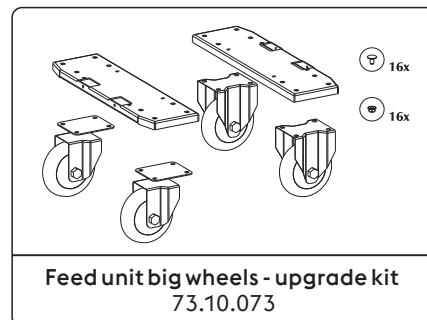
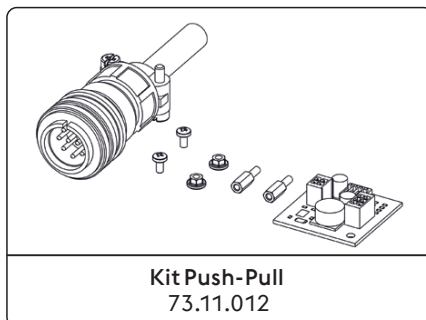
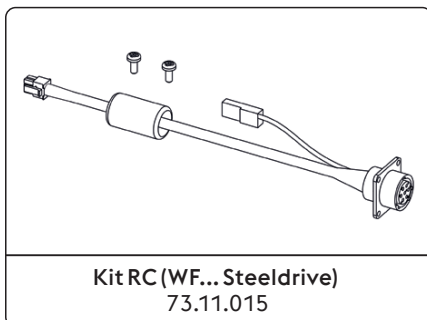

*Fabrik löpande

Se avsnittet "Installation kit/tillbehör".

7. UNDERHÅLL



Anläggningen ska genomgå löpande underhåll i enlighet med tillverkarens instruktioner. Alla luckor och kåpor ska vara stängda och ordentligt fastsatta när apparaten är i drift. Aggregatet får inte modifieras på något sätt. Om detta underhåll inte utförs upphör alla garantier att gälla och tillverkaren kan inte utkrävas något ansvar för konsekvenserna.



Eventuellt underhåll får endast utföras av utbildad personal. Om obehörig personal reparerar aggregatet eller byter ut delar av det upphör produktgarantin omedelbart att gälla. Eventuella reparationer och utbyte av delar av aggregatet får endast utföras av kompetent teknisk personal.



Stäng av strömförsörjningen till aggregatet före alla ingrepp!

7.1 Periodiska kontroller av generatorm



Rengör generatorm invändigt med tryckluft med lågt tryck och pensel med mjuk borst. Kontrollera de elektriska anslutningarna och alla kabelkopplingar.

7.2 Odpowiedzialność



Om detta underhåll inte utförs upphör alla garantier att gälla och tillverkaren kan inte utkrävas något ansvar för konsekvenserna. Tillverkaren påtar sig inget ansvar om operatören inte följer dessa anvisningar. Kontakta närmaste serviceverkstad vid tveksamheter och/eller problem.























































SV

8. LARMKODER

LARM
Om ett larm utlöses eller en kritisk övervakningsgräns överskrids visas en ljussignalering på kontrollpanelen och svetsningen blockeras omedelbart.

OBS
Om en larmgräns överskrids visas en ljussignalering på kontrollpanelen men svetsningen behöver inte avbrytas.

Nedan listas samtliga larm och övervakningsgränser för systemet.

 E01	Överhettning		 E02	Överhettning	
 E05	Överström		 E07	Fel på systemet för strömförsörjning av trådmatningens motor	
 E08	Blockerad motor		 E10	Överström hos effektmodul (Inverter)	
 E12.1	Kommunikationsfel WF1		 E13	Kommunikationsfel (FP)	
 E14.xx	Ogiltigt program felets underkod anger det borttagna programnumret		 E15	Ogiltigt program	
 E16.1	Kommunikationsfel RI 1000/2000/3000 (CAN bus)		 E16.2	Kommunikationsfel RI 3000 (Modbus)	
 E16.3	Kommunikationsfel RI 1000/2000		 E18.xx	Ogiltigt program felets underkod anger det borttagna programnumret	
 E19	Fel systemkonfiguration		 E19.1	Fel systemkonfiguration	
 E19.11	Fel systemkonfiguration (WF)		 E20	Defekt minne	
 E21	Förlust av data		 E23	Det finns inga svetsprogram	
 E27	Defekt minne (RTC)		 E32	Förlust av data	
 E33.1	Fel systemkonfiguration (LCD 3.5")		 E33.3	Kommunikationsfel (ACTIVATION KEY)	
 E33.4	Kommunikationsfel (ACTIVATION KEY)		 E40	Fel strömförsörjning av aggregatet	
 E43	Saknas kylvätska		 E44	Saknas gas	

 E48	Saknas tråd (Automation och robotteknik)		 E50	Fastklistrad tråd (Automation och robotteknik)	
 E54	Överskriden strömnivå (Nedre gräns)		 E55	Överskriden strömnivå (Övre gräns)	
 E56	Överskriden spänningsnivå (Nedre gräns)		 E57	Överskriden spänningsnivå (Övre gräns)	
 E58	Överskriden flödesnivå för gas (Nedre gräns)		 E59	Överskriden flödesnivå för gas (Övre gräns)	
 E62	Överskriden strömnivå (Nedre gräns)		 E63	Överskriden strömnivå (Övre gräns)	
 E64	Överskriden spänningsnivå (Nedre gräns)		 E65	Överskriden spänningsnivå (Övre gräns)	
 E66	Överskriden flödesnivå för gas (Nedre gräns)		 E67	Överskriden flödesnivå för gas (Övre gräns)	
 E71	Överhettad kylvätska		 E74	Överskriden strömnivå för motor 1	
 E76	Överskriden flödesnivå för kylvätska		 E77	Temperaturnivå för kylvätska	
 E80	Saknas tråd (wire end)		 E81	Överström (pump WU)	
 E82	Kommunikationsfel (WU)		 E83	Blockerad pump	
 E99.2	Larm vid fel på systemkonfigurationen (inverter)		 E99.3	Larm vid fel på systemkonfigurationen (FP)	
 E99.4	Larm vid fel på systemkonfigurationen (FP)		 E99.5	Larm vid fel på systemkonfigurationen (FP)	
 E99.6	Larm vid fel på systemkonfigurationen		 E99.11	Defekt minne	

9. FELSÖKNING OCH TIPS

Trådmatningen blockerad

Orsak

- » Fel på brännarknappen.
- » Felinställda eller utslitna valsar.
- » Fel på kuggväxelmotorn.
- » Brännarmanteln skadad.
- » Ingen ström till trådmatningen.
- » Oregelbunden upplindning på rullen.
- » Brännarmunstycket har smält (tråden sitter fast).

Lösning

- » Byt ut den skadade komponenten.
- » Kontakta närmaste serviceverkstad för reparation av aggregatet.
- » Byt ut valsarna.
- » Byt ut den skadade komponenten.
- » Kontakta närmaste serviceverkstad för reparation av aggregatet.
- » Byt ut den skadade komponenten.
- » Kontakta närmaste serviceverkstad för reparation av aggregatet.
- » Kontrollera anslutningen till aggregatet.
- » Se avsnittet "Anslutning".
- » Kontakta närmaste serviceverkstad för reparation av aggregatet.
- » Återställ normala upplindningsförhållanden eller byt ut rullen.
- » Byt ut den skadade komponenten.

Oregelbunden trådmatning

Orsak

- » Fel på brännarknappen.
- » Felinställda eller utslitna valsar.
- » Fel på kuggväxelmotorn.
- » Brännarmanteln skadad.
- » Trådrullens friktion eller låsanordningarna för rullarna felinställda.

Lösning

- » Byt ut den skadade komponenten.
- » Kontakta närmaste serviceverkstad för reparation av aggregatet.
- » Byt ut valsarna.
- » Byt ut den skadade komponenten.
- » Kontakta närmaste serviceverkstad för reparation av aggregatet.
- » Byt ut den skadade komponenten.
- » Kontakta närmaste serviceverkstad för reparation av aggregatet.
- » Minska friktionen.
- » Öka trycket på rullarna.

Slagginneslutningar

Orsak

- » Otillräcklig slaggborttagning.
- » För stor elektroddiameter.
- » Felaktig förberedelse av kanterna.
- » Felaktigt utförd svetsning.

Lösning

- » Rengör arbetsstyckena ordentligt innan svetsningen.
- » Använd en elektrod med mindre diameter.
- » Öka diktjärnets öppning.
- » Minska avståndet mellan elektroden och arbetsstycket.
- » Arbeta jämnt under alla svetsningsfaserna.

Blåsor

Orsak

- » Otillräcklig skyddsgas.

Lösning

- » Justera gasflödet.
- » Kontrollera att brännarens diffusor och munstycke är i gott skick.

Ingen sammansmältning

Orsak

- » Felaktig bågglängd.
- » Felaktiga parametrar för svetsningen.
- » Felaktigt utförd svetsning.
- » Stora arbetsstycken som ska svetsas.
- » Felaktig bågdyamik.

Lösning

- » Öka avståndet mellan elektroden och arbetsstycket.
- » Öka arbetsspänningen.
- » Öka svetsströmmen.
- » Öka arbetsspänningen.
- » Öka brännarens lutning.
- » Öka svetsströmmen.
- » Öka arbetsspänningen.
- » Öka induktansen i kretsen.

Sidoskåror
Orsak

- » Felaktiga parametrar för svetsningen.
- » Felaktig båglängd.
- » Felaktigt utförd svetsning.
- » Otillräcklig skyddsgas.

Lösning

- » Minska arbetsspänningen.
- » Minska avståndet mellan elektroden och arbetsstycket.
- » Minska arbetsspänningen.
- » Sänk oscillationshastigheten i sidled under fyllningen.
- » Sänk frammatningshastigheten för svetsning.
- » Använd gas som lämpar sig för det material som ska svetsas.

Oxidering
Orsak

- » Otillräcklig skyddsgas.

Lösning

- » Justera gasflödet.
- » Kontrollera att brännarens diffusor och munstycke är i gott skick.

Porositet
Orsak

- » Fett, färg, rost eller smuts på de arbetsstycken som ska svetsas.
- » Fett, färg, rost eller smuts på svetsmaterialet.
- » Fukt i svetsmaterialet.
- » Felaktig båglängd.
- » Fukt i svetsgasen.
- » Otillräcklig skyddsgas.
- » Smältbadet stelnar för snabbt.

Lösning

- » Rengör arbetsstyckena ordentligt innan svetsningen.
- » Använd alltid produkter och material med hög kvalitet.
- » Håll alltid svetsmaterialet i perfekt skick.
- » Använd alltid produkter och material med hög kvalitet.
- » Håll alltid svetsmaterialet i perfekt skick.
- » Minska avståndet mellan elektroden och arbetsstycket.
- » Minska arbetsspänningen.
- » Använd alltid produkter och material med hög kvalitet.
- » Se till att systemet för gasförsörjning hålls i perfekt skick.
- » Justera gasflödet.
- » Kontrollera att brännarens diffusor och munstycke är i gott skick.
- » Sänk frammatningshastigheten för svetsning.
- » Värm upp de arbetsstycken som ska svetsas i förväg.
- » Öka svetsströmmen.

Varmsprickor
Orsak

- » Felaktiga parametrar för svetsningen.
- » Fett, färg, rost eller smuts på de arbetsstycken som ska svetsas.
- » Fett, färg, rost eller smuts på svetsmaterialet.
- » Felaktigt utförd svetsning.
- » Arbetsstycken med olika egenskaper.

Lösning

- » Minska arbetsspänningen.
- » Rengör arbetsstyckena ordentligt innan svetsningen.
- » Använd alltid produkter och material med hög kvalitet.
- » Håll alltid svetsmaterialet i perfekt skick.
- » Utför rätt driftmoment för den fog som ska svetsas.
- » Buttra innan svetsningen.

Kallsprickor
Orsak

- » Fukt i svetsmaterialet.
- » Speciell form på den fog som ska svetsas.

Lösning

- » Använd alltid produkter och material med hög kvalitet.
- » Håll alltid svetsmaterialet i perfekt skick.
- » Värm upp de arbetsstycken som ska svetsas i förväg.
- » Värm upp arbetsstyckena efteråt.
- » Utför rätt driftmoment för den fog som ska svetsas.

10. ARBETSINSTRUKTIONER

10.1 Svetsning med kontinuerlig tråd (MIG/MAG)

Inledning

Ett MIG-system består av en likströmgenerator, en matningsanordning och en trådrulle, en brännare samt gas.

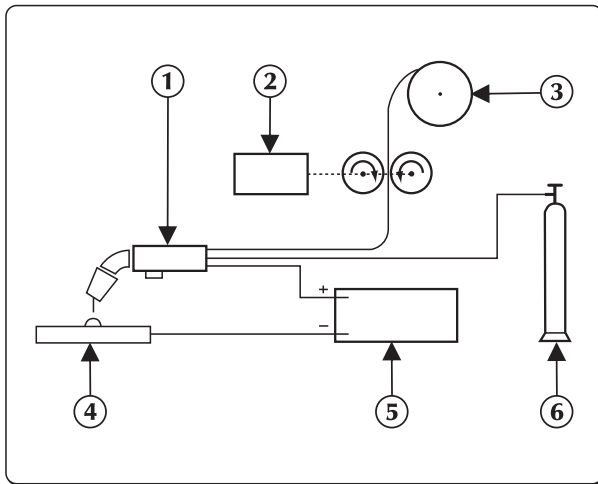

Manuellt svetsaggregat

Strömmen passerar den avsmältande elektroden (tråd med positiv polaritet);

Vid denna process överförs den smälta metallen på arbetsstycket genom bågen.

Tråden måste matas fram för att ersätta den elektrod som smälter under svetsningen.

1. Brännare
2. Trådmatningsenhet
3. Svetstråd
4. Arbetsstycke
5. Generatorn
6. Gasflaska

Tillvägagångssätt

Vid svetsning med skyddsgas kan dropparna överföras från elektroden på två olika sätt.

Den första metoden kallas "ÖVERFÖRING MED KORTSLUTNING (SHORT-ARC)". Här kommer elektroden i direkt kontakt med smältbadet, varefter en kortslutning sker. Tråden fungerar som en säkring och smälter. Därefter tänds bågen igen och cykeln upprepas.

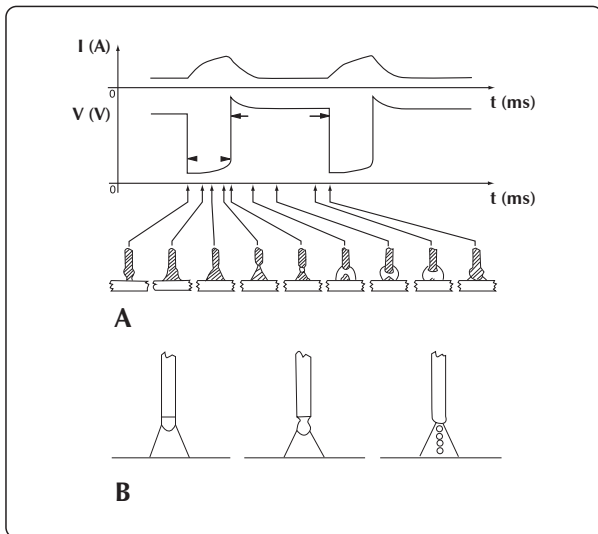

Cykel vid SHORT ARC respektive SPRAY ARC

Ett annat sätt att överföra dropparna är så kallad "ÖVERFÖRING MED STRÅLE (SPRAY-ARC)", där dropparna först lösgör sig från elektroden och sedan hamnar i smältbadet.

Svetsparametrar

Eftersom bågen är synlig minskar behovet att strikt hålla sig till inställningstabellerna: du har direkt kontroll över smältbadet.

- Spänningen inverkar direkt på svetssträngens utseende, men den svetsade ytans storlek kan du variera efter behov genom att manuellt flytta brännaren så att beläggningen blir olika med konstant spänning.
- Trådmatningshastigheten står i relation till svetsströmmen.

I följande två figurer visas förhållandena mellan de olika svetsparametrarna.

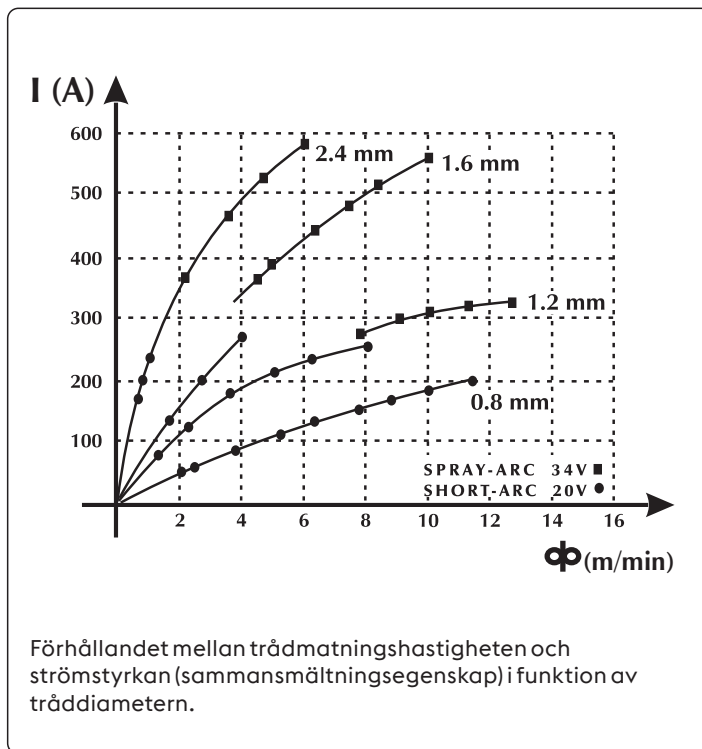
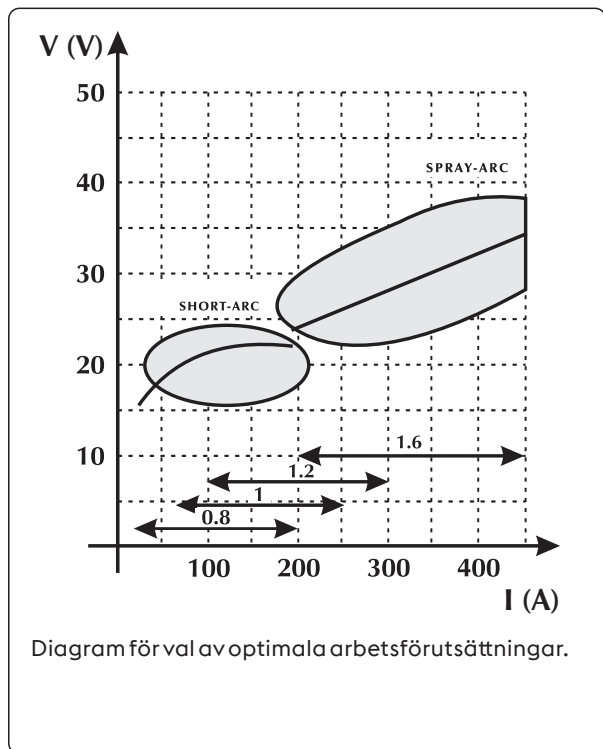

Vägledande tabell för val av svetsningsparametrar för de mest typiska användningsområdena och de vanligaste trådarna

Bågspänning	Ø 0,8 mm	Ø 1,0-1,2 mm	Ø 1,6 mm	Ø 2,4 mm
16V - 22V SHORT - ARC	 60 - 160 A Låg inträngning för små tjocklekar	 100 - 175 A God kontroll över inträngning och sammansmältning	 120 - 180 A God sammansmältning horisontellt och vertikalt	 150 - 200 A Används ej
24V - 28V PUOLILYHYTKAARI (SEMI SHORT-ARC) (Övergångszon)	 150 - 250 A Automatisk kälsvetsning	 200 - 300 A Automatisk svetsning med hög spänning	 250 - 350 A Automatisk svetsning nedåt	 300 - 400 A Används ej
30V - 45V SPRAY - ARC	 150 - 250 A Låg inträngning med inställning på 200 A	 200 - 350 A Automatisk svetsning med flera svetssträngar	 300 - 500 A God inträngning nedåt	 500 - 750 A God inträngning och hög deposition på stora tjocklekar

SV

Unalloyed steel

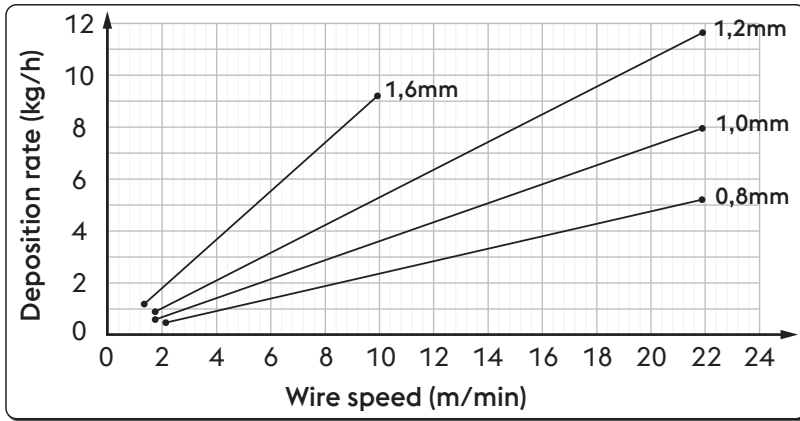

Ø	Wire speed	Deposition rate
0,8 mm	2,0 m/min	0,5 kg/h
	22,0 m/min	5,3 kg/h
1,0 mm	1,6 m/min	0,6 kg/h
	22,0 m/min	8,1 kg/h
1,2 mm	1,6 m/min	0,9 kg/h
	22,0 m/min	11,7 kg/h
1,6 mm	1,2 m/min	1,1 kg/h
	10,0 m/min	9,4 kg/h

High alloyed steel

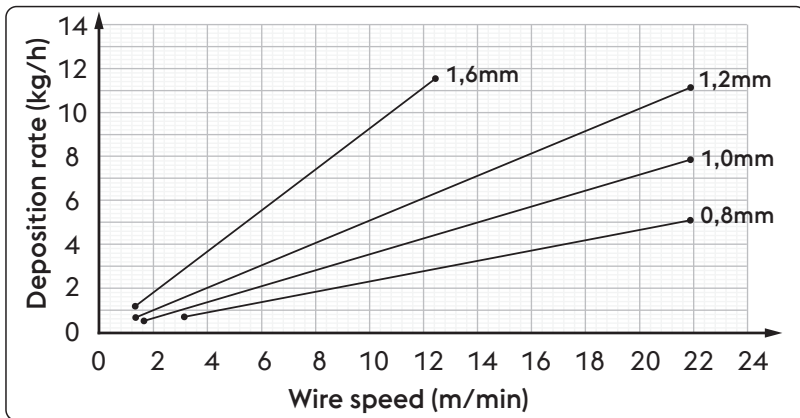

Ø	Wire speed	Deposition rate
0,8 mm	2,0 m/min	0,5 kg/h
	22,0 m/min	5,3 kg/h
1,0 mm	1,6 m/min	0,6 kg/h
	22,0 m/min	8,1 kg/h
1,2 mm	1,6 m/min	0,9 kg/h
	22,0 m/min	11,7 kg/h
1,6 mm	1,2 m/min	1,1 kg/h
	10,0 m/min	9,4 kg/h

Aluminum alloy

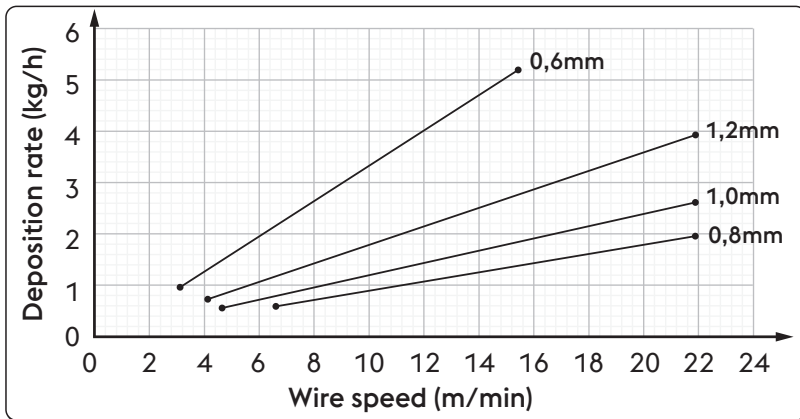

Ø	Wire speed	Deposition rate
0,8 mm	6,5 m/min	0,6 kg/h
	22,0 m/min	2,0 kg/h
1,0 mm	4,5 m/min	0,5 kg/h
	22,0 m/min	2,6 kg/h
1,2 mm	4,0 m/min	0,7 kg/h
	22,0 m/min	4,0 kg/h
1,6 mm	3,0 m/min	0,9 kg/h
	15,5 m/min	5,2 kg/h

SV

Gaser som kan användas

MIG-/MAG-svetsning kännetecknas huvudsakligen av den slags gas som används: inert vid MIG-svetsning (Metal Inert Gas), aktiv vid MAG-svetsning (Metal Active Gas).

- Koldioxid (CO₂)

Med CO₂ som skyddsgas erhåller man en hög inträngning med hög matningshastighet och goda mekaniska egenskaper till en låg driftskostnad. Nackdelen är att denna gas skapar betydande problem med fogarnas slutgiltiga kemiska sammansättning, eftersom element som lätt oxideras går förlorade, samtidigt som kolhalten i smältbadet ökar.

Svetsning med ren CO₂ medför även andra problem, såsom mycket stänk och bildande av koloxidporer.

- Argon

Denna inerta gas används ren vid svetsning av lätta legeringar. För svetsning i rostfritt stål med kromnickel är det bättre att arbeta med tillsats av 2 % syre och CO₂, vilket bidrar till att göra bågen stabil och svetssträngen bättre formad.

- Helium

Denna gas används som ett alternativ till argon. Den ger bättre inträngning (vid stora tjocklekar) och högre matningshastighet.

- Argon/heliumblandning

Ger en stabilare båge än ren helium samt bättre inträngning och hastighet än argon.

- Blandningar av Argon/CO₂ och Argon/CO₂/syre

Dessa blandningar används vid svetsning av järnhaltigt material, framför allt med SHORT-ARC som ökar värmeförseln. Detta utesluter inte användning med SPRAY-ARC.

Normalt innehåller blandningen en CO₂-andel på mellan 8% och 20% och O₂ på cirka 5%.





Se systemets instruktionsbok.

Unalloyed steel / High alloyed steel		Aluminum alloy	
Strömstyrkeintervall	Gasflöde	Strömstyrkeintervall	Gasflöde
3-50 A	10-12 l/min	3-50 A	10-12 l/min
30-100 A	10-14 l/min	30-100 A	10-15 l/min
75-150 A	12-16 l/min	75-150 A	12-18 l/min
150-250 A	14-18 l/min	150-250 A	14-22 l/min
250-400 A	16-20 l/min	250-400 A	16-25 l/min
400-500 A	18-22 l/min	400-500 A	18-30 l/min

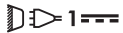

11. TEKNISKA DATA

Trådmatningsenhetens egenskaper WF NX 430 SteelDrive		U.M.
Typ av kuggväxelmotor	SL4R-4T	
Kuggväxelmotorns effekt	120	W
Antal valsar	4	
Tråddiameter / Standardrulle	1.0-1.2	mm
Möjlig tråddiameter / Lätthanterliga rullar	Trådmatningshastigheten 0.8-1.6 aluminiumtråd 1.2-2.4 rörtråd	mm/Material
Knapp för tömning av gasledning	ja	
Knapp för trådmatning	ja	
Wire tryck bakåt knapp	nej	
Tråd hastighet	25 Ø 0.8 - 1.0	m/min
Synergier	ja	
Externa enheter	ja (valfria)	
Uttag brännare Push-Pull-brännare	ja (valfria)	
Rullens diameter	200/300	mm
Framhjulens diameter	63/125 (optional)	mm
Bakhjulens diameter	63/125 (optional)	mm
Elektriska egenskaper WF NX 430 SteelDrive		U.M.
Nätspänning U1	48	Vdc
Kommunikationsbuss	DIGITAL	
Maximal strömförbrukning I1max	4.5	A
Utnyttjningsfaktor WF NX 430 SteelDrive		U.M.
Utnyttjningsfaktor (40°C)		
(X=50%)	500	A
(X=60%)	470	A
(X=100%)	420	A
Utnyttjningsfaktor (25°C)		
(X=80%)	500	A
(X=100%)	470	A
Fysiska egenskaper WF NX 430 SteelDrive		U.M.
IP-skyddsgrad	IP23S	
Mått (lxbxh)	640x250x460	mm
Vikt	19.0	Kg
Konstruktionsbestämmelser	EN IEC 60974-5:2019 EN 60974-10/A1:2015	

12. MÄRKPLÅT

 VOESTALPINE BÖHLER WELDING SELCO S.R.L. Via Palladio, 19 - ONARA (PADOVA) - ITALY			
WF NX 430		N°	
EN 60974-5:2019 IEC 60974-10/A1:2015 Class A			
	X (40°C)	60%	100%
	I ₂	500A	400A
 1	U ₁ 48V	I _{1max} 4.5A	
IP 23 S		UK CA  	
MADE IN ITALY 			

13. MÄRKPLÅTENS INNEBÖRD

1		2	
3		4	
5			
	6	6A	6B
	7	7A	7B
8	9	10	
11		UK CA  	
MADE IN ITALY 			

- 1 Fabrikat
- 2 Tillverkarens namn och adress
- 3 Apparatens modell
- 4 Serienummer
- 5 XXXXXXXXXXXXXX Tillverkningsår
- 5 Hänvisning till tillverkningsstandarder
- 6 Symbol för intermittenscykel
- 7 Symbol för nominell svetsström
- 6A Värdet för intermittenscykel
- 6B Värdet för intermittenscykel
- 7A Värdet för nominell svetsström
- 7B Värdet för nominell svetsström
- 8 Symbol för nätanslutning
- 9 Nominell matningsspänning
- 10 Max. nominell matningsström
- 11 Kapslingsklass

CE EU-försäkran om överensstämmelse
 EAC EAC-försäkran om överensstämmelse
 UKCA UKCA-försäkran om överensstämmelse

SV

EU-OVERENSSTEMMELSESERKLÆRING

Byggeren

voestalpine Böhler Welding Selco S.r.l. - Via Palladio, 19 - 35019 Onara di Tombolo (PD) - ITALY
Tel. +39 049 9413/111 - Fax +39 049 9413/311 - www.voestalpine.com/welding

erklærer under eget ansvar, at det følgende produkt:

WF NX 430 STEELDRIVE 71.01.083

er i overensstemmelse med følgende EU-direktiver:

2014/35/EU LOW VOLTAGE DIRECTIVE

2014/30/EU EMC DIRECTIVE

2011/65/EU RoHS DIRECTIVE

og at følgende harmoniserede standarder er anvendt:

EN IEC 60974-5:2019 WIRE FEEDERS

EN 60974-10/A1:2015 ELECTROMAGNETIC COMPATIBILITY REQUIREMENTS

Dokumentationen, der bekræfter overholdelse af direktiverne, holdes tilgængelig til inspektion hos den førnævnte producent.

Ethvert indgreb eller enhver ændring, der ikke er autoriseret af voestalpine Böhler Welding Selco S.r.l., vil medføre, at denne erklæring ikke længere er gyldig.

Onara di Tombolo, 03/07/2023

voestalpine Böhler Welding Selco s.r.l.

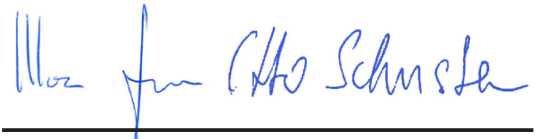

Mirco Frasson

Otto Schuster

Managing Directors

INDHOLDSFORTEGNELSE

1. ADVARSEL	309
1.1 Brugsomgivelser	309
1.2 Personlig beskyttelse og beskyttelse af andre	309
1.3 Beskyttelse mod røg og gas	310
1.4 Forebyggelse af brand/eksplosion	310
1.5 Forholdsregler ved brug af gasflasker	311
1.6 Beskyttelse mod elektrisk stød	311
1.7 Elektromagnetiske felter og forstyrrelser	311
1.8 IP-beskyttelsesgrad	312
1.9 Bortskaffelse.....	312
2. INSTALLERING	312
2.1 Løfte-, transport- og aflæsningsanvisninger.....	312
2.2 Placering af anlægget.....	313
2.3 Tilslutning	313
2.4 Idriftsættelse.....	313
3. PRÆSENTATION AF ANLÆGGET	315
3.1 Bagpanel	315
3.2 Stikkontaktpanel.....	315
3.3 Frontbetjeningspanel	316
4. UDSTYR BRUG	317
4.1 Startskærm	317
4.2 Testskærbillede.....	317
4.3 Hovedskærmen.....	317
5. SETUP.....	321
5.1 Set-up og indstilling af parametrene.....	321
5.2 Specifikke procedurer for brug af parametrene	330
6. EKSTRAUDSTYR	333
7. VEDLIGEHOLDELSE	334
7.1 Regelmæssig kontrol af strømkilden.....	334
7.2 Ответственность	334
8. ALARMKODER	334
9. FEJLFINDING OG LØSNINGER	336
10. BETJENINGSVEJLEDNING	338
10.1 Svejsning med kontinuerlig tråd (MIG/MAG)	338
11. TEKNISKE SPECIFIKATIONER	343
12. DATASKILT	344
13. BETYDNING AF OPLYSNINGERNE DATASKILT	344
14. OVERSIGT	459
15. KONNEKTORER.....	460
16. RESERVEDELSLISTE.....	461
17. INSTALLERING KIT/EKSTRAUDSTYR.....	464

SYMBOLER



Overhængende fare, der kan medføre alvorlige legemsbeskadigelser, samt farlige handlemåder, der kan forårsage alvorlige læsioner.



Handlemåder, der kan medføre mindre alvorlige legemsbeskadigelser eller beskadigelse af ting.



Bemærkninger med dette symbol foran er af teknisk karakter og gør indgrebene lettere at udføre.

1. ADVARSEL



Inden der udføres nogen form for indgreb, skal man have læst og forstået denne vejledning.

Der må ikke udføres ændringer på maskinen eller vedligeholdelse, der ikke er beskrevet i vejledningen. Fabrikanten påtager sig intet ansvar for legemsbeskadigelser eller beskadigelse af ting, opstået på grund af manglende læsning eller udførelse af indholdet i denne vejledning.

Opbevar altid brugsanvisningerne på apparatets brugssted. Overhold ikke blot brugsanvisningerne, men også de generelle forskrifter og de gældende lokale regler for forebyggelse af ulykker og miljøhensyn.



Alle personer med ansvar for ibrugtagning, for brug, for vedligeholdelse og for reparation af apparatetskal

- besidde den relevante kvalifikation
- have de nødvendige kompetencer med hensyn til svejsning
- læse hele denne brugsvejledning og nøje følge anvisningerne.

Tag kontakt til en fagmand i tilfælde af tvivl eller problemer omkring anlæggets brug, også selvom problemet ikke omtales heri.

1.1 Brugsomgivelser



Ethvert anlæg må udelukkende benyttes til dets forudsete brug, på de måder og områder, der er anført på dataskiltet og/eller i denne vejledning, og i henhold til de nationale og internationale sikkerhedsforskrifter. Anden brug end den, fabrikanten udtrykkeligt har angivet, skal betragtes som u hensigtsmæssig og farlig og vil fritage fabrikanten for enhver form for ansvar for skade.



Dette apparat må udelukkende anvendes til professionelle formål i industrielle omgivelser. Fabrikanten fralægger sig ethvert ansvar for skader forårsaget af anlæggets brug i private omgivelser.



Anlægget skal anvendes i omgivelser med en temperatur på mellem -10°C og +40°C (mellem +14°F og +104°F).

Anlægget skal transporteres og opbevares i omgivelser med en temperatur på mellem -25°C og +55°C (mellem -13°F og 131°F).

Anlægget skal benyttes i omgivelser uden støv, syre, gas eller andre ætsende stoffer.

Anlægget skal benyttes i omgivelser med en relativ luftfugtighed på højst 50% a 40°C (104°F).

Anlægget skal benyttes i omgivelser med en relativ luftfugtighed på højst 90% ved 20°C (68°F).

Anlægget må ikke benyttes i en højde over havet på over 2000m (6500 fod).



Anvend ikke apparatet til optøning af rør.

Benyt aldrig dette apparatur til opladning af batterier og/eller akkumulatorer.

Benyt aldrig dette apparatur til start af motorer.

1.2 Personlig beskyttelse og beskyttelse af andre



Svejsprocessen er kilde til skadelig stråling, støj, varme og gasudsendelse. Anbring en brandsikker afskærmning for at beskytte omgivelserne svejsmiljø mod stråler, gnister og glødende affald. Advar andre tilstedeværende om, at de ikke må rette blikket direkte mod svejsningen, og at de skal beskytte sig imod buens stråler eller glødende metalstykker.



Bær beskyttelsestøj til beskyttelse af huden mod lysbuestrålerne, gnister eller glødende metal. Den benyttede beklædning skal dække hele kroppen og være:

- intakt og i god stand
- brandsikker
- isolerende og tør
- tætsiddende og uden opslag



Benyt altid godkendt og slidstærkt sikkerhedsfodtøj, der er i stand til at sikre isolering mod vand.

Benyt altid godkendte sikkerhedshandsker, der yder en elektrisk og termisk isolering.



Anvend masker med sideskærme for ansigtet og egnet beskyttelsesfilter (mindst NR10 eller højere) for øjnene.



Benyt altid beskyttelsesbriller med sideafskærmning, især ved manuel eller mekanisk fjernelse af svejse-affaldet.



Bær aldrig kontaktlinser!



Benyt høreværn, hvis svejsprocessen når op på farlige støjniveauer. Hvis støjniveauet overskrider de grænser, der er fastlagt i lovgivningen, skal man afgrænse arbejdsområdet og sørge for, at de personer der har adgang, er beskyttet med høreværn.



Hold altid sidepanelerne lukkede under svejsearbejdet. Der må aldrig udføres nogen form for ændringer på anlægget. Undgå at hænder, hår, beklædning, værktøj... kommer i berøring med bevægelige dele så som: ventilatorer, tandhjul, valser og aksler, trådspoler. Rør aldrig ved tandhjulene, mens trådfremføringsenheden er i funktion. Omgåelse af beskyttelsesanordningerne på trådfremføringsenheden er ekstremt farlig og fritager fabrikanten for ethvert ansvar for skader på personer eller genstande.



Hold hovedet på lang afstand af MIG/MAG-brænderen under trådens isætning og fremføring. Tråden i udgang kan forårsage alvorlige skader på hænder, ansigt og øjne.



Undgå berøring af emner, der lige er blevet svejset. Varmen vil kunne forårsage alvorlige skoldninger eller forbrændinger. Overhold alle ovenfor beskrevne forholdsregler, også under bearbejdnings efter svejsningen, da svejseaffald kan falde af de bearbejdede emner, der er ved at køle af.



Kontrollér, at brænderen er kølet af, inden der udføres bearbejdnings eller vedligeholdelse.



Kontrollér, at kølegruppen er slukket, inden kølevæskens tilførsels- og afledningslanger kobles fra. Den varme væske, der løber ud af rørene, vil kunne forårsage alvorlige skoldninger eller forbrændinger.



Sørg for, at der er førstehjælpsudstyr til rådighed. Undervurder aldrig forbrændinger og sår.



Genopret sikre forhold i området, inden arbejdsområdet forlades, således at utilsigtet skade på personer og genstande undgås.

1.3 Beskyttelse mod røg og gas



Røg, gas og støv fra svejse-arbejdet kan medføre sundhedsfare. Røgen, der produceres under svejseprocessen, kan under visse forhold forårsage cancer eller fosterskade.

- Hold hovedet på lang afstand af svejsningens gas og røg.
- Sørg for ordentlig naturlig eller mekanisk udluftning i arbejdsområdet.
- Benyt svejsemasker med udsugning, hvis lokalets ventilation er utilstrækkelig.
- Ved svejsning i snævre omgivelser anbefales det, at der er en kollega til stede udenfor området til overvågning af den medarbejder, der udfører selve svejsningen.
- Anvend aldrig ilt til udluftning.
- Undersøg udsugningens effektivitet ved, med jævne mellemrum, at sammenholde emissionsmængden af giftig gas med de tilladte værdier i sikkerhedsforskrifterne.
- Mængden og farligheden af den producerede røg kan tilbageføres til det anvendte basismateriale, til det tilførte materiale samt til eventuelt anvendte rengøringsmidler eller affedningsmidler på det emne, der skal svejdes. Følg omhyggeligt fabrikantens anvisninger og de relevante tekniske datablade.
- Udfør aldrig svejsning i nærheden af områder, hvor der foretages affedning eller maling.
- Placer gasflaskerne udendørs eller på steder med korrekt luftcirkulation.

1.4 Forebyggelse af brand/eksplosion



Svejse-processen kan være årsag til brand og/eller eksplosion.

- Fjern antændelige eller brændbare materialer eller genstande fra arbejdsområdet og det omkringliggende område.
- Brændbare materialer skal befinde sig mindst 11 meter fra svejseområdet og skal beskyttes på passende vis.
- Gnister og glødende partikler kan nemt blive spredt vidt omkring og nå de omkringliggende områder, også gennem små åbninger. Udvis særlig opmærksomhed omkring sikring af personer og genstande.
- Udfør aldrig svejsning oven over eller i nærheden af beholdere under tryk.
- Udfør aldrig svejsning på lukkede beholdere eller rør. Udfør aldrig svejsning eller skæring på lukkede beholdere eller rør. Udvis særlig opmærksomhed under svejsning af rør eller beholdere, også selv om de er åbne, tomme og omhyggeligt rengjorte. Rester af gas, brændstof, olie og lignende kan forårsage eksplosioner.
- Udfør aldrig svejse-arbejde i en atmosfære med eksplosionsfarlige pulvermaterialer, gasser eller dampe.
- Kontrollér efter afsluttet svejsning, at kredsløbet under spænding ikke utilsigtet kan komme i berøring med elementer, der er forbundet til jordforbindelseskredsløbet.
- Sørg for, at der er brandslukningsudstyr til rådighed i nærheden af arbejdsområdet.

1.5 Forholdsregler ved brug af gasflasker



Gasflasker med inaktiv gas indeholder gas under tryk og kan eksplodere hvis transport-, opbevarings- og brugsforholdene ikke sikres efter forskrifterne.

- Gasflaskerne skal fastspændes opretstående på en væg eller lignende med egnede midler, så de ikke kan vælte eller støde sammen.
- Skru beskyttelseshætten på ventilen under transport, klargøring, og hver gang svejsearbejdet er fuldført.
- Undgå at gasflaskerne udsættes for direkte solstråler, pludselige temperaturudsving, for høje eller for lave temperaturer. Udsæt aldrig gasflaskerne for meget lave eller høje temperaturer.
- Undgå omhyggeligt, at gasflaskerne kommer i berøring med åben ild, elektriske buer, brændere, elektrodeholdertænger eller med glødende partikler fra svejsningen.
- Hold gasflaskerne på lang afstand af svejsekredsløb og strømkredsløb i almindelighed.
- Hold hovedet på lang afstand af det punkt, hvorfra gassen strømmer ud, når der åbnes for gasflaskens ventil.
- Luk altid for gasflaskens ventil, når svejsningen er fuldført.
- Udfør aldrig svejsning på en gasflaske under tryk.
- Tilslut aldrig en tryklufthflaske direkte til maskinens trykregulator! Trykket kan overskride trykregulatorens kapacitet, således at der opstår fare for eksplosion!

1.6 Beskyttelse mod elektrisk stød



Et elektrisk stød kan være dødbringende.

- Undgå berøring af strømførende dele både inden i og uden på svejseægget, så længe anlægget er under forsyning (brændere, tænger, jordforbindelseskabler, elektroder, ledninger, valser og spoler er elektrisk forbundet til svejsekredsløbet).
- Sørg for, at anlæg og elektrisk isoleret ved hjælp af tørre plader og sokler med tilstrækkelig isolering mod mulig jordforbindelse.
- Kontrollér, at anlægget er forbundet korrekt til et stik og en strømkilde udstyret med en jordledning.
- Berør aldrig to svejsebrændere eller to elektrodeholdertænger samtidigt.
- Afbryd øjeblikkeligt svejse-arbejdet, hvis det føles, som om der modtages elektrisk stød.

1.7 Elektromagnetiske felter og forstyrrelser



Passagen af strøm igennem anlæggets indvendige og udvendige kabler skaber et elektromagnetisk felt i umiddelbar nærhed af svejsekablerne og af selve anlægget.

- Elektromagnetiske felter kan forårsage (på nuværende tidspunkt ukendte) helbredseffekter ved længerevarende påvirkning.
- De elektromagnetiske felter kan påvirke andet apparatur så som pacemakere eller høreapparater.



Bærere af vitale elektroniske apparater (pacemaker) bør konsultere en læge, inden de kommer i nærheden af lysbuesvejsninger.

1.7.1 Klassificering EMC i overensstemmelse med: EN 60974-10/A1:2015.

Klasse
B

Udstyr i klasse B overholder kravene vedrørende elektromagnetisk kompatibilitet i industrielle miljøer og private boliger, herunder boligområder, hvor elektriciteten leveres via det offentlige lavspændingsforsyningsnet.

Klasse
A

Udstyr i klasse A er ikke beregnet til brug i boligområder, hvor elektriciteten leveres via det offentlige lavspændingsforsyningsnet. Der kan være visse vanskeligheder med at sikre elektromagnetisk kompatibilitet for klasse-A-udstyr i sådanne områder på grund af ledningsbårne forstyrrelser og strålingsforstyrrelser.

For mere information, se kapitlet: DATASKILT eller TEKNISKE SPECIFIKATIONER.

1.7.2 Installering, brug og vurdering af området

Dette apparat er bygget i overensstemmelse med kravene i den harmoniserede standard EN 60974-10/A1:2015 og er identificeret som et "KLASSE A"-apparat. Dette apparat må udelukkende anvendes til professionelle formål i industrielle omgivelser. Fabrikanten fralægger sig ethvert ansvar for skader forårsaget af anlæggets brug i private omgivelser.



Brugeren skal have ekspertise indenfor arbejdsområdet, og han/hun er i denne henseende ansvarlig for installering og brug af apparatet i overensstemmelse med fabrikantens anvisninger. Hvis der opstår elektromagnetiske forstyrrelser, er det brugerens opgave at løse problemet med hjælp fra fabrikantens tekniske servicetjeneste.



Elektromagnetiske forstyrrelser skal under alle omstændigheder reduceres i en sådan grad, at de ikke længere har nogen indflydelse.



Inden dette apparat installeres, skal brugeren vurdere de eventuelle elektromagnetiske problemer, der kan opstå i det omkringliggende område, specielt hvad angår de tilstedeværende personers sundhedstilstand, fx: brugere af pacemakere og høreapparater.

1.7.3 Forholdsregler vedrørende ledningerne

Følg nedenstående regler for at reducere virkningen af de elektromagnetiske felter:

- Rul, om muligt, jordforbindelses- og effektkablerne op og fastspænd dem.
- Undgå at vikke svejsekablet rundt om kroppen.
- Undgå at stå imellem jordforbindeskablet og effektkablet (hold begge kabler på samme side).
- Kablerne skal holdes så korte som muligt, og de skal placeres så tæt sammen som muligt og føres nær eller på gulvplanet.
- Placer anlægget i en vis afstand af svejseområdet.
- Kablerne skal holdes adskilt fra alle øvrige kabler.

1.7.4 Potentialudligning

Der skal tages højde for stelforbindelse af alle metalkomponenter på svejse-anlægget og i den umiddelbare nærhed. Overhold den nationale lovgivning vedrørende potentialudligning.

1.7.5 Jordforbindelse af arbejdsområdet

Hvis arbejdsområdet ikke er jordforbundet af hensyn til den elektriske sikkerhed eller p.g.a. dets størrelse og placering, kan en stelforbindelse mellem området og jorden reducere udsendelserne. Vær opmærksom på, at jordforbindelsen af arbejdsområdet ikke må øge risikoen for arbejdsulykker for brugerne eller beskadige andre elektriske apparater. Overhold den nationale lovgivning vedrørende jordforbindelse.

1.7.6 Afskærmning

Afskærmning af udvalgte kabler og apparater i det omkringliggende område kan løse interferensproblemer. Muligheden for afskærmning af hele svejse-anlægget kan overvejes i specielle arbejdsituationer.

1.8 IP-beskyttelsesgrad



IP23S

- Indkapslingen er beskyttet mod indføring af fingre og faste fremmedlegemer med en diameter større end/lig med 12,5 mm og berøring af farlige dele.
- Indkapslingen er beskyttet mod regn i en vinkel på op til 60° fra lodret position.
- Indkapslingen er beskyttet mod skader forårsaget af vandindtrængning, når apparaturets bevægelige dele ikke er i bevægelse.

1.9 Bortskaffelse



Apparatet må ikke bortskaffes med normalt affald.

I overensstemmelse med det europæiske direktiv 2012/19/EU om affald af elektrisk og elektronisk udstyr og dets implementering i overensstemmelse med national lovgivning skal elektrisk udstyr, der er udtjent, indsamles separat og sendes til nyttiggørelse og bortskaffelse. Ejeren af udstyret skal identificere de autoriserede indsamlingscentre ved at forhøre sig hos kommunen. Anvendelsen af det europæiske direktiv vil forbedre miljøet og menneskers sundhed.

» Se hjemmesiden for yderligere oplysninger.

2. INSTALLERING



Installeringen må kun udføres af erfarent personale, der godkendes af svejsemaskinens fabrikant.



Ved installering skal man sørge for, at strømkilden er afbrudt fra forsyningsnettet.

2.1 Løfte-, transport- og aflæsningsanvisninger

- Anlægget er udstyret med et greb, der giver mulighed for at transportere det i hånden.
- Anlægget er ikke udstyret med specielle løfteelementer.
- Benyt en gaffellift og udvis stor forsigtighed under flytninger, for at undgå at generatoren vælter.



Undervurder aldrig anlæggets vægt, (læs de tekniske specifikationer).

Lad aldrig læsset glide hen over - eller hænge stille over - mennesker eller ting.

Lad aldrig anlægget eller de enkelte enheder falde eller støtte mod jordoverfladen med stor kraft.

2.2 Placering af anlægget



Overhold nedenstående forholdsregler:

- Der skal være nem adgang til betjeningsorganerne og tilslutningspunkterne.
- Placér aldrig udstyret i snævre områder.
- Anbring aldrig anlægget på en overflade med en hældning på over 10° i forhold til det vandrette plan.
- Slut anlægget til i et tørt, rent område med god udluftning.
- Beskyt anlægget mod direkte regn og solstråler.

2.3 Tilslutning





De mobile enheder fra forsynes udelukkende med lav spænding.

2.4 Idriftsættelse

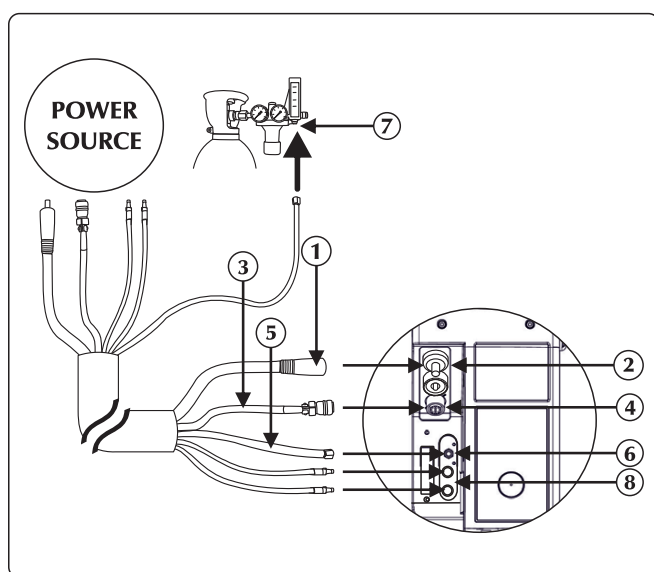
2.4.1 Tilslutning til MIG/MAG-svejsning



- ① Effektkabel
- ② Positivt effektudtag (+)
- ③ Signalkabel
- ④ Signalkabelindgang
- ⑤ Gasrør
- ⑥ Samlestykke/kobling gas
- ⑦ Samlestykke til gastilførsel
- ⑧ Tilslutning kølevæske

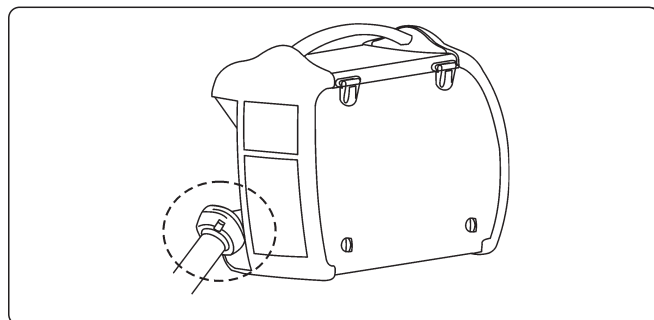

- ▶ Forbind kabelbundtets effektkabel til det relevante udtag. Sæt stikket i og drej med uret, indtil elementerne er skruet fuldstændigt fast.
- ▶ Forbind kabelbundtets signalkabel til den relevante konnektor. Sæt forbindelsesleddet i og drej ringmøtrikken med uret, indtil delene sidder helt fast.
- ▶ Forbind kabelbundtets gasslange til gasflaskens trykregulering eller til samlestykket på gasforsyningen. Indstil gasstrømningen på mellem 10 og 30 l/min.
- ▶ Forbind kabelbundtets kølevæsketilførselsslange (blå farve) med det relevante samlestykke/kobling (blå farve - symbol ).
- ▶ Forbind kabelbundtets kølevæsketilbageførselsslange (rød farve) med det relevante samlestykke/kobling (rød farve - symbol .
- ▶ Forbind CAN-BUS signalkablet, som styrer eksternt udstyr (fx RC, RI...) til forbindelsesleddet.

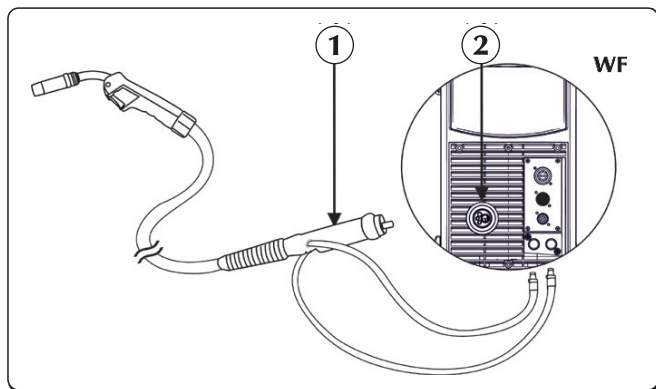

Se afsnittet "Installation tilbehør".



- ① Brændertilslutning
- ② Konnektor

- ▶ Forbind brænderens kølevæsketilbageløbsslange (rød farve) med det relevante samlestykke/kobling (rød farve - symbol ).
- ▶ Forbind brænderens kølevæsketilførselsslange (blå farve) med det relevante samlestykke/kobling (blå farve - symbol ).
- ▶ Forbind MIG/MAG-brænderen til adapteren. Vær specielt påpasselig med at stramme fastgøringsringen fuldstændigt.

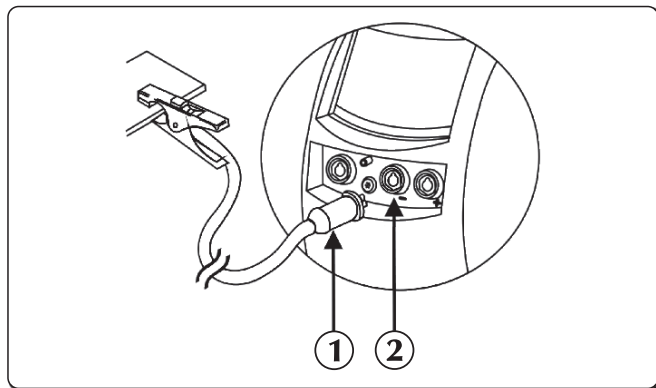

- ① Stik til jordforbindelsestang
- ② Negativt effektudtag (-)

- ▶ Tilslut jordklemmen til den negative pol (-) på strømforsyningen. Sæt stikket i og drej med uret, indtil elementerne er skruet fuldstændigt fast.

Motorrum

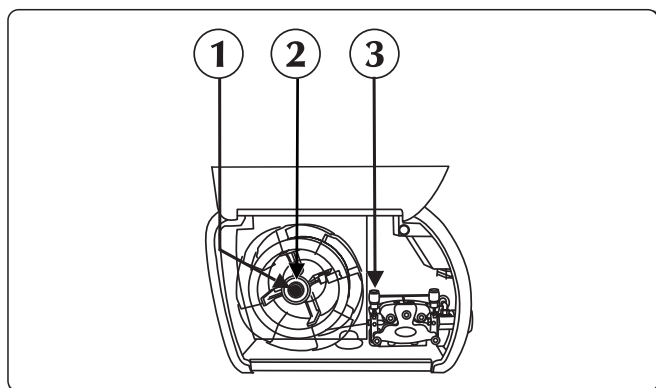

- ① Ringmøtrikken
- ② Friktionsskruen
- ③ Gearmotorens fremføringsstøtte

- ▶ Åbn højre sideafskærmning.
- ▶ Kontrollér, at den lille rullers fordybning stemmer overens med diameteren på den tråd, man ønsker at anvende.
- ▶ Skru ringmøtrikken af spoleholderhaspen, og indsæt spolen.
- ▶ Sæt derefter også spoleholderens tap på plads i sædet, sæt spolen i, anbring igen ringmøtrikken i positionen og juster friktionsskruen.
- ▶ Frigiv gearmotorens fremføringsstøtte og indsæt trådenden i trådlederens bøsning, hvorefter den skal passere på den lille rulle og frem til brændertilslutningen. Blokér fremføringsstøtten i korrekt position, og kontrollér, at tråden går ind i de små rullers fordybning.
- ▶ Tryk på knappen trådfremføring for at føre tråden frem i brænderen.
- ▶ Indstil gasstrømningen på mellem 10 og 30 l/min.

3. PRÆSENTATION AF ANLÆGGET

3.1 Bagpanel

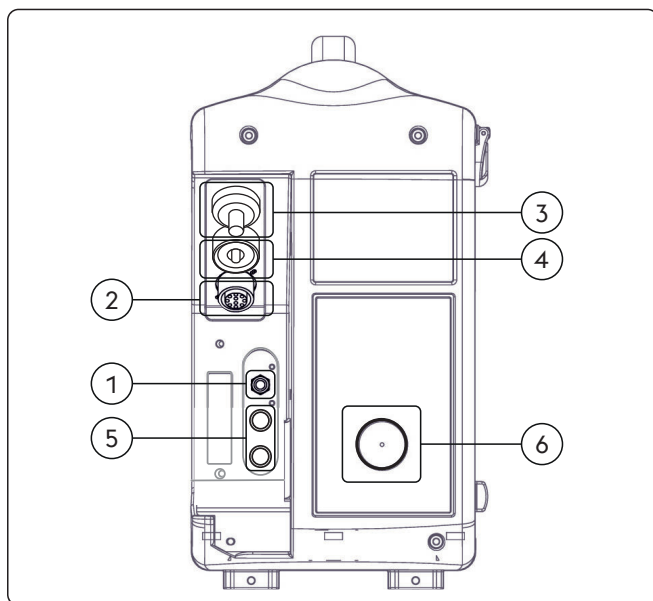

- ① Gastilslutning
- ② Indgang signalkabel (CAN-BUS) (kabelbundet)
- ③ Indgang effektkabel (kabelbundet)
- ④ Positivt effektudtag (+)
- ⑤ Indgang/udgang kølevæske.
- ⑥ Trådindgang

3.2 Stikkontaktpanel

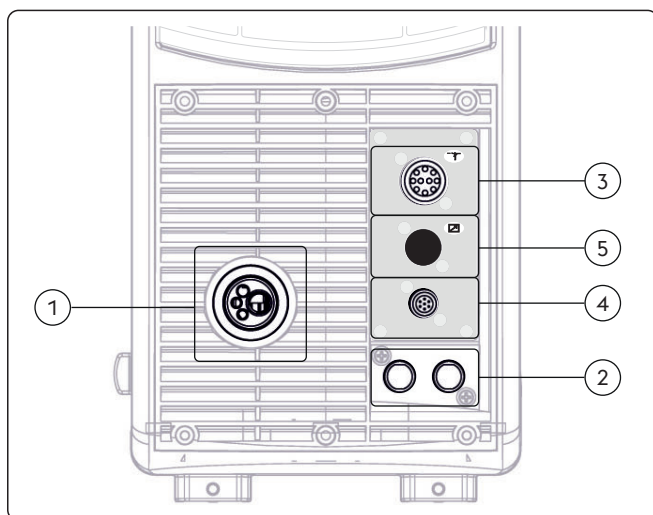

- ① Brændertilslutning
Giver mulighed for at slutte MIG/MAG-brænderen til.
- ② Tilslutning kølevæske
- ③ Signalkabelindgang (Push-Pull)
- ④ Indgang signalkabel (brænder)
Tilslutning af brænder
- ⑤ Signalkabel (RC) input

3.3 Frontbetjeningspanel

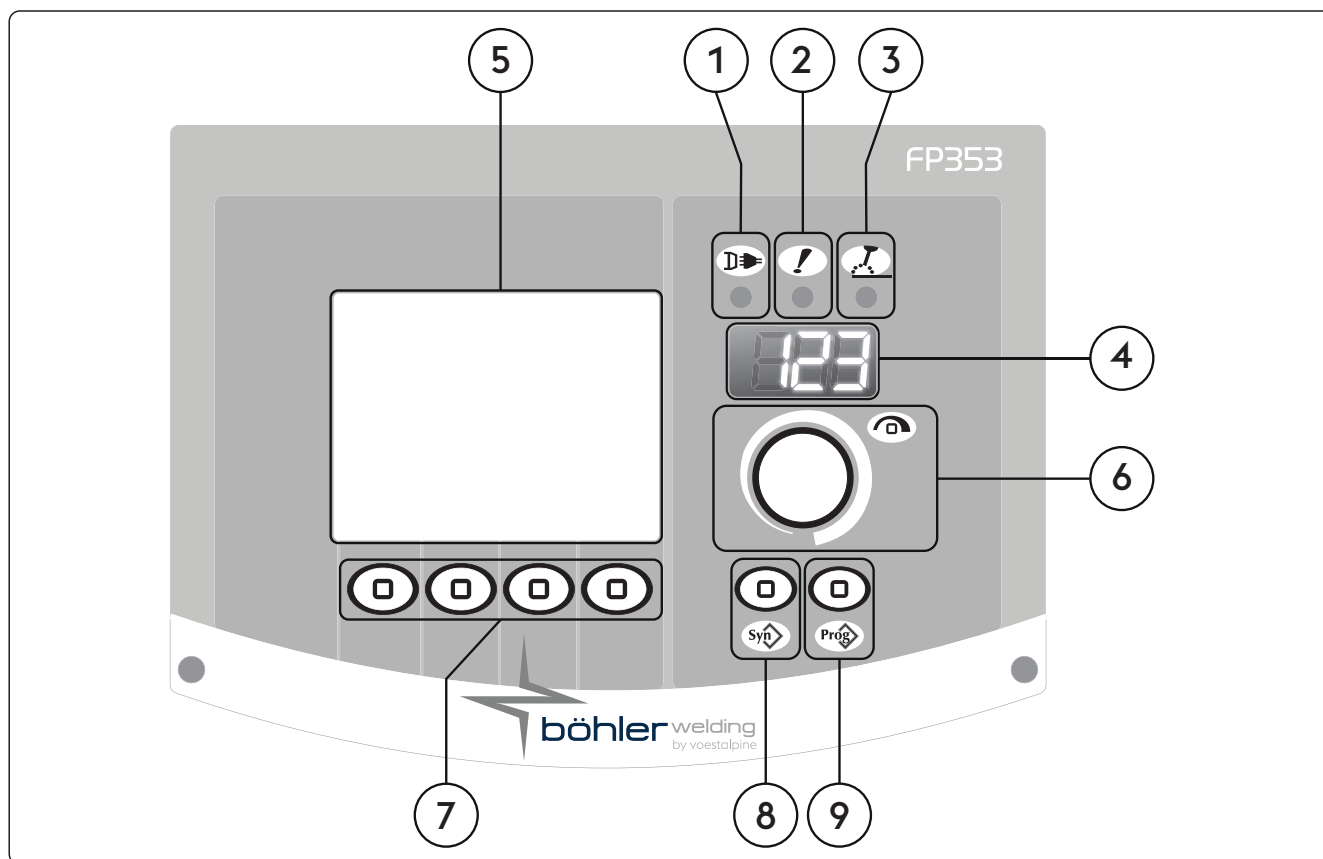

- 1 **LED for strømforsyning**
Angiver, at anlægget er tilsluttet forsyningsnettet og tændt.
- 2 **LED for generel alarm**
Angiver, at beskyttelsesanordninger, som f.eks. temperaturbeskyttelsen, kan aktiveres.
- 3 **LED for aktiv effekt**
Angiver, at der er spænding på anlæggets udgangsforbindelser.
- 4 **7-segment display**
Gør det muligt at vise svejsemaskinens generelle parametre under opstart, indstillinger, strøm- og spændingsaflysninger, under svejsning og indkodning af alarmer.
- 5 **LCD-display**
Gør det muligt at vise svejsemaskinens generelle parametre under opstart, indstillinger, strøm- og spændingsaflysninger, under svejsning og indkodning af alarmer.
Alle aktiviteter kan vises samtidig.
- 6 **Reguleringshåndtag**
Giver mulighed for indtastning af valg og indstilling af svejseparametrene.
- 7 **Funktionsknapper**
Gør det muligt at vælge systemets forskellige funktioner:
- Svejsproces
- Svejsemetoder
- Strømpulsering
- Grafik-funktion

DA

8

Tasten svejseprogrammer

Gør det muligt at vælge et forud indstillet program ved at vælge nogle enkelte oplysninger:

- Type tråd
- Gastype
- Tråddiameter

9

Tasten job

4. UDSTYR BRUG

4.1 Startskærm

Når generatoren tændes, udfører den en række check for at sikre at såvel systemet som det tilsluttede udstyr fungerer, som de skal. Samtidig udføres gastesten for at checke, om forbindelsen til gastilførselssystemet er i orden.

4.2 Testskærmbillede

Når sidepanelet (spolerum) er åbent, hindres svejseoperationerne.

På displayet LCD fremkommer testskærmbilledet.

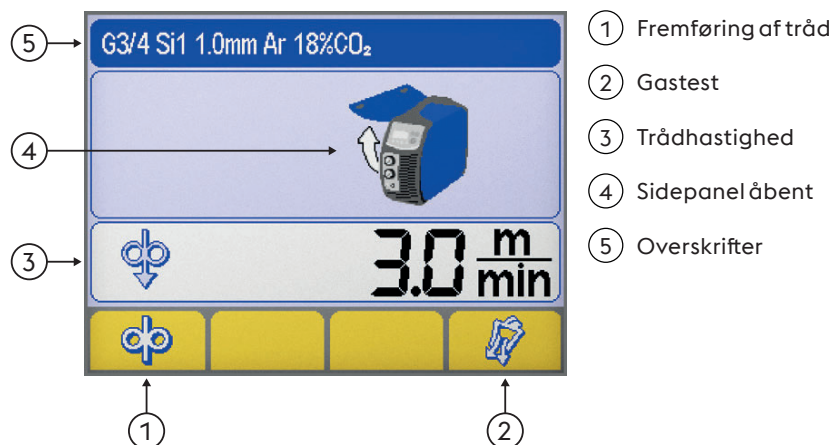
Fremføring af tråd

Giver mulighed for manuel trådfremføring uden gasstrømning og uden strøm på tråden. Giver mulighed for indsættelse af tråden i brænderens kappe under forberedelserne til svejsningen.

Gastest

Gør det muligt at rense gaskredsløbet for urenheder og, uden output-power, at foretage de indledende gastryk- og flowreguleringer.

Trådhastighed

Gør det muligt at regulere trådfremføringshastigheden (under påsætningstrinnet).

Minimum	Maksimum	Default
0.5 m/min	22.0 m/min	3.0 m/min

Sidepanel åbent

Overskrifter

Gør det muligt at se de vigtigste informationer om de valgte processer.

4.3 Hovedskærmen

Giver mulighed for at styre systemet og svejseprocessen, da den viser de væsentligste indstillinger.

DA

4.4 Hovedskærm-billede MIG/MAG proces

Basisskærm-billede

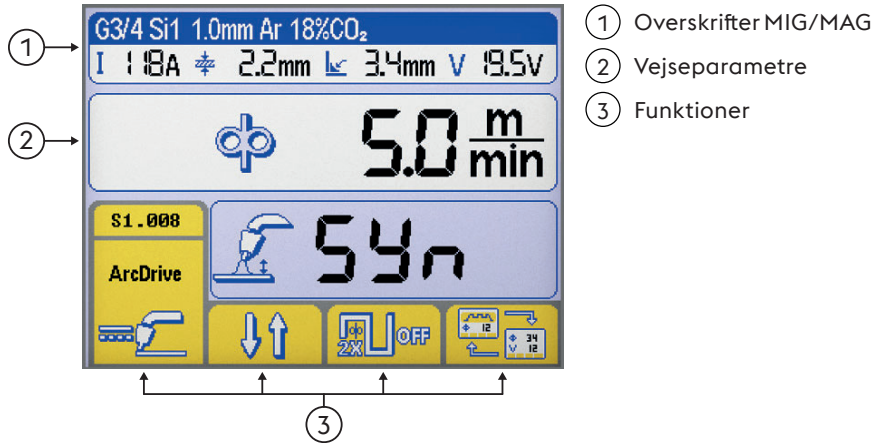

- ① Overskrifter MIG/MAG
- ② Vejseparametre
- ③ Funktioner

Grafisk skærm-billede

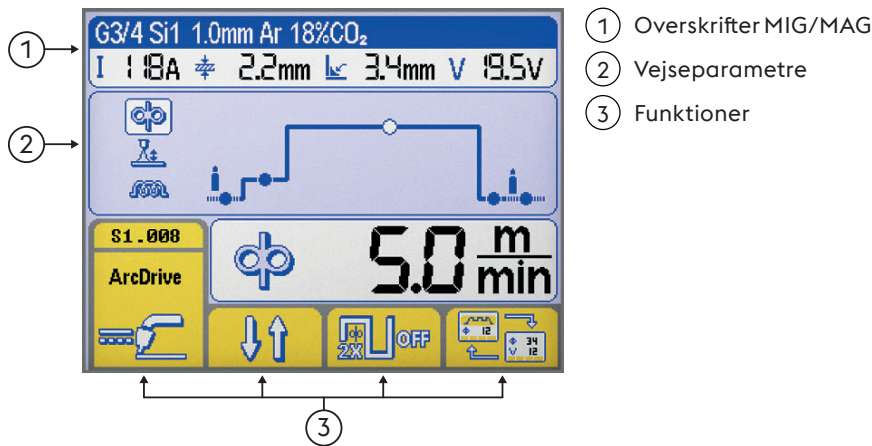

- ① Overskrifter MIG/MAG
- ② Vejseparametre
- ③ Funktioner

Overskrifter MIG/MAG

Gør det muligt at se de vigtigste informationer om de valgte processer.



- ① Tilsatstrådmateriale
- ② Tråddiameter
- ③ Gastype

Valgte synergikurve

- ① Tilsatstrådmateriale
- ② Tråddiameter
- ③ Gastype



- ① Svejsestrøm
- ② Arbejdsemnets tykkelse
- ③ Vinkelsvejsning "α"
- ④ Svejse-spænding

Vejseparametre

- ① Svejsestrøm
- ② Arbejdsemnets tykkelse
- ③ Vinkelsvejsning "α"
- ④ Svejse-spænding

Vejseparametre (Basisskærm-billede)

► Vælg de ønskede parametre ved at trykke på encoderknappen.

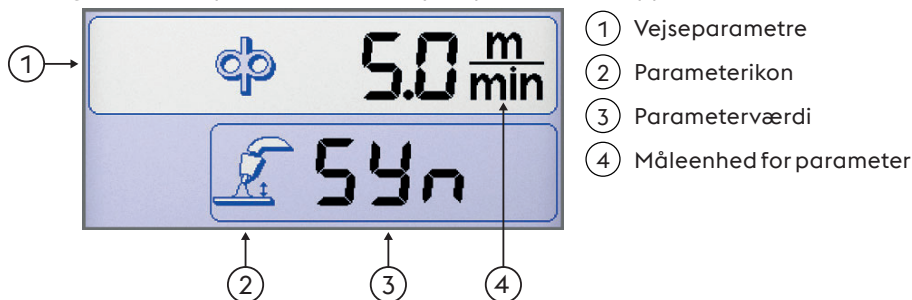

- ① Vejseparametre
- ② Parameterikon
- ③ Parameterværdi
- ④ Måleenhed for parameter

DA

Vejseparametre (Grafisk skærbillede)

► Vælg de ønskede parametre ved at trykke på encoderknappen.

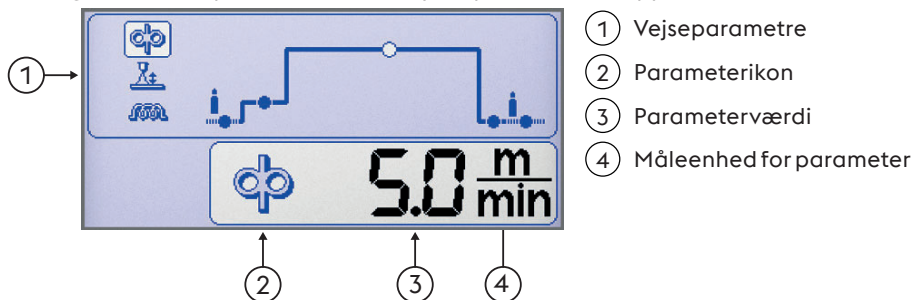

Funktioner

Gør det muligt at indstille de vigtigste procesfunktioner og svejsemetoder.

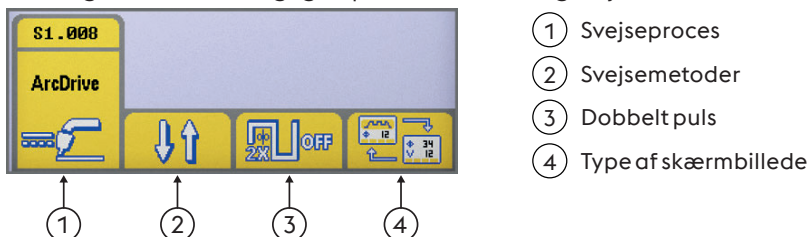

Svejsemetoder

Her kan vælges svejsemetode



2 taktr

Et tryk på knappen får gassen til at strømme, tråden tilføres spænding, og den føres frem; når knappen slippes, slukkes der for gassen, og i spændingen.



4 taktr

Det første tryk på knappen får gassen til at strømme med en manuel gasforstrømningstid. Når knappen slippes, aktiveres spændingen. Det efterfølgende tryk på knappen standser tråden og starter den endelige proces, som bringer strømmen tilbage til nul. Når knappen slippes til sidst, slukkes der for gasstrømmen.



Crater filler

Giver mulighed for svejsning med tre forskellige effekt niveauer, som svejseren kan vælge direkte og styre ved hjælp af brænderknappen.

Det første tryk på knappen får gassen til at strømme, aktiverer spændingen til tråden og fører den frem med den hastighed, der er indstillet med parameteren "initial increment" (under opsætningen) og med svejseparametrene relative synergiværdier.

Når brænderknappen slippes, ændres trådhastigheden og de relative synergiparametre automatisk til de hovedværdier, der er indstillet på kontrolpanelet.

Det næste tryk på brænderknappen bringer trådhastigheden og de relative synergiparametre op på de (under opsætningen) forudindstillede parameterværdier for kraterfylder.

Når brænderknappen slippes, standser trådfremføringen, og der leveres strøm til "burn-back" og gasefterstrømningstakterne.



Dobbelt puls



Dobbelt puls aktiv



Dobbelt puls ikke aktiv

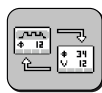

Type af skærbillede

Giver mulighed for ændring i visualisering mellem:



Basisskærbillede



Grafisk skærbillede

Synergikurveskærm

Synergi



Gør det muligt at vælge et forud indstillet program (synergi) ved at vælge nogle enkelte oplysninger

Valg af svejseproces

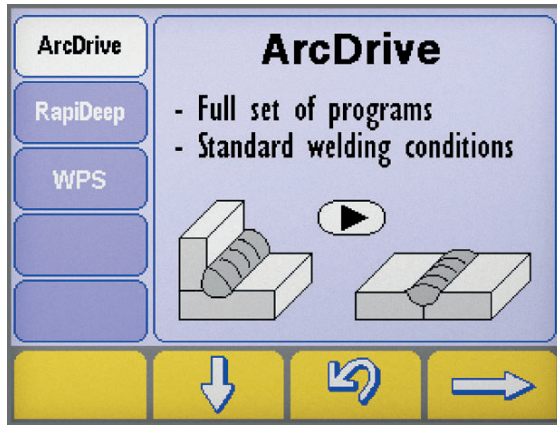

- ▶ Få adgang til skærbilledet "synergi" ved at trykke knappen i mindst et sekund.
- ▶ Vælg den ønskede proces ved at trykke knapperne e .
- ▶ Tryk på knappen for at gå videre til næste trin.



Skærbillede til valg af synergi materialetype/gastype

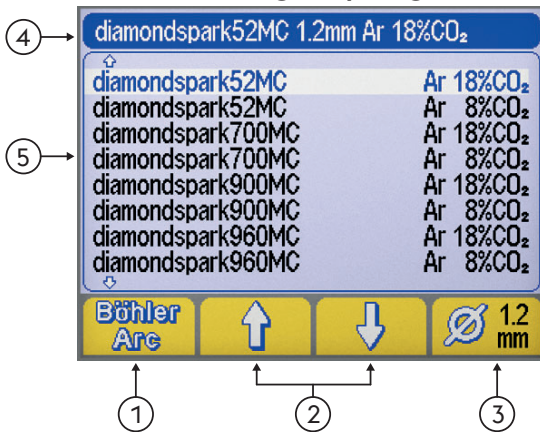

- ① Svejseprogram (BöhlerArc/UniversalArc)
- ② Valg af materiale/gas
- ③ Tråddiameter
- ④ Overskrifter
- ⑤ Svejseprogram



Svejseprogram

Her kan vælges svejseprogram



BöhlerArc



UniversalArc



Valg af materiale/gas

Tryk på sektionen:



- Tilsatstrådmateriale
- Gastype



Tråddiameter

Giver mulighed at vælge den anvendte tråddiameter (mm).



- ① Tråddiameter



DA

Overskrifter

Gør det muligt at se de vigtigste informationer om de valgte processer.

NO PROGRAM

Indikerer, at den valgte synergikurve ikke er tilgængelig eller ikke kan anvendes sammen med systemets øvrige indstillinger.

5. SETUP

5.1 Set-up og indstilling af parametrene

Giver mulighed for indstilling og regulering af en række ekstra parametre til en bedre og mere præcis administration af svejseanlægget.

Parametrene i setup er ordnet i henhold til den valgte svejseproces og har et kodenummer.

Adgang til setup





- ▶ Sker ved at trykke 5 sekunder på encoder-tasten.
- ▶ Indgangen bekræftes af angivelsen 0 på displayet.

Markering og indstilling af det ønskede parameter

- ▶ Opnås ved at dreje på indkodningstasten, indtil det ønskede parameters kodenummer vises.
- ▶ På dette tidspunkt giver et tryk på indkodningstasten mulighed for at få vist og regulere indstillingsværdien for det markerede parameter.

Udgang fra setup

- ▶ Tryk igen på indkodningstasten for at forlade "reguleringssektionen".
- ▶ Man forlader setup ved at gå til parameteret "0" (lagr og luk) og trykke på indkodningstasten.
- ▶ Godkend ved at trykke på knappen .
- ▶ Modifikationen gemmes og man forlader set up ved at trykke på tasten: .

5.1.1 Liste over parametrene i setup (MMA)

0 Lagr og luk



Giver mulighed for at lagre modifikationerne og forlade setup.

1 Reset



Giver mulighed for at indstille alle parametrene på defaultværdierne igen.

3 Hot start



Giver mulighed for at regulere hot-start-værdien i MMA.

Herved tillades en mere eller mindre "varm" start under buens tændingsfaser, hvilket reelt letter starthandlingerne.

Basisk elektrode

Minimum	Maksimum	Default
0/off	500%	80%

Cellulose elektrode

Minimum	Maksimum	Default
0/off	500%	150%

CrNi-elektrode

Minimum	Maksimum	Default
0/off	500%	100%

Aluminium elektrode

Minimum	Maksimum	Default
0/off	500%	120%

Støbejerns elektrode

Minimum	Maksimum	Default
0/off	500%	100%

7 Svejsestrøm



Giver mulighed for at regulere svejsestrømmen.

Minimum	Maksimum	Default
3 A	I _{max}	100 A

8 Arc force



Giver mulighed for at indstille værdien på Arc force i MMA.

Herved tillades en mere eller mindre energisk dynamisk respons under svejsning, hvilket reelt letter svejsehandlingerne.

Lysbuens styrkeværdi øges for at mindske risikoen for, at elektroden sidder fast.

Basisk elektrode

Minimum	Maksimum	Default
0/off	500%	30%

Cellulose elektrode

Minimum	Maksimum	Default
0/off	500%	350%

CrNi-elektrode

Minimum	Maksimum	Default
0/off	500%	30%

Aluminium elektrode

Minimum	Maksimum	Default
0/off	500%	100%

Støbejerns elektrode

Minimum	Maksimum	Default
0/off	500%	70%

204 Dynamic power control (DPC)



Gør det muligt at vælge det ønskede forhold mellem spænding og strøm.

I=C Konstant strøm

Forøgelse eller mindskelse af lysbuehøjden har ingen indvirkning på den krævede svejsestrøm.

Anbefales til elektrode: Basisk, Rutil, Sur, Stål, Støbejern

1:20 Karakteristik cadente con regolazione di rampa

Forøgelse af lysbuehøjden som følge af reduktion i svejsestrømmen (og vice versa) i henhold til den fastsatte værdi ved 1 til 20 ampere pr. volt.

Anbefales til elektrode: Cellulose, Aluminium

P=C Konstant spænding

Forøgelse af lysbuehøjden som følge af reduktion i svejsestrømmen (og vice versa) i henhold til formlen: $V \cdot I = K$

Anbefales til elektrode: Cellulose, Aluminium

312 Buens afbrydningspænding



Giver mulighed for at indstille den spændingsværdi, hvor den elektriske bue forceres til at slukke.

Det giver mulighed for bedre at administrere de forskellige driftsforhold, der opstår.

I punktsvejsningsfasen, for eksempel, vil buens lavere afbrydningspænding give mulighed for en mindre lue, når elektroden flyttes væk fra emnet, hvilket reducerer sprutten, brænding og oxidering af emnet.

Hvis der anvendes elektroder, der kræver en høj spænding, er det derimod tilrådeligt at indstille en høj tærskel for at undgå, at buen slukkes under svejsningen.



Indstil aldrig buens afbrydningspænding højere end strømkildens tomgangsspænding.

Basisk elektrode

Minimum	Maksimum	Default
0/off	99.9 V	57.0 V

Cellulose elektrode

Minimum	Maksimum	Default
0/off	99.9 V	70.0 V

399 Forskydningshastighed



Gør det muligt at indstille svejsningens udførelses hastighed.

Default cm/min: referencehastighed for håndsvejsning.

Syn: Sinergic værdi.

Minimum	Maksimum	Default
1 cm/min	200 cm/min	15 cm/min

500 Indstilling af maskine

Gør det muligt at vælge den ønskede grafiske interface.
Gør det muligt at få adgang til højere set up-niveauer.
Se under "Skræddersyet interface (Set up 500)"

Værdi	Brugerinterface	Værdi	Markeret niveau
XE	Tilstanden Easy	USER	Bruger
XA	Tilstanden Advanced	SERV	Service
XP	Tilstanden Professional	vaBW	vaBW

551 Lock/unlock

Gør det muligt at låse kontrolpanelets indstillinger og at installere en beskyttelseskode.
Se under "Lock/unlock (Set up 551)".

552 Summetone

Giver mulighed for at justere summetonen.

Minimum	Maksimum	Default
0/off	10	10

601 Reguleringstrin

Gør det muligt at regulere et parameter med trin, som man selv kan skræddersy

Minimum	Maksimum	Default
1	Imax	1

602 Ekstern parameter CH1, CH2, CH3, CH4

Gør det muligt at styre den eksterne parameter 1, 2, 3, 4 (minimumværdi, maksimumværdi, defaultværdi, valgte parameter).

Se under "Styring fra eksternt udstyr (Set up 602)".

705 Justering af kredsløbsmodstand

Tillader at kalibrere anlægget.

Se under "Justering af kredsløbsmodstand (set up 705)".

751 Strømaflæsning

Gør det muligt at se den faktiske værdi for svejsestrømmen.

752 Spændingsaflysning

Gør det muligt at aflæse den faktiske værdi for svejse-spænding.

768 Måling af tilført termisk energi HI

Tillader aflæsning af værdien på den tilførte termiske energi i svejsningen.

801 Stopgrænser

Gør det muligt at indstille advarselsværdier og stopværdier.

Gør det muligt at styre svejseprocessen ved at sætte advarselsgrenser og stopgrænser for de vigtigste målbare parametre.

Giver mulighed for nøje styring af de forskellige svejsefaser.

Se under "Stopgrænser (Set up 801)".

5.1.2 Liste over opsætningsparametre (TIG)
0 Lagr og luk

Giver mulighed for at lagre modifikationerne og forlade setup.

1 Reset



Giver mulighed for at indstille alle parametrene på defaultværdierne igen.

7 Svejsestrøm



Giver mulighed for at regulere svejsestrømmen.

Minimum	Maksimum	Default
3 A	I _{max}	100 A

399 Forskydningshastighed



Gør det muligt at indstille svejsningens udførelses hastighed.
 Default cm/min: referencehastighed for håndsvejsning.
 Syn: Sinergic værdi.

Minimum	Maksimum	Default
1 cm/min	200 cm/min	10 cm/min

500 Indstilling af maskine



Gør det muligt at vælge den ønskede grafiske interface.
 Gør det muligt at få adgang til højere set up-niveauer.
 Se under "Skræddersyet interface (Set up 500)"

Værdi	Brugerinterface
XE	Tilstanden Easy
XA	Tilstanden Advanced
XP	Tilstanden Professional

Værdi	Markeret niveau
USER	Bruger
SERV	Service
vaBW	vaBW

551 Lock/unlock



Gør det muligt at låse kontrolpanelets indstillinger og at installere en beskyttelseskode.
 Se under "Lock/unlock (Set up 551)".

552 Summetone



Giver mulighed for at justere summetonen.

Minimum	Maksimum	Default
0/off	10	10

601 Reguleringstrin



Gør det muligt at regulere et parameter med trin, som man selv kan skræddersy

Minimum	Maksimum	Default
1	I _{max}	1

602 Ekstern parameter CH1, CH2, CH3, CH4



Gør det muligt at styre den eksterne parameter 1, 2, 3, 4 (minimumværdi, maksimumværdi, defaultværdi, valgte parameter).
 Se under "Styring fra eksternt udstyr (Set up 602)".

705 Justering af kredsløbsmodstand



Tillader at kalibrere anlægget.
 Se under "Justering af kredsløbsmodstand (set up 705)".

751 Strømaflæsning



Gør det muligt at se den faktiske værdi for svejsestrømmen.

752 Spændings aflæsning



Gør det muligt at aflæse den faktiske værdi for svejse spænding.

DA

758 Robothastighed

Gør det muligt at aflæse hastigheden for en robotarm eller andet automationudstyr.

768 Måling af tilført termisk energi HI

Tillader aflæsning af værdien på den tilførte termiske energi i svejsningen.

801 Stopgrænser

Gør det muligt at indstille advarselsværdier og stopværdier.

Gør det muligt at styre svejseprocessen ved at sætte advarselsgrænser og stopgrænser for de vigtigste målbare parametre.

Giver mulighed for nøje styring af de forskellige svejsefaser.

Se under "Stopgrænser (Set up 801)".

5.1.3 Liste over opsætningsparametre (MIG/MAG)
0 Lagr og luk

Giver mulighed for at lagre modifikationerne og forlade setup.

1 Reset



Giver mulighed for at indstille alle parametrene på defaultværdierne igen.

2 Svejseprogrammer

MIG/MAG-Standard:

Giver mulighed for at vælge den manuelle MIG-proces ( Off) eller den synergiske MIG-proces ( 6) ved indstilling af den materialetype, der skal svejses.

Puls MIG/MAG:

Giver mulighed for at vælge den synergiske MIG-proces ( 6) ved indstilling af den materialetype, der skal svejses.

Giver mulighed for at vælge den CC/CV-process.

3 Trådastighed

Gør det muligt at regulere trådfremføringshastigheden.

Minimum	Maksimum	Default
0.5 m/min	22.0 m/min	-

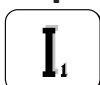
4 Strøm

Giver mulighed for at regulere svejsestrømmen.

Minimum	Maksimum
3 A	I _{max}

5 Arbejdsemnets tykkelse

Gør det muligt at indstille tykkelsen på det emne, der skal svejses.

Giver mulighed for at systemet indstilles via regulering af det emne, der p.t. svejses.

6 Vinkelsvejsning "a"

Gør det muligt at indstille svejsedybden i en vinkelsamling.

10 Præ-gas

Giver mulighed for at indstille og regulere gassens strømning, inden buen tændes.

Giver mulighed for at fylde gas på brænderen og forberede omgivelserne til svejsningen.

Minimum	Maksimum	Default
0/off	99.9 s	0.1 s

11 Soft start



Giver mulighed for at regulere trådens fremføringshastighed under tændingens forudgående faser.
Giver mulighed for en tænding ved nedsat hastighed og derved en mere blød tænding med færre stænk.

Minimum	Maksimum	Default
10 %	100 %	50 %

12 Motorrampe



Giver mulighed for at indstille en blød overgang mellem trådens hastighed ved tænding og under svejsning.

Minimum	Maksimum	Default
0/off	1.0 s	0/off

15 Burn back



Giver mulighed for at regulere trådens brændevarighed, hvorved tilklæbning ved svejsningens afslutning forebygges.

Giver mulighed for at regulere længden på brænderens udvendige stykke tråd.

Minimum	Maksimum	Default
-2.00	+2.00	0/syn

16 Post-gas



Giver mulighed for at regulere gassens strømning ved svejsningens afslutning.

Minimum	Maksimum	Default
0/off	99.9 s	2.0 s

19 Duty cycle (dobbel impuls)

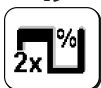

Tillader justering af arbejdscyklus ved dobbelt impuls.

Minimum	Maksimum	Default
10 %	90 %	50 %

20 Dobbelt puls



Gør det muligt at regulere pulsamplitude.

Minimum	Maksimum	Default
0 %	100 %	±25 %

Minimum	Maksimum	Default
0.5 m/min	22 m/min	2.5 m/min

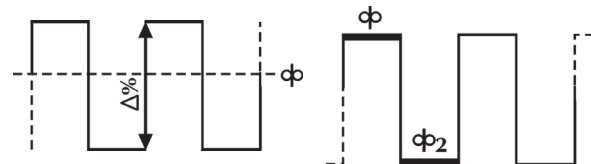

21 Impulsfrekvens (dobbel impuls)



Giver mulighed for at regulere cyklus, dvs. impulsrepetitionscyklus.

Gør det muligt at regulere impulsfrekvens.

Minimum	Maksimum	Default
0.1 Hz	5.0 Hz	2.0 Hz

22 Sekundær spænding (dobbel impuls)



Gør det muligt at regulere spændingen for det sekundære puls niveau.

Gør det muligt at opnå en større buestabilitet under de forskellige pulsfaser.

Minimum	Maksimum	Default
-5.0	+5.0	0/syn

23 Impulsmoduleret stigning/sænkning (dobbel impuls)



Tillader indstillingen af en rampetid i pulseringsfasen.

Minimum	Maksimum	Default
1 %	100 %	50 %

24 Bilevel (4T - crater filler)



Giver mulighed for at regulere den sekundære trådhastighed i tilstanden toplanssvejsning.

Hvis man trykker og slipper trykknappen i hurtig rækkefølge, skifter man til "φ₂".

Hvis man igen trykker og slipper trykknappen i hurtig rækkefølge, skifter man igen til "φ" og så videre.

Minimum	Maksimum	Default
1 %	200 %	0/off

DA

25 Startfasen

Gør det muligt at regulere trådhastigheden i den første "kraterfyldnings" svejsefase.

Gør det muligt at øge energitilførslen til emnet i den første fase, hvor materialet stadig er koldt og derfor har brug for højere temperatur for at smelte jævnt.

Minimum	Maksimum	Default
20 %	200 %	120 %

26 Crater filler

Gør det muligt at regulere trådhastigheden under svejsningens afsluttende fase.

Gør det muligt at mindske den energi, der tilføres emnet i den fase, hvor materialet er allerede meget varmt, hvorved risikoen for uønskede deformiteter mindskes.

Minimum	Maksimum	Default
20 %	200 %	80 %

27 Tidsindstilling for startforøgelse

Gør det muligt at indstille startforøgelsen.

Gør det muligt at automatisere funktionen "crater filler".

Minimum	Maksimum	Default
0.1 s	99.9 s	0/off

28 Tidsindstilling for crater filler

Gør det muligt at indstille "crater filler"-tiden.

Gør det muligt at automatisere funktionen "crater filler".

Minimum	Maksimum	Default
0.1 s	99.9 s	0/off

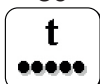
30 Punktsvejsning

Giver mulighed for at aktivere processen "punktsvejsning" og for at fastlægge svejsningens varighed.

Minimum	Maksimum	Default
0.1 s	99.9 s	0/off

31 Pausepunkt

Giver mulighed for at aktivere processen "pausepunkt" og fastlægge opholdstidsrummet mellem to svejsninger.

Minimum	Maksimum	Default
0.1 s	99.9 s	0/off

32 Sekundær spænding (Toplans MIG)

Gør det muligt at regulere spændingen for det sekundære puls niveau.

Gør det muligt at opnå en større buestabilitet under de forskellige pulsfaser.

Minimum	Maksimum	Default
-5.0	+5.0	0/syn

33 Sekundær induktans (Toplans MIG)

Gør det muligt at regulere induktans for det sekundære puls niveau.

Gør det muligt at få en hurtigere eller langsommere bue for at kompensere for svejserens bevægelser og for den naturlige ustabilitet ved svejsning.

Lav induktans = reaktiv bue (mere sprøjt).

Høj induktans = mindre reaktiv bue (mindre sprøjt).

Minimum	Maksimum	Default
-30	+30	0/syn

34 Indledende øgningstakt

Muliggør indstilling af gradvis overgang mellem indledende trådhastighed og trådhastighed under svejsning.

Minimum	Maksimum	Default
0 s	10 s	0/off

35

Kraterfyldningstakt

Muliggør indstilling af gradvis overgang mellem trådhastighed under svejsning og trådhastighed under kraterfyldning.

Minimum	Maksimum	Default
0 s	10 s	0/off

202

Induktans

Gør elektronisk regulering af serieinduktans i svejsekredsløbet mulig.

Gør det muligt at få en hurtigere eller langsommere bue for at kompensere for svejserens bevægelser og for den naturlige ustabilitet ved svejsning.

Lav induktans = reaktiv bue (mere sprøjt).

Høj induktans = mindre reaktiv bue (mindre sprøjt).

Minimum	Maksimum	Default
-30	+30	0/syn

331

Kompenseret mellemspænding

Gør det muligt at indstille svejsespændingen.

398

Referencekonstant for flytningshastighed

Referencekonstant for alle svejseprocesser

Værdi på hastigheden på brænderens flytning hvortil systemet refererer for at beregne svejseparametrene

399

Forskydningshastighed

Gør det muligt at indstille svejsningens udførelseshastighed.

Default cm/min: referencehastighed for håndsvejsning.

Syn: Sinergic værdi.

Minimum	Maksimum	Default
syn min	syn max	35 cm/min

500

Indstilling af maskine

Gør det muligt at vælge den ønskede grafiske interface.

Gør det muligt at få adgang til højere set up-niveauer.

Se under "Skræddersyet interface (Set up 500)"

Værdi	Brugerinterface
XE	Tilstanden Easy
XA	Tilstanden Advanced
XP	Tilstanden Professional

Værdi	Markeret niveau
USER	Bruger
SERV	Service
vaBW	vaBW

551

Lock/unlock

Gør det muligt at låse kontrolpanelets indstillinger og at installere en beskyttelseskode.

Se under "Lock/unlock (Set up 551)".

552

Summetone

Giver mulighed for at justere summetonen.

Minimum	Maksimum	Default
0/off	10	10

601

Reguleringstrin

Gør det muligt at regulere et parameter med trin, som man selv kan skræddersy

Funktionalitet styret af knap op / ned knap.

Minimum	Maksimum	Default
1	Imax	1

602

Ekstern parameter CH1, CH2, CH3, CH4

Gør det muligt at styre den eksterne parameter 1, 2, 3, 4 (minimumværdi, maksimumværdi, defaultværdi, valgte parameter).

Se under "Styring fra eksternt udstyr (Set up 602)".

606 Brænder U/D

Gør det muligt at styre den eksterne parameter (U/D).

Værdi	Default	Tilbagekaldsfunktion
0/off	-	off
1/I1	X	Strøm
	-	Hent program

612 Setting brænder DgMig

Tillader at administrere den digitale brænders kanaler.

Værdi	Default	Tilbagekaldsfunktion
0/off	-	off
1/I1	-	Strøm
2/ 	-	Hent program
3/CH3	-	CH3
4/CH4	-	CH4
5/STD	X	STD

653 Trådhastighed

Gør det muligt at regulere trådfremføringshastigheden (under påsætningstrinnet).

Minimum	Maksimum	Default
0.5 m/min	22.0 m/min	3.0 m/min

705 Justering af kredsløbsmodstand

Tillader at kalibrere anlægget.

Se under "Justering af kredsløbsmodstand (set up 705)".

751 Strømaflæsning

Gør det muligt at se den faktiske værdi for svejsestrømmen.

752 Spændingsaflysning

Gør det muligt at aflæse den faktiske værdi for svejse spænding.

755 Aflæsning af gasflow

Gør det muligt at se det reelle gasflow.

757 Trådhastighed

Muliggør visning af værdien for motorindkoder 1.

758 Robothastighed

Gør det muligt at aflæse hastigheden for en robotarm eller andet automationudstyr.

760 Strømaflæsning (motor 1)

Gør det muligt at se den faktiske værdi for motorstrømmen (motor 1).

768 Måling af tilført termisk energi HI



Tillader aflæsning af værdien på den tilførte termiske energi i svejsningen.

770 Værdi for nedlægningsmængden



Gør det muligt at se værdien for nedlægningsmængden

801 Stopgrænser



Gør det muligt at indstille advarselværdier og stopværdier.

Gør det muligt at styre svejseprocessen ved at sætte advarselgrænser og stopgrænser for de vigtigste målbare parametre.

Giver mulighed for nøje styring af de forskellige svejsefaser.

Se under "Stopgrænser (Set up 801)".

5.2 Specifikke procedurer for brug af parametrene

5.2.1 Skræddersy 7-segment displayet

Giver mulighed for konstant at visualisere en parameter værdi på displayet med 7 segmenter.

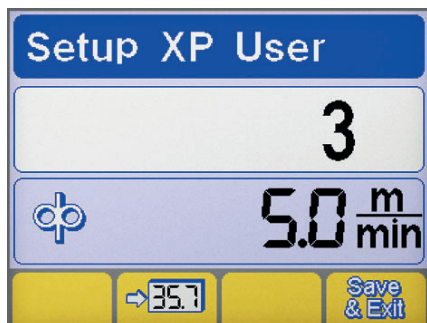

- ▶ Gå ind i opsætning ved at holde encoderknappen nede i mindst 5 sekunder.
- ▶ Vælg det ønskede parameter ved at dreje encodern.
- ▶ Gem det valgte parameter i 7-segment displayet ved at trykke på knappen .
- ▶ Gem og gå ud af skærbilledet ved at trykke på knappen .

5.2.2 Skræddersyet interface (Set up 500)

Gør det muligt med personlig tilpasning af parametrene i hovedskærbilledet.

500 Indstilling af maskine



Gør det muligt at vælge den ønskede grafiske interface.

Værdi	Brugerinterface
XE	Tilstanden Easy
XA	Tilstanden Advanced
XP	Tilstanden Professional

TILSTAND XE

MIG/MAG

Vejseparametre

Funktioner

TILSTAND XA

MIG/MAG

Vejseparametre

Funktioner

DA

TILSTAND XP

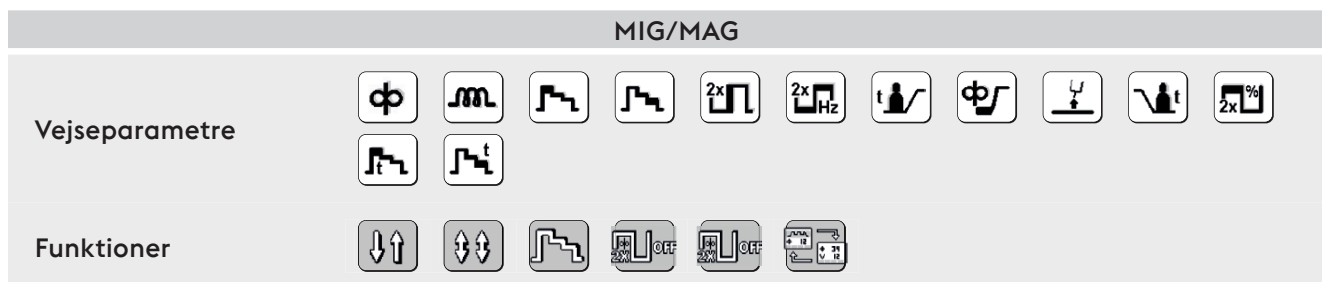

5.2.3 Lock/unlock (Set up 551)

Gør det muligt at låse kontrolpanelets indstillinger og at installere en beskyttelseskode.

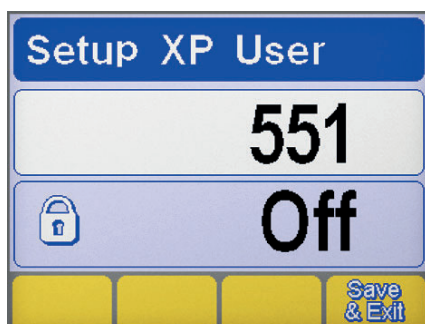

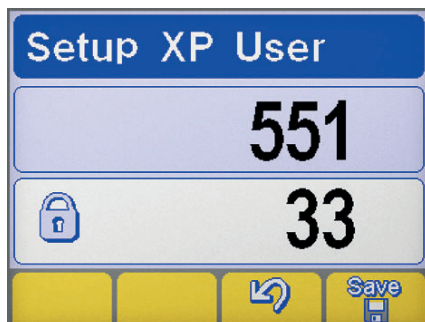

Parametermarkering

- ▶ Gå ind i opsætning ved at holde encoderknappen nede i mindst 5 sekunder.
- ▶ Vælg den ønskede parameter (551).
- ▶ Aktiver regulering af det valgte parameter ved at trykke på encoderknappen.



Indstilling af adgangskode

- ▶ Definer en numerisk kode (password) ved at dreje på encodern.
- ▶ Bekræft handlingen ved at trykke på encoder-tasten.
- ▶ Godkend ved at trykke på knappen .
- ▶ Modifikationen gemmes ved at trykke på knappen: .

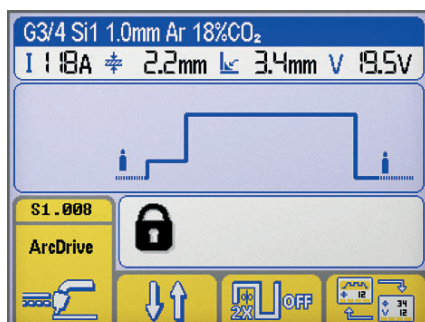

Panelfunktioner

- ▶ Gå ind i panelfunktionerne midlertidigt (5 minutter) ved at dreje endoceren og indtaste gyldigt password.
- ▶ Bekræft handlingen ved at trykke på encoder-tasten.
- ▶ Lås kontrolpanelet endeligt op ved at gå ind i opsætning (følg instrukserne ovenfor) og sæt parameter 551 tilbage på "off".
- ▶ Bekræft handlingen ved at trykke på encoder-tasten.
- ▶ Modifikationen gemmes ved at trykke på knappen: .

5.2.4 Styring fra eksternt udstyr (Set up 602)

Gør det muligt at styre den eksterne parameter 2 (minimumværdi, maksimumværdi, defaultværdi, valgte parameter).



Parametermarkering

- ▶ Gå ind i opsætning ved at holde encoderknappen nede i mindst 5 sekunder.
- ▶ Vælg den ønskede parameter (602).
- ▶ Gå ind i "Styring fra eksternt udstyr" skærmen ved at trykke på encoderknappen.

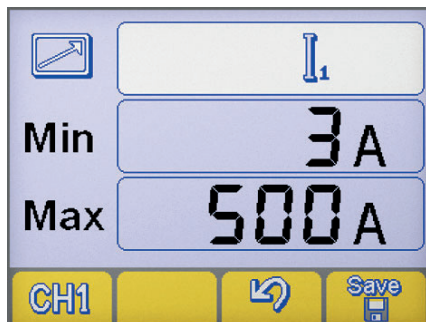

Styring fra eksternt udstyr

- ▶ Vælg den ønskede udgangskanal på fjernbetjeningen (CH1, CH2, CH3, CH4) ved at trykke på-knappen: **CH1**
- ▶ Vælg det ønskede parameter (Min-Max-parameter) ved at trykke på encoderknappen.
- ▶ Tilpas det valgte parameter (Min-Max-parameter) ved at dreje encoderen.
- ▶ Modifikationen gemmes ved at trykke på knappen: **Save**.
- ▶ Godkend ved at trykke på knappen **↵**.

5.2.5 Justering af kredsløbsmodstand (set up 705)

Giver mulighed for at kalibrere generatoren på det aktuelle svejsekredsløbs modstand.

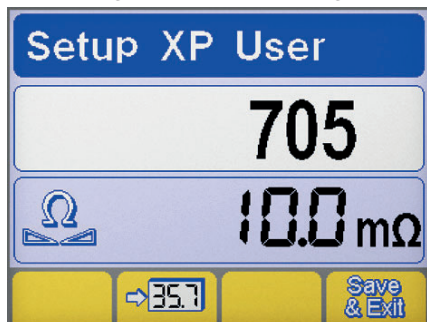

Parametermarkering

- ▶ Gå ind i opsætning ved at holde encoderknappen nede i mindst 5 sekunder.
- ▶ Vælg den ønskede parameter (705).
- ▶ Aktiver regulering af det valgte parameter ved at trykke på encoderknappen.
- ▶ Forbind generatoren til svejsekredsløbet (bænk eller emne).
- ▶ Tag hættten af for at blotlægge brænderens dyseholder. (MIG/MAG)

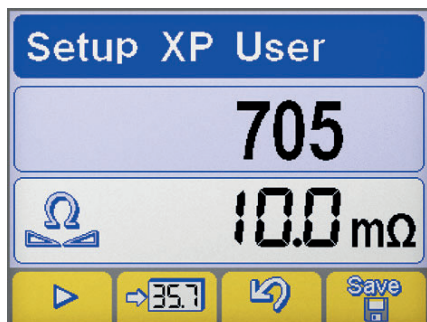

Kalibrering

- ▶ Bring trådføreren og det emne, som skal svejses, i elektrisk kontakt. (MIG/MAG)
- ▶ Tryk på knappen **▶** for at starte proceduren.
- ▶ Oprethold kontakten i mindst et sekund.
- ▶ Den viste værdi på displayet opdateres efter kalibreringen.
- ▶ Godkend ved at trykke på knappen **Save**.
- ▶ Godkend ved at trykke på knappen **↵**.
- ▶ Modifikationen gemmes og man forlader set up ved at trykke på tasten: **Save & Exit**.

5.2.6 Stopgrænser (Set up 801)

Gør det muligt at indstille advarselværdier og stopværdier.

Gør det muligt at styre svejseprocessen ved at sætte advarselgrænser og stopgrænser for de vigtigste målbare parametre.

Giver mulighed for nøje styring af de forskellige svejsefaser.

Se under "Stopgrænser (Set up 801)".



Advarselgrænser		Stopgrænser	
Svejsestrøm	Svejsespænding	Svejsestrøm	Svejsestrøm
Aflæsning af gasflow	Robothastighed	Strømaflæsning (motor 1)	Strømaflæsning (motor 2)
Aflæsning af kølemedieflow	Trådhastighed	Aflæsning af kølemedietemperatur	

DA

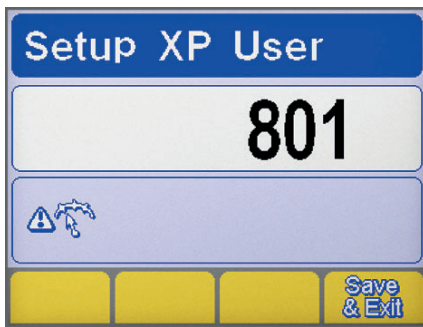

Parametermarkering

- ▶ Gå ind i opsætning ved at holde encoderknappen nede i mindst 5 sekunder.
- ▶ Vælg den ønskede parameter (801).
- ▶ Gå ind i "Stopgrænser" skærmbilledet ved at trykke på encoderknappen.

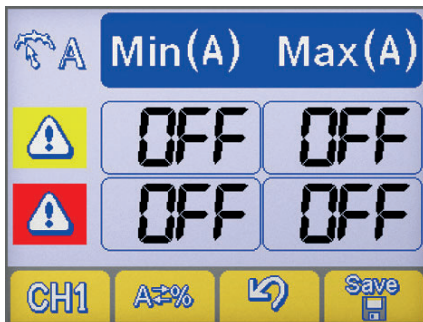

Markering af parameteren

- ▶ Vælg det ønskede parameter ved at trykke på knappen **CH1**.
- ▶ Vælg metode til at indstille stopgrænser ved at trykke på knappen **A=%**.



Indstilling af maskine



Absolut værdi



Procentværdi

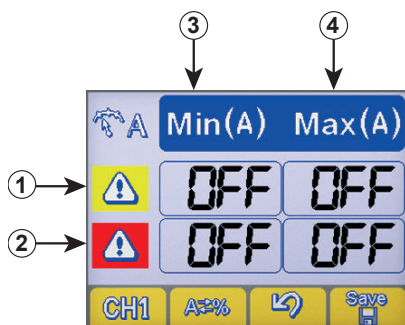

Indstilling af beskyttelsesgrænser

- 1 Advarselsgrænselinje
- 2 Alarmgrænselinje
- 3 Minimum-niveau søjle
- 4 Maksimum-niveau søjle

- ▶ Vælg den ønskede boks ved at trykke på encoderknappen (den valgte boks vises med modsat kontrast).
- ▶ Tilpas niveauet for den valgte grænse ved at dreje encoderen.
- ▶ Modifikationen gemmes ved at trykke på knappen: **Save**.



Hvis en af advarselsgrænserne overskrives, vil et signal kunne ses på kontrolpanelet.



Hvis en af alarmgrænserne overskrides, vil et signal kunne ses på kontrolpanelet, og svejsningen blokeres omgående.



Det er muligt at indstille start og slut svejsfiltre, for at forhindre at fejlsignal går i gang, når buen hhv. tændes og slukkes (se under "Opsætning" - Parameter 802-803-804).

6. EKSTRAUDSTYR

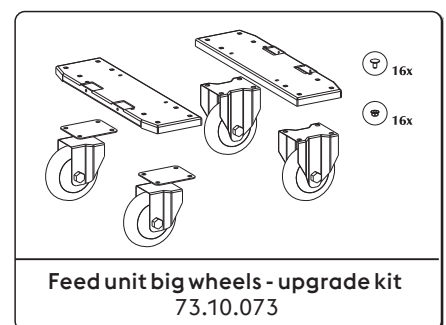
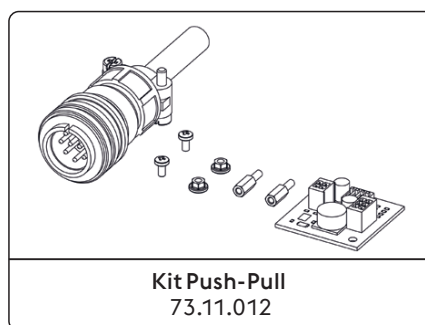
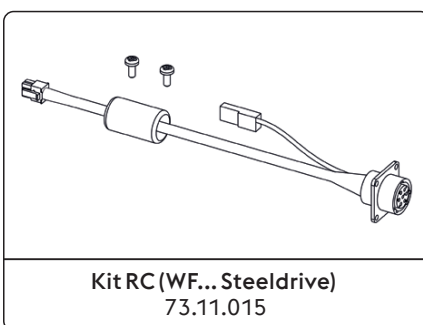

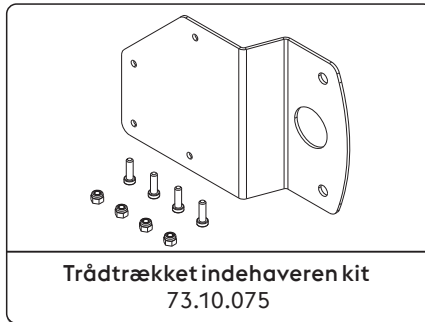
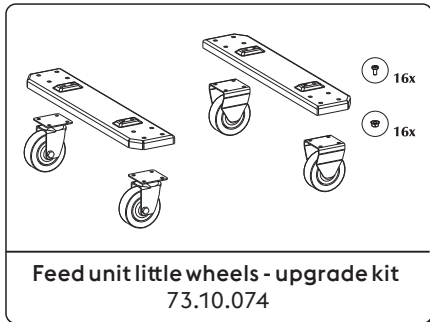

*Factory samling

Se under "Installering kit/ekstraudstyr".

7. VEDLIGEHOEDElse



Anlægget skal undergå en rutinemæssig vedligeholdelse i henhold til fabrikantens anvisninger. Alle adgangslåger, åbninger og dæksler skal være lukket og korrekt fastgjort, når apparatet er i funktion. Der må aldrig udføres nogen form for ændringer på anlægget. Undgå ophobning af metalstøvi nærheden af eller direkte på udluftningsvingerne.



Al vedligeholdelse skal udelukkende udføres af kvalificeret personale. Reparation eller udskiftning af anlægselementer udført af uautoriseret personale medfører øjeblikkeligt bortfald af produktgarantien. Eventuel reparation eller udskiftning af anlægselementer må udelukkende udføres af teknisk kvalificeret personale.



Afbryd strømforsyningen til anlægget inden enhver form for indgreb!

7.1 Regelmæssig kontrol af strømkilden



Rengør strømkilden indvendigt ved hjælp af trykluft med lavt tryk og bløde børster. Kontrollér de elektriske tilslutninger og alle forbindelseskabler.

7.2 Ответственность



Ved manglende udførelse af ovennævnte vedligeholdelse vil alle garantier bortfalde, og fabrikanten vil i alle tilfælde være fritaget for alle former for ansvar. Fabrikanten fralægger sig ethvert ansvar, hvis operatøren ikke overholder disse forskrifter. Ret henvendelse til det nærmeste servicecenter ved enhver tvivl og/eller ethvert problem.

8. ALARMKODER



ALARM

Indgriben fra en alarm eller overskridelsen af en kritisk beskyttelsesgrænse forårsager et visuelt signal på kontrolpanelet og den øjeblikkelige blokering af svejsningen.



PAS PÅ

Overskridning af en beskyttelsesgrænse medfører en visualisering af en signalering på kontrolpanelet, men tillader at fortsætte svejsehåndlingerne.

Alle alarmer og alle beskyttelsesgrænser for systemet er angivet nedenfor.

E01	Overtemperatur	
-----	----------------	--

E02	Overtemperatur	
-----	----------------	--

E05	Overstrøm	
-----	-----------	--













E07	Anomali på trådfremføringsmotorens forsyningsystem	
-----	--	--





























E08	Blokeret motor	
-----	----------------	--

E10	Overstrøm på effektmodul (Inverter)	
-----	-------------------------------------	--

E12.1	Kommunikationsfejl WF1	
-------	------------------------	--

E13	Kommunikationsfejl (FP)	
-----	-------------------------	--

 E14.xx	Ugyldigt program underfejlkoden angiver nummeret på det slettede job		 E15	Ugyldigt program	
 E16.1	Kommunikationsfejl RI 1000/2000/3000 (CAN bus)		 E16.2	Kommunikationsfejl RI 3000 (Modbus)	
 E16.3	Kommunikationsfejl RI 1000/2000		 E18.xx	Ugyldigt program underfejlkoden angiver nummeret på det slettede job	
 E19	Forkert konfiguration af anlæg		 E19.1	Forkert konfiguration af anlæg	
 E19.11	Forkert konfiguration af anlæg (WF)		 E20	Hukommelse defekt	
 E21	Tab af data		 E23	Svejseprogrammer ikke til stede	
 E27	Hukommelse defekt (RTC)		 E32	Tab af data	
 E33.1	Forkert konfiguration af anlæg (LCD 3.5")		 E33.3	Kommunikationsfejl (ACTIVATION KEY)	
 E33.4	Kommunikationsfejl (ACTIVATION KEY)		 E40	Anomali på anlæggets forsyning	
 E43	Kølevæskemangel		 E44	Gasmangel	
 E48	Trådmangel (Automation og robotstyring)		 E50	Sammenklisset tråd (Automation og robotstyring)	
 E54	Strømniveau overskredet (Nedre grænse)		 E55	Strømniveau overskredet (Øvre grænse)	
 E56	Overskredet spændingsniveau (Nedre grænse)		 E57	Overskredet spændingsniveau (Øvre grænse)	
 E58	Overskredet gasflowniveau (Nedre grænse)		 E59	Overskredet gasflowniveau (Øvre grænse)	
 E62	Strømniveau overskredet (Nedre grænse)		 E63	Strømniveau overskredet (Øvre grænse)	
 E64	Overskredet spændingsniveau (Nedre grænse)		 E65	Overskredet spændingsniveau (Øvre grænse)	
 E66	Overskredet gasflowniveau (Nedre grænse)		 E67	Overskredet gasflowniveau (Øvre grænse)	

 E71	Kølevæskeovertemperatur		 E74	Overskredet motorstrømniveau 1	
 E76	Overskredet kølevæskeflowniveau		 E77	Kølevæsketemperaturniveau	
 E80	Trådmangel (wire end)		 E81	Overstrøm (WU-pumpe)	
 E82	Kommunikationsfejl (WU)		 E83	Blokeret pumpe	
 E99.2	Systemkonfigurerings-alarm (inverter)		 E99.3	Systemkonfigurerings-alarm (FP)	
 E99.4	Systemkonfigurerings-alarm (FP)		 E99.5	Systemkonfigurerings-alarm (FP)	
 E99.6	Systemkonfigurerings-alarm		 E99.11	Hukommelse defekt	

9. FEJLFINDING OG LØSNINGER

Blokeret trådfremføring

Årsag

- » Fejlbehæftet brænderknap.
- » Ukorrekte eller nedslidte valser.
- » Defekt trådfremfører.
- » Beskadiget brænderbeklædning.
- » Trådtræk uden forsyning.
- » Irregulær opvikling på spolen.
- » Sammenbrændt svejsedyse (sammensmeltet tråd).

Løsning

- » Udskift den defekte komponent.
- » Kontakt nærmeste servicecenter og lad anlægget reparere.
- » Udskift valserne.
- » Udskift den defekte komponent.
- » Kontakt nærmeste servicecenter og lad anlægget reparere.
- » Udskift den defekte komponent.
- » Kontakt nærmeste servicecenter og lad anlægget reparere.
- » Kontroller tilslutningen til strømkilden.
- » Jævnfør afsnittet "Tilslutning".
- » Kontakt nærmeste servicecenter og lad anlægget reparere.
- » Genopret spolens normale vikleforhold eller skift den ud.
- » Udskift den defekte komponent.

Ujævn trådfremføring

Årsag

- » Fejlbehæftet brænderknap.
- » Ukorrekte eller nedslidte valser.
- » Defekt trådfremfører.
- » Beskadiget brænderbeklædning.
- » Dårligt justeret spoleholderkobling eller valseblokeringsanordning.

Løsning

- » Udskift den defekte komponent.
- » Kontakt nærmeste servicecenter og lad anlægget reparere.
- » Udskift valserne.
- » Udskift den defekte komponent.
- » Kontakt nærmeste servicecenter og lad anlægget reparere.
- » Udskift den defekte komponent.
- » Kontakt nærmeste servicecenter og lad anlægget reparere.
- » Løsn koblingen.
- » Forøg trykket på valserne.

Slaggeindslutning
Årsag

- » Ukomplet bortbearbejdning af slaggen.

- » Elektrodens diameter er for stor.

- » Ukorrekt forberedelse af kanterne.

- » Ukorrekt svejseafviklingstilstand.

Løsning

- » Udfør en omhyggelig rengøring af emnet, inden svejsningen udføres.

- » Benyt en elektrode med en mindre diameter.

- » Forøg spaltens åbning.

- » Reducer afstanden mellem elektrode og emne.

- » Sørg for, at fremføringen er regelmæssig under alle svejsefaserne.

Blæsning
Årsag

- » Utilstrækkelig gasbeskyttelse.

Løsning

- » Juster gasstrømmen.

- » Kontroller, at brænderens spreder og gasdyse er i god stand.

Sammensmeltning
Årsag

- » Ukorrekt buelængde.

- » Ukorrekte svejseparametre.

- » Ukorrekt svejseafviklingstilstand.

- » Emnerne, der skal svejses, er for store.

- » Ukorrekt buedynamik.

Løsning

- » Forøg afstanden mellem elektrode og emne.

- » Forøg svejse-/skærestrømmen.

- » Forøg svejse-/skærestrømmen.

- » Tilpas vinklen på brænderens hældning.

- » Forøg svejse-/skærestrømmen.

- » Forøg svejse-/skærestrømmen.

- » Forøg kredsløbets induktive værdi.

Marginale graveringer
Årsag

- » Ukorrekte svejseparametre.

- » Ukorrekt buelængde.

- » Ukorrekt svejseafviklingstilstand.

- » Utilstrækkelig gasbeskyttelse.

Løsning

- » Reducer svejsestrømmen.

- » Reducer afstanden mellem elektrode og emne.

- » Reducer svejse-/skærestrømmen.

- » Reducer sideoscillationshastigheden under påfyldning.

- » Reducer fremføringshastigheden under svejsning.

- » Benyt gas, der passer til det materiale, der skal svejses.

Oxideringer
Årsag

- » Utilstrækkelig gasbeskyttelse.

Løsning

- » Juster gasstrømmen.

- » Kontroller, at brænderens spreder og gasdyse er i god stand.

Porøsitet
Årsag

- » Tilstedeværelse af fedt, maling, rust eller snavs på de emner, der skal svejses.

- » Tilstedeværelse af fedt, maling, rust eller snavs på tilsatsmaterialet.

- » Fugtighedsforekomst i tilsatsmaterialet.

- » Ukorrekt buelængde.

- » Fugtighedsforekomst i svejsegassen.

- » Utilstrækkelig gasbeskyttelse.

Løsning

- » Udfør en omhyggelig rengøring af emnet, inden svejsningen udføres.

- » Benyt altid produkter og materialer af god kvalitet.

- » Hold altid tilsatsmaterialet i perfekt stand.

- » Benyt altid produkter og materialer af god kvalitet.

- » Hold altid tilsatsmaterialet i perfekt stand.

- » Reducer afstanden mellem elektrode og emne.

- » Reducer svejse-/skærestrømmen.

- » Benyt altid produkter og materialer af god kvalitet.

- » Sørg for at holde gasforsyningsanlægget i perfekt stand.

- » Juster gasstrømmen.

- » Kontroller, at brænderens spreder og gasdyse er i god stand.

» For hurtig størkning af svejsebadet.

- » Reducer fremføringshastigheden under svejsning.
- » Udfør en forvarmning af de emner, der skal svejses.
- » Forøg svejse-/skærestrømmen.

Knagelyd ved opvarmning

Årsag

- » Ukorrekte svejseparametre.
- » Tilstedeværelse af fedt, maling, rust eller snavs på de emner, der skal svejses.
- » Tilstedeværelse af fedt, maling, rust eller snavs på tilsatsmaterialet.
- » Ukorrekt svejseafviklingstilstand.
- » De emner, der skal svejses, har forskellige egenskaber.

Løsning

- » Reducer svejsestrømmen.
- » Udfør en omhyggelig rengøring af emnet, inden svejsningen udføres.
- » Benyt altid produkter og materialer af god kvalitet.
- » Hold altid tilsatsmaterialet i perfekt stand.
- » Udfør de korrekte driftssekvenser til den sammenføjning, der skal svejses.
- » Udfør en indsmøring, inden svejsningen udføres.

Knagelyd ved kolde emner

Årsag

- » Fugtighedsforekomst i tilsatsmaterialet.
- » Partikulær geometri i den sammenføjning, der skal svejses.

Løsning

- » Benyt altid produkter og materialer af god kvalitet.
- » Hold altid tilsatsmaterialet i perfekt stand.
- » Udfør en forvarmning af de emner, der skal svejses.
- » Udfør en eftervarmning.
- » Udfør de korrekte driftssekvenser til den sammenføjning, der skal svejses.

10. BETJENINGSVEJLEDNING

10.1 Svejsning med kontinuerlig tråd (MIG/MAG)

Indledning

Et MIG-system består af en jævnstrømskilde, en trådfremfører, en trådspole, en brænder og gas.

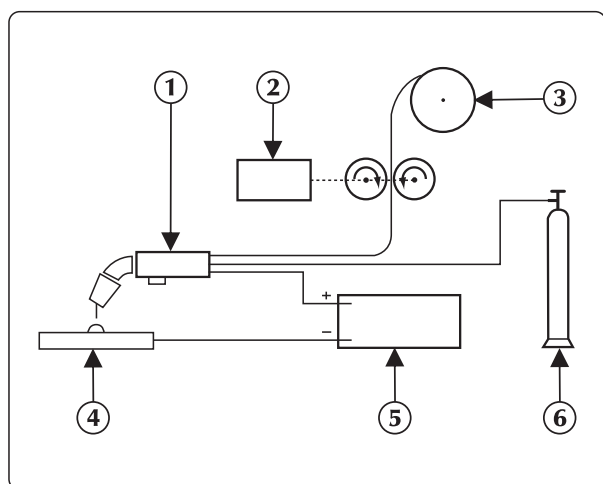

Anlæg til manuel svejsning

Strømmen overføres til lysbuen gennem smelte-elektroden (tråd anbragt med positiv polaritet); Under denne proces overføres det smeltede metal til svejseemnet ved hjælp af lysbuen.

Den automatiske fremføring af den kontinuerlige elektrode af tilsatsmateriale (tråden) er nødvendig for at erstatte den smeltede svejsetråd under svejsningen.

1. Brænder
2. Trådfremføring
3. Svejsetråd
4. Emne der skal svejses
5. Generator
6. Flaske

Procedurer

Ved svejsning med gasbeskyttelse, danner den måde, hvorpå dråberne skilles fra elektroden, to forskellige overføringssystemer. Ved den første metode, der defineres som "KORTSLUTNINGS-OVERFØRSEL (SHORT-ARC)", dannes et lille, hurtigt-størkende bad, hvor metallet kun overføres fra elektroden til svejseemnet i en kort periode, mens elektroden er i kontakt med badet. I dette tidsrum, hvor elektroden er i direkte kontakt med badet, opstår der en kortslutning med en smelteeffekt for en del af tråden, der afbrydes, hvorefter lysbuen tændes igen, og cyklussen gentages.

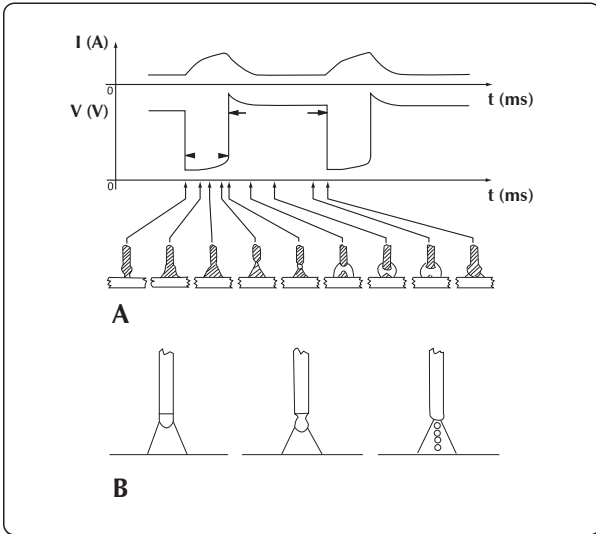

Cyklussen SHORT og svejsningen SPRAY ARC

Den anden metode for overførsel af dråberne er den såkaldte "SPRØJTE-OVERFØRSEL (SPRAY-ARC)", hvor metallet overføres i form af meget små dråber, der dannes og udskilles fra spidsen af tråden og overføres til badet via lysbustrålen.

Vejseparametre

Lysbuen synlighed reducerer kravet om, at operatøren nøje skal holde øje med reguleringstabellerne, da han kan kontrollere smeltebadet direkte.



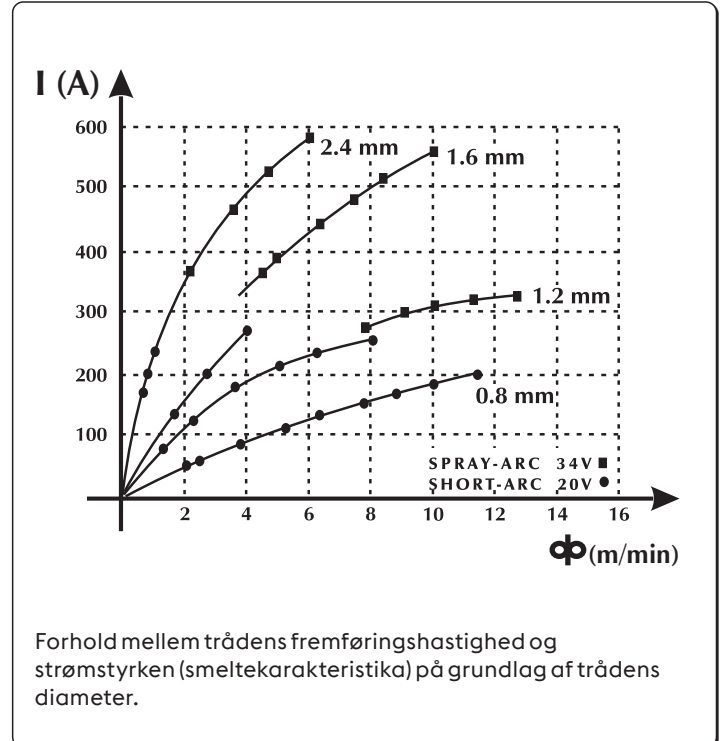
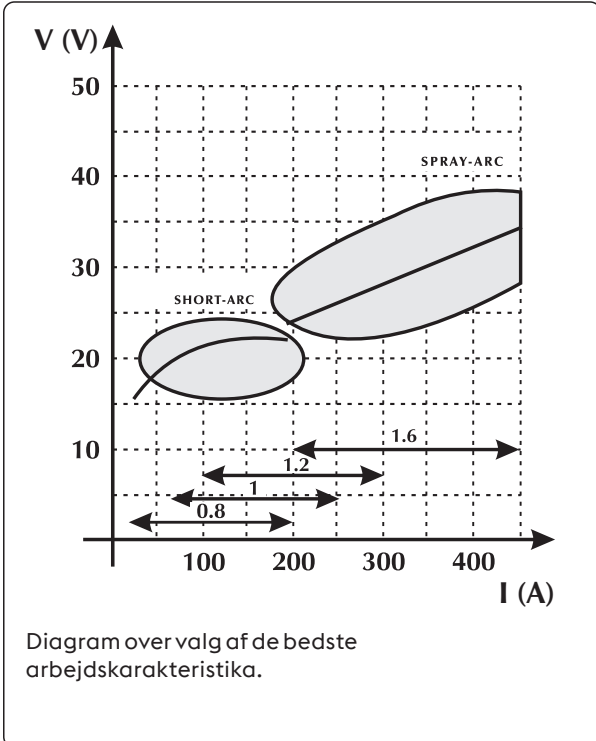

- Spændingen har direkte indflydelse på sømmens udseende, men svejse sømmens mål kan varieres efter de forskellige behov ved manuelt at justere brænderens bevægelse, således at man opnår varierende aflægninger med konstant spænding.
- Trådens fremføringshastighed afhænger af svejsestrømmen.

I de to nedenstående figurer illustreres forholdet som findes imellem de forskellige svejseparametre.

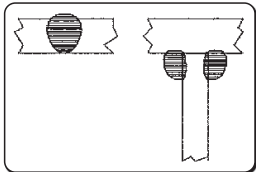
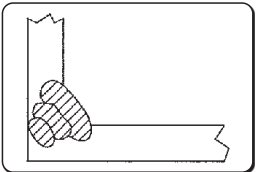
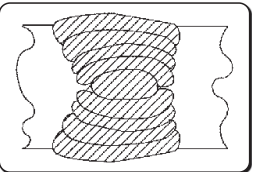

DA

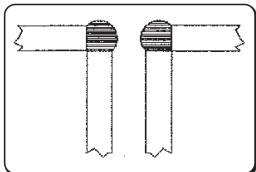
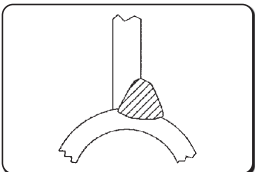
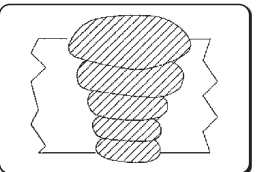
Vejledende tabel til valg af svejseparametrene i forhold til de mest almindelige arbejdsområder, samt de mest anvendte tråde

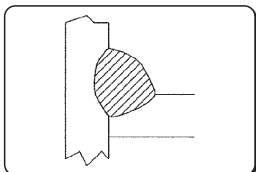
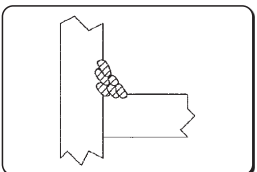
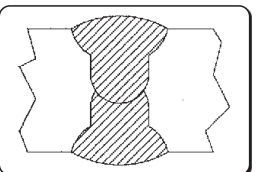
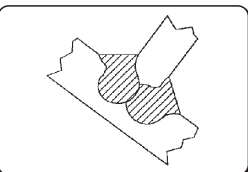
Lysbuespænding	Ø 0,8 mm	Ø 1,0-1,2 mm	Ø 1,6 mm	Ø 2,4 mm
16V - 22V SHORT - ARC				
	60 - 160 A Lav gennemtrængning ved små tykkelser	100 - 175 A God kontrol af gennemtrængningen og smeltningen	120 - 180 A God smeltning vandret og lodret	150 - 200 A Ikke anvendt
24V - 28V SEMI SHORT-ARC (Overgangszone)				
	150 - 250 A Automatisk hjørnesvejsning	200 - 300 A Automatisk svejsning med høj spænding	250 - 350 A Automatisk svejsning (faldende)	300 - 400 A Ikke anvendt
30V - 45V SPRAY - ARC				
	150 - 250 A Lav gennemtrængning ved regulering til 200 A	200 - 350 A Automatisk svejsning med flere gennemførsler	300 - 500 A God gennemtrængning (faldende)	500 - 750 A God gennemtrængning og høj aflejring på store tykkelser

Unalloyed steel

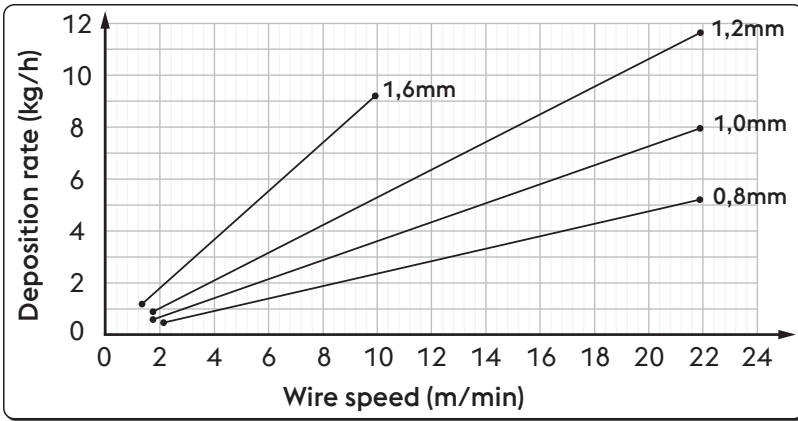

Ø	Wire speed	Deposition rate
0,8 mm	2,0 m/min	0,5 kg/h
	22,0 m/min	5,3 kg/h
1,0 mm	1,6 m/min	0,6 kg/h
	22,0 m/min	8,1 kg/h
1,2 mm	1,6 m/min	0,9 kg/h
	22,0 m/min	11,7 kg/h
1,6 mm	1,2 m/min	1,1 kg/h
	10,0 m/min	9,4 kg/h

High alloyed steel

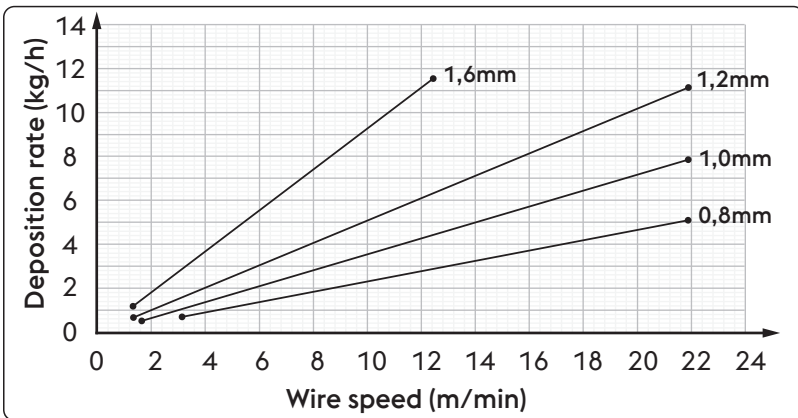

Ø	Wire speed	Deposition rate
0,8 mm	2,0 m/min	0,5 kg/h
	22,0 m/min	5,3 kg/h
1,0 mm	1,6 m/min	0,6 kg/h
	22,0 m/min	8,1 kg/h
1,2 mm	1,6 m/min	0,9 kg/h
	22,0 m/min	11,7 kg/h
1,6 mm	1,2 m/min	1,1 kg/h
	10,0 m/min	9,4 kg/h

Aluminum alloy

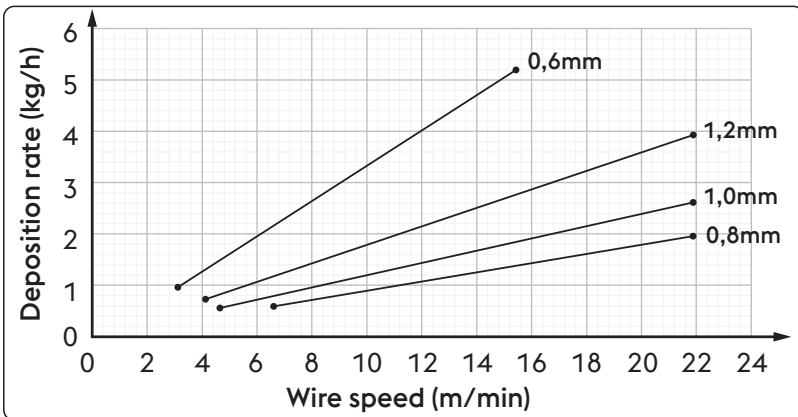

Ø	Wire speed	Deposition rate
0,8 mm	6,5 m/min	0,6 kg/h
	22,0 m/min	2,0 kg/h
1,0 mm	4,5 m/min	0,5 kg/h
	22,0 m/min	2,6 kg/h
1,2 mm	4,0 m/min	0,7 kg/h
	22,0 m/min	4,0 kg/h
1,6 mm	3,0 m/min	0,9 kg/h
	15,5 m/min	5,2 kg/h

DA

Anvendelige gasser

MIG-MAG-svejsning kendetegnes hovedsageligt af den anvendte gastype: inert til MIG-svejsning (Metal Inert Gas), aktiv til MAG-svejsning (Metal Active Gas).

- Kuldioxid (CO₂)

Ved anvendelse af CO₂ som beskyttelsesgas, opnår man høj gennemtrængning med stor fremføringshastighed, samt korrekte mekaniske egenskaber, samtidigt med en lav driftsomkostning. Alligevel medfører brug af denne gas store problemer vedrørende den afsluttende kemiske sammensætning af samlingerne, fordi der opstår tab af elementer, der har let ved at oxydere, og samtidigt tilføres der mere kulstof til badet.

Svejsning med ren CO₂ giver også andre problemer, såsom for store mængder sprøjt, samt opståelse af porøsitet, forårsaget af kullilte.

- Argon

Denne inaktive gas anvendes ren ved svejsning af letmetal-legeringer, hvorimod man til svejsning af rustfrit stål med krom-nikkel bør foretrække at arbejde med tilføjelse af oxygen og CO₂ i procentdelen 2 %, fordi dette forhold bidrager til lysbuen stabilitet og giver en forbedret form på svejsesømmen.

- Helium

Denne gas anvendes i stedet for argon, og giver større gennemtrængning (ved store tykkelser), samt større fremføringshastighed.

- Blanding af Argon og Helium

Ved denne blanding opnår man en mere stabil lysbue, samt større gennemtrængning og hastighed i forhold til argon.

- Blanding af Argon-CO₂ og Argon-CO₂-Oxygen

Disse blandinger anvendes til svejsning af jernholdige materialer, specielt under forhold med SHORT-ARC, fordi de forbedrer den specifikke varmetilførsel.

Dette medfører dog ikke, at de ikke kan anvendes ved SPRAY-ARC.

Normalt indeholder blandingen en procentdel af CO₂ på mellem 8% og 20 % og O₂ på omtrent 5 %.

Se i anlæggets brugervejledning.

Unalloyed steel / High alloyed steel		Aluminum alloy	
Strømområde	Gasstrøm	Strømområde	Gasstrøm
3-50 A	10-12 l/min	3-50 A	10-12 l/min
30-100 A	10-14 l/min	30-100 A	10-15 l/min
75-150 A	12-16 l/min	75-150 A	12-18 l/min
150-250 A	14-18 l/min	150-250 A	14-22 l/min
250-400 A	16-20 l/min	250-400 A	16-25 l/min
400-500 A	18-22 l/min	400-500 A	18-30 l/min

11. TEKNISKE SPECIFIKATIONER

Egenskaber for trådfremføringsenheden WF NX 430 SteelDrive		U.M.
Type gearmotor	SL4R-4T	
Gearmotorens effekt	120	W
Antal valser	4	
Tråddiameter / Standardrulle	1.0-1.2	mm
Diameter på anvendelige tråde / Ruller, der kan forhandles om	Trådfremføringshastigheden 0.8-1.6 aluminiumstråd 1.2-2.4 tråd med væge	mm/materiale
Knap til gasudluftning	ja	
Knap til trådfremførelse	ja	
Knap til tilbagetrækning af tråden	nej	
Trådhastighed	25 Ø 0.8 - 1.0	m/min
Synergier	ja	
Eksterne anordninger	ja (valgfri)	
Stikkontakt til Push-Pull brænder	ja (valgfri)	
Diameter på spole	200/300	mm
Diameter på forhjul	63/125 (optional)	mm
Diameter på baghjul	63/125 (optional)	mm
Elektriske egenskaber WF NX 430 SteelDrive		U.M.
Forsyningsspænding U1	48	Vdc
Kommunikationstype	DIGITAL	
Maks. strøm optaget I1maks.	4.5	A
Brugsfaktor WF NX 430 SteelDrive		U.M.
Brugsfaktor (40°C)		
(X=50%)	500	A
(X=60%)	470	A
(X=100%)	420	A
Brugsfaktor (25°C)		
(X=80%)	500	A
(X=100%)	470	A
Fysiske egenskaber WF NX 430 SteelDrive		U.M.
IP-beskyttelsesgrad	IP23S	
Dimensioner (lxdxh)	640x250x460	mm
Vægt	19.0	Kg
Bygningsstandarder	EN IEC 60974-5:2019 EN 60974-10/A1:2015	

12. DATASKILT

VOESTALPINE BÖHLER WELDING SELCO S.R.L. Via Palladio,19 - ONARA (PADOVA) - ITALY			
WF NX 430		N°	
EN 60974-5:2019 IEC 60974-10/A1:2015 Class A			
	X (40°C)	60%	100%
	I ₂	500A	400A
	U ₁ 48V	I _{1max} 4.5A	
IP 23 S		UK CA CE EAC	
MADE IN ITALY			

13. BETYDNING AF OPLYSNINGERNE DATASKILT

1		2	
3		4	
5			
	6	6A	6B
	7	7A	7B
8	9	10	
11		UK CA CE EAC	
MADE IN ITALY			

- 1 Fremstillingsmærke
- 2 Navn og adresse på producenten
- 3 Apparatets model
- 4 Serienummer
- X**XX**XXXXXXXXXX Produktionsår
- 5 Henvisning til konstruktionsstandarder
- 6 Symbol for intermitterende cyklus
- 7 Symbol for nominal svejsestrøm
- 6A Værdier for intermitterende cyklus
- 6B Værdier for intermitterende cyklus
- 7A Værdier for nominal svejsestrøm
- 7B Værdier for nominal svejsestrøm
- 8 Symbol for strømforsyning
- 9 Nominal forsyningsspænding
- 10 Maksimal nominal strømforsyningsstrøm
- 11 Beskyttelsesgrad

CE EU-overensstemmelseserklæring
 EAC EAC-overensstemmelseserklæring
 UKCA UKCA-overensstemmelseserklæring

DA

EU-SAMSVARSERKLÆRING

Byggherren
voestalpine Böhler Welding Selco S.r.l. - Via Palladio, 19 - 35019 Onara di Tombolo (PD) - ITALY
Tel. +39 049 9413/111 - Fax +39 049 9413/311 - www.voestalpine.com/welding

erklærer under eget ansvar at følgende produkt:

WF NX 430 STEELDRIVE 71.01.083

er i samsvar med EU-direktivene:

2014/35/EU LOW VOLTAGE DIRECTIVE

2014/30/EU EMC DIRECTIVE

2011/65/EU RoHS DIRECTIVE

og at følgende harmoniserte standarder er anvendt:

EN IEC 60974-5:2019

WIRE FEEDERS

EN 60974-10/A1:2015

ELECTROMAGNETIC COMPATIBILITY REQUIREMENTS

Dokumentasjonen som bekrefter overholdelse av direktivene vil holdes tilgjengelig for inspeksjon hos den nevnte produsenten.

Ethvert inngrep eller forandring som ikke er autorisert av voestalpine Böhler Welding Selco S.r.l. ugyldiggjør denne erklæringen.

Onara di Tombolo, 03/07/2023

voestalpine Böhler Welding Selco s.r.l.

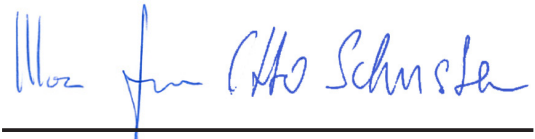

Mirco Frasson

Otto Schuster

Managing Directors

INNHOLDSFORTEGNELSE

1. ADVARSEL	347
1.1 Bruksmiljø.....	347
1.2 Personlig beskyttelse og beskyttelse av tredje mann	347
1.3 Beskyttelse mot røyk og gass	348
1.4 For å forebygge brann/eksplosjoner.....	348
1.5 Forebyggelse ved bruk av gassbeholder	349
1.6 Vern mot elektrisk støt.....	349
1.7 Elektromagnetiske felt og forstyrrelser	349
1.8 Vernegrad IP	350
1.9 Avhending	350
2. INSTALLASJON.....	350
2.1 Løfting, transport og lossing.....	350
2.2 Plassering av anlegget	351
2.3 Kopling.....	351
2.4 Installasjon.....	351
3. PRESENTASJON AV ANLEGGET	353
3.1 Bakpanel.....	353
3.2 Støpselpanel	353
3.3 Frontpanel med kontroller	354
4. BRUK AV UTSTYRET.....	355
4.1 Startskjerm.....	355
4.2 Testskjerm.....	355
4.3 Hovedskjerm.....	355
5. INNSTILLING.....	359
5.1 Oppsett og innstillinger av parametrene	359
5.2 Spesifikke prosedyrer for bruk av parameterene.....	368
6. TILBEHØRSSETT.....	371
7. VEDLIKEHOLD	372
7.1 Utfør følgende periodiske inngrep på generatoren.....	372
7.2 Sorumluluk.....	372
8. ALARM KODER	372
9. DIAGNOSTIKK OG LØSNINGER.....	374
10. DRIFTSINSTRUKSJONER	376
10.1 Kontinuerlig trådsveising (MIG/MAG).....	376
11. TEKNISK SPESIFIKASJON.....	381
12. DATASKILT	382
13. BESKRIVELSE INFORMASJONSSKILT.....	382
14. SKJEMA.....	459
15. SKJØTEMUNNSTYKKER.....	460
16. LISTE OVER RESERVEDELER.....	461
17. INSTALLASJON KIT/TILBEHØRSSETT	464

SYMBOLNES FORKLARING



Store farer som forårsaker alvorlige skader på personer og farlig oppførsel som kan føre til alvorlige skader.



Viktig råd for å unngå mindre skader på personer eller gjenstander.



Tekniske merknader for å lette operasjonene.

1. ADVARSEL



Før du begynner operasjonene, må du forsikre deg om å ha lest og forstått denne håndboka.

Utfør ikke modifiseringer eller vedlikeholdsarbeid som ikke er beskrevet. Produsenten er ikke ansvarlig for skader på personer eller ting som oppstår på grunn av mangelfull forståelse eller manglende utførelse av instruksjonene i denne håndboka.

Bruksanvisningen skal alltid oppbevares der apparatet er i bruk. I tillegg til bruksanvisningen skal også generelle og lokale regler om ulykkesforebygging og miljø følges.



Alle personer som jobber med idriftsetting, betjening, vedlikehold og reparasjon av apparatet, skal:

- være tilsvarende kvalifisert
- ha kjennskap til sveising
- ha lest hele bruksanvisningen og følge denne

Ved tvil og problemer om bruken av anlegget, skal du henvende deg til kvalifisert personell.

1.1 Bruksmiljø



Alt utstyr skal kun brukes for operasjoner som det er prosjektert til, på den måte og i områdene som er angitt på skiltet og/eller i denne håndboka, i samsvar med nasjonale og internasjonale direktiver om sikkerhet. Bruk som skiller seg fra bruksmønster angitt av fabrikanten er ikke egnet og kan være farlig; i et slikt tilfelle frasier fabrikanten seg alt ansvar.



Denne enheten må brukes kun i profesjonelle applikasjoner i industrimiljøer. Fabrikanten er ikke ansvarlig for skader som er forårsaket ved privat bruk av anlegget.



Anlegget skal brukes i miljøer med en temperatur mellom -10°C og $+40^{\circ}\text{C}$ (mellom $+14^{\circ}\text{F}$ og $+104^{\circ}\text{F}$).

Anlegget skal transporteres og oppbevares i miljøer med en temperatur mellom -25°C og $+55^{\circ}\text{C}$ (mellom -13°F og 131°F).

Anlegget skal brukes i miljøer fritt for støv, syre, gass eller andre etsende stoffer.

Anlegget må ikke brukes i miljøer med en luftfuktighet over 50% ved 40°C (104°F).

Anlegget må ikke brukes i miljøer med en luftfuktighet over 90% ved 20°C (68°F).

Anlegget må ikke brukes høyere enn 2000m over havet.



Ikke bruk denne typen apparat for å tine opp frosne rør.

Bruk aldri apparatet for å lade batterier og/eller akkumulatorer.

Bruk ikke apparatet for å starte motorer.

1.2 Personlig beskyttelse og beskyttelse av tredje mann



Sveiseprosedyren kan danne farlig stråling, støy, varme og gass. Installer et brannsikert skillerom for å beskytte sveisesonen fra stråler, gnister og glødende slagg. Advar alle mennesker i nærheten at de ikke må feste blikket på sveisebuen eller på det glødende metallet, og få en brukbar beskyttelse.



Ha på deg verneklær for å beskytte huden fra strålene, gnistene eller på det glødende metallet, og få en tilfredsstillende beskyttelse. Du må ha på deg egnet klær som dekker hele kroppen og er:

- hele og i god stand
- ikke brannfarlige
- isolerende og tørre
- tettsittende og uten mansjetter og oppbrett



Bruk alltid foreskrevne sko som er sterk og er garantert vanntett.

Bruk alltid foreskrevne hansker som isolerer mot elektrisitet og varme.



Bruk masker med sidebeskyttelser for ansiktet og egnet beskyttelsesfilter (minst NR10 eller mere) for øyene dine.



Ha alltid på deg vernebriller med sideskjermer spesielt under manuelle eller mekanisk fjerning av sveiseslagg.



Bruk aldri kontaktlinser!



Bruk hørselvern hvis sveiseprosedyren forårsaker farlig støy. Hvis støynivået overstiger de tillatte grensene, må du avgrense arbeidssonen og forsikre deg om at personene som befinner seg i sonen er utstyrt med hørselvern.



Hold alltid sidepanelene lukket under sveiseprosedyren. Du skal ikke utføre endringer på anlegget. Unngå kontakt mellom hender, hår, klær, utstyr... og bevegelige deler som: vifter, tannhjul, valser og spindler, trådspoler. Ikke berør tannhjul når trådtrekkeren er igang. Utkopling av sikkerhetsutstyr på enhetene for fremtrekk av tråden er meget farlig og fritar fabrikanten for ethvert ansvar med hensyn til skader på utstyr eller personer.



Hold hodet borte fra Mig-/Mag-sveisebrenneren under lading og fremtrekk av tråden. Tråden som kommer ut kan føre til alvorlige skader på hendene, ansiktet og øyene.



Unngå å røre ved delene som du nettopp har sveiset, da den høye temperaturen kan føre til alvorlige forbrenninger eller skader.

Følg alle forholdsregler som er beskrevet også i bearbeidelsene etter sveisingen, da stykkene som du sveiset kan gi fra seg slaggrester mens de avkjøles.



Forsikre deg om at sveisebrenneren er avkjølet før du utfører arbeid eller vedlikehold på den.



Forsikre deg om at kjøleaggregatet er slått av før du frakopler slanger for tilførsel og retur av kjølevæsken. Den varme væsken som kommer ut kan føre til alvorlige forbrenninger eller skålding.



Forsikre deg om at det finnes et førstehjelpskrin i nærheten. Ikke undervurder forbrenninger eller sår.



Før du forlater arbeidsplassen, skal du forsikre deg om at sonen er sikker for å forhindre ulykker som kan føre til skader på utstyr eller personer.

1.3 Beskyttelse mot røyk og gass



Røyk, gass og støv som dannes under sveisingen kan være farlige for helsen.

Røyken som blir produsert under sveiseprosedyren kan føre til kreft eller fosterskade på kvinner som er gravide.

- Hold hodet borte fra sveisegass og sveiserøyk.
- Forsikre deg om at ventilasjonen er fullgod, naturlig eller luftkondisjonering, i arbeidssonen.
- Ved utilstrekkelig ventilasjon, skal du bruke ansiktsmaske med luftfilter.
- Ved sveising i trange miljøer, anbefaler vi deg å ha oppsyn med operatøren ved hjelp av en kollega som befinner seg ute.
- Bruk aldri oksygen for ventilasjon.
- Kontroller oppsugets effektivitet ved regelmessig å kontrollere mengden av skadelig gass som blir fjernet i forhold til verdiene fastsatt i sikkerhetsnormene.
- Mengden og farlighetsgraden av røyken som blir generert beror på basismaterialet som blir brukt, støttematerialet og alle eventuelle stoffer som er brukt for rengjøring og fjerning av fett fra stykkene som skal sveises. Følg nøye instruksene fra fabrikanten og tilhørende tekniske spesifikasjoner.
- Utfør ikke sveiseprosedyren i nærheten av plasser hvor avfetting eller maling skjer.
- Plasser gassbeholdere utendørs eller på en plass med god luftsirkulasjon.

1.4 For å forebygge brann/eksplosjoner



Sveiseprosedyren kan forårsake brann og/eller eksplosjoner.

- Fjern alle brannfarlige eller lettantennelige materialer eller gjenstander fra arbeidssonen.
- Brannfarlige stoffer må være på minst 11 meters avstand fra sveisemiljøet og beskyttes på egnet måte.
- Gnistsprut og glødende partikler kan lett nå sonene rundt enheten også gjennom små åpninger. Vær spesielt forsiktig med å beskytte gjenstander og personer.
- Utfør ikke sveisingen på eller i nærheten av trykkbeholdere.
- Utfør ikke sveiseoperasjoner på lukkede beholdere eller rør. Vær meget forsiktig ved sveising av rør eller beholdere selv om de er åpen, tømt og rengjort med stor omhu. Rester av gass, drivstoff, olje eller lignende kan føre til eksplosjon.
- Du skal ikke sveise i miljøer hvor det er støv, gass eller eksplosiv damp.
- Etter sveisingen skal du forsikre deg om at kretsen under spenning ikke kan komme bort i delene som er koplet til jordledningskretsen.
- Plasser et brannslukningsapparat i nærheten av maskinen.

1.5 Forebyggelse ved bruk av gassbeholder



Inerte gassbeholdere inneholder gass under trykk og kan eksplodere hvis du ikke sikrer forholdene for transport, vedlikehold og bruk.

- Gassbeholderne skal være festet vertikalt ved veggen eller andre støtteinnretninger for å unngå fall og plutselige mekaniske støt.
- Stram vernehetten på ventilen under transport, oppstart og hver gang du avslutter sveiseprosedyren.
- Unngå å utsette beholderne direkte for solstråler, plutselige temperaturforandringer, for høye eller ekstreme temperaturer. Utsett ikke gassbeholderne for altfor høye eller lave temperaturer.
- Hold beholderne vekk fra flammer, elektriske buer, sveisebrennere eller elektrodeholdetenger og glødende deler som fremkommer under sveiseprosedyren.
- Hold beholderne borte fra sveisekretsene og strømkretsene generelt.
- Hold hodet borte fra gassutslippet når du åpner beholderens ventil.
- Lukk alltid beholderens ventil når du avslutter sveiseprosedyrene.
- Utfør aldri sveising på en gassbeholder under trykk.
- Kople aldri en trykkluftsbekholder direkte til maskinens reduksjonsventil! Trykket kan overstige reduksjonsventilens kapasitet og eksplodere!

1.6 Vern mot elektrisk støt



Et elektrisk støt kan være dødelig.

- Unngå å røre ved innvendige eller utvendige deler som er forsynt med strøm i sveise mens anlegget er slått på (sveisebrenner, tenger, jordledninger, elektroder, ledninger, ruller og spoler er elektrisk koplet til sveisekretsen).
- Forsikre deg om at anleggets og operatørens elektriske isolering er korrekt ved å bruke tørre steder og gulv som skal være tilstrekkelig isolert fra jord.
- Forsikre deg om at anlegget er korrekt koplet til uttaket og at nettet er utstyrt med en jordforbindelse.
- Berør aldri samtidig to sveisebrennere eller to elektrodeholdertenger.
- Avbryt umiddelbart sveiseprosedyren hvis du føler elektriske støt.

1.7 Elektromagnetiske felt og forstyrrelser



Strømmen gjennom de innvendige og utvendige kablene i anlegget danner elektromagnetiske felt i nærheten av sveisekablene og anlegget.

- De elektromagnetiske feltene kan ha innvirkning på helsen til operatører som er utsatt for feltene under lange perioder (nøyaktig påvirkning er idag ukjent).
- De elektromagnetiske feltene kan påvirke andre apparater som pacemaker eller høreapparater.



Alle personer som har livsviktige elektroniske apparater (pace-maker) må henvende seg til legen før de nærmer seg soner hvor sveiseoperasjonene.

1.7.1 EMC overensstemmelse med: EN 60974-10/A1:2015.

Klasse
B

Utstyr klasse B er i overensstemmelse med elektromagnetiske kompatibilitetskrav i industriell og beboelsesmiljø, inkludert boligområder hvor den elektriske kraft er forsynt fra det offentlige lavspennings forsyningssystem.

Klasse
A

Utstyr klasse A er ikke ment for bruk i boligområder hvor den elektriske kraft er forsynt fra det offentlige lavspennings forsyningssystem. Det kan være potensielle vanskeligheter i å sikre elektromagnetisk kompatibilitet av utstyr klasse A i disse områder, på grunn av styrte såvel som utstrålte forstyrrelser.

For mer informasjon, se kapittelet: DATASKILT eller TEKNISK SPESIFIKASJON.

1.7.2 Installasjon, bruk og vurdering av området

Dette apparatet er konstruert i samsvar med kravene i den harmoniserte normen EN 60974-10/A1:2015 og er identifisert som "KLASSE A". Denne enheten må brukes kun i profesjonelle applikasjoner i industrimiljøer. Fabrikanten er ikke ansvarlig for skader som er forårsaket ved privat bruk av anlegget.



Brukeren må ha erfaringer i sektoren og er ansvarlig for installasjonen og bruken av enheten i overensstemmelse med fabrikantens anvisninger. Hvis elektromagnetiske forstyrrelser oppstår, er det brukeren som må løse problemet, om nødvendig ved hjelp av fabrikantens tekniske assistanse.



Uansett må de elektromagnetiske forstyrrelsene bli redusert slik at de ikke utgjør et problem.



Før du installerer denne enheten, må du ta i betraktning mulige elektromagnetiske problemer som kan oppstå i området og som kan være farlige for personene som er i området, f.eks. personer som bruker pace-maker eller høreapparater.

1.7.3 Forholdsregler for kabler

For å minke effektene av elektromagnetiske felt, skal du følge disse reglene:

- Hvis mulig skal du bunte sammen jordledningen og nettkabelen.
- Aldri tvinn kablene rundt kroppen.
- Unngå å stille deg mellom jordledningen og nettkabelen (hold begge kablene på samme side).
- Kablene skal være så korte som mulig, og plasseres så nær hverandre som mulig og lagt på eller omtrentlig på gulvnivået.
- Plasser anlegget på noe avstand fra sveiseområdet.
- Kablene plasseres på avstand fra eventuelle andre kabler.

1.7.4 Jording

Jording av alle metallkomponenter i sveiseanlegget og dens miljø må tas i betraktning. Følg nasjonale og lokale forskrifter for jording.

1.7.5 Jording av delen som skal bearbeides

Hvis delen som skal bearbeides ikke er jordet av elektriske sikkerhetsgrunner eller på grunn av dens dimensjoner og plassering, kan du bruke en jordledning mellom selve delen og jordkontakten for å minke forstyrrelsene. Vær meget nøye med å kontrollere at jordingen av delen som skal bearbeides ikke øker risikoen for ulykker for brukerne eller risikoen for skader på andre elektriske apparater. Følg gjeldende nasjonale og lokale forskrifter for jording.

1.7.6 Skjerming

Skjerming av andre kabler og apparater i nærheten kan redusere problemet med forstyrrelser.

Skjerming av hele sveiseanlegget kan være nødvendig for spesielle applikasjoner.

1.8 Vernegrad IP



IP23S

- Innhold som er beskyttet mot tilgang til farlige deler med fingrene og innføring av massive fremmedlegemer med en diameter som overstiger/er lik 12,5 mm.
- Innholdet er beskyttet mot regn i en skråvinkel på 60°.
- Innholdet er beskyttet mot skadelige effekter grunnet inntrenging av vann, når apparatets bevegelige deler ikke er igang.

1.9 Avhending



Ikke sluttbehandle apparatet som usortert kommunalt avfall!

I samsvar med EU-direktiv 2012/19/EU om avfall fra elektrisk og elektronisk utstyr og implementering av direktivet i samsvar med nasjonal lovgivning, skal elektrisk utstyr ved levetidens utløp innsamles separat og leveres inn til et innsamlingscenter. Eieren av utstyret må kontakte de lokale myndighetene for informasjon om nærmeste innsamlingscenter. Anvendelsen av EU-direktivet vil forbedre miljøet og menneskehelsen.

» Gå inn på nettstedet for mer informasjon.

2. INSTALLASJON



Installasjonen kan kun utføres av profesjonelt personale som er autorisert av fabrikanten.



Under installasjonen, skal du forsikre deg om at generatoren er frakoplet.

2.1 Løfting, transport og lossing

- Anlegget er utstyrt med et håndtak som muliggjør manuell transportering.
- Anlegget er ikke utstyrt med spesifikke deler for løfting.
- Bruk en gaffeltruck og vær meget forsiktig ved bevegelsene for å unngå at generatoren faller i bakken.



Ikke undervurder anleggets vekt, (se teknisk spesifisering).

Ikke la lasten bevegges eller henges over personer eller ting.

Ikke dropp eller belaste anlegget med unødvendig tyngde.

2.2 Plassering av anlegget



Følg disse reglene:

- Gi lett adgang til kontrollene og kontaktene.
- Plasser ikke utstyret i trange rom.
- Sett aldri anlegget på en flate med en skråning som overstiger 100 fall.
- Plasser anlegget på en tørr og ren plass med tilstrekkelig ventilasjon.
- Beskytt anlegget mot regn og sol.

2.3 Kopling





De mobile enhetene fra skal forsynes kun med lavspenning.

2.4 Installasjon

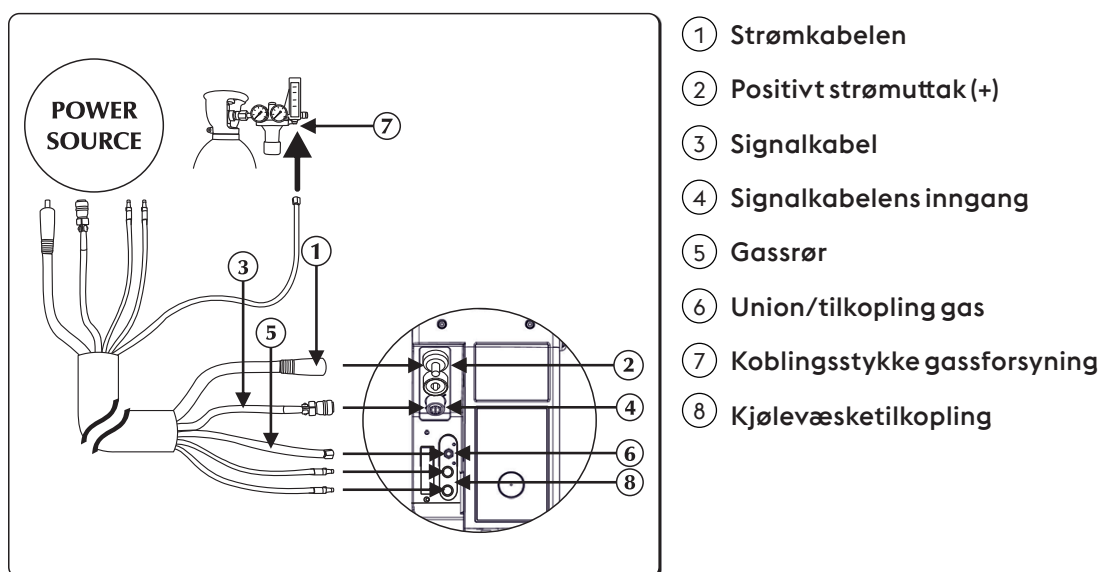
2.4.1 Kopling for MIG/MAG-sveising



- ▶ Kople strømkabelen til korrekt uttak. Sett inn kontakten og drei den med klokken til delene er helt sikret.
- ▶ Kople signalkabelen til korrekt kontakt. Sett i konnektoren og drei ringmutteren medurs til delen er skikkelig fast.
- ▶ Kople gasslangen til beholderens trykkreduksjonsventil eller til gassforsyningen. Reguler gassflyten mellom 10 til 30 l/min.
- ▶ Kople vannslangen (blå farge) til hurtigkoplingsuttaket (blå farge ) på kjøleenheten.
- ▶ Kople vannslangen (rød farge) til hurtigkoplings (rød farge ) inntak på kjøleenheten.
- ▶ Kopl CAN-BUS signalkabel for kontroll av eksternt utstyr (slik som RC, RI...) til angjeldende konnektor.

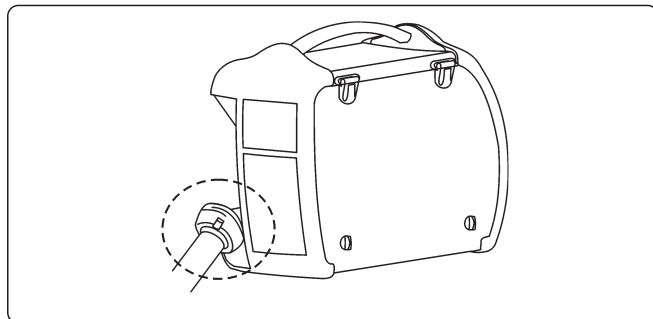

Se avsnittet "Installasjon tilbehør".

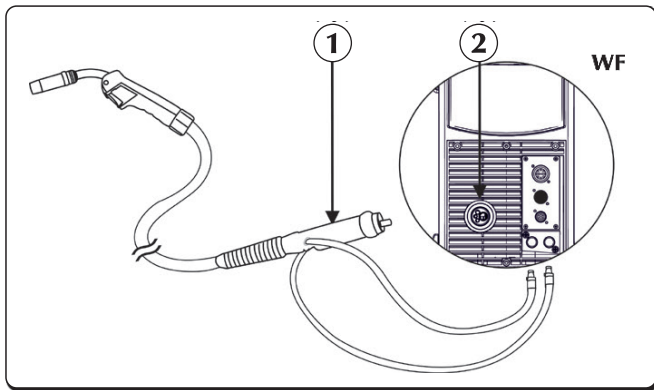

- ① Sveisebrennerens feste
- ② Kontakt

- ▶ Kople vannslangen fra sveisebrenneren (rød farge) til hurtigkoplings (rød farge) inntak på kjøleenheten.
- ▶ Kople vannslangen fra sveisebrenneren (blå farge) til hurtigkoplings (blå farge) uttak på kjøleenheten.
- ▶ Kople MIG/MAG-brenneren til sentraladapteren, og vær meget nøye med å skru festeringen helt fast.

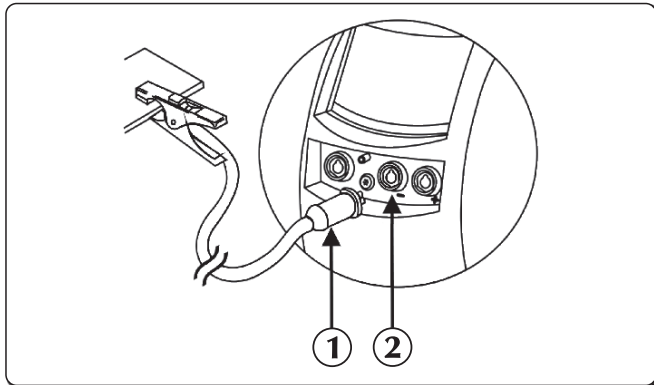

- ① Jordklemmekontakt
- ② Negativt strømuttak (-)

- ▶ Kopl jordklemmen til den negative sokkelen (-) på strømkilden. Sett inn kontakten og drei den med klokken til delene er helt sikret.

Motorrom

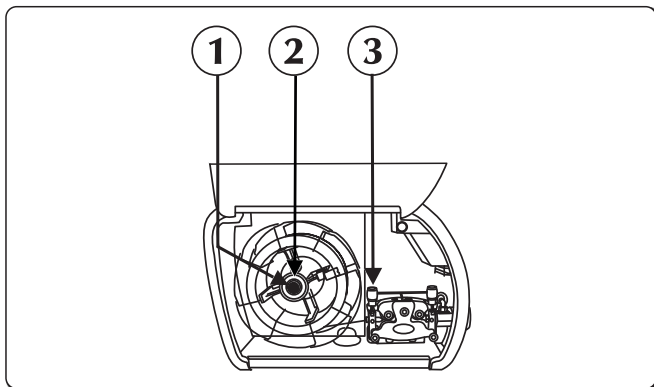

- ① Metallringen
- ② Friksjonsskruen
- ③ Trådmaterens trekkestøtte

- ▶ Åpne høyre sidedeksel.
- ▶ Kontroller at valsens åpning tilsvarer diameteren på tråden du skal bruke.
- ▶ Skru løs metallringen fra spindelen og sett in spolen.
- ▶ Sett også inn spolepinnen, sett inn spolen, installer festeringen i korrekt stilling og reguler friksjonsskruen.
- ▶ Løsne trådmaterens trekkestøtte ved å sette inn kabelens ende i bøssingen og la den passere på valsens i sveisebrennerens feste. Lås trekkestøtten i korrekt posisjon og kontroller at kabelen er i valsens åpninger.
- ▶ Trykk på tasten for trådforsyning for å lade tråden i sveisebrenneren.
- ▶ Reguler gassflyten mellom 10 til 30 l/min.

3. PRESENTASJON AV ANLEGGET

3.1 Bakpanel

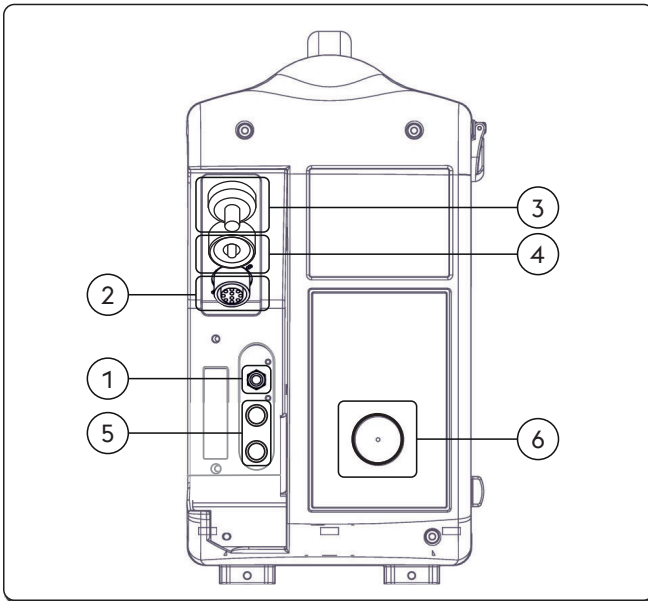

- ① Gassfeste
- ② Inngang signalkabel (CAN-BUS) (Kabelbunt)
- ③ Inngang effektkabel (Kabelbunt)
- ④ Positivt strømuttak (+)
- ⑤ Kjølevæske inntak/uttak
- ⑥ Tråd inngang



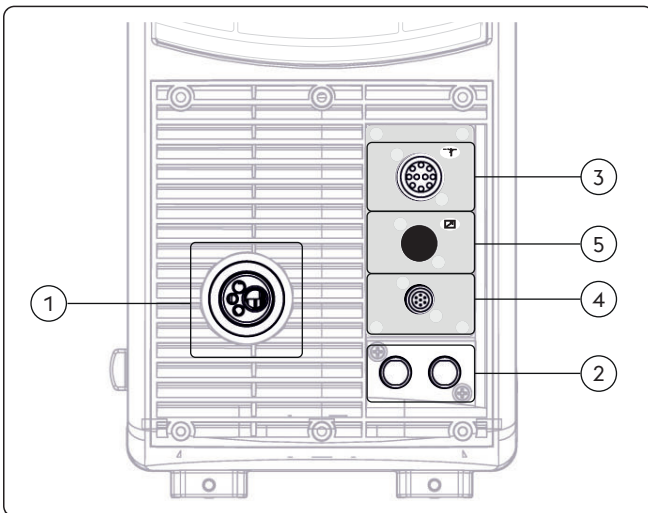



3.2 Støpselpanel

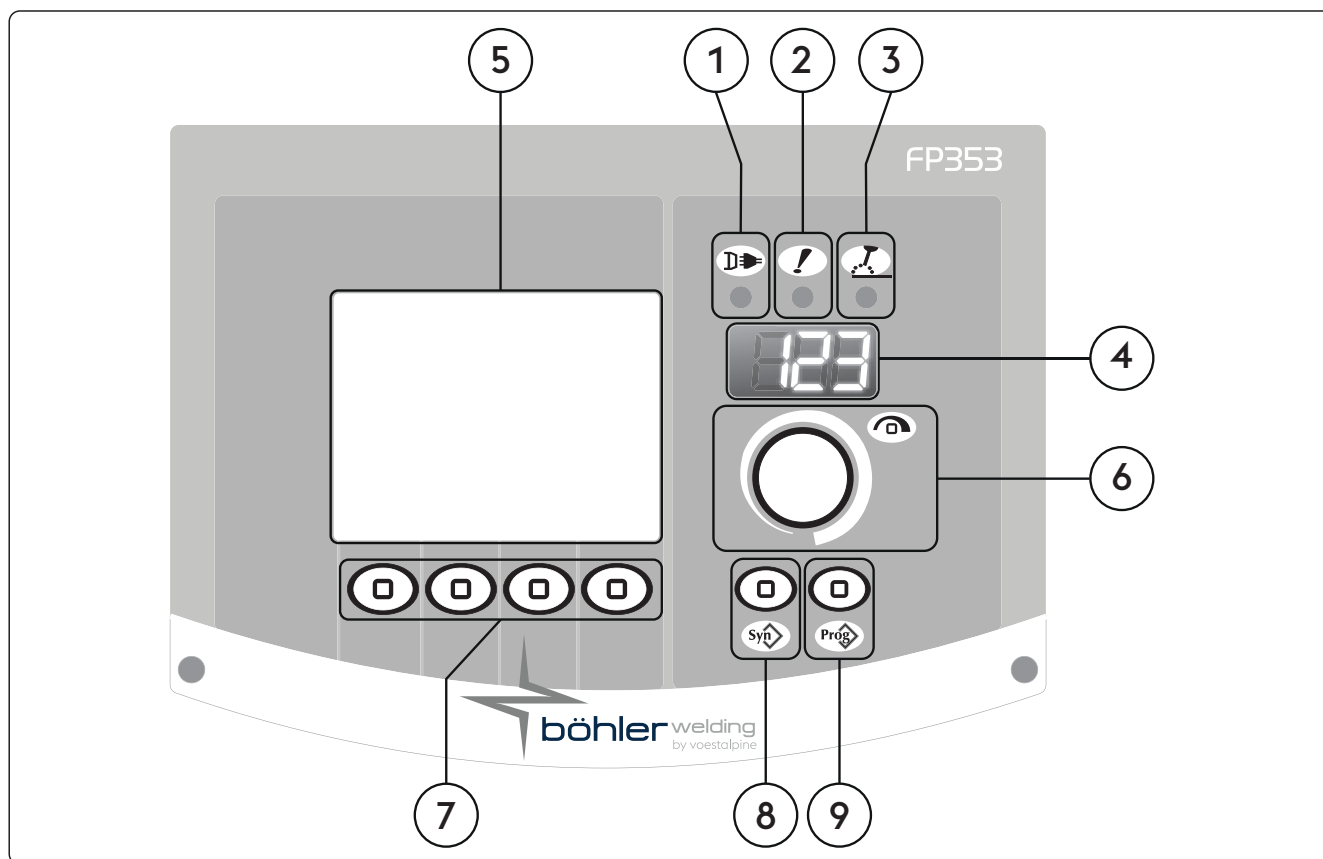

- ① Sveisebrennerens feste
For kopling av MIG/MAG-brenner.
- ② Kjølevæsketilkopling
- ③ Signalkabelens inngang (Push-Pull)
- ④ Inngang signalkabel (sveisebrenner)
Tilkobling av sveisebrenner
- ⑤ Signalkabel (RC) inngang

3.3 Frontpanel med kontroller



- 1  **LED for strømtilførsel**
Viser at utstyret er tilkoplett nettet og er på.
- 2  **LED for generell alarm**
Indikerer mulig påvirkning av en beskyttelsesenhet så som temperaturbeskyttelse.
- 3  **LED for aktivert effekt**
Indikerer at det er spenning på utstyrets spenningsuttak.
- 4  **7-segment skjerm**
Viser de generelle sveisemaskinparametrene under oppstart, settinger, strøm og spenningsverdier under sveising, og koding av alarmer.
- 5  **LCD skjerm**
Viser de generelle sveisemaskinparametrene under oppstart, settinger, strøm og spenningsverdier under sveising, og koding av alarmer.
Tillater alle operasjoner å bli vist øyeblikkelig.
- 6  **Hovedjusteringshendelen**
Tillater å tilføre oppsett, valg og setting av sveiseparameter.
- 7  **Funksjonsknapp**
Lar deg velge forskjellige systemfunksjoner:
- Sveiseprosess
- Sveisemetoder
- Strømpulsing
- Grafisk metode

8  **Knapp for sveiseprogram**

Lar deg velge et presatt sveiseprogram ved å velge noen få enkle settinger:

- Trådtype
- Type gass
- Tråddiameter

9  **Job-tast**

4. BRUK AV UTSTYRET

4.1 Startskjerm

Når den slås på, utfører generatoren en rekke kontroller for å garantere korrekt operasjon av systemet og av alt utstyret som er tilkopleet den. På dette trinn utføres også gasstesten for å sjekke riktig tilkoping til gassforsyningssystemet.

4.2 Testskjerm

Når sidepanelet (spolerrommet) er åpent, er sveiseoperasjonene forhindret fra kjøring. Testskjermen fremstår på LCD-skjermen.

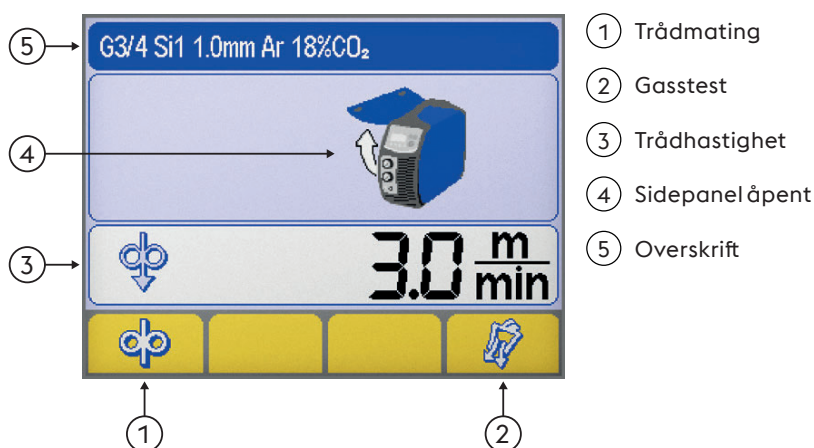

① Trådmating

② Gasstest

③ Tråd hastighet

④ Sidepanel åpent

⑤ Overskrift

Trådmating

Muliggjør manuell trådmating uten gassflyt og uten tråd innsatt. Tillater innføring av tråd i brennerkappen under forberedelsesfasen for sveising.

Gasstest

Lar gasskretsen bli rensset for urenheter, og utføring av justering av passende innledende trykk på gasstrykk og flyt, uten spenning på.

Tråd hastighet

Tillater regulering av matehastigheten for tråden (under lasting trinnet).

Minimum	Maksimum	Standard
0.5 m/min	22.0 m/min	3.0 m/min

Sidepanel åpent

Overskrift

Gir visning av visse deler av viktig informasjon relatert til den valgte prosess.

4.3 Hovedskjerm

Tillater kontroll av systemet og av sveiseprosessen ved å vise hovedsettingene.

4.4 Hovedskjerm bilde MIG/MAG-prosess

Standard skjerm bilde

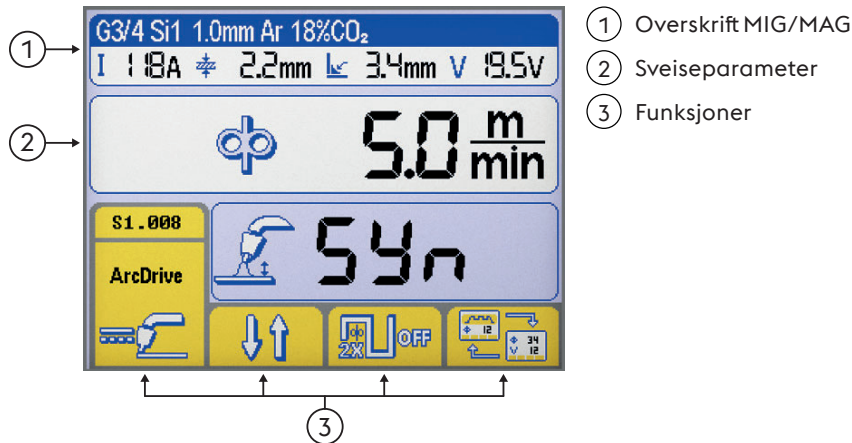

Grafisk skjerm bilde

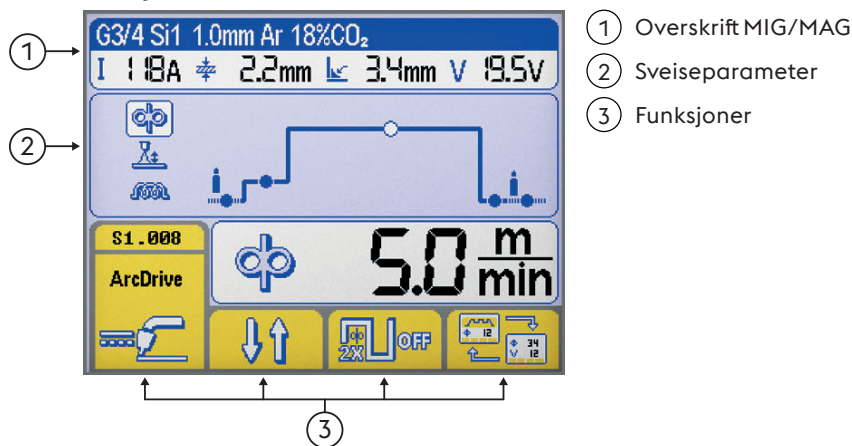

Overskrift MIG/MAG

Gir visning av visse deler av viktig informasjon relatert til den valgte prosess.

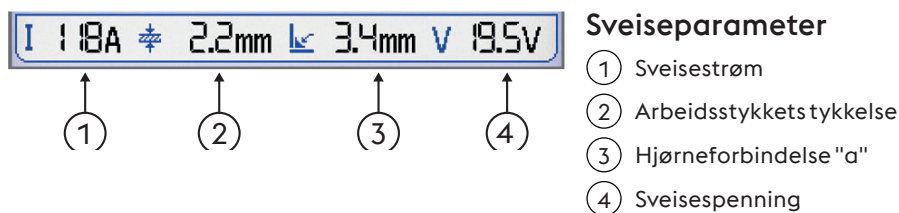

Sveiseparameter (Standard skjerm bilde)

► Velg det ønskede parameter ved å trykke på encoderknappen.

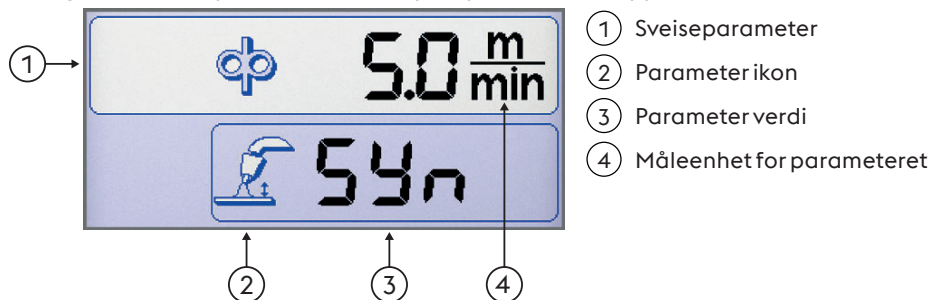

Sveiseparameter (Grafisk skjermbilde)

► Velg det ønskede parameter ved å trykke på encoderknappen.

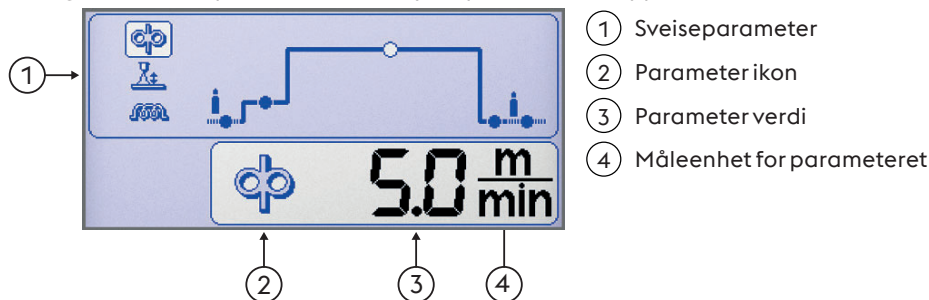

- ① Sveiseparameter
- ② Parameter ikon
- ③ Parameter verdi
- ④ Måleenhet for parameteret

Funksjoner

Tillater setting av de mest viktige prosessfunksjonene og sveisemetoder.

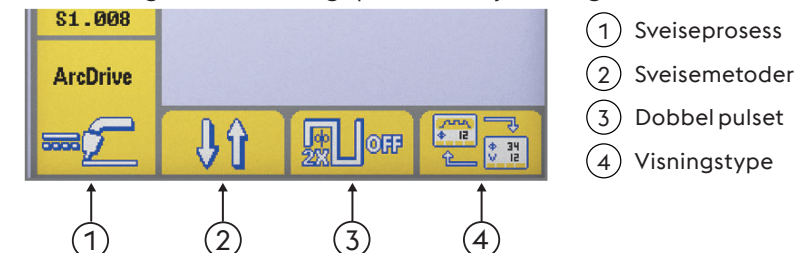

- ① Sveiseprosess
- ② Sveisemetoder
- ③ Dobbel pulset
- ④ Visningstype



Sveisemetoder

Gir valg av sveisemetoden



2 Trinn

I to trinn, trykke knappen får gassen til å strømme, mater spenning til tråden og får den til å trekkes frem; når den slippes, stenges gassen, spenningen og trådmatingen slås av.



4 Trinn

I fire trinn, første trykk på knappen får gassen til å strømme med en manuell pre-gasstid; slippe den aktiverer spenningen til tråden og dens mating. Påfølgende trykk på knappen stopper tråden og starter sluttprosessen, som bringer strømmen tilbake til null; ved da å slippe knappen stenges gassflyten.



Crater filler

Lar sveising bli gjort med tre forskjellige effektnivå som kan velges direkte og kontrollert av sveiseren ved bruk av brennerknappen.

Første trykk på knappen får gassen til å strømme, aktiverer spenning til tråden og mater den med en hastighet satt med parameteret "initielt inkrement" (under oppsettet) og med de relative synergiverdiene a sveiseparametrene.

Når brennerknappen slippes, endres trådhastigheten og de relative synergiparametrene automatisk til hovedverdiene satt på kontrollpanelet.

Neste trykk på brennerknappen bringer trådhastigheten og de relative synergiparametrene til de pre-satte (under oppsettet) kraterfyller parameterverdiene.

Ved å slippe brennerknappen stopper trådmatingen og forsyner effekt for burn back og etter-gass trinnene.



Dobbel pulset



Dobbel pulset aktivert



Dobbel pulset ikke aktivert

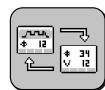

Visningstype

Tillater endringen av visning mellom:



Standard skjermbilde



Grafisk skjermbilde

Skjermen synergikurver





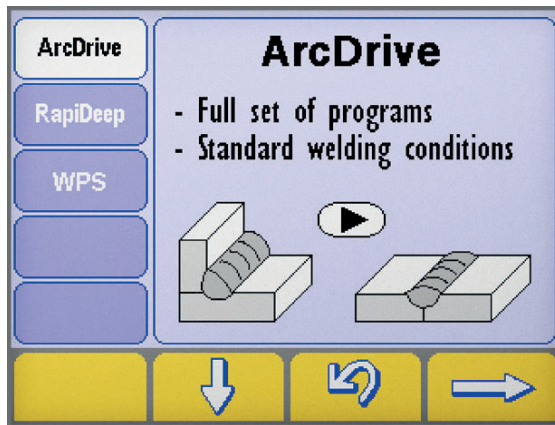

Synergi

Lar deg velge et presatt sveiseprogram (synergi) ved å velge noen få enkle settinger

Valg av sveiseprosess



- ▶ Gå inn i skjermbildet "synergi" og trykk på knappen  i minst ett sekund.
- ▶ Velg ønsket sveiseprosess ved å trykke på  e 
- ▶ Trykk på knappen  for å gå til neste trinn.



Skjermbilde for valg av synergi Materialtype/gasstype

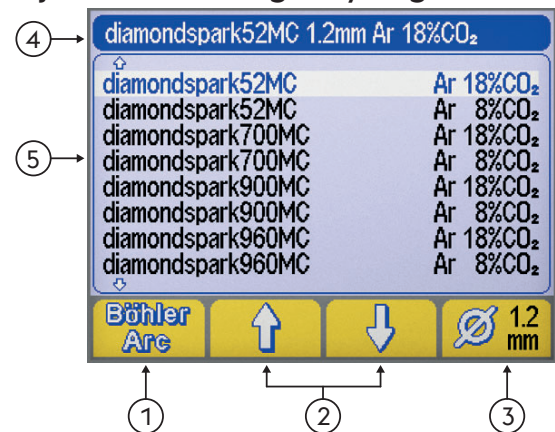

- 1 Sveiseprogram (BöhlerArc/UniversalArc)
- 2 Valg av materiale/gass
- 3 Tråddiameter
- 4 Overskrift
- 5 Sveiseprogram

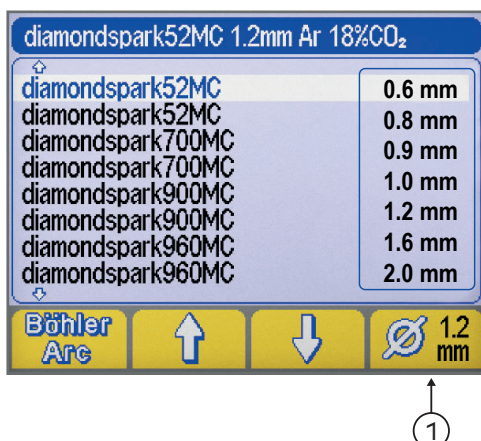

- 1 Tråddiameter

Overskrift

Gir visning av visse deler av viktig informasjon relatert til den valgte prosess.

NO PROGRAM

Indikerer at det valgte synergiprogrammet ikke er tilgjengelig, eller passer ikke med de andre systemsettingene.

5. INNSTILLING

5.1 Oppsett og innstillinger av parametrene

Muliggjør innstilling og regulering av en serie ekstre parameter for en bedre og mer eksakt håndtering av sveiseanlegget. Parametrene som er inkludert i innstillingen er organisert i samsvar med den sveiseprosessen du har valgt og har et kodenummer.

For å utføre innstillingsprosedyren



- ▶ Utføres ved å trykke på encoder-knappen i 5 sekunder.
- ▶ Tilgangen bekreftes av teksten 0 på displayet.

Valg og regulering av ønsket parameter

- ▶ Skjer ved å dreie kodeenheten til den viser kodenumeret som gjelder ønsket parameter.
- ▶ Hvis du trykker på enkodertasten, kan du få vist innstilt verdi for valgt parameter og dens regulering.

For å gå ut fra innstillingsmodus

- ▶ For å gå ut fra seksjonen "regulering", skal du trykke på enkodertasten igjen.
- ▶ For å gå ut fra innstillingsmodus, kan du stille deg på parameter "0" (lagre og gå ut) og trykke på enkodertasten.
- ▶ Bekreft operasjonen ved å trykke knappen .
- ▶ For å lagre endringen og gå ut av set up, trykk på: .

5.1.1 Liste med parametere for innstilling (MMA)

0 Lagre og gå ut



For å lagre endringene og gå ut fra innstillingsmodus.

1 Reset



For å tilbakestille alle standard parametrene.

3 Hot start



Muliggjør regulering av verdien for hot start i MMA.

Tillater en oppstart som er mer eller mindre "varm" i fasene for buens aktivering, for å lette oppstart.

Basisk elektrode

Minimum	Maksimum	Standard
0/av	500%	80%

Cellulose elektrode

Minimum	Maksimum	Standard
0/av	500%	150%

CrNi elektrode

Minimum	Maksimum	Standard
0/av	500%	100%

Aluminiums elektrode

Minimum	Maksimum	Standard
0/av	500%	120%

Støpejerns elektrode

Minimum	Maksimum	Standard
0/av	500%	100%

7

Sveisestrøm

For regulering av sveisestrømmen.



Minimum	Maksimum	Standard
3 A	I _{max}	100 A

8

Arc force

For å regulere verdien Arc force i MMA.



Gjør at du oppnår dynamiske svar som er mer eller mindre energisk under sveisingen, for å lette sveiserens arbeid. Økning av verdien på buen medfører reduksjon av risikoen for klebing av elektroden.

Basiskelektrode

Minimum	Maksimum	Standard
0/av	500%	30%

Cellulose elektrode

Minimum	Maksimum	Standard
0/av	500%	350%

CrNi elektrode

Minimum	Maksimum	Standard
0/av	500%	30%

Aluminiums elektrode

Minimum	Maksimum	Standard
0/av	500%	100%

Støpejernselektrode

Minimum	Maksimum	Standard
0/av	500%	70%

204

Dynamic power control (DPC)

Det aktiverer valget av den ønskede V/I karakteristikk.



I=C Konstant strøm

Økning eller reduksjon av buehøyde har ingen effekt på nødvendig sveisestrøm.

Anbefalt for elektrode: Basisk, Rutil, Syre, Stål, Støpjern

1:20 Reduksjon av kontroll på stigningsforhold

Økning i buehøyde gir en reduksjon i sveisestrøm (og vice versa) i henhold til verdien lagt inn med 1 til 20 A per volt.

Anbefalt for elektrode: Cellulose, Aluminium

P=C Konstant effekt

Økning i buehøyden gir en reduksjon i sveisestrømmen (og vice versa) i henhold til loven: $V \cdot I = K$

Anbefalt for elektrode: Cellulose, Aluminium

312

Spenning for buefjerning

Gjør at du kan stille inn spenningsverdien som skal brukes for å slokke den elektriske buen.



For en bedre håndtering av de ulike funksjonsbetingelsene som oppstår.

Under punktveisingen for eksempel, gjør en lav buespenning at gnisten blir mindre når du flytter elektroden fra stykket, og dette minker sprut, brenning og oksidering av stykket.

Hvis du bruker elektroder som trenger høy spenning, anbefaler vi deg å stille inn en høy verdi for å unngå at buen slukker under sveisingen.



Still aldri inn en spenning for fjerning av buen som overstiger generatorens tomgangsspenning.

Basiskelektrode

Minimum	Maksimum	Standard
0/av	99.9 V	57.0 V

Cellulose elektrode

Minimum	Maksimum	Standard
0/av	99.9 V	70.0 V

399

Tillater visningen av skjærehastighet.

Lar deg sette sveisehastighet.



Default cm/min: referansehastighet for manuell sveising.

Syn: Sinergic verdi.

Minimum	Maksimum	Standard
1 cm/min	200 cm/min	15 cm/min

500 Innstilling av maskin

Tillater valg av det nødvendige grafiske grensesnitt.
 Gir tilgang til høyere oppsettnivåer.
 Konsulter seksjon "Grensesnitt personalisering (Set up 500)"

Verdi	Bruker grensesnitt	Verdi	Valgt nivå
XE	Easy-modus	USER	Bruker
XA	Avansert-modus	SERV	Service
XP	Profesjonell-modus	vaBW	vaBW

551 Lock/unlock

Tillater låsing av panelkontrollene og innsettingen av en beskyttelseskode.
 Konsulter seksjon "Lock/unlock (Set up 551)".

552 Akustisk signal

For regulering av lyden på det akustiske signalet.

Minimum	Maksimum	Standard
0/av	10	10

601 Reguleringsstepp

Tillater reguleringen av et parameter med et stepp som kan bli personalisert av operatøren.

Minimum	Maksimum	Standard
1	Imax	1

602 Eksternt parameter CH1, CH2, CH3, CH4

Tillater administrasjon av det eksterne parameter 1, 2, 3, 4 (minimum verdi, maksimum verdi, standard verdi, parameter valgt).

Konsulter seksjon "Ekstern kontrolladministrasjon (Set up 602)".

705 Kalibrering kretsmotstand

Tillater kalibrering av anlegget.

Konsulter seksjon "Kalibrering kretsmotstand (set up 705)".

751 Strømvlesing

Tillater visning av den reelle verdien av sveisestrømmen.

752 Spenningsavlesing

Tillater visning av den reelle verdien av sveisespenningen.

768 Måling varmetilførsel HI

Tillater avlesning av måleverdien for varmetilførselen ved sveising.

801 Vaktgrenser

Muliggjør setting av varselgrenser og av vaktgrenser.

Lar sveiseprosessen bli kontrollert ved å sette varselgrenser og vaktgrenser for de målbare hoved- parameter.

Tillater nøyaktig kontroll av de forskjellige sveisefaser.

Konsulter seksjon "Vaktgrenser (Set up 801)".

5.1.2 Liste over setup-parametere (TIG)
0 Lagre og gå ut

For å lagre endringene og gå ut fra innstillingsmodus.

NO

1 Reset



For å tilbakestille alle standard parametrene.

7 Sveisestrøm



For regulering av sveisestrømmen.

Minimum	Maksimum	Standard
3 A	I _{max}	100 A

399 Tillater visningen av skjærehastighet.



Lar deg sette sveisehastighet.
Default cm/min: referansehastighet for manuell sveising.
Syn: Sinergic verdi.

Minimum	Maksimum	Standard
1 cm/min	200 cm/min	10 cm/min

500 Innstilling av maskin



Tillater valg av det nødvendige grafiske grensesnitt.
Gir tilgang til høyere oppsettnivåer.
Konsulter seksjon "Grensesnitt personalisering (Set up 500)"

Verdi	Brukergrensesnitt
XE	Easy-modus
XA	Avansert-modus
XP	Profesjonell-modus

Verdi	Valgt nivå
USER	Bruker
SERV	Service
vaBW	vaBW

551 Lock/unlock



Tillater låsing av panelkontrollene og innsettingen av en beskyttelseskode.
Konsulter seksjon "Lock/unlock (Set up 551)".

552 Akustisk signal



For regulering av lyden på det akustiske signalet.

Minimum	Maksimum	Standard
0/av	10	10

601 Reguleringsstepp



Tillater reguleringen av et parameter med et stepp som kan bli personalisert av operatøren.

Minimum	Maksimum	Standard
1	I _{max}	1

602 Eksternt parameter CH1, CH2, CH3, CH4



Tillater administrasjon av det eksterne parameter 1, 2, 3, 4 (minimum verdi, maksimum verdi, standard verdi, parameter valgt).
Konsulter seksjon "Ekstern kontrolladministrasjon (Set up 602)".

705 Kalibrering kretsmotstand



Tillater kalibrering av anlegget.
Konsulter seksjon "Kalibrering kretsmotstand (set up 705)".

751 Strømvlesing



Tillater visning av den reelle verdien av sveisestrømmen.

752 Spenningsavlesing



Tillater visning av den reelle verdien av sveisespenningen.

NO

758
Robot bevegeseshastighet

Muliggjør visning av bevegeseshastigheten på armen av en robot eller en automasjonsenhet.

768
Måling varmetilførsel HI

Tillater avlesning av måleverdien for varmetilførselen ved sveising.

801
Vaktgrenser

Muliggjør setting av varselgrenser og av vaktgrenser.

Lar sveiseprosessen bli kontrollert ved å sette varselgrenser og vaktgrenser for de målbare hoved- parameter.

Tillater nøyaktig kontroll av de forskjellige sveisefaser.

Konsulter seksjon "Vaktgrenser (Set up 801)".

5.1.3 Liste over setup-parametere (MIG/MAG)
0
Lagre og gå ut

For å lagre endringene og gå ut fra innstillingsmodus.

1
Reset

For å tilbakestille alle standard parametrene.

2
Sveiseprogram

MIG/MAG Standard:

 Muliggjør valg av den manuelle MIG ( Off) eller synergisk MIG-prosess ( 6) ved å sette typen material som skal sveises.

Pulset MIG/MAG:

 Muliggjør valg av den synergisk MIG-prosess ( 6) ved å sette typen material som skal sveises.
 Muliggjør valg av den CC/CV-prosess.

3
Trådhastighet

Tillater regulering av matehastigheten for tråden.

Minimum	Maksimum	Standard
0.5 m/min	22.0 m/min	-

4
Strøm

For regulering av sveisestrømmen.

Minimum	Maksimum
3 A	I _{max}

5
Arbeidsstykkets tykkelse

Tillater setting av tykkelsen på delen som sveises.

Tillater setting av systemet via regulering av delen som sveises.

6
Hjørneforbindelse "a"

Lar deg sette forbindelsesdybden i et hjørnepunkt.

10
Pre gass

For å stille inn og regulere gassflyten før buen blir aktivert.

Muliggjør fylling av gass i sveisebrenneren og forberedemiljøet for sveiseprosedyren.

Minimum	Maksimum	Standard
0/av	99.9 s	0.1 s



11 Soft start

For å regulere trådens matehastighet i fasene før aktiveringen.
For en aktivering med redusert hastighet og mykere oppstart med mindre sprut.

Minimum	Maksimum	Standard
10 %	100 %	50 %



12 Motorens ramp

Muliggjør innstilling av en gradert overgang mellom trådens aktiveringshastighet og sveisehastigheten.

Minimum	Maksimum	Standard
0/av	1.0 s	0/av

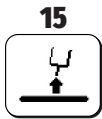

15 Burn back

Muliggjør regulering av trådens brennetid for å forhindre klebing ved sveiseprosedyrens slutt.
Muliggjør reguleringen av trådens lengde utenfor sveisebrenneren.

Minimum	Maksimum	Standard
-2.00	+2.00	0/syn



16 Ettergass

For regulering av gassflyten ved sveisingens slutt.

Minimum	Maksimum	Standard
0/av	99.9 s	2.0 s

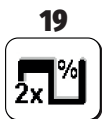

19 Duty cycle (Dobbel pulset)

Gjør det mulig å sette tiden hvorfra sluttstrømmen bibeholdes.

Minimum	Maksimum	Standard
10 %	90 %	50 %



20 Dobbel pulset

Tillater regulering av pulseringens amplitude.

Minimum	Maksimum	Standard
0 %	100 %	±25 %

Minimum	Maksimum	Standard
0.5 m/min	22 m/min	2.5 m/min

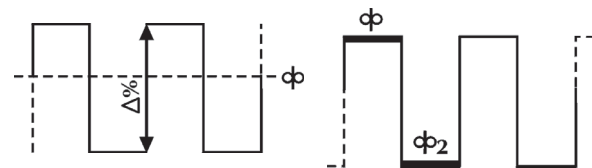

21 Puls frekvens (Dobbel pulset)

Tillater regulering av takten, d.e. av impulsens repetisjonstakt.
Tillater impulsfrekvensen å bli regulert.

Minimum	Maksimum	Standard
0.1 Hz	5.0 Hz	2.0 Hz

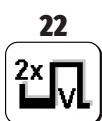

22 Sekundær spenning (Dobbel pulset)

Tillater regulering av det sekundære pulserings spenningsnivå.
Gjør det mulig å oppnå større buestabilitet under de forskjellige pulseringsfaser.

Minimum	Maksimum	Standard
-5.0	+5.0	0/syn



23 Pulset helling (Dobbel pulset)

Tillater setting av stigetid under pulsoperasjonen.

Minimum	Maksimum	Standard
1 %	100 %	50 %

NO

24 Bilevel (4T - crater filler)

For regulering av sekundærtrådhastighet i modus for binivå-sveising.

Hvis sveiserarbeideren trykker og siden hurtig slipper knappen, overgår enheten til " ϕ_2 ".

Hvis han trykker og hastig slipper knappen igjen, overgår enheten igjen til " ϕ " osv.

Minimum	Maksimum	Standard
1 %	200 %	0/av

25 Startinkrement

Tillater regulering av verdien på trådhastigheten under den første "krater-fyller" sveisefase.

Gjør det mulig å øke energien tilført delen under fasen når materialet (fortsett kaldt) trenger mere varme for å smelte jevnt.

Minimum	Maksimum	Standard
20 %	200 %	120 %

26 Crater filler

Tillater regulering av verdien på trådhastigheten under sveisens slutfase.

Gjør det mulig å redusere energien tilført delen under fasen når materialet allerede er meget varmt, og således redusere risikoen for uønsket deformeringer.

Minimum	Maksimum	Standard
20 %	200 %	80 %

27 Start inkrementtid

Lar deg sette start inkrementtid.

Automatiserer "kraterfyller"-funksjonen.

Minimum	Maksimum	Standard
0.1 s	99.9 s	0/av

28 Kraterfyller tid

Lar deg sette "kraterfyller" tid.

Automatiserer "kraterfyller"-funksjonen.

Minimum	Maksimum	Standard
0.1 s	99.9 s	0/av

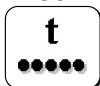
30 Punktveising

Lar deg aktivere "punktveising"-prosessen og sette opp sveisetid.

Minimum	Maksimum	Standard
0.1 s	99.9 s	0/av

31 Pausepunkt

Muliggjør aktiveringen av prosessen "pausepunkt" og beregning av pausetiden mellom en sveisesyklus og en annen.

Minimum	Maksimum	Standard
0.1 s	99.9 s	0/av

32 Sekundær spenning (Binivå MIG)

Tillater regulering av det sekundære pulserings spenningsnivå.

Gjør det mulig å oppnå større buestabilitet under de forskjellige pulseringsfaser.

Minimum	Maksimum	Standard
-5.0	+5.0	0/syn

33 Sekundær induktans (Binivå MIG)

Tillater regulering av det sekundære pulserings induktans.

Gjør det mulig å oppnå en raskere eller saktere bue for å kompensere for sveiserens bevegelser og for den naturlige ustabilitet i sveising.

Lav induktans = reaktiv bue (mere sprut).

Høy induktans = mindre reaktiv bue (mindre sprut).

Minimum	Maksimum	Standard
-30	+30	0/syn

NO



34 Rampe for startinkrement

Brukes for å innstille en gradvis overgang mellom startinkrementet og sveisingen.

Minimum	Maksimum	Standard
0 s	10 s	0/av



35 Rampe for kraterfyller

Brukes for å innstille en gradvis overgang mellom sveisingen og kraterfylleren.

Minimum	Maksimum	Standard
0 s	10 s	0/av



202 Induktans

Tillater elektronisk regulering av serieinduktansen i sveisekretsen.

Gjør det mulig å oppnå en raskere eller saktere bue for å kompensere for sveiserens bevegelser og for den naturlige ustabilitet i sveising.

Lav induktans = reaktiv bue (mere sprut).

Høy induktans = mindre reaktiv bue (mindre sprut).

Minimum	Maksimum	Standard
-30	+30	0/syn



331 Kompensert gjennomsnittsspennning

Lar deg sette sveisespenning.



398 Referansekostant for forflyttingshastighet

Referansekostant for alle sveiseprosessene

Verdien til sveisebrennerens forflyttingshastighet som systemet bruker som referanse i beregningen av sveiseparameterene



399 Tillater visningen av skjærehastighet.

Lar deg sette sveisehastighet.

Default cm/min: referansehastighet for manuell sveising.

Syn: Sinergic verdi.

Minimum	Maksimum	Standard
syn min	syn max	35 cm/min



500 Innstilling av maskin

Tillater valg av det nødvendige grafiske grensesnitt.

Gir tilgang til høyere oppsettnivåer.

Konsulter seksjon "Grensesnitt personalisering (Set up 500)"

Verdi	Brukergrensesnitt
XE	Easy-modus
XA	Avansert-modus
XP	Profesjonell-modus

Verdi	Valgt nivå
USER	Bruker
SERV	Service
vaBW	vaBW



551 Lock/unlock

Tillater låsing av panelkontrollene og innsettingen av en beskyttelseskode.

Konsulter seksjon "Lock/unlock (Set up 551)".



552 Akustisk signal

For regulering av lyden på det akustiske signalet.

Minimum	Maksimum	Standard
0/av	10	10

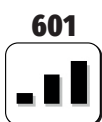

601 Reguleringsstepp

Tillater reguleringen av et parameter med et stepp som kan bli personalisert av operatøren.

Funksjonalitet styrt av knappen for fakkell opp / ned.

Minimum	Maksimum	Standard
1	Imax	1

602 Eksternt parameter CH1, CH2, CH3, CH4

Tillater administrasjon av det eksterne parameter 1, 2, 3, 4 (minimum verdi, maksimum verdi, standard verdi, parameter valgt).

Konsulter seksjon "Ekstern kontrolladministrasjon (Set up 602)".

606 U/D brenner

Tillater administrasjon av det eksterne parameter (U/D).

Verdi	Standard	Tilbakeringingsfunksjon
0/av	-	av
1/I1	X	Strøm
	-	Program henting

612 Setting sveisebrenner DgMig

Tillater å styre kanalene til den digitale sveisebrenneren.

Verdi	Standard	Tilbakeringingsfunksjon
0/av	-	av
1/I1	-	Strøm
2/ 	-	Program henting
3/CH3	-	CH3
4/CH4	-	CH4
5/STD	X	STD

653 Trådhastighet

Tillater regulering av matehastigheten for tråden (under lasting trinnet).

Minimum	Maksimum	Standard
0.5 m/min	22.0 m/min	3.0 m/min

705 Kalibrering kretsmotstand

Tillater kalibrering av anlegget.

Konsulter seksjon "Kalibrering kretsmotstand (set up 705)".

751 Strømvlesing

Tillater visning av den reelle verdien av sveisestrømmen.

752 Spenningsavlesing

Tillater visning av den reelle verdien av sveisepeningen.

755 Gassflyt lesing

Muliggjør visning av verdien på reell gassflyt.

757 Trådhastighet

Avlesing av encoder til motor 1.

758 Robot bevegelseshastighet

Muliggjør visning av bevegelseshastigheten på armen av en robot eller en automasjonsenhet.

760 Strømvlesing (motor 1)

Tillater visning av den reelle verdien av motorensstrømmen (motor 1).

768 Måling varmetilførsel HI



Tillater avlesning av måleverdien for varmetilførselen ved sveising.

770 Mål for avsatt materiale



Tillater visning av mål for avsatt materiale.

801 Vaktgrenser



Muliggjør setting av varselgrenser og av vaktgrenser. Lar sveiseprosessen bli kontrollert ved å sette varselgrenser og vaktgrenser for de målbare hoved- parameter. Tillater nøyaktig kontroll av de forskjellige sveisefaser. Konsulter seksjon "Vaktgrenser (Set up 801)".

5.2 Spesifikke prosedyrer for bruk av parameterene

5.2.1 Personalisering 7-segment visning

Tillater å hele tiden vise verdien til en parameter på 7-segment displayet.

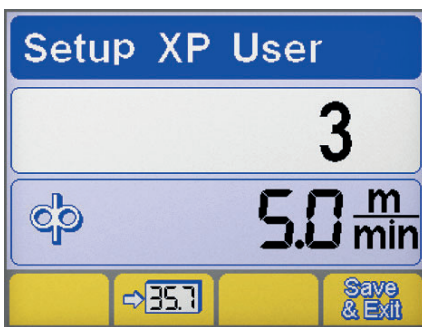

- ▶ Gå inn i oppsett ved å trykke encoderknappen i minst 5 sekunder.
- ▶ Velg ønsket parameter ved å dreie encodern.
- ▶ Lagre det valgte parameter i 7-segment visning ved å trykke knappen .
- ▶ Lagre og gå ut av nåværende skjerm ved å trykke knappen .

5.2.2 Grensesnitt personalisering (Set up 500)

Tillater parametrene å bli tilpasset på hovedmenyen.

500 Innstilling av maskin



Tillater valg av det nødvendige grafiske grensesnitt.

Verdi	Brukergrensesnitt
XE	Easy-modus
XA	Avansert-modus
XP	Profesjonell-modus

MODUS XE

MIG/MAG

Sveiseparameter

Funksjoner

MODUS XA

MIG/MAG

Sveiseparameter

Funksjoner

MODUS XP

MIG/MAG

Sveiseparameter												
Funksjoner												

5.2.3 Lock/unlock (Set up 551)

Tillater låsing av panelkontrollene og innsettingen av en beskyttelseskode.

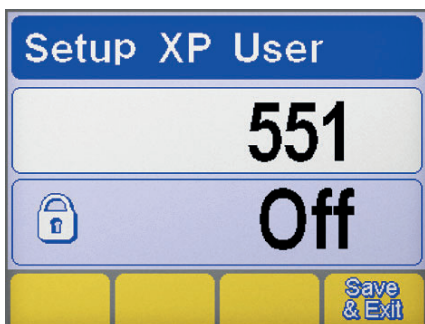
Valg av parameter

- ▶ Gå inn i oppsett ved å trykke encoderknappen i minst 5 sekunder.
- ▶ Velg det ønskete parameter (551).
- ▶ Aktiver reguleringen av det valgte parameter ved å trykke encoderknappen.

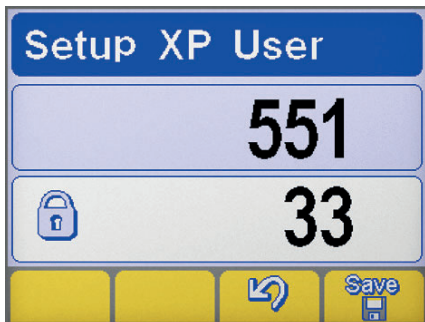
Passordinnstilling

- ▶ Sett en tallkode (passord) ved å dreie encodern.
- ▶ Trykk på encoder-knappen for å bekrefte oppgaven.
- ▶ Bekreft operasjonen ved å trykke knappen
- ▶ For å lagre endringen, trykk på:

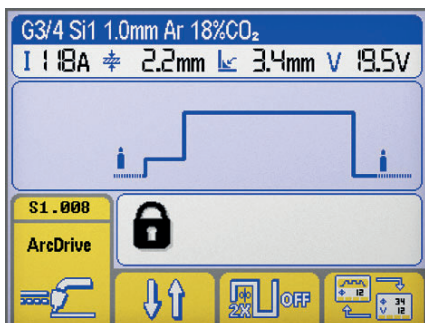
Panelfunksjoner

- ▶ Gå til panelfunksjonaliteter midlertidig (5 minutter) ved å dreie encodern og legg inn riktig passord.
- ▶ Trykk på encoder-knappen for å bekrefte oppgaven.
- ▶ Lås opp kontrollpanelet definitivt ved å gå inn i oppsett (følg instruksjonene gitt ovenfor) og bring parameter 551 tilbake til "av".
- ▶ Trykk på encoder-knappen for å bekrefte oppgaven.
- ▶ For å lagre endringen, trykk på:

5.2.4 Ekstern kontrolladministrasjon (Set up 602)

Tillater administrasjon av det eksterne parameter 2 (minimum verdi, maksimum verdi, standard verdi, parameter valgt).

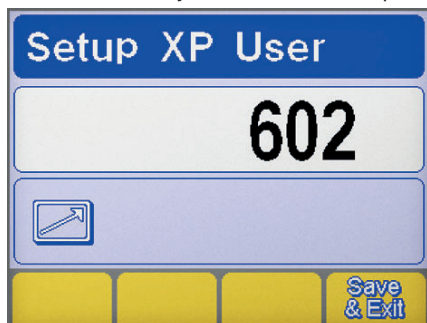
Valg av parameter

- ▶ Gå inn i oppsett ved å trykke encoderknappen i minst 5 sekunder.
- ▶ Velg det ønskete parameter (602).
- ▶ Gå inn i skjermen for "Ekstern kontrolladministrasjon" ved å trykke encoderknappen.

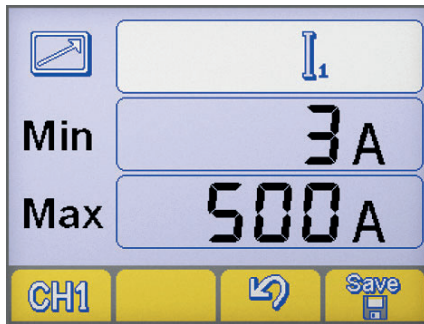

Ekstern kontrolladministrasjon

- ▶ Velg den ønskete RC fjernkontroll utgang (CH1, CH2, CH3, CH4) ved å trykke knapp.
- ▶ Velg ønsket parameter (Min-Max-parameter) ved å trykke encoderknappen.
- ▶ Juster ønsket parameter (Min-Max-parameter) ved å dreie encoderen.
- ▶ For å lagre endringen, trykk på:
- ▶ Bekreft operasjonen ved å trykke knappen

5.2.5 Kalibrering kretsmotstand (set up 705)

Tillater å kalibrere generatoren på varmelementet til den aktuelle sveisekretsen.

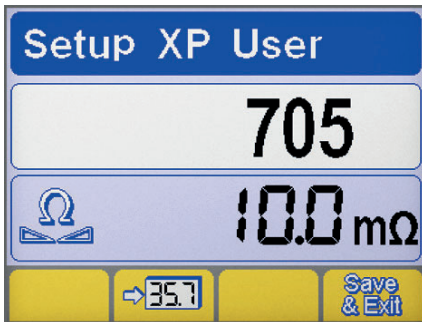

Valg av parameter

- ▶ Gå inn i oppsett ved å trykke encoderknappen i minst 5 sekunder.
- ▶ Velg det ønskete parameter (705).
- ▶ Aktiver reguleringen av det valgte parameter ved å trykke encoderknappen.
- ▶ Koble generatoren til sveisekretsen (benk eller arbeidsstykke).
- ▶ Ta av hetten for å sette på dyseholderspissen på sveisebrenneren. (MIG/MAG)

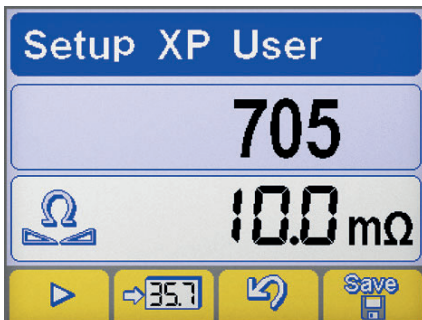

Kalibrasjon

- ▶ Plasser tuppen av strådstyringen i elektrisk kontakt med arbeidsstykket. (MIG/MAG)
- ▶ Trykk på knappen for å starte prosedyren.
- ▶ Opprett kontakten i minst ett sekund.
- ▶ Verdien vist på displayet oppdateres ved avsluttet kalibrering.
- ▶ Bekreft operasjonen ved å trykke knappen .
- ▶ Bekreft operasjonen ved å trykke knappen .
- ▶ For å lagre endringen og gå ut av set up, trykk på: .

5.2.6 Vaktgrenser (Set up 801)

Muliggjør setting av varselgrenser og av vaktgrenser.

Lar sveiseprosessen bli kontrollert ved å sette varselgrenser og vaktgrenser for de målbare hoved- parameter.

Tillater nøyaktig kontroll av de forskjellige sveisefaser.

Konsulter seksjon "Vaktgrenser (Set up 801)".

Varselerskel				Vaktgrenser			
	Sveisestrøm				Sveisespenning		
	Gassflyt lesing				Robot bevegelseshastighet		
	Strømvalesing (motor 1)				Strømvalesing (motor 2)		
	Avlesing av kjølevæskeflyt				Tråd hastighet		
	Kjølevæsketemperatur lesing						

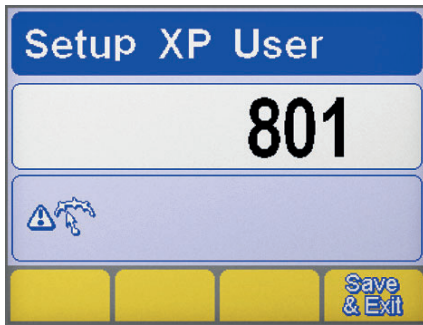
Valg av parameter

- ▶ Gå inn i oppsett ved å trykke encoderknappen i minst 5 sekunder.
- ▶ Velg det ønskete parameter (801).
- ▶ Gå inn i skjermen "Vaktgrense" ved å trykke encoderknappen.

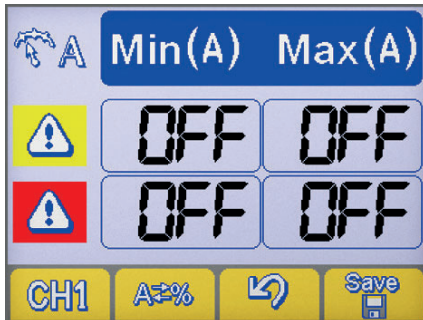
Valg av parameteren

- ▶ Velg ønsket parameter ved å trykke knappen **CH1**.
- ▶ Velg metoden for setting av vaktgrenser ved å trykke knappen **A≠%**.

Innstilling av maskin

Absolutt verdi

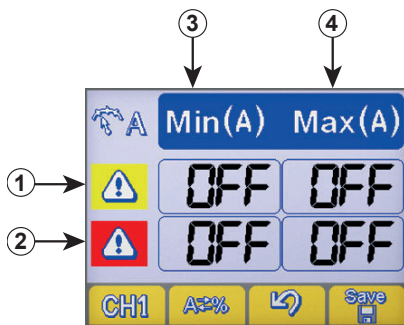

Prosentverdi

Innstilling av sikkerhetsteskler

- 1 Varselgrense linje
- 2 Alarmgrense linje
- 3 Minimum nivå kolonne
- 4 Maksimum nivå kolonne

- ▶ Velg ønsket boks ved å trykke encoderknappen (den valgte boks vises med omvendt kontrast).
- ▶ Juster nivået på den valgte grense ved å dreie encoderen.
- ▶ For å lagre endringen, trykk på: **Save**.



Passering en av varselgrensene medfører at et visuelt signal fremkommer på kontrollpanelet.



Passering en av alarmgrensene medfører at et visuelt signal fremkommer på kontrollpanelet og øyeblikkelig blokkering av sveiseoperasjonene.

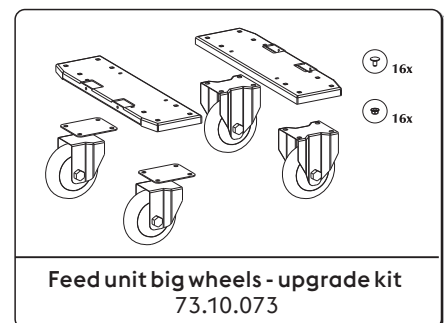
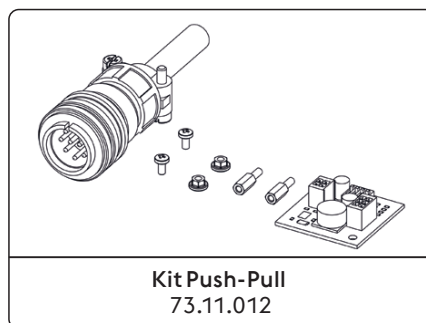
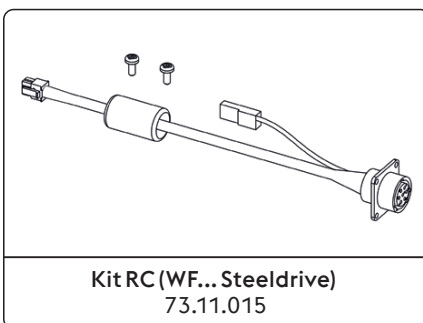

Det er mulig å sette start og slutt på sveise filtrene for å unngå feilsignaler under tenning og slokking av buen (konsulter seksjon "Oppsett" - Parameter 802-803-804).

6. TILBEHØRSSETT

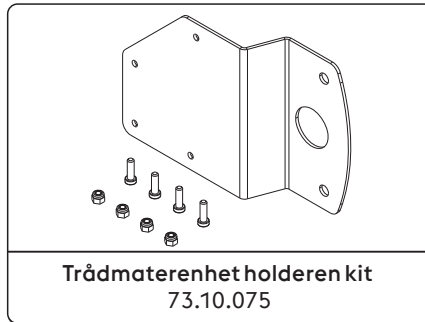
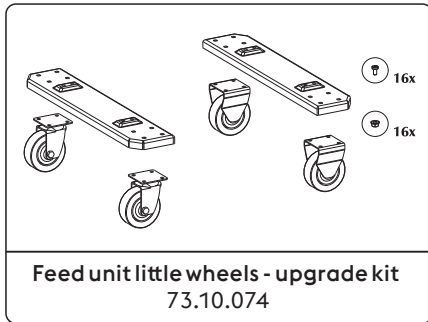

*Fabrikk montering

Konsulter seksjonen "Installasjon kit/tilbehørssett".

7. VEDLIKEHOLD



Du må utføre rutinemessig vedlikehold på anlegget i samsvar med fabrikantens instruksjoner. Alle adgangsører, vedlikeholdsører og deksel må være lukket og sitte godt fast når utstyret er igang. Du skal ikke utføre endringer på anlegget. Unngå at det hopper seg opp metallstøv nær eller på selve lufteribbene.



Alt vedlikeholdsarbeid må utføres kun av kvalifisert personell. Reparasjoner eller utskifting av deler på anlegget av personell som ikke er autorisert, betyr en umiddelbar annullering av produktets garanti. Eventuelle reparasjoner eller utskiftinger av anleggets deler må kun utføres av kvalifisert teknisk personell.



Kutt strømtilførselen til anlegget før ethvert inngrep!

7.1 Utfør følgende periodiske inngrep på generatoren



Bruk trykkluft med lavt trykk og pensler med myk bust for rengjøring innvendig. Kontroller de elektriske koplignene og alle koplignskablene.

7.2 Sorumluluk



Hvis det ordinære vedlikeholdsarbeidet ikke blir utført, blir garantien erklært ugyldig og fabrikanten fritas for alt ansvar. Hvis operatøren ikke følger disse instruksene, frasier fabrikanten seg alt ansvar. Ikke nøl med å ta kontakt med nærmeste tekniske assistansesenter hvis du skulle være i tvil eller det skulle oppstå problemer.

8. ALARM KODER



ALARM

Utløsningen av en alarm eller overstigningen av en kritisk sikkerhetserskel, fører til en visuell varsling på kontrollpanelet og en umiddelbar blokkering av sveisingen.









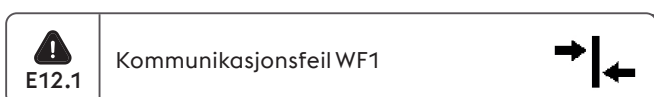
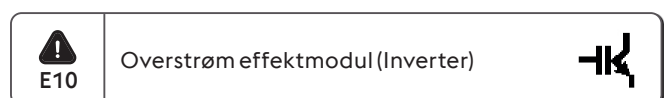
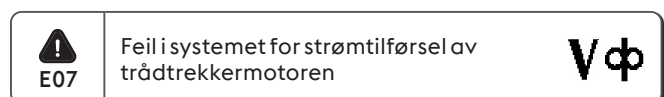















ADVARSEL

Overstigningen av en sikkerhetserskel fører til en visuell varsling på kontrollpanelet, men tillater å fortsette sveisingen.

Nedenfor finnes en liste over anleggets alarmer og sikkerhetsgrenser.



 E14.xx	Ugyldig program feilens underkode angir nummeret til slettet job		 E15	Ugyldig program	
 E16.1	Kommunikasjonsfeil RI 1000/2000/3000 (CAN bus)		 E16.2	Kommunikasjonsfeil RI 3000 (Modbus)	
 E16.3	Kommunikasjonsfeil RI 1000/2000		 E18.xx	Ugyldig program feilens underkode angir nummeret til slettet job	
 E19	Konfigurasjonsfeil av anlegget		 E19.1	Konfigurasjonsfeil av anlegget	
 E19.11	Konfigurasjonsfeil av anlegget (WF)		 E20	Ødelagt minne	
 E21	Datatap		 E23	Sveiseprogrammer finnes ikke	
 E27	Ødelagt minne (RTC)		 E32	Datatap	
 E33.1	Konfigurasjonsfeil av anlegget (LCD 3.5")		 E33.3	Kommunikasjonsfeil (ACTIVATION KEY)	
 E33.4	Kommunikasjonsfeil (ACTIVATION KEY)		 E40	Feil i strømførsel av anlegg	
 E43	Mangel på kjølevæske		 E44	Mangel på gass	
 E48	Mangel på tråd (Automasjon og roboter)		 E50	Fastlimt tråd (Automasjon og roboter)	
 E54	Strømnivå oversteget (Nederste grense)		 E55	Strømnivå oversteget (Øverste grense)	
 E56	Spenningsnivå oversteget (Nederste grense)		 E57	Spenningsnivå oversteget (Øverste grense)	
 E58	Strømningsnivå for gass oversteget (Nederste grense)		 E59	Strømningsnivå for gass oversteget (Øverste grense)	
 E62	Strømnivå oversteget (Nederste grense)		 E63	Strømnivå oversteget (Øverste grense)	
 E64	Spenningsnivå oversteget (Nederste grense)		 E65	Spenningsnivå oversteget (Øverste grense)	
 E66	Strømningsnivå for gass oversteget (Nederste grense)		 E67	Strømningsnivå for gass oversteget (Øverste grense)	

E71	Overtemperatur kjølevæske		E74	Strømnivå motor 1 oversteget	
E76	Strømningsnivå for kjølevæske oversteget		E77	Temperaturnivå kjølevæske	
E80	Mangel på tråd (wire end)		E81	Overstrøm (WU-pumpe)	
E82	Kommunikasjonsfeil (WU)		E83	Pumpe blokkert	
E99.2	Systemkonfigurasjon alarm (inverter)		E99.3	Systemkonfigurasjon alarm (FP)	
E99.4	Systemkonfigurasjon alarm (FP)		E99.5	Systemkonfigurasjon alarm (FP)	
E99.6	Systemkonfigurasjon alarm		E99.11	Ødelagt minne	

9. DIAGNOSTIKK OG LØSNINGER

Blokkert fremtrekk av tråden

Årsak

- » Defekt sveisebrennertast.
- » Feile eller slitte valser.
- » Defekt trådmater.
- » Sveisebrennerens verneutstyr er skadd.
- » Trådtrekkeren er ikke forsynt med strøm.
- » Floke på spolen.
- » Sveisebrennerens dyse er smeltet (tråden er fast).

Løsning

- » Skift ut den skadde komponenten.
- » Henvend deg til det nærmeste senter for teknisk assistanse for å reparere anlegget.
- » Skift ut valsene.
- » Skift ut den skadde komponenten.
- » Henvend deg til det nærmeste senter for teknisk assistanse for å reparere anlegget.
- » Skift ut den skadde komponenten.
- » Henvend deg til det nærmeste senter for teknisk assistanse for å reparere anlegget.
- » Kontroller koplingen til generatoren.
- » Se avsnittet "Kopling".
- » Henvend deg til det nærmeste senter for teknisk assistanse for å reparere anlegget.
- » Løs opp floken på spolen eller skift den ut.
- » Skift ut den skadde komponenten.

Trådens fremtrekk er ikke regelmessig

Årsak

- » Defekt sveisebrennertast.
- » Feile eller slitte valser.
- » Defekt trådmater.
- » Sveisebrennerens verneutstyr er skadd.

Løsning

- » Skift ut den skadde komponenten.
- » Henvend deg til det nærmeste senter for teknisk assistanse for å reparere anlegget.
- » Skift ut valsene.
- » Skift ut den skadde komponenten.
- » Henvend deg til det nærmeste senter for teknisk assistanse for å reparere anlegget.
- » Skift ut den skadde komponenten.
- » Henvend deg til det nærmeste senter for teknisk assistanse for å reparere anlegget.

» Koplingen eller valsenes låseenheter er galt justert.

» Løsne koplingen.
 » Øk trykket på valsene.

Inkludering av slagg

Årsak

» Utilstrekkelig fjerning av slagg.
 » Elektrodens diameter er altfor stor.
 » Gal forberedelse av kantene.
 » Gal modus for utførelse av sveising.

Løsning

» Utfør en nøyaktig rengjøring av stykkene før du utfører sveisingen.
 » Bruk en elektrode med mindre diameter.
 » Øk riflenes åpning.
 » Reduser avstanden mellom elektroden og stykket.
 » La fremgangen skje regelmessig under alle fasene i sveising.

Blåsing

Årsak

» Utilstrekkelig dekkgass.

Løsning

» Reguler korrekt gassflyt.
 » Kontroller at diffusereren og gassmunestykket i sveisebrenneren er i god tilstand.

Klebing

Årsak

» Gal buelengde.
 » Gale sveiseparameterparameter.
 » Gal modus for utførelse av sveising.
 » Stykkene som skal sveises for stor.
 » Gal buedynamikk.

Løsning

» Øk avstanden mellom elektroden og stykket.
 » Øk sveisespenningen.
 » Øk sveisestrømmen.
 » Øk sveisespenningen.
 » Still sveisebrenneren mere i vinkel.
 » Øk sveisestrømmen.
 » Øk sveisespenningen.
 » Øk kretsens induktive verdi.

Sidekutt

Årsak

» Gale sveiseparameterparameter.
 » Gal buelengde.
 » Gal modus for utførelse av sveising.
 » Utilstrekkelig dekkgass.

Løsning

» Reduser sveisestrømmen.
 » Reduser avstanden mellom elektroden og stykket.
 » Reduser sveisespenningen.
 » Senk oscillasjonshastigheten sidestilt ved påfylling.
 » Senk kjørehastigheten under sveising.
 » Bruk gass som er egnet til materialene som skal sveises.

Oksidering

Årsak

» Utilstrekkelig dekkgass.

Løsning

» Reguler korrekt gassflyt.
 » Kontroller at diffusereren og gassmunestykket i sveisebrenneren er i god tilstand.

Porøsitet

Årsak

» Nærvær av fett, malfarge, rust eller skitt på stykkene som skal sveises.
 » Nærvær av fett, malfarge, rust eller skitt på materialene.
 » Der er fukt i støttematerialene.
 » Gal buelengde.

Løsning

» Utfør en nøyaktig rengjøring av stykkene før du utfører sveisingen.
 » Bruk alltid produkter eller materialer av høy kvalitet.
 » Forsikre deg om at materialene alltid er i perfekt brukstilstand.
 » Bruk alltid produkter eller materialer av høy kvalitet.
 » Forsikre deg om at materialene alltid er i perfekt brukstilstand.
 » Reduser avstanden mellom elektroden og stykket.
 » Reduser sveisespenningen.

- » Fuktighet i sveisegassen.
- » Utilstrekkelig dekk-gass.
- » Altfor hurtig overgang til fast form av sveisebadet.
- » Bruk alltid produkter eller materialer av høy kvalitet.
- » Forsikre deg om at gassforsyningsanlegget alltid er i god funksjonstilstand.
- » Reguler korrekt gassflyt.
- » Kontroller at diffusereren og gassmunnstykket i sveisebrenneren er i god tilstand.
- » Senk kjørehastigheten under sveising.
- » Utfør en forvarming av stykkene som skal sveises.
- » Øk sveisestrømmen.

Krakelering på grunn av kulde

Årsak

- » Gale sveiseparameterparameter.
- » Nærvær av fett, malfarge, rust eller skitt på stykkene som skal sveises.
- » Nærvær av fett, malfarge, rust eller skitt på materialene.
- » Gal modus for utførelse av sveising.
- » Stykkene som skal sveises har ulike karakteristikk.

Løsning

- » Reduser sveisestrømmen.
- » Utfør en nøyaktig rengjøring av stykkene før du utfører sveisingen.
- » Bruk alltid produkter eller materialer av høy kvalitet.
- » Forsikre deg om at materialene alltid er i perfekt brukstilstand.
- » Utfør korrekte funksjoner for den type av skjøter som skal sveises.
- » Utfør smøring før du utfører sveiseprosedyren.

Krakelering på grunn av kjølighet

Årsak

- » Der er fukt i støttematerialene.
- » Spesiell geometri i punktet som skal sveises.

Løsning

- » Bruk alltid produkter eller materialer av høy kvalitet.
- » Forsikre deg om at materialene alltid er i perfekt brukstilstand.
- » Utfør en forvarming av stykkene som skal sveises.
- » Utfør en ettervarming.
- » Utfør korrekte funksjoner for den type av skjøter som skal sveises.

10. DRIFTSINSTRUKSJONER

10.1 Kontinuerlig trådsveising (MIG/MAG)

Introduksjon

Et MIG-system består av en likstrømsgenerator, en trådmater og en spole, en brenner og gass.

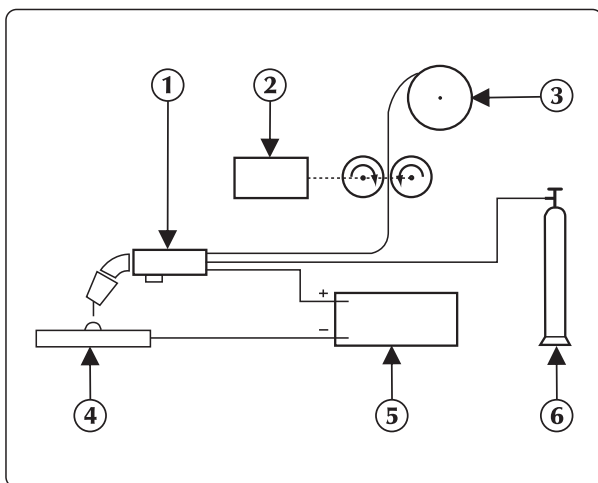

Anlegg for manuell sveising

Strømmen blir overført til buen ved hjelp av sikringsselektroden (tråd tilkoplest positiv pol);

I prosedyren blir det smeltede metallet overført til den del som skal sveises, ved hjelp av buen.

Den automatiske matingen av tråden er nødvendig for å etterfylle tråden som har smeltet under sveisingen.

1. Brenner
2. Trådtrekker
3. Sveisetråd
4. Del som skal sveises
5. Generatoren
6. Gassflaske

Fremgangsmåter

I MIG sveising er det to hovedsaklige metalloverføringsmekanismer tilstede, og de kan klassifiseres i henhold til måten metallet blir overført fra elektroden til arbeidsstykket.

Den første metoden har definisjonen "OVERGANG VED HJELP AV KORTSLUTNING (SHORT-ARC)" som produserer et lite hurtigstorknet sveisebad hvor metallet overføres fra elektroden til arbeidsstykket kun for et kort øyeblikk når elektroden er i kontakt med sveisebadet. I denne tidsrammen kommer elektroden i direkte kontakt med sveisebadet, lager en kortslutning som smelter tråden som derved avbrytes. Buen tennes igjen og syklusen repeteres.

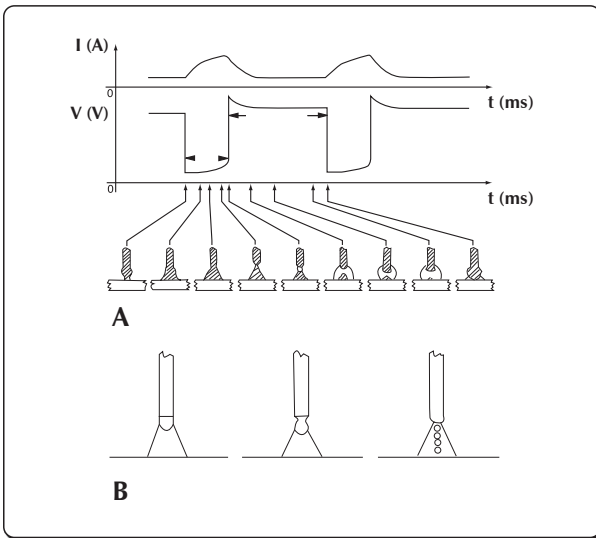

SHORT-syklus og SPRAY ARC sveising

En annen metode for å oppnå overføring av dråpene er "OVERFØRING MED SPRØYT (SPRAY-ARC)", som gjør at det dannes meget små dråper som kan løsne fra tuppen av tråden og overføres til sveisebadet gjennom buestrømmen.

Sveiseparameter

Buens synbarhet minker nødvendigheten for operatøren å kontrollere nøye reguleringstabellene, da han i stedet kan kontrollere fusjonsbadet direkte.

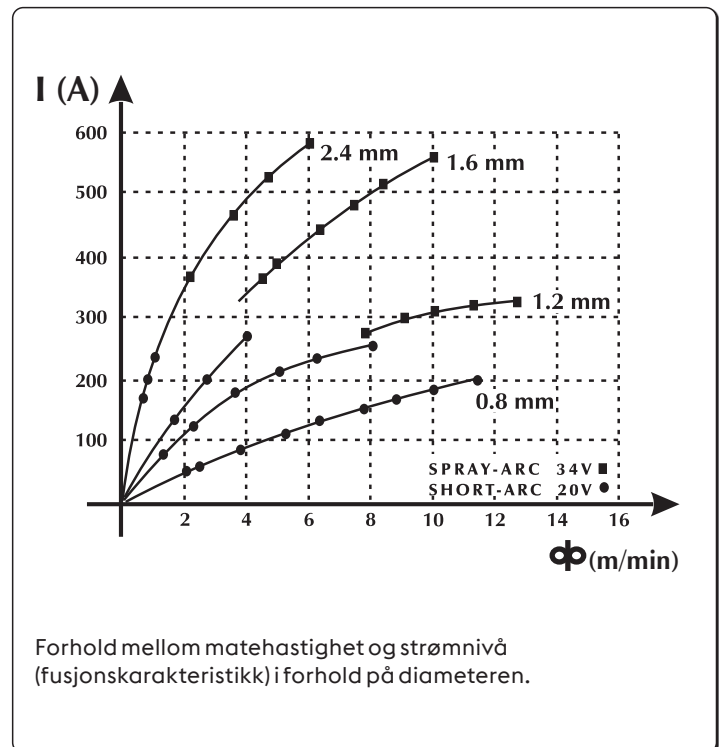
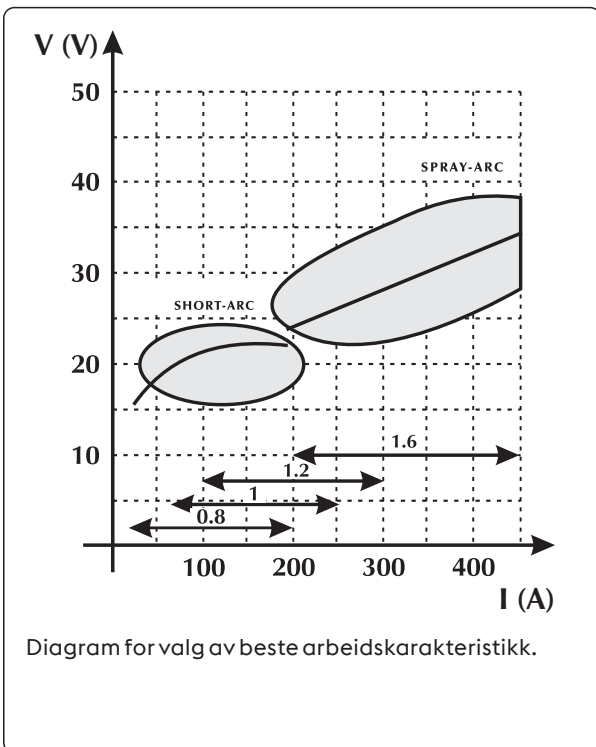

- Spenningen påvirker resultatet direkte, men dimensjonene for sveiseoverflaten kan varieres i forhold til kravene ved at du manuelt dreier sveisebrenneren manuelt, slik at du oppnår varierte deponeringer med konstant spenning.
- Matehastigheten er proporsjonal med sveisestrømmen.

På de to neste figurene vises forholdene mellom de ulike sveiseparameterene.

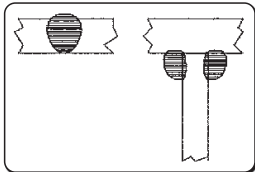
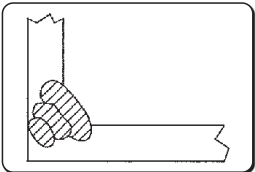
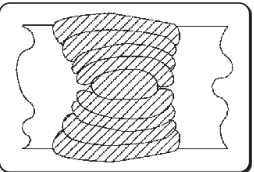

NO

Tabell for valg av sveiseparametrene i forhold til de mest typiske applikasjonene og de mest vanlig brukte typene

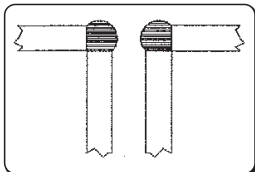
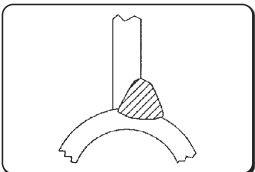
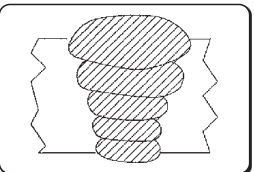
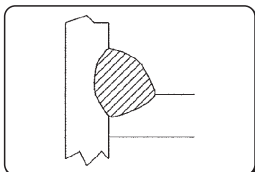
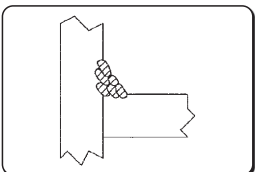
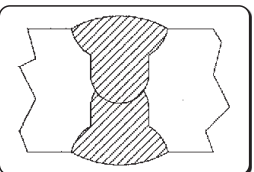
Buespenning	Ø 0,8 mm	Ø 1,0-1,2 mm	Ø 1,6 mm	Ø 2,4 mm
16V - 22V SHORT - ARC				
	60 - 160 A Lav penetrasjon for tynt materiale	100 - 175 A God kontroll av penetrasjon og fusjon	120 - 180 A God flat og vertikal smelting	150 - 200 A Ikke brukt
	<hr/>			
	24V - 28V SEMI SHORT-ARC (Overgangsområde)			
150 - 250 A Automatisk sveising i vinkel		200 - 300 A Automatisk sveising med høy spenning	250 - 350 A Automatisk sveising i skråning	300 - 400 A Ikke brukt
<hr/>				
30V - 45V SPRAY - ARC				
	150 - 250 A Lav penetrasjon med regulering til 200 A	200 - 350 A Automatisk sveising med flere turer	300 - 500 A God penetrasjon i skråning	500 - 750 A Bra penetrasjon, store deponeringer på tykke materialer

Unalloyed steel

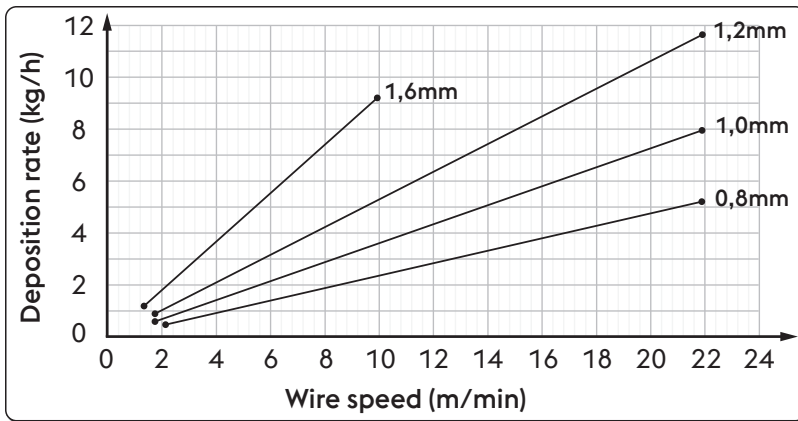

Ø	Wire speed	Deposition rate
0,8 mm	2,0 m/min	0,5 kg/h
	22,0 m/min	5,3 kg/h
1,0 mm	1,6 m/min	0,6 kg/h
	22,0 m/min	8,1 kg/h
1,2 mm	1,6 m/min	0,9 kg/h
	22,0 m/min	11,7 kg/h
1,6 mm	1,2 m/min	1,1 kg/h
	10,0 m/min	9,4 kg/h

High alloyed steel

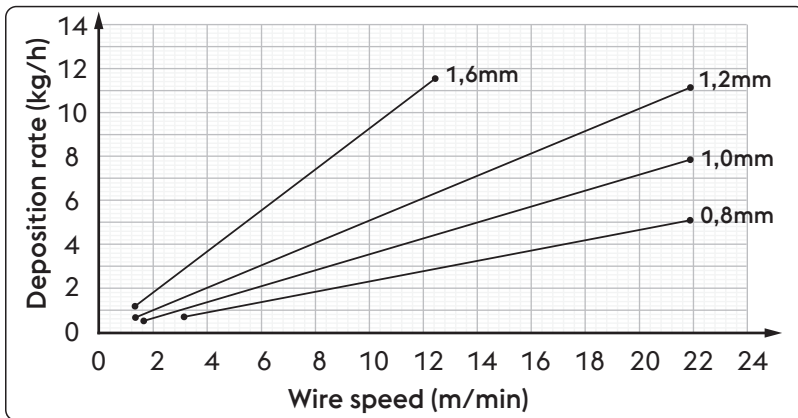

Ø	Wire speed	Deposition rate
0,8 mm	2,0 m/min	0,5 kg/h
	22,0 m/min	5,3 kg/h
1,0 mm	1,6 m/min	0,6 kg/h
	22,0 m/min	8,1 kg/h
1,2 mm	1,6 m/min	0,9 kg/h
	22,0 m/min	11,7 kg/h
1,6 mm	1,2 m/min	1,1 kg/h
	10,0 m/min	9,4 kg/h

Aluminum alloy

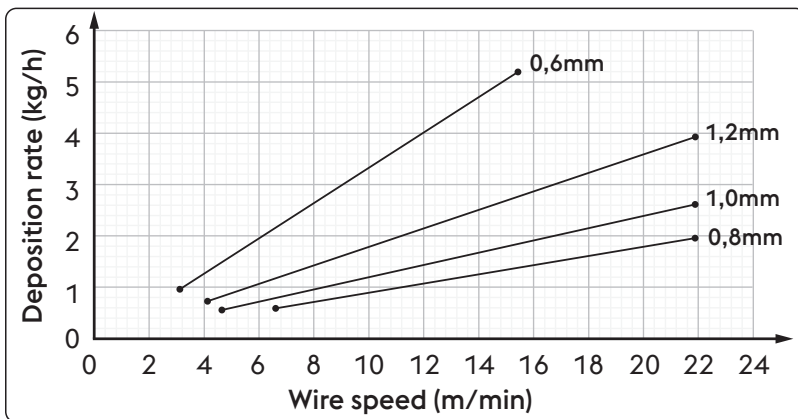

Ø	Wire speed	Deposition rate
0,8 mm	6,5 m/min	0,6 kg/h
	22,0 m/min	2,0 kg/h
1,0 mm	4,5 m/min	0,5 kg/h
	22,0 m/min	2,6 kg/h
1,2 mm	4,0 m/min	0,7 kg/h
	22,0 m/min	4,0 kg/h
1,6 mm	3,0 m/min	0,9 kg/h
	15,5 m/min	5,2 kg/h

Gasser som kan bli brukt

MIG-MAG sveising er karakterisert spesielt av den type av gass som skal brukes for den, inert gass for MIG (Metal Inert Gas) sveising, aktiv gass for MAG (Metal Active Gas) sveising.

- Kulldioksid (CO₂)

Hvis du bruker CO₂ som dekk-gass, kan du oppnå høye penetrasjoner med høy matehastighet og gode mekaniske egenskaper, sammen med lave produksjonskostnader. På den andre siden, bruken av denne gassen skaper store problemer i den endelige kjemiske sammensetningen i fugene, da det skjer et tap av elementer som lett oksideres og samtidig øker kvantiteten av kull i badet.

Sveising med ren CO₂ skaper også andre problemer, som f.eks. altfor mye sprut og danning av porøsiteter pga kulloksyd.

- Argon

Denne inerte gassen blir brukt kun for sveising av lettere legeringer, da det ved sveising av rustfritt stål med krom/nikkel, er å anbefale å bruke argon med tillegg på 2% av oksygen og kulldioksid da dette gir en bedre stabilitet i buen og en bedre forming av sveisen.

- Helium

Denne gassen blir brukt som alternativ til argon og tillater en større penetrasjon (på tykt materiale) og en høyere matehastighet.

- Blanding argon-helium

Du oppnår en stabilere bue enn med ren helium, en større penetrasjon og høyere hastighet enn hvis du bruker argon.

- Blanding argon-kulldioksid og argon-kulldioksid-oksygen

Disse blandinger blir brukt for sveising av ferromaterialer, spesielt i modus som SHORT-ARC, da de termiske karakteristiske trekkene er meget bedre.

Dette utelukker ikke bruken i SPRAY-ARC.

Normalt inneholder blandingen kulldioksid mellom 8% og 20% og oksygen rundt 5%.

Konsultér instruksjonshåndboken for systemet.

Unalloyed steel / High alloyed steel		Aluminum alloy	
Strømområde	Gassflyt	Strømområde	Gassflyt
3-50 A	10-12 l/min	3-50 A	10-12 l/min
30-100 A	10-14 l/min	30-100 A	10-15 l/min
75-150 A	12-16 l/min	75-150 A	12-18 l/min
150-250 A	14-18 l/min	150-250 A	14-22 l/min
250-400 A	16-20 l/min	250-400 A	16-25 l/min
400-500 A	18-22 l/min	400-500 A	18-30 l/min

11. TEKNISK SPESIFIKASJON

Egenskaper til trådtrekkerenheten WF NX 430 SteelDrive		U.M.
Type reduksjonsgir	SL4R-4T	
Trådmater effekt	120	W
Antall valser	4	
Tråddiameter / Standard valse	1.0-1.2	mm
Tråddiameter / Anvendelige valser	Matehastigheten for tråden 0.8-1.6 aluminiumtråd 1.2-2.4 tråd med kjerne	mm/Material
Tast for gasstest	ja	
Matetast for tråd	ja	
Tråd bakover trykk-knapp	no	
Trådhastighet	25 Ø 0.8 - 1.0	m/min
Synergi	ja	
Eksterne enheter	ja (valgfritt)	
Uttak for sveisebrenner Push-Pull	ja (valgfritt)	
Diameter spole	200/300	mm
Diameter fremre hjul	63/125 (optional)	mm
Diameter bakre hjul	63/125 (optional)	mm
Elektriske egenskaper WF NX 430 SteelDrive		U.M.
Strømforsyningsspenning U1	48	Vdc
Kommunikasjonsbuss	DIGITAL	
Maksimal absorbert strøm I1max	4.5	A
Bruksfaktor WF NX 430 SteelDrive		U.M.
Bruksfaktor (40°C)		
(X=50%)	500	A
(X=60%)	470	A
(X=100%)	420	A
Bruksfaktor (25°C)		
(X=80%)	500	A
(X=100%)	470	A
Fysiske egenskaper WF NX 430 SteelDrive		U.M.
Vernegrad IP	IP23S	
Mål (lxdxh)	640x250x460	mm
Vekt	19.0	Kg
Produksjonsnormer	EN IEC 60974-5:2019 EN 60974-10/A1:2015	

12. DATASKILT

VOESTALPINE BÖHLER WELDING SELCO S.R.L. Via Palladio, 19 - ONARA (PADOVA) - ITALY			
WF NX 430		N°	
EN 60974-5:2019 IEC 60974-10/A1:2015 Class A			
	X (40°C)	60%	100%
	I ₂	500A	400A
	U ₁ 48V	I _{1max} 4.5A	
IP 23 S		UK CA CE EAC	
MADE IN ITALY			

13. BESKRIVELSE INFORMASJONSSKILT

1		2	
3		4	
5			
	6	6A	6B
	7	7A	7B
8	9	10	
11		UK CA CE EAC	
MADE IN ITALY			

- 1 Produksjonsmerke
- 2 Navn og adresse til produsenten
- 3 Apparatmodell
- 4 Serienummer
- XXXXXXXXXXXXX Produksjonsår
- 5 Henvisning til konstruksjonsstandarder
- 6 Symbol for periodisk sykklus
- 7 Symbol for nominell sveisestrøm
- 6A Verdier for periodisk sykklus
- 6B Verdier for periodisk sykklus
- 7A Verdier for nominell sveisestrøm
- 7B Verdier for nominell sveisestrøm
- 8 Symbol for strømforsyning
- 9 Nominell forsyningsspenning
- 10 Maksimal nominell strøm
- 11 Beskyttelsesgrad

CE EU-samsvarserklæring
 EAC EAC-samsvarserklæring
 UKCA UKCA-samsvarserklæring

NO

EU-VAATIMUSTENMUKAISUUSVAKUUTUS

Rakentaja

voestalpine Böhler Welding Selco S.r.l. - Via Palladio, 19 - 35019 Onara di Tombolo (PD) - ITALY
Tel. +39 049 9413/111 - Fax +39 049 9413/311 - www.voestalpine.com/welding

vakuuttaa omalla vastuullaan, että seuraava tuote:

WF NX 430 STEELDRIVE 71.01.083

on seuraavien EU-direktiivien mukainen:

2014/35/EU LOW VOLTAGE DIRECTIVE

2014/30/EU EMC DIRECTIVE

2011/65/EU RoHS DIRECTIVE

ja että seuraavia yhdenmukaistettuja standardeja on sovellettu:

EN IEC 60974-5:2019

WIRE FEEDERS

EN 60974-10/A1:2015

ELECTROMAGNETIC COMPATIBILITY REQUIREMENTS

Asiakirjat, jotka todistavat direktiivien noudattamisen, pidetään saatavilla tarkastuksia varten edellä mainitulla valmistajalla.

Jokainen korjaus tai muutos ilman voestalpine Böhler Welding Selco S.r.l.:n antamaa lupaa tekee tästä ilmoituksesta pätemättömän.

Onara di Tombolo, 03/07/2023

voestalpine Böhler Welding Selco s.r.l.

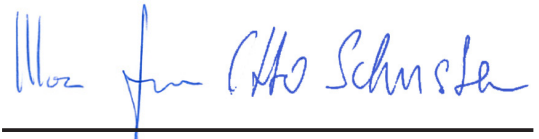

Mirco Frasson

Otto Schuster

Managing Directors

SISÄLLYS

1. VAROITUS.....	385
1.1 Työskentelytila	385
1.2 Käyttäjän ja ulkopuolisten henkilöiden suojaaminen	385
1.3 Suojautuminen höyryiltä ja kaasuilta	386
1.4 Tulipalon tai räjähdysten ehkäisy.....	386
1.5 Kaasupullojen turvallinen käyttö.....	387
1.6 Suojaus sähköiskulta	387
1.7 Sähkömagneettiset kentät ja häiriöt.....	387
1.8 IP-luokitus.....	388
1.9 Loppukäsittely	388
2. ASENNUS	388
2.1 Nosto, kuljetus ja purkaus.....	389
2.2 Laitteen sijoitus.....	389
2.3 Kytkenä.....	389
2.4 Käyttöönotto	389
3. LAITTEEN ESITTELY.....	391
3.1 Takapaneeli.....	391
3.2 Liitäntäpaneeli	391
3.3 Etuohjauspaneeli.....	392
4. LAITTEIDEN KÄYTTÖ	393
4.1 Käynnistysnäyttö.....	393
4.2 Testinäyttö.....	393
4.3 Päänäyttö	393
5. SETUP.....	397
5.1 Set up ja parametrien säätö	397
5.2 Parametrien erityiset käyttötoimenpiteet.....	406
6. LISÄVARUSTEET	409
7. HUOLTO	410
7.1 Suorita seuraavat määräaikaisten tarkastukset virtalähteelle	410
7.2 Räspundere.....	410
8. HÄLYTYSKOODIT	410
9. VIANMÄÄRITYS JA RATKAISUT.....	412
10. KÄYTTÖOHJEET	414
10.1 Hitsauksesta lankaliittämällä (MIG/MAG).....	414
11. TEKNISET OMINAISUUDET	419
12. ARVOKILPI	420
13. KILVEN SISÄLTÖ.....	420
14. KYTKENTÄKAAVIO	459
15. LIITTIMET	460
16. VARAOSALUETTELO	461
17. ASENNUS KIT/LISÄVARUSTEET	464

SYMBOLIT



Välitön vakava hengenvaara tai vaarallinen toiminta, joka voi aiheuttaa vakavan ruumiinvamman.



Tärkeä neuvo, jota noudattamalla vältetään vähäiset vammat tai omaisuusvahingot.



Huomautukset tämän symbolin jälkeen ovat pääosin teknisiä ja helpottavat työskentelyä.

1. VAROITUS



Ennen työskentelyä laitteella, varmista että olet lukenut ja ymmärtänyt tämän käyttöohjeen sisällön.

Älä tee muutoksia tai huoltotoimenpiteitä, joita ei ole kuvattu tässä ohjeessa. Valmistajaa ei voida pitää syyllisenä henkilö- tai omaisuusvahinkoihin, jotka aiheutuvat tämän materiaalin huolimattomasta lukemisesta tai virheellisestä soveltamisesta.

Säilytä käyttöohjeet aina laitteen käyttöpaikassa. Noudata käyttöohjeiden lisäksi voimassa olevia paikallisia tapaturmantorjuntaa ja ympäristön suojelua koskevia yleisiä määräyksiä ja sääntöjä.



Kaikkien laitteen käyttöönottoon, käyttöön, huoltoon ja korjaukseen osallistuvien henkilöiden tulee:

- omata asianmukainen pätevyys
- omata hitsauksessa tarvittavat taidot
- lukea nämä käyttöohjeet kokonaan ja noudattaa niitä tarkasti

Käännä ammattitaitoisen henkilön puoleen epäselvissä tapauksissa sekä koneen käyttöön liittyvissä ongelmissa, myös sellaisissa tapauksissa, joihin näissä ohjeissa ei ole viitattu.

1.1 Työskentelytila



Kaikkia laitteita tulee käyttää ainoastaan siihen käyttöön, mihin ne on tarkoitettu, niiden arvokilvessä ja/tai tässä käyttöoppaassa olevien ohjeiden mukaisesti, noudattaen kansallisia ja kansainvälisiä turvallisuusdirektiivejä. Kaikki muu käyttö katsotaan sopimattomaksi ja vaaralliseksi, eikä valmistaja vastaa virheellisestä käytöstä johtuvista vahingoista.



Tämä laite on suunniteltu vain ammattimaiseen käyttöön teollisessa ympäristössä. Valmistaja ei vastaa vahingoista, jotka ovat aiheutuneet siitä, että laitetta on käytetty kotitaloudessa.



Laitetta tulee käyttää tiloissa, joiden lämpötila on -10°C ja +40°C välillä (+14°F... +104°F).

Laitetta tulee kuljettaa ja varastoida tiloissa, joiden lämpötila on -25°C ja +55°C välillä (-13°F... 131°F).

Laitetta ei saa käyttää tiloissa, joissa on pölyä, happeja, kaasuja tai muita syövyttäviä aineita.

Laitetta ei saa käyttää tiloissa, joiden suhteellinen kosteus on yli 50%, 40°C:ssa (104°F).

Laitetta ei saa käyttää tiloissa, joiden suhteellinen kosteus on yli 90%, 20°C:ssa (68°F).

Laitetta tulee käyttää korkeintaan 2000m (6500 jalkaa) merenpinnan yläpuolella.



Laitteistoa ei saa käyttää putkien sulattamiseen.

Laitetta ei saa käyttää akkujen ja/tai varaajien lataamiseen.

Laitetta ei saa käyttää moottorien käynnistämiseen.

1.2 Käyttäjän ja ulkopuolisten henkilöiden suojaaminen



Hitsausprosessissa muodostuu haitallisia säteily-, melu-, lämpö- ja kaasupurkauksia. Aseta palonkestävä väliseinä suojaamaan hitsausaluetta säteilystä, kipinöistä ja hehkuilta kuona-aineilta. Neuvo muita läheisyydessä olevia henkilöitä välttämään katsomasta hitsausta ja suojautumaan valokaaren säteilystä tai sulametallilta.



Pukeudu suojavaatteisiin suojataksesi ihosi säteilyltä, roiskeilta tai sulalta metallilta. Työvaatteiden tulee peittää koko keho ja niiden tulee olla:

- ehjät ja hyväkuntoiset
- palonkestävät
- eristävät ja kuivat
- kehonmyötäiset, ilman käänteitä



Käytä aina standardin mukaisia, kestäviä ja vedenpitäviä jalkineita.

Käytä aina standardin mukaisia, kuumalta ja sähkön aiheuttamilta vaaroilta suojaavia käsineitä.



Käytä silmien suojana hitsausmaskia tai muuta sopivaa suojaa (vähintään NR10 tai enemmän).



Käytä aina sivusuojilla varustettuja suojalaseja, varsinkin poistettaessa hitsauskuonaa mekaanisesti tai käsin.



Älä käytä piilolinssijä!



Käytä kuulonsuojaimia jos hitsaustapahtuma aiheuttaa melun kohoamisen haitalliselle tasolle. Jos melutaso ylittää lain asettaman ylärajan, eristä työskentelyalue ja varmista että alueelle tulevat henkilöt käyttävät kuulonsuojaimia.



Sivupaneelit on pidettävä aina suljettuina hitsaustoimenpiteiden aikana. Laitteeseen ei saa tehdä minkäänlaisia muutoksia. Estä käsien, hiusten, vaatteiden ja työvälineiden kosketus liikkuviin osiin, kuten: puhaltimet, hammaspyörät, rullat ja akselit, lankakelat. Älä käytä hammaspyörää langansyöttölaitteen allessa toiminnassa. Langansyöttöyksikön suojalaitteiden poistaminen on erittäin vaarallista eikä valmistaja vastaa tästä aiheutuvista henkilö- tai esinevahingoista.



Pidä kasvot loitolla mig/mag polttimesta langan syötön ja ohjauksen ajan. Ulostuleva lanka voi aiheuttaa vakavia vammoja käsiin, kasvoihin ja silmiin.



Älä koske juuri hitsattuja kappaleita, kuumuus voi aiheuttaa vakavia palovammoja tai -haavoja. Noudata edelläkuvattuja varotoimenpiteitä myös hitsauksen jälkeisissä toimenpiteissä, sillä jäähtyvistä työkappaleista saattaa irrota kuonaa.



Tarkista, että poltin on jäähtynyt ennen huolto- tai työskentelytoimenpiteiden aloittamista.



Tarkista, että jäähdytysyksikkö on sammutettu ennen kuin irrotat jäähdytysnesteen syöttö- ja takaisinvirtausletkut. Ulostuleva kuuma neste voi aiheuttaa vakavia palovammoja tai -haavoja.



Pidä ensiapupakkaus aina lähetyvillä. Älä aliarvioi palovammojen tai muiden loukkaantumisten mahdollisuutta.



Ennen kuin poistut työpaikalta, varmista työskentelyalueen turvallisuus henkilö- ja esinevahinkojen välttämiseksi.

1.3 Suojautuminen höyryiltä ja kaasuilta



Hitsauksen muodostamat savut, kaasut ja pölyt voivat olla terveydelle haitallisia. Hitsauksen aikana muodostuneet höyryt saattavat määrityissä olosuhteissa aiheuttaa syöpää tai vahingoittaa sikiötä raskauden aikana.

- Pidä kasvot loitolla hitsauksessa muodostuneista kaasuista ja höyryistä.
- Järjestä kunnollinen ilmanvaihto, joko luonnollinen tai koneellinen, työskentelytilaan.
- Jos ilmanvaihto ei ole riittävä, on käytettävä kaasunsuodattimin varustettuja hengityksensuojaimia.
- Ahtaissa tiloissa hitsattaessa tulisi työtoverin valvoa hitsaustyötä ulkopuolelta.
- Älä käytä happea ilmanvaihtoon.
- Varmista ilmanvaihdon tehokkuus tarkistamalla säännöllisesti, ettei myrkyllisten kaasujen määrä ylitä turvallisuussäännöksissä esitettyä rajaa.
- Muodostuneiden höyryjen määrä ja vaarallisuus voidaan määrittellä käytettävän perusmateriaalin, lisäaineen, sekä hitsattavien kappaleiden puhdistukseen ja rasvanpoistoon mahdollisesti käytettyjen aineiden perusteella.
- Älä hitsaa tiloissa, joissa käytetään rasvanpoisto- tai maaliaineita.
- Sijoita kaasupullot avoimiin tiloihin tai paikkaan, jossa on hyvä ilmankierto.

1.4 Tulipalon tai räjähdysten ehkäisy



Hitsausprosessi saattaa aiheuttaa tulipalon ja/tai räjähdysten.

- Tyhjennä työalue ja ympäristö kaikesta tulenarasta tai palo-herkästä materiaalista ja esineistä.
- Helposti syttyvien materiaalien tulee olla vähintään 11 metrin (35 jalkaa) etäisyydellä hitsaustilasta, tai asianmukaisesti suojattuina.
- Kipinät ja hehkuvat hiukkaset voivat helposti sinkoutua ympäristöön myös pienistä aukoista. Varmista tarkoin henkilöiden ja esineiden turvallisuus.
- Älä hitsaa paineistettujen säiliöiden päällä tai läheisyydessä.
- Älä tee hitsaustöitä säiliössä tai putkessa. Ole erittäin tarkkana hitsatessasi putkia ja säiliöitä, myös silloin, kun ne ovat avoimia, tyhjennettyjä ja hyvin puhdistettuja. Kaasun, polttoaineen, öljyn tai muiden vastaavien aineiden jäännökset voivat aiheuttaa räjähdyksiä.
- Älä hitsaa tilassa, jonka ilmapiirissä on pölyä, kaasuja tai räjähdysalttiita höyryjä.
- Tarkista hitsaustapahtuman päätteeksi, ettei jännitteinen piiri pääse vahingossa koskettamaan maadoituspiiriin kytkettyjä osia.
- Sijoita tulensammutusmateriaali lähelle työaluetta.

1.5 Kaasupullojen turvallinen käyttö



Suojakaasupullot sisältävät paineenalaista kaasua ja voivat räjähtää huonoissa kuljetus-, säilytys- ja käyttöolosuhteissa.

- Kaasupullot tulee kiinnittää pystyasentoon seinälle tai muuhun telineeseen, jotta ne olisivat suojattuina kaatumiselta ja mekaanisilta iskuilta.
- Suojakuvun on aina oltava suljettuna kun pulloa siirretään, kun se otetaan käyttöön ja kun hitsaustoimenpiteet ovat päättyneet.
- Suojaa kaasupullot suoralta auringonsäteilyltä, äkillisiltä lämpötilanmuutoksilta, sekä erittäin korkeilta tai alhaisilta lämpötiloilta. Älä sijoita kaasupulloja erittäin korkeisiin tai alhaisiin lämpötiloihin.
- Kaasupullot eivät saa joutua kosketuksiin liekkien, sähkökaarien, polttimien tai elektrodinpitimien, eikä hitsauksen muodostamien hehkuvien säteiden kanssa.
- Pidä kaasupullot etäällä hitsauspiiristä sekä kaikista muista virtapiireistä.
- Pidä kasvosäiliö etäällä kaasun ulostulopisteestä kaasupullon venttiiliä avattaessa.
- Sulje venttiili aina työskentelyn päättyttyä.
- Älä koskaan hitsaa paineenalaisen kaasun säiliötä.
- Älä ikinä kytke paineilmapulloa suoraan laitteen paineenalennusventtiiliin! Paine saattaa ylittää paineenalennusventtiilin kapasiteetin ja aiheuttaa räjähdysriskin!

1.6 Suojaus sähköiskulta



Sähköisku voi johtaa kuolemaan.

- Älä koske hitsauslaitteen sisä- tai ulkopuolella olevia jännitteisiä osia laitteen ollessa virtalähteeseen kytkettynä (polttimet, pihdit, maadoituskaapelit, elektrodit, rullat ja kelat on kytketty sähköisesti hitsauspiiriin).
- Varmista järjestelmän ja käyttäjän sähköeristys käyttämällä kuivia tasoja ja alustoja, jotka on eristetty riittävästi maa- ja laitteen potentiaalilta.
- Varmista, että laite liitetään oikein pistokkeeseen sekä verkkoon, joka on varustettu suojavaajohtimella.
- Älä koske kahta poltinta tai hitsauspuikonpidintä samanaikaisesti.
- Jos tunnet sähköiskun, keskeytä hitsaustoimenpiteet välittömästi.

1.7 Sähkömagneettiset kentät ja häiriöt



Laitteen sisäisten ja ulkoisten kaapelien läpi kulkeva virta muodostaa sähkömagneettisen kentän hitsauskaapelien sekä itse laitteen läheisyyteen.

- Sähkömagneettiset kentät saattavat vaikuttaa sellaisten henkilöiden terveydentilaan, jotka altistuvat niille pitkäaikaisesti (vaikutusten laatua ei vielä tunneta).
- Sähkömagneettiset kentät saattavat aiheuttaa toimintahäiriöitä muihin laitteisiin, esimerkiksi sydämentahdistimeen tai kuulolaitteeseen.



Henkilöiden, joilla on sydämentahdistin, täytyy ensin keskustella lääkärin kanssa, ennen kuin voivat mennä hitsauslaitteen läheisyyteen kaarihitsauksen.

1.7.1 EMC-luokitus standardin mukaisesti: EN 60974-10/A1:2015.



Luokan B laite täyttää sähkömagneettisen yhteensopivuuden vaatimukset teollisuus- ja asuin ympäristössä, mukaan lukien asuintalot, joissa sähköjakelu tapahtuu julkisen matalajänniteverkon kautta.



Luokan C laitetta ei ole tarkoitettu käytettäväksi asuintaloissa, joissa sähköjakelu tapahtuu julkisen matalajänniteverkon kautta. Luokan A laitteiden sähkömagneettisen yhteensopivuuden saavuttaminen voi olla vaikeaa näissä olosuhteissa johtuvien ja säteilevien häiriöiden takia.

Katso lisätietoja luvusta: ARVOKILPI tai TEKNISET OMINAISUUDET.

1.7.2 Asennus, käyttö ja alueen tarkistus

Tämä laite on valmistettu yhdenmukaistettua standardia noudattaen EN 60974-10/A1:2015 ja on luokiteltu "A LUOKKAAN". Tämä laite on suunniteltu vain ammattimaiseen käyttöön teollisessa ympäristössä. Valmistaja ei vastaa vahingoista, jotka ovat aiheutuneet siitä, että laitetta on käytetty kotitaloudessa.



Laitteen käyttäjän tulee olla alan ammattilainen, joka on vastuussa laitteen asennuksesta ja sen käytöstä valmistajan ohjeita noudattaen. Jos jotain sähkömagneettista häiriötä on havaittavissa niin käyttäjän on ratkaistava ongelma, jos tarpeen yhdessä valmistajan teknisellä avulla.



Kaikkissa tapauksissa sähkömagneettisia häiriöitä on vaimennettava niin paljon, etteivät ne enää aiheuta haittaa.



Ennen laitteen asennusta käyttäjän on arvioitava sähkömagneettiset ongelmat, jotka mahdollisesti voivat tulla esiin lähiympäristössä, keskittyen erityisesti henkilöiden terveydentilaan, esimerkiksi henkilöiden, joilla on sydäntahdistin tai kuulokoje.

1.7.3 Kaapeleita koskevat varotoimet

Sähkömagneettisten kenttien vaikutuksen vähentämiseksi:

- Kelaa maadoituskaapeli ja voimakaapeli yhdessä ja kiinnitä mahdollisuuksien mukaan.
- Älä kelaa kaapeleita kehosi ympärille.
- Älä mene maadoituskaapelin ja voimakaapelin väliin (pidä molemmat samalla puolella).
- Kaapelit on pidettävä mahdollisimman lyhyinä ja lähellä toisiaan, ja niiden tulee olla maassa tai lähellä maatasoa.
- Aseta laite määrätyn välimatkan päähän hitsausalueesta.
- Kaapelit tulee sijoittaa etäälle muista mahdollisista kaapeleista.

1.7.4 Maadoitus

Hitsauslaitteiston ja sen läheisyydessä olevien metalliosien maakytkentä on varmistettava. Suojamaadoituskytkentä on tehtävä kansallisten määräysten mukaisesti.

1.7.5 Työstettävän kappaleen maadoittaminen

Mikäli työstettävää kappaletta ei ole maadoitettu sähköisten turvatoimien tai kappaleen koon tai sijainnin vuoksi, työstettävän kappaleen maadoitus saattaa vähentää sähkömagneettisia päästöjä. On tärkeää ymmärtää, että maadoitus ei saa lisätä onnettomuusriskiä eikä vahingoittaa sähköisiä laitteita. Maadoitus on tehtävä kansallisten määräysten mukaisesti.

1.7.6 Suojaus

Ympäristön muiden kaapeleiden ja laitteistojen valikoiva suojaus voi vähentää häiriöongelmia. Koko hitsauslaitteiston suojaus voidaan ottaa huomioon erikoissovellutuksissa.

1.8 IP-luokitus



IP23S

- Kotelo on suojattu läpimitoiltaan 12,5 mm tai suurempien kiintoaineiden läpituonkeutumiselta, ja vaaralliset osat on kosketussuojattu sormilta.
- Kotelointi suojaa roiskevedeltä joka suuntautuu 60° kulmassa pystysuunnasta.
- Kotelointi suojaa sellaisia vaurioita vastaan, jotka aiheuttaa veden sisäänkäyminen laitteiston liikkuvien osien ollessa liikkeessä.

1.9 Loppukäsittely



Älä hävitä sähkölaitetta tavallisten jätteiden seassa!

Sähkö- ja elektroniikkalaiteromua koskevan eurooppalaisen direktiivin 2012/19/EU ja sen täytäntöönpaneuvien kansallisten lakien mukaisesti sähkölaitteet tulee käyttökänsä päätyttyä erilliskerätä ja toimittaa kierrätys- ja loppukäsittelykeskukseen. Laitteen omistajan tulee tiedustella valtuutetuista jätteenkeräyskeskuksista paikallisviranomaisilta. Eurooppalaisen direktiivin soveltaminen vaikuttaa myönteisesti ympäristöön ja ihmisten terveyteen.

» Etsi lisätietoja sivustolta.

2. ASENNUS



Ainoastaan valmistajan valtuuttama henkilöstö saa suorittaa asennuksen.



Varmista asennuksen aikana, että generaattori on irti syöttöverkosta.

2.1 Nosto, kuljetus ja purkaus

- Laitteessa on kahva, jonka avulla sitä voidaan kuljettaa kädessä.
- Laitteessa ei ole erityisiä nosto-osia.
- Käytä haarukkanostinta, noudattaen äärimmäistä varovaisuutta, jotta generaattori ei pääse kallistumaan.



Älä koskaan aliarvioi laitteen painoa, katso kohta Tekniset ominaisuudet.

Älä koskaan kuljeta laitetta tai jätä sitä roikkumaan niin, että sen alla on ihmisiä tai esineitä.

Älä anna laitteen kaatua äläkä pudota voimalla.

2.2 Laitteen sijoitus



Noudata seuraavia sääntöjä:

- Varmista helppo pääsy laitteen säätöihin ja liitäntöihin.
- Älä sijoita laitetta ahtaaseen paikkaan.
- Älä aseta laitetta vaakasuoralle tasolle tai tasolle, jonka kaltevuus on yli 10°.
- Kytke laitteisto kuivaan ja puhtaaseen tilaan, jossa on sopiva ilmastointi.
- Suojaa kone sateelta ja auringolta.

2.3 KytKentä





Liikkuvat yksiköt toimivat yksinomaan matalalla jännitteellä.

2.4 Käyttöönotto

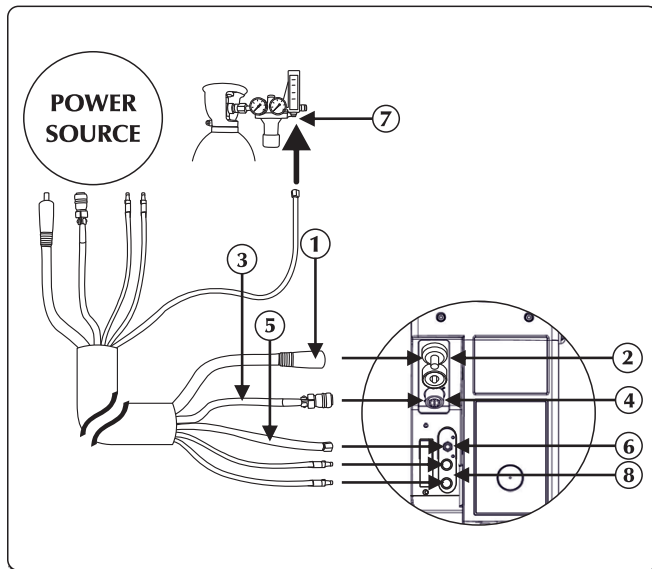
2.4.1 Liitäntä MIG/MAG hitsausta varten



- ① Virtajohto
- ② Positiivinen liitäntä (+)
- ③ Signaalikaapeli
- ④ Merkinantokaapelin syöttö
- ⑤ Kaasuputki
- ⑥ Kaasuliitin
- ⑦ Kaasun syöttöliitin
- ⑧ Jäähdytysnesteen liitäntä

- ▶ Liitä johdinsarjan voimakaapeli pistorasiaan. Kytke pistoke ja kierrä myötäpäivään, kunnes osat ovat kokonaan kiinni.
- ▶ Liitä johdinsarjan merkinantokaapeli liittimeen. Työnnä liitin paikoilleen ja kierrä rengasmutteria myötäpäivään, kunnes liitos on tiukalla.
- ▶ Kiinnitä johdinsarjan kaasuletku kaasupullon paineenalennusventtiiliin tai kaasun syöttöliitokseen. Säätelä kaasuvirtausta nostamalla se määrästä 10 l/min määrään 30 l/min.
- ▶ Kiinnitä johdinsarjan jäähdytysaineen syöttöletku (sininen) liitäntään/kytkentään (sininen - symboli .
- ▶ Kiinnitä johdinsarjan jäähdytysaineen takaisinvirtausletku (punainen) liitäntään/kytkentään (punainen - symboli .
- ▶ Kytke CAN-BUS-signaaliikaapeli ulkoisten laitteiden ohjausta varten (kuten RC, RI...) asianmukaiseen liittimeen.

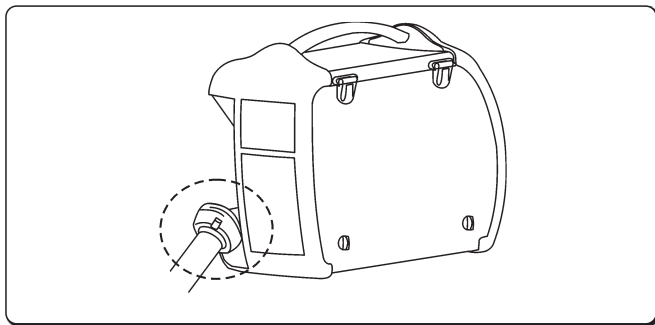

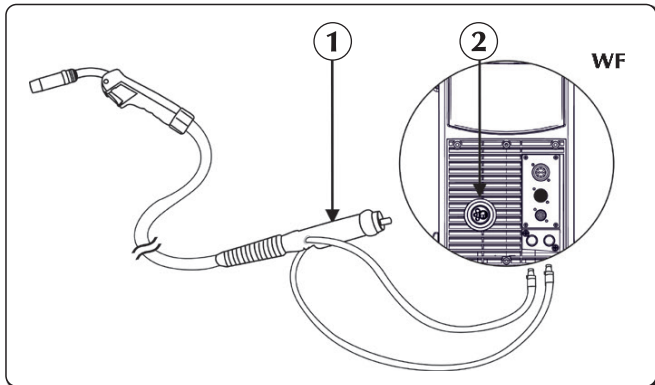

Katso kappale "Asennus lisävarusteet".



① Polttimen liitäntä

② Liittim

- ▶ Kiinnitä polttimen jäähdytysaineen takaisinvirtausletku (punainen) liitäntään/kytkentään (punainen - symboli ).
- ▶ Kiinnitä polttimen jäähdytysaineen syöttöletku (sininen) liitäntään/kytkentään (sininen - symboli .
- ▶ Kytke MIG/MAG-poltin liittimeen, huolehtien kiinnitysrenkaan kiertämisestä tiukasti kiinni;

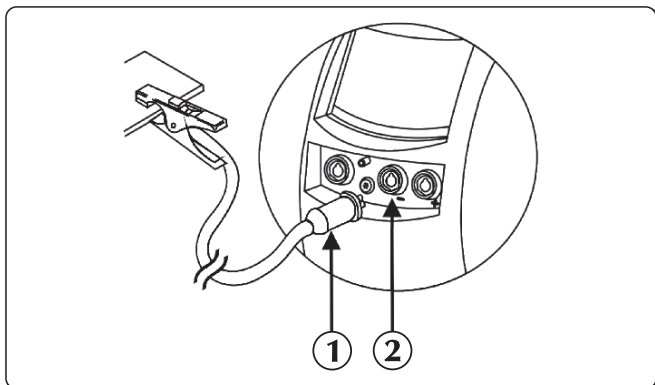

① Maadoitusliitin

② Negatiivinen liitäntä (-)

- ▶ Kiinnitä maadoituskiinnikkeen liitin virtalähteen miinusnapaan (-). Kytke pistoke ja kierrä myötäpäivään, kunnes osat ovat kokonaan kiinni.

Moottoritila

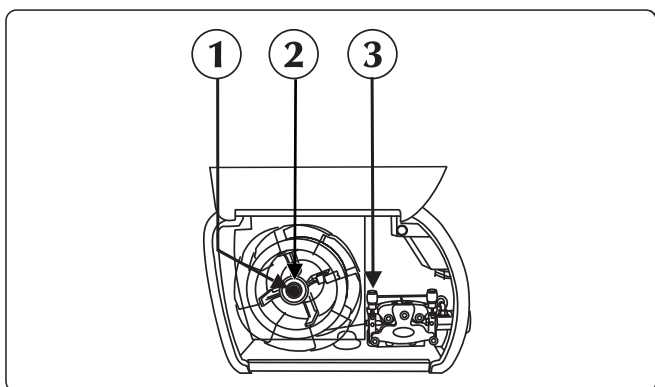

① Rengasmutteri

② Kitkaruuvi

③ Hammaspyörämoottorin vetolaitteen tuki

- ▶ Avaa oikealla sivulla oleva suojakuori.
- ▶ Tarkista, että rullan uurre on sama kuin haluamasi langan halkaisija.
- ▶ Avaa letkukelalaitteen puolan ruuvi ja aseta puola.
- ▶ Aseta myös kelan tappi oikein, työnnä kela paikalleen, laita rengasmutteri takaisin ja säädä kitkaruuvi.

- ▶ Irrota hammaspyörämootorin vetolaitteen tuki ujuttamalla langan pään kuidunohjaimen ohjausholkkiin ohjaten sen rullaan, polttimen liittimeen. Pysäytä vetolaitteen tuki tarkastaen, että lanka on mennyt rullien uurteiden sisälle.
- ▶ Paina langansyötön painiketta langan asentamiseksi polttimeen.
- ▶ Säädtele kaasuvirtausta nostamalla se määrästä 10 l/min määrään 30 l/min.

3. LAITTEEN ESITTELY

3.1 Takapaneeli

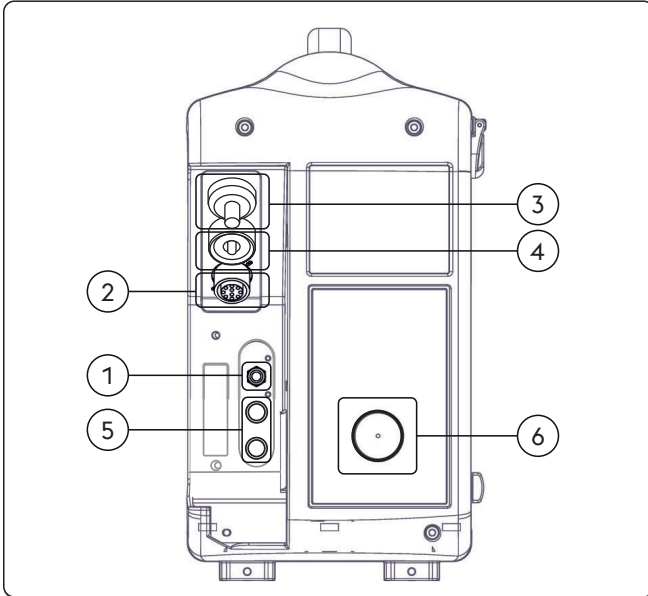

- ① Kaasuliitäntä
- ② Signaalikaapelin tulo (CAN-BUS) (kaapelinippu)
- ③ Virtakaapelin tulo (kaapelinippu)
- ④ Positiivinen liitäntä (+)
- ⑤ Jäähdytysnesteen tulo/lähtö
- ⑥ Langan tulo



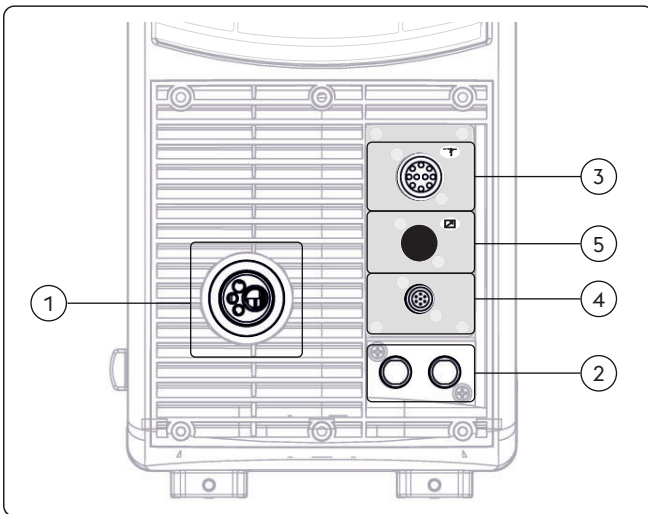



3.2 Liitäntäpaneeli

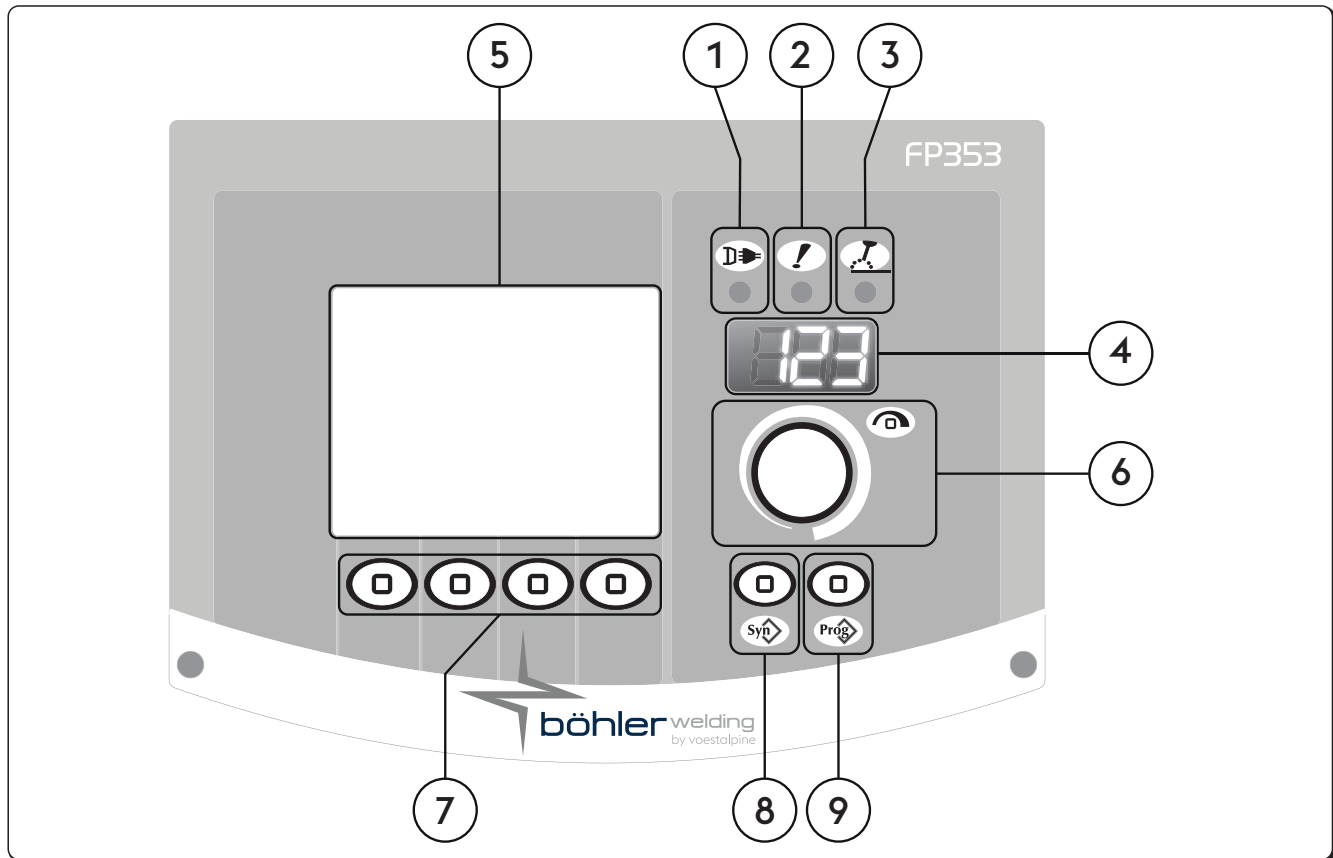

- ① Polttimen liitäntä
Sen avulla suoritetaan MIG/MAG-polttimen liitäntä.
- ② Jäähdytysnesteen liitäntä
- ③ Merkinantokaapelin syöttö (Push-Pull)
- ④ Signaalikaapelin tulo (poltin)
Polttimen liitäntä
- ⑤ Signaalikaapelin (RC) tuloliitäntä

3.3 Etuohjauspaneeli



- 1  **Virran merkkivalo**
Ilmaisee, että laite on kytketty verkkojännitteeseen ja jännite on päällä.
- 2  **Yleishälytyksen merkkivalo**
Ilmaisee mahdollisen suojalaitteiden laukeamisen, esimerkkinä lämpösuoja.
- 3  **Aktiivisen tehon merkkivalo**
Ilmaisee jännitteen olemassaolon laitteen lähtöliitännöissä.
- 4  **7-segmenttinäyttö**
Mahdollistaa hitsauskoneen parametrien näytön käynnistyksen aikana, asetusten, virta- ja jännitelukemien näytön hitsauksen aikana sekä hälytysten ilmaisen.
- 5  **LCD-näyttö**
Mahdollistaa hitsauskoneen parametrien näytön käynnistyksen aikana, asetusten, virta- ja jännitelukemien näytön hitsauksen aikana sekä hälytysten ilmaisen.
Mahdollistaa toimintojen välittömän näytön.
- 6  **Pääsätövipu**
Mahdollistaa pääsyn asetustilaan hitsausparametrien valintaa ja asettamista varten.
- 7  **Toimintonäppäimet**
Mahdollistaa eri järjestelmätoimintojen valinnan:
- Hitsausprosessi
- Hitsausmenetelmät
- Virran pulssitus
- Graafinen tila

8  **Hitsausohjelman näppäin**

Mahdollistaa esiasetetun hitsausohjelman valinnan valitsemalla muutamia yksinkertaisia asetuksia:

- Langan tyyppi
- Kaasun tyyppi
- Langan halkaisija

9  **Työohjelman näppäin**

4. LAITTEIDEN KÄYTTÖ

4.1 Käynnistysnäyttö

Kun virta kytketään, generaattori suorittaa itsetestausjakson järjestelmän ja kytkettyjen laitteiden oikean toiminnan varmistamiseksi. Tässä vaiheessa suoritetaan myös kaasutesti kaasunsyötön oikean toiminnan tarkastamiseksi.

4.2 Testinäyttö

Hitsaustoiminnot on estetty, kun sivupaneeli (kelaosasto) on auki.

LCD-näytölle tulee testinäyttö.

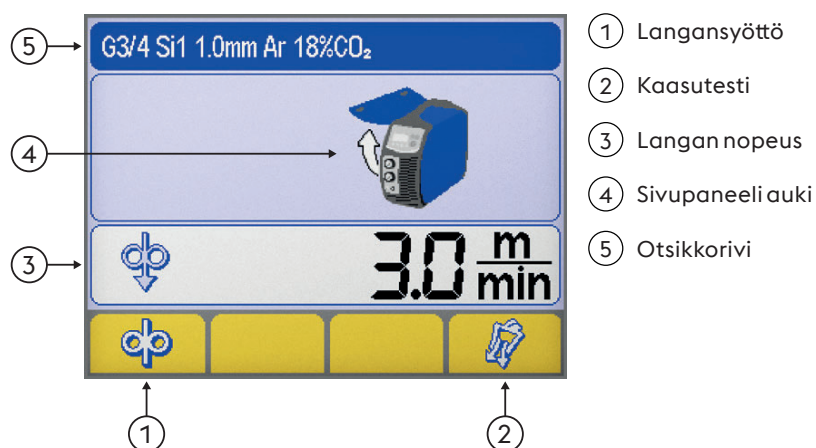
Langansyöttö

Mahdollistaa langan käsityön ilman kaasua ja virtaa langassa.
Mahdollistaa langan asettamisen poltinrunkoon hitsauksen valmisteluvaiheissa.

Kaasutesti

Mahdollistaa kaasupiirin tyhjentämisen epäpuhtauksista sekä kaasun paineen ja virtauksen esisäädön hitsaustehoa kytkemättä.

Langan nopeus

Mahdollistaa langan syöttönopeuden säädön (kuormauksen aikana vaiheen).

Minimi	Maksimi	Oletus
0.5 m/min	22.0 m/min	3.0 m/min

Sivupaneeli auki

Otsikkorivi

Mahdollistaa tiettyjen tärkeiden tietojen näytön valitusta prosessista.

4.3 Päänäyttö

Mahdollistaa järjestelmän ja hitsausprosessin säädön, ja näyttää tärkeimmät asetukset.

4.4 MIG/MAG -prosessin päänäyttö

Perusnäyttö

① Otsikkorivi MIG/MAG-prosessi
 ② Hitsausparametrit
 ③ Toiminnot

Graafinen näyttö

① Otsikkorivi MIG/MAG-prosessi
 ② Hitsausparametrit
 ③ Toiminnot

Otsikkorivi MIG/MAG-prosessi

Mahdollistaa tiettyjen tärkeiden tietojen näytön valitusta prosessista.

Valittu synergiäkäyrä
 ① Täyteaineen tyyppi
 ② Langan halkaisija
 ③ Kaasun tyyppi

Hitsausparametrit
 ① Hitsausvirta
 ② Kappaleen paksuus
 ③ Kulmapalko "a"
 ④ Hitsausjännite

Hitsausparametrit (Perusnäyttö)

► Valitse haluttu parametri painamalla säätönapin painiketta.

① Hitsausparametrit
 ② Parametrin kuvake
 ③ Parametrin arvo
 ④ Parametrin mittayksikkö

Hitsausparametrit (Graafinen näyttö)

► Valitse haluttu parametri painamalla säätönupin painiketta.

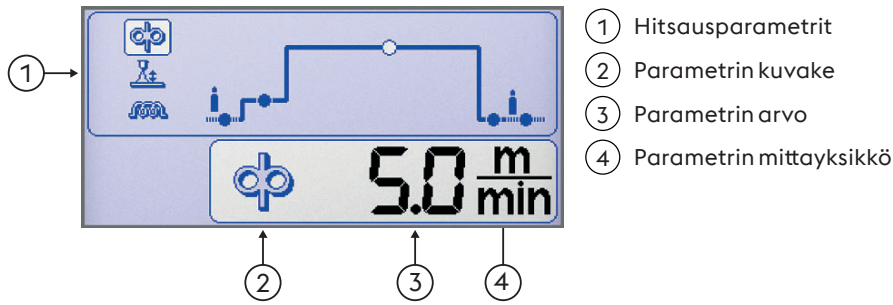

Toiminnot

Mahdollistaa prosessin tärkeimpien toimintojen ja hitsausmenetelmien asettamisen.

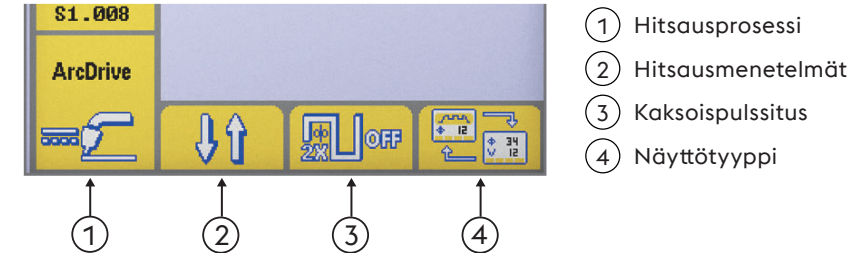

Hitsausmenetelmät

Mahdollistaa hitsausmenetelmän valinnan

- 

2 vaihetta
Kahdessa vaiheessa painikkeen painaminen käynnistää kaasuvirtauksen, kytkee jännitteen lankaan ja käynnistää langansyötön; vapautettaessa painike kaasu, jännite ja langansyöttö katkeavat.
- 

4 vaihetta
Neljässä vaiheessa painikkeen ensimmäinen painallus käynnistää kaasuvirtauksen, jolloin annetaan manuaalinen esikaasu; painikkeen vapauttaminen kytkee jännitteen lankaan ja käynnistää langansyötön. Seuraava painallus pysäyttää langansyötön ja käynnistää lopetusprosessin, jolloin virta palautuu noltaan; painikkeen vapauttaminen katkaisee lopuksi kaasuvirtauksen.
- 

Crater filler
Mahdollistaa hitsaamisen kolmella eri tehotasolla, jotka hitsaaja voi valita ja säätää suoraan polttimen painikkeesta.
Painikkeen ensimmäinen painallus käynnistää kaasuvirtauksen, kytkee jännitteen lankaan ja syöttää lankaa "alkunopeus"-parametrilla (alkuasetuksissa) ja suhteellisilla synergiaparametreilla asetetulla nopeudella.
Kun polttimen painike vapautetaan, langan nopeus ja suhteelliset synergiaparametrit vaihtuvat automaattisesti ohjauspaneelista asetettuihin pääarvoihin.
Seuraava polttimen painikkeen painallus asettaa langan nopeuden ja suhteelliset synergiaparametrit esiasetettuihin (alkuasetuksissa) kraatterintäytön parametriarvoihin.
Polttimen painikkeen vapauttaminen pysäyttää langansyötön ja antaa virtaa takaisinpoltto- ja jälkikaasuvaiheisiin.

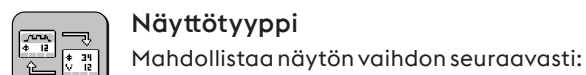
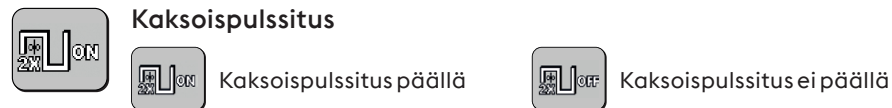

Synergiäkäyrien näyttö



Synergia

Mahdollistaa esiasetetun hitsausohjelman valinnan (synergia) valitsemalla muutamia yksinkertaisia asetuksia

Hitsausprosessin valinta

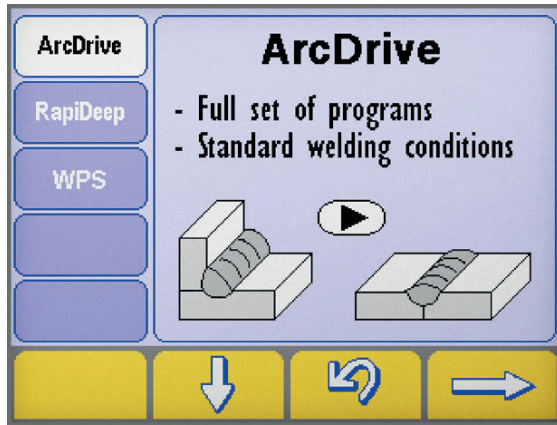

- ▶ Avaa Synergiat-näyttö painamalla näppäintä vähintään sekunnin ajan.
- ▶ Valitse haluttu prosessi painamalla näppäimiä e .
- ▶ Paina painiketta siirtyäksesi seuraavaan vaiheeseen.



Materiaalityypin/kaasutyyppin synergian valintanäyttö

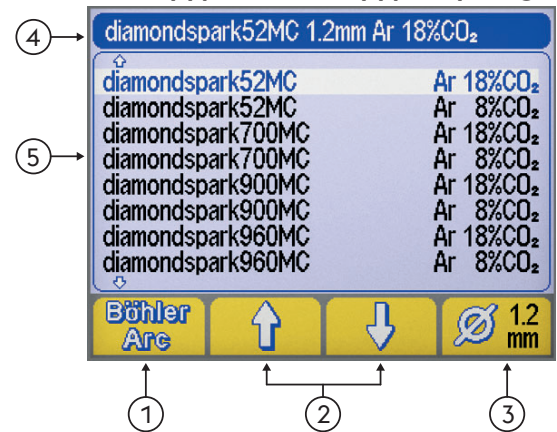

- 1 Hitsausohjelman (BöhlerArc/UniversalArc)
- 2 Materiaalin/kaasun valinta
- 3 Langan halkaisija
- 4 Otsikkorivi
- 5 Hitsausohjelman

Böhler Arc Hitsausohjelman
Mahdollistaa hitsausohjelman valinnan

BöhlerArc UniversalArc

Materiaalin/kaasun valinta
Mahdollistaa valinnan:

- Täyteaineen tyyppi
- Kaasun tyyppi

Langan halkaisija
Mahdollistaa käytettävän langan halkaisijan (mm) valinnan.

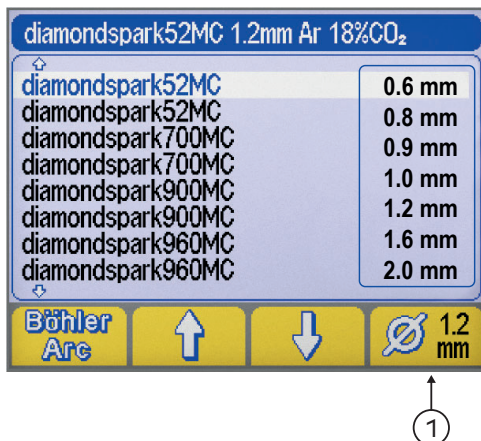

- 1 Langan halkaisija

Otsikkorivi

Mahdollistaa tiettyjen tärkeiden tietojen näytön valitusta prosessista.

EI OHJELMAA

Ilmaisee, että valittua synergiaohjelmaa ei ole saatavana tai se ei ole yhdenmukainen järjestelmän muiden asetusten kanssa.

5. SETUP

5.1 Set up ja parametrien säätö

Sen avulla voidaan suorittaa lisäparametrien asetus ja säätö hitsauslaitteen käytön helpottamiseksi ja tarkentamiseksi. Set up parametrit on järjestetty valitun hitsausmenetelmän mukaisesti, ja niillä on numeerinen koodi.

Set up:iin pääsy





- ▶ Paina 5 sekuntia kooderinäppäintä.
- ▶ Avaus vahvistetaan näytöllä näkyvällä 0-merkillä.

Halutun parametrin valinta ja säätö

- ▶ käännä kooderia, kunnes haluttua parametria vastaava numerokoodi tulee näkyviin.
- ▶ Kun nyt painetaan kooderi-näppäintä, saadaan näyttöön valitun parametrin asetusarvo ja säätö.

Poistuminen set up'ista

- ▶ säätö lohkoista poistutaan painamalla uudelleen kooderi-näppäintä.
- ▶ Set up'ista poistutaan siirtymällä parametrin "0" kohdalle (tallenna ja poistu) painaen kooderi-näppäintä.
- ▶ Vahvista toiminto painamalla painiketta .
- ▶ Muutos tallennetaan ja asetustilasta poistutaan painamalla näppäintä: .

5.1.1 Set up parametrien luettelo (MMA)

0
Tallenna ja poistu

Sen avulla voidaan tallentaa muutokset ja poistua set up'ista.

1
Reset

Sen avulla kaikki parametrit voidaan asettaa uudelleen Oletusihin.

3
Hot start

Kuumakäynnistyksen (Hot start) arvon säätö puikkohitsauksessa. Sillä saadaan "kuuma" käynnistys kaaren sytytysvaiheessa, mikä helpottaa aloitustoimenpiteitä.

Emäspuikko elektrodi

Minimi	Maksimi	Oletus
0/off	500%	80%

Selluloosa elektrodi

Minimi	Maksimi	Oletus
0/off	500%	150%

CrNi-elektrodi

Minimi	Maksimi	Oletus
0/off	500%	100%

Alumiini elektrodi

Minimi	Maksimi	Oletus
0/off	500%	120%

Valurauta elektrodi

Minimi	Maksimi	Oletus
0/off	500%	100%

7

Hitsausvirta

Hitsausvirran säätö.



Minimi	Maksimi	Oletus
3 A	Imax	100 A

8

Arc force

Kaaritehon (Arc force) arvon säätö puikkohitsauksessa.

Sen avulla hitsauksessa saadaan energinen dynaaminen vastus, mikä tekee hitsaamisen helpoksi.

Kaarivoiman arvon lisääminen vähentää elektrodin tarttumisriskiä.

**Emäspuikko elektrodi**

Minimi	Maksimi	Oletus
0/off	500%	30%

Selluloosa elektrodi

Minimi	Maksimi	Oletus
0/off	500%	350%

CrNi-elektrodi

Minimi	Maksimi	Oletus
0/off	500%	30%

Alumiini elektrodi

Minimi	Maksimi	Oletus
0/off	500%	100%

Valurauta elektrodi

Minimi	Maksimi	Oletus
0/off	500%	70%

204

Dynamic power control (DPC)

Mahdollistaa halutun V/I-käyrän valinnan.

**I=C Vakiovirta**

Kaaren korkeuden lisäämisellä tai vähentämisellä ei ole vaikutusta vaadittavaan hitsausvirtaan.

Suositellaan elektrodille: Emäspuikko, Rutiili, Haponkestävä puikko, Teräs, Valurauta

1÷20 Laskevan rampin ohjaus

Kaaren korkeuden lisääminen aiheuttaa hitsausvirran pienenemisen (ja päinvastoin) annetun arvon mukaisesti välillä 1 - 20 ampeeria voltilla.

Suositellaan elektrodille: Selluloosa, Alumiini

P=C VakiotehoKaaren korkeuden lisääminen aiheuttaa hitsausvirran pienenemisen (ja päinvastoin) seuraavan kaavan mukaisesti: $V \cdot I = K$

Suositellaan elektrodille: Selluloosa, Alumiini

312

Valokaaren irrotusjännite

Voidaan asettaa jännitteen arvo, jossa sähköinen valokaari sammuu.

Helpottaa toimintoja eri olosuhteissa.

Esimerkiksi pistehitsausvaiheessa, valokaaren alhaisen irrotusjännitteen ansiosta liekki sammuu vähemmän elektrodin irtaantuessa kappaleesta. Näin roiskeet, palamiset ja kappaleen hapettuminen ovat vähäisempiä.

Korkeaa jännitettä vaativia elektrodeja käytettäessä, tulee sen sijaan asettaa korkea raja, jotta valokaari ei sammua hitsauksen aikana.



Älä koskaan aseta generaattorin tyhjäkäyntijännitettä korkeampaa irrotusjännitettä.

Emäspuikko elektrodi

Minimi	Maksimi	Oletus
0/off	99.9 V	57.0 V

Selluloosa elektrodi

Minimi	Maksimi	Oletus
0/off	99.9 V	70.0 V

399

Leikkausnopeus

Mahdollistaa hitsausnopeuden asettamisen.

Default cm/min: referenssinopeus käsin hitsattaessa.

Syn: Sinergic arvo.



Minimi	Maksimi	Oletus
1 cm/min	200 cm/min	15 cm/min

500 Laitteen asetus

Mahdollistaa halutun graafisen käyttöliittymän valinnan.
Mahdollistaa pääsyn korkeammille asetustasoille.
Katso kappale "Käyttöliittymän mukauttaminen (Set up 500)"

Arvo	Käyttöliittymä	Arvo	Valittu taso
XE	Easy-toiminto	USER	Käyttäjä
XA	Advanced-toiminto	SERV	Service
XP	Professional-toiminto	vaBW	vaBW

551 Lock/unlock

Mahdollistaa paneelin säätimien lukitsemisen ja salasanan asettamisen.
Katso kappale "Lock/unlock (Set up 551)".

552 Summerin ääni

Summerin äänen säätö.

Minimi	Maksimi	Oletus
0/off	10	10

601 Säätöaskel

Mahdollistaa parametrin säädön käyttäjän haluamin säätöaskelin.

Minimi	Maksimi	Oletus
1	Imax	1

602 Ulkoinen parametri CH1, CH2, CH3, CH4

Mahdollistaa ulkoisen parametrin 1, 2, 3, 4 (minimiarvo, Maksimiarvo, Oletus, valittu parametri).
Katso kappale "Ulkoisten säätimien hallinta (Set up 602)".

705 Piirin resistanssin kalibrointi

Mahdollistaa järjestelmän kalibroinnin.
Katso kappale "Piirin resistanssin kalibrointi (set up 705)".

751 Virtalukema

Mahdollistaa hitsausvirran todellisen arvon näytön.

752 Jännitelukema

Mahdollistaa hitsausjännitteen todellisen arvon näytön.

768 Lämmöntuoton arvo HI

Mahdollistaa hitsauksen lämmöntuoton mittausrvon lukemisen.

801 Suojarajat

Mahdollistaa varoitusrajojen ja suojarajojen asettamisen.
Mahdollistaa hitsausprosessin hallinnan asettamalla varoitusrajat ja suojarajat tärkeimmille mitattaville parametreille.
Mahdollistaa eri hitsausvaiheiden tarkan säädön.
Katso kappale "Suojarajat (Set up 801)".

5.1.2 Asetusparametrien (TIG) luettelo
0 Tallenna ja poistu

Sen avulla voidaan tallentaa muutokset ja poistua set up'ista.

1 Reset

Sen avulla kaikki parametrit voidaan asettaa uudelleen Oletusihin.

7 Hitsausvirta

Hitsausvirran säätö.

Minimi	Maksimi	Oletus
3 A	Imax	100 A

399 Leikkausnopeus

Mahdollistaa hitsausnopeuden asettamisen.

Default cm/min: referenssinopeus käsin hitsattaessa.

Syn: Sinergic arvo.

Minimi	Maksimi	Oletus
1 cm/min	200 cm/min	10 cm/min

500 Laitteen asetus

Mahdollistaa halutun graafisen käyttöliittymän valinnan.

Mahdollistaa pääsyn korkeammille asetustasoille.

Katso kappale "Käyttöliittymän mukauttaminen (Set up 500)"

Arvo	Käyttöliittymä
XE	Easy-toiminto
XA	Advanced-toiminto
XP	Professional-toiminto

Arvo	Valittu taso
USER	Käyttäjä
SERV	Service
vaBW	vaBW

551 Lock/unlock

Mahdollistaa paneelin säätimien lukitsemisen ja salasanan asettamisen.

Katso kappale "Lock/unlock (Set up 551)".

552 Summerin ääni

Summerin äänen säätö.

Minimi	Maksimi	Oletus
0/off	10	10

601 Säätöaskel

Mahdollistaa parametrin säädön käyttäjän haluamin säätöaskelin.

Minimi	Maksimi	Oletus
1	Imax	1

602 Ulkoinen parametri CH1, CH2, CH3, CH4

Mahdollistaa ulkoisen parametrin 1, 2, 3, 4 (minimi-arvo, Maksimi-arvo, Oletus, valittu parametri).

Katso kappale "Ulkoisten säätimien hallinta (Set up 602)".

705 Piirin resistanssin kalibrointi

Mahdollistaa järjestelmän kalibroinnin.

Katso kappale "Piirin resistanssin kalibrointi (set up 705)".

751 Virtalukema

Mahdollistaa hitsausvirran todellisen arvon näytön.

752 Jännitelukema

Mahdollistaa hitsausjännitteen todellisen arvon näytön.

758
Robotin liikenopeus

Mahdollistaa robotin tai automaatiolaitteen varren liikenopeuden näytön.

768
Lämmöntuoton arvo HI

Mahdollistaa hitsauksen lämmöntuoton mittausarvon lukemisen.

801
Suojarajat

Mahdollistaa varoitusrajojen ja suojarajojen asettamisen.

Mahdollistaa hitsausprosessin hallinnan asettamalla varoitusrajat ja suojarajat tärkeimmille mitattaville parametreille.

Mahdollistaa eri hitsausvaiheiden tarkan säädön.

Katso kappale "Suojarajat (Set up 801)".

5.1.3 Asetusparametrien (MIG/MAG) luettelo
0
Tallenna ja poistu

Sen avulla voidaan tallentaa muutokset ja poistua set up'ista.

1
Reset

Sen avulla kaikki parametrit voidaan asettaa uudelleen Oletusihin.

2
Hitsausohjelmat

MIG/MAG Standard:

Mahdollistaa manuaalisen MIG (Off) tai synergisen MIG (6) prosessin valinnan asettamalla hitsattava materiaali.

Pulssitettu MIG/MAG:

 Mahdollistaa synergisen MIG (6) prosessin valinnan asettamalla hitsattava materiaali.
 Mahdollistaa CC/CV prosessin.

3
Langan nopeus

Mahdollistaa langan syöttönopeuden säädön.

Minimi	Maksimi	Oletus
0.5 m/min	22.0 m/min	-

4
Virta

Hitsausvirran säätö.

Minimi	Maksimi
3 A	I _{max}

5
Kappaleen paksuus

Mahdollistaa hitsattavan osan paksuuden asettamisen.

Mahdollistaa järjestelmän asettamisen hitsattavan osan säätöihin.

6
Kulmapalko "a"

Mahdollistaa palon syvyyden valinnan kulmahitsiä varten.

10
Kaasun esivirtaus

Sen avulla voidaan asettaa ja säätää kaasun virtaus ennen valokaaren sytytystä.

Sen avulla voidaan ladata kaasu polttimeen ja valmistella työskentelytila hitsausta varten.

Minimi	Maksimi	Oletus
0/off	99.9 s	0.1 s

11 Soft start

Sen avulla voidaan säätää langansyöttönopeus sytytystä edeltävissä vaiheissa. Mahdollistaa hitaamman aloituksen, joka on pehmeämpi ja lähes roiskeeton.

Minimi	Maksimi	Oletus
10 %	100 %	50 %

12 Moottorin ramppi

Sen avulla voidaan asettaa asteittainen kulku langan nopeuden välille sytytyksessä ja hitsauksessa.

Minimi	Maksimi	Oletus
0/off	1.0 s	0/off

15 Burn back

Sen avulla voidaan säätää langan palamisnopeus, estäen kiinnitarttumisen hitsauksen lopussa. Polttimen ulkopuolisen langan pituutta voidaan säätää.

Minimi	Maksimi	Oletus
-2.00	+2.00	0/syn

16 Kaasun jälkivirtaus

Kaasun virtauksen säätö hitsaustapahtuman lopussa.

Minimi	Maksimi	Oletus
0/off	99.9 s	2.0 s

19 Duty cycle (kaksoispulssi)

Mahdollistaa loppuvirran pitoajan asettamisen.

Minimi	Maksimi	Oletus
10 %	90 %	50 %

20 Kaksoispulssitus

Mahdollistaa pulssiampplitudin säädön.

Minimi	Maksimi	Oletus
0 %	100 %	±25 %

Minimi	Maksimi	Oletus
0.5 m/min	22 m/min	2.5 m/min

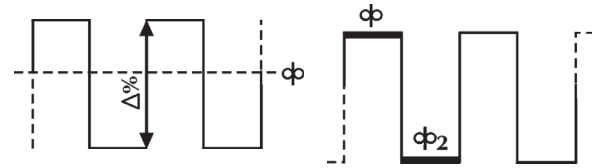
**21 Pulssitaajuus (kaksoispulssi)**

Mahdollistaa jakson, eli pulssin toistosyklin, säädön. Mahdollistaa pulssitaajuuden säädön.

Minimi	Maksimi	Oletus
0.1 Hz	5.0 Hz	2.0 Hz

22 Toisiojännite (kaksoispulssi)

Mahdollistaa toisen pulssitasojännitteen säädön. Mahdollistaa vakaamman kaaren saavuttamisen eri pulssivaiheissa.

Minimi	Maksimi	Oletus
-5.0	+5.0	0/syn

23 Pulssi-slope (kaksoispulssi)

Mahdollistaa ramppiajan asetuksen pulssihitsauksessa.

Minimi	Maksimi	Oletus
1 %	100 %	50 %

24 Bilevel (4T - crater filler)

Kaksitasoisen langan nopeus bilevel-hitsausmuodossa.

Jos hitsaaja painaa liipasinta ja vapauttaa sen taas nopeasti, siirrytään "φ₂"-een.

Painamalla ja vapauttamalla liipasinta nopeasti, siirrytään taas "φ"-een, j.n.e.

Minimi	Maksimi	Oletus
1 %	200 %	0/off

25 Alkuaskel

Mahdollistaa langan nopeuden säädön hitsauksen ensimmäisen "kraatterintäyttövaiheen" aikana. Mahdollistaa osaan kohdistuvan energiamäärän lisäämisen, kun (edelleen kylmä) materiaali vaatii enemmän lämpöä sulaakseen tasaisesti.

Minimi	Maksimi	Oletus
20 %	200 %	120 %

26 Crater filler

Mahdollistaa langan nopeuden säädön hitsauksen loppuvaiheessa. Mahdollistaa osaan kohdistuvan energiamäärän pienentämisen vaiheessa, jolloin materiaali on jo hyvin kuumaa, ja näin ei-toivottujen muodonmuutosten vähentämisen.

Minimi	Maksimi	Oletus
20 %	200 %	80 %

27 Alkuaskelen aika



Mahdollistaa alkuaskelen ajan asettamisen. Mahdollistaa "kraatterintäytön" automatisoinnin.

Minimi	Maksimi	Oletus
0.1 s	99.9 s	0/off

28 Kraatterin täyttöaika

Mahdollistaa "kraatterin täyttöajan" asettamisen. Mahdollistaa "kraatterintäytön" automatisoinnin.

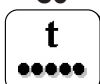
Minimi	Maksimi	Oletus
0.1 s	99.9 s	0/off

30 Pistehitsaus

Mahdollistaa "pistehitsausprosessin" käytön ja hitsausajan asettamisen.

Minimi	Maksimi	Oletus
0.1 s	99.9 s	0/off

31 Pysähdyspiste

Sen avulla voidaan käynnistää "pysähdyspiste" sekä määritellä hitsausten välinen tauko-aika.

Minimi	Maksimi	Oletus
0.1 s	99.9 s	0/off

32 Toisiojännite (Bilevel MIG)

Mahdollistaa toisen pulssitaso jännitteen säädön. Mahdollistaa vakaamman kaaren saavuttamisen eri pulssivaiheissa.

Minimi	Maksimi	Oletus
-5.0	+5.0	0/syn

33 Toisioinduktanssi (Bilevel MIG)

Mahdollistaa toisen pulssitaso induktanssi säädön. Mahdollistaa nopeamman tai hitaamman kaaren saavuttamisen hitsaajan liikkeen ja hitsauksen luonnollisen epävakauden kompensoimiseksi.

Matala induktanssi = herkästi reagoiva kaari (enemmän roiskeita).
 Korkea induktanssi = hitaammin reagoiva kaari (vähemmän roiskeita).

Minimi	Maksimi	Oletus
-30	+30	0/syn

34 Aloitusvirran nousu

Asettaa aloitusvirran asteittaisen kasvun hitsausvirtaan.

Minimi	Maksimi	Oletus
0 s	10 s	0/off

35 Kraatterin täyttöaika

Asettaa asteittaisen siirtymisen hitsausvirrasta kraatterintäyttövirtaan.

Minimi	Maksimi	Oletus
0 s	10 s	0/off

202 Induktanssi

Mahdollistaa hitsauspiirin sarjainduktanssin elektronisen säädön.

Mahdollistaa nopeamman tai hitaamman kaaren saavuttamisen hitsaajan liikkeiden ja hitsauksen luonnollisen epävakauden kompensoimiseksi.

Matala induktanssi = herkästi reagoiva kaari (enemmän roiskeita).

Korkea induktanssi = hitaammin reagoiva kaari (vähemmän roiskeita).

Minimi	Maksimi	Oletus
-30	+30	0/syn

331 Kompensoitu keskijännite

Mahdollistaa hitsausjännitteen asettamisen.

398 Siirtonopeuden referenssivakio

Kaikkien hitsausprosessien referenssivakio

Siirtonopeusarvo polttimelle, johon järjestelmä viittaa hitsausparametrien laskelmia varten

399 Leikkausnopeus

Mahdollistaa hitsausnopeuden asettamisen.

Default cm/min: referenssinopeus käsin hitsattaessa.

Syn: Sinergic arvo.

Minimi	Maksimi	Oletus
syn min	syn max	35 cm/min

500 Laitteen asetus

Mahdollistaa halutun graafisen käyttöliittymän valinnan.

Mahdollistaa pääsyn korkeammille asetustasoille.

Katso kappale "Käyttöliittymän mukauttaminen (Set up 500)"

Arvo	Käyttöliittymä
XE	Easy-toiminto
XA	Advanced-toiminto
XP	Professional-toiminto

Arvo	Valittu taso
USER	Käyttäjä
SERV	Service
vaBW	vaBW

551 Lock/unlock

Mahdollistaa paneelin säätimien lukitsemisen ja salasanan asettamisen.

Katso kappale "Lock/unlock (Set up 551)".

552 Summerin ääni

Summerin äänen säätö.

Minimi	Maksimi	Oletus
0/off	10	10

601 Säätöaskel

Mahdollistaa parametrin säädön käyttäjän haluamien säätöaskelin.

Toimintaa ohjataan polttimen ylös / alas-painikkeella.

Minimi	Maksimi	Oletus
1	Imax	1

602 Ulkoinen parametri CH1, CH2, CH3, CH4

Mahdollistaa ulkoisen parametrin 1, 2, 3, 4 (minimiarvo, Maksimiarvo, Oletus, valittu parametri).

Katso kappale "Ulkoisten säätimien hallinta (Set up 602)".

606 U/D torch

Mahdollistaa ulkoisen parametrin (U/D).

Arvo	Oletus	Soittotoiminto
0/off	-	off
1/I1	X	Virta
	-	Ohjelman hakeminen

612 DgMig-polttimen asetus

Mahdollistaa digitaalisen polttimen kanavien hallinnan.

Arvo	Oletus	Soittotoiminto
0/off	-	off
1/I1	-	Virta
2/ 	-	Ohjelman hakeminen
3/CH3	-	CH3
4/CH4	-	CH4
5/STD	X	STD

653 Langan nopeus

Mahdollistaa langan syöttönopeuden säädön (kuormauksen aikana vaiheen).

Minimi	Maksimi	Oletus
0.5 m/min	22.0 m/min	3.0 m/min

705 Piirin resistanssin kalibrointi

Mahdollistaa järjestelmän kalibroinnin.

Katso kappale "Piirin resistanssin kalibrointi (set up 705)".

751 Virtalukema

Mahdollistaa hitsausvirran todellisen arvon näytön.

752 Jännitelukema

Mahdollistaa hitsausjännitteen todellisen arvon näytön.

755 Kaasuvirtauksen lukema

Mahdollistaa kaasun todellisen virtauksen näytön.

757 Langan nopeus

Moottorin 1 kooderin lukema.

758 Robotin liikenopeus

Mahdollistaa robotin tai automaatiolaitteen varren liikenopeuden näytön.

760 Virtalukema (moottori 1)

Mahdollistaa moottorin todellisen arvon näytön (moottori 1).

768

Lämmöntuoton arvo HI

Mahdollistaa hitsauksen lämmöntuoton mittausarvon lukemisen.



770

Hitsiaineentuoton arvo

Näyttää hitsiaineentuoton arvon.



801

Suojarajat

Mahdollistaa varoitusrajojen ja suojarajojen asettamisen.

Mahdollistaa hitsausprosessin hallinnan asettamalla varoitusrajat ja suojarajat tärkeimmille mitattaville parametreille.

Mahdollistaa eri hitsausvaiheiden tarkan säädön.

Katso kappale "Suojarajat (Set up 801)".



5.2 Parametrien erityiset käyttötoimenpiteet

5.2.1 7-segmenttinäytön mukauttaminen

Mahdollistaa parametrin arvon jatkuvan näytön 7-segmenttinäytöllä.

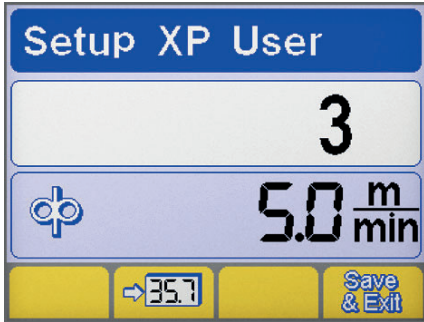

- ▶ Siirry set-up-tilaan painamalla säätönupin painiketta vähintään 5 sekunnin ajan.
- ▶ Valitse tarvittava parametri kiertämällä säätönuppia.
- ▶ Tallenna valittu parametri 7-segmenttinäyttöön painamalla painiketta .
- ▶ Tallenna ja poistu nykyiseltä näytöltä painamalla painiketta .

5.2.2 Käyttöliittymän mukauttaminen (Set up 500)

Mahdollistaa parametrien mukauttamisen päävalikossa.

500

Laitteen asetus

Mahdollistaa halutun graafisen käyttöliittymän valinnan.



Arvo	Käyttöliittymä
XE	Easy-toiminto
XA	Advanced-toiminto
XP	Professional-toiminto

TOIMINTO XE

MIG/MAG

Hitsausparametrit

Toiminnot

TOIMINTO XA

MIG/MAG

Hitsausparametrit

Toiminnot

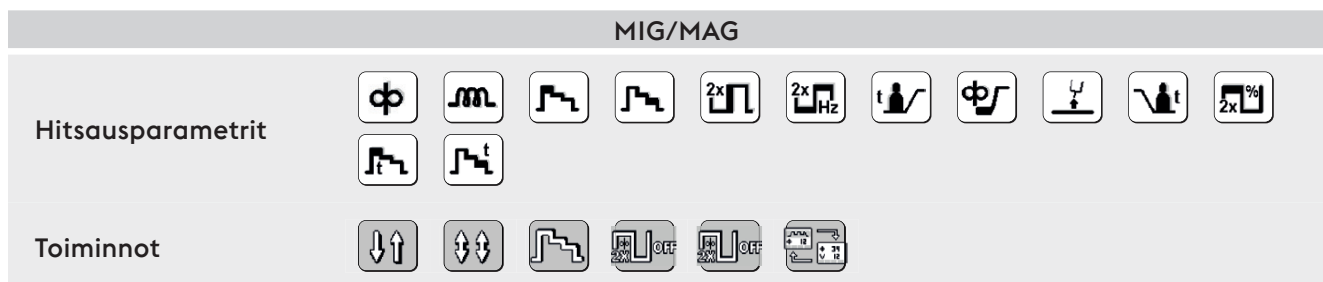
TOIMINTO XP

5.2.3 Lock/unlock (Set up 551)

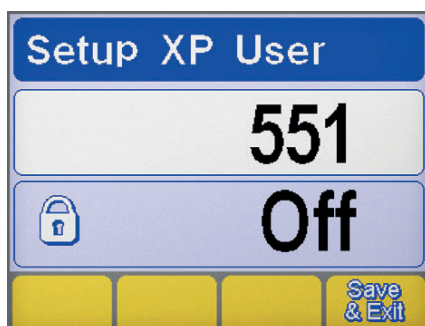
Mahdollistaa paneelin säätimien lukitsemisen ja salasanan asettamisen.

Parametrin valinta

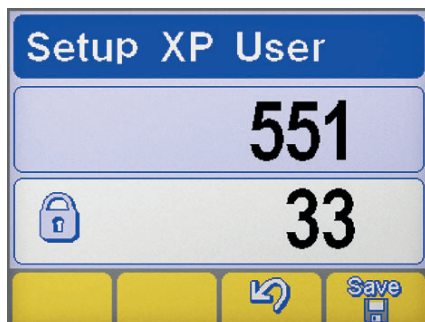
- ▶ Siirry set-up-tilaan painamalla säätönupin painiketta vähintään 5 sekunnin ajan.
- ▶ Valitse haluttu parametri (551).
- ▶ Aktivoi valitun parametrin säätö painamalla säätönupin painiketta.

Salasanan asetus

- ▶ Aseta numerokoodi (salasana) kiertämällä säätönuppia.
- ▶ Vahvista toimenpide painamalla kooderinäppäintä.
- ▶ Vahvista toiminto painamalla painiketta .
- ▶ Tallenna muutos painamalla painiketta: .

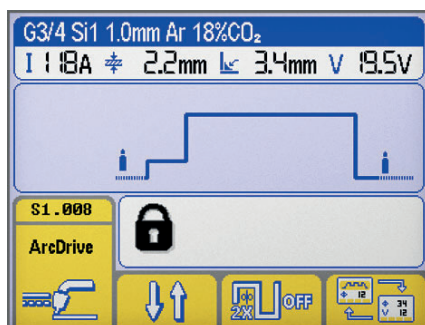
Paneelin toiminnot

- ▶ Voit vapauttaa toiminnot tilapäisesti (5 minuutiksi) antamalla oikean salasanan säätönuppia kiertämällä.
- ▶ Vahvista toimenpide painamalla kooderinäppäintä.
- ▶ Voit vapauttaa ohjauspaneelin kokonaan siirtymällä set-up-tilaan (seuraa edellä annettuja ohjeita) ja palauttamalla parametrin 551 arvoksi "off".
- ▶ Vahvista toimenpide painamalla kooderinäppäintä.
- ▶ Tallenna muutos painamalla painiketta: .

5.2.4 Ulkoisten säätimien hallinta (Set up 602)

Mahdollistaa ulkoisen parametrin 2 (minimiarvo, Maksimiarvo, Oletus, valittu parametri).

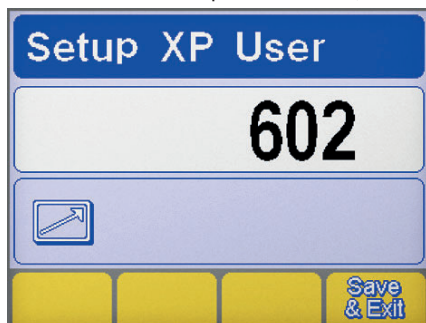
Parametrin valinta

- ▶ Siirry set-up-tilaan painamalla säätönupin painiketta vähintään 5 sekunnin ajan.
- ▶ Valitse haluttu parametri (602).
- ▶ Siirry "Ulkoisten säätimien hallinta" -näytölle painamalla säätönupin painiketta.

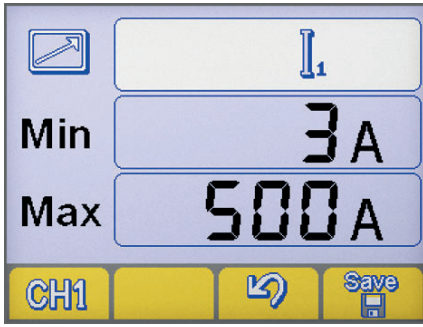

Ulkoisten säätimien hallinta

- ▶ Valitse haluttu RC-kauko-ohjauslähtö (CH1, CH2, CH3, CH4) painamalla painiketta.
- ▶ Valitse haluttu parametri (Min-Max-parametri) painamalla säätönupin painiketta.
- ▶ Säädä haluttu parametri (Min-Max-parametri) kiertämällä säätönuppia.
- ▶ Tallenna muutos painamalla painiketta:
- ▶ Vahvista toiminto painamalla painiketta

5.2.5 Piirin resistanssin kalibrointi (set up 705)

Mahdollistaa virtalähteen kalibroinnin hitsauspiirin nykyisen vastuksen mukaan.

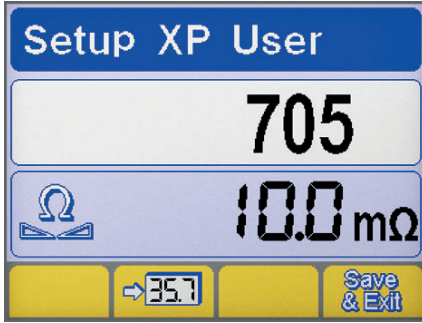

Parametrin valinta

- ▶ Siirry set-up-tilaan painamalla säätönupin painiketta vähintään 5 sekunnin ajan.
- ▶ Valitse haluttu parametri (705).
- ▶ Aktivoi valitun parametrin säätö painamalla säätönupin painiketta.
- ▶ Kytke virtalähde hitsauspiiriin (pöytä tai kappale).
- ▶ Poista suojahattu paljastaaksesi polttimen suuttimen kärjen. (MIG/MAG)

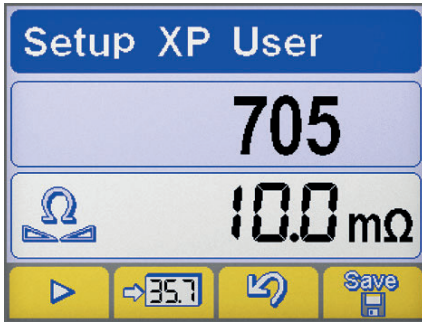

Kalibrointi

- ▶ Aseta langanohjaimen kärki sähköiseen kosketukseen työkappaleen kanssa. (MIG/MAG)
- ▶ Paina -painiketta aloittaaksesi toimenpiteen.
- ▶ Säilytä kosketus vähintään sekunnin ajan.
- ▶ Näytöllä näkyvä arvo päivitetään, kun kalibrointi on suoritettu.
- ▶ Vahvista toiminto painamalla painiketta
- ▶ Vahvista toiminto painamalla painiketta
- ▶ Muutos tallennetaan ja asetustilasta poistutaan painamalla näppäintä:

5.2.6 Suojarajat (Set up 801)

Mahdollistaa varoitusrajojen ja suojarajojen asettamisen.

Mahdollistaa hitsausprosessin hallinnan asettamalla varoitusrajat ja suojarajat tärkeimmille mitattaville parametreille.

Mahdollistaa eri hitsausvaiheiden tarkan säädön.

Katso kappale "Suojarajat (Set up 801)".

Huomiotasot				Suojarajat			
	Hitsausvirta				Hitsausjännite		
	Kaasuvirtauksen lukema				Robotin liikenopeus		
	Virtalukema (moottori 1)				Virtalukema (moottori 2)		
	Jäähdytysnesteen virtauslukema				Langan nopeus		
	Jäähdytysnesteen lämpötila lukema						

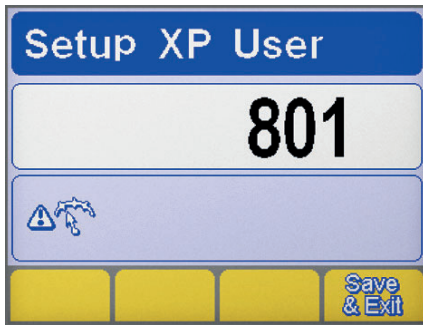
Parametrin valinta

- ▶ Siirry set-up-tilaan painamalla säätönupin painiketta vähintään 5 sekunnin ajan.
- ▶ Valitse haluttu parametri (801).
- ▶ Siirry "Suojarajat"-näytölle painamalla säätönupin painiketta.

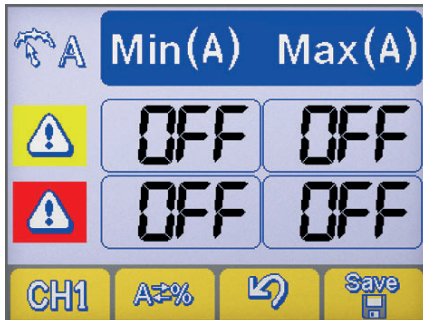
Parametrin valinta

- ▶ Valitse tarvittava parametri painamalla painiketta **CH1**.
- ▶ Valitse suojarajojen asetustapa painamalla painiketta **A=%**.

Laitteen asetus

Absoluuttinen arvo

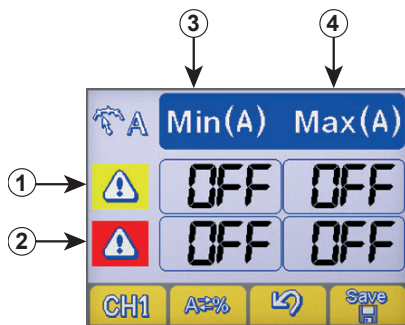

Prosenttiarvo

Turvallisuusrajojen asetus

- 1 Varoitusrajojen rivi
- 2 Häytysrajojen rivi
- 3 Minimiarvojen sarake
- 4 Maksimiarvojen sarake

- ▶ Valitse haluamasi ruutu painamalla säätönupin painiketta (valittu ruutu vaihtuu käänteisen väriseksi).
- ▶ Säädä valitun parametrin taso kiertämällä säätönuppia.
- ▶ Tallenna muutos painamalla painiketta: **Save**.



Jonkin varoitusrajan ylittyminen aiheuttaa ohjauspaneeliin visuaalisen ilmoituksen.



Jonkin varoitusrajan ylittyminen aiheuttaa ohjauspaneeliin visuaalisen ilmoituksen ja hitsaustoiminnot keskeytyvät välittömästi.

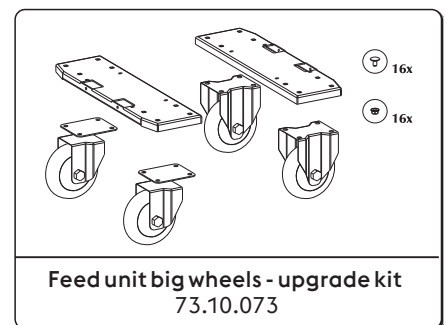
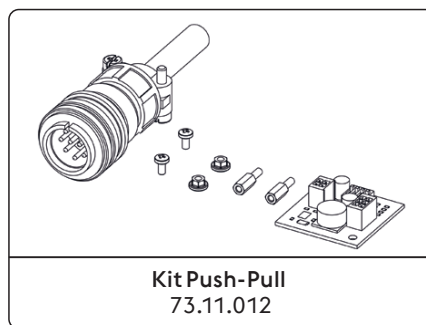
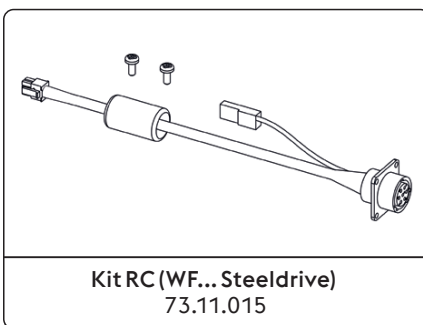

On mahdollista asettaa hitsaussuodattimien alku ja loppu, jotta virhesignaalit saadaan estettyä kaaren sytytyksen ja sammutuksen aikana. (katso kappale "Set up" - parametrit 802-803-804).

6. LISÄVARUSTEET

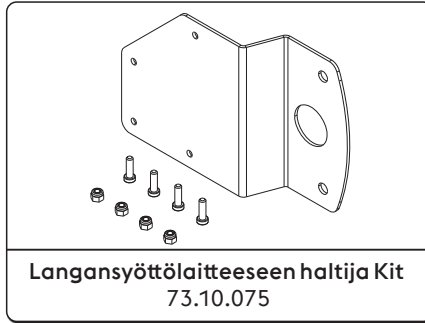
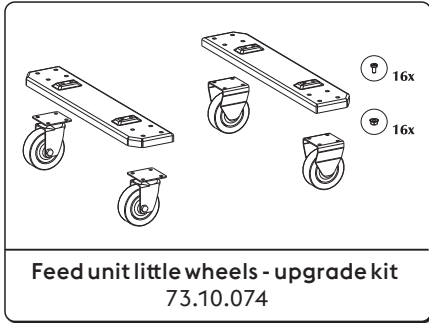

*Tehtaan kokoonpano
Katso kappale "Asennus kit/lisävarusteet".

7. HUOLTO



Laitteessa tulee suorittaa normaalihuolto valmistajan antamien ohjeiden mukaisesti. Kun laite on toimiva, kaikki laitteen suojapellit ja luukut on suljettava. Laitteeseen ei saa tehdä minkäänlaisia muutoksia. Estä metallipölyä kasaantumasta lähelle tuuletusaukkoja tai niiden päälle.



Huoltotoimia voi tehdä vain niihin pätevöitynyt henkilö. Takuun voimassaolo lakkaa, mikäli valtuuttamattomat henkilöt ovat suorittaneet laitteen korjaus- tai osien vaihtotoimenpiteitä. Ainoastaan ammattitaitoiset teknikot saavat suorittaa laitteen mahdolliset korjaus- tai osien vaihtotoimenpiteet.



Irrota laite sähköverkosta ennen huoltotoimenpiteitä.

7.1 Suorita seuraavat määräaikaiset tarkastukset virtalähteelle



Puhdista virtalähde sisältä matalapaineisella paineilmasuihkulla ja pehmeällä harjalla. Tarkista sähköiset kytkennät ja kytkentäkaapelit.

7.2 Räspundere



Ellei huoltoa suoriteta, kaikkien takuiden voimassaolo lakkaa eikä valmistaja vastaa aiheutuneista vahingoista. Valmistaja ei vastaa vahingoista, jotka ovat aiheutuneet siitä, ettei ylläolevia ohjeita ole noudatettu. Jos sinulla on epäselvyyksiä tai ongelmia, älä epäröi ottaa yhteyttä lähimpään huoltokeskukseen.

8. HÄLYTYSKOODIT



HÄLYTYS

Hälytyksen laukeamisesta tai kriittisen turvallisuusrajan ylityksestä ilmoitetaan ohjauspaneelin merkkivalolla. Se aiheuttaa hitsaustoimenpiteiden välittömän eston.



HUOMIO

Turvallisuusrajan ylityksestä ilmoitetaan ohjauspaneelin merkkivalolla. Se ei estä hitsaustoimenpiteiden jatkamista.

Seuraavassa luetellaan kaikki järjestelmää koskevat hälytykset ja turvallisuusrajat.

	E01	Ylikuumentuminen	
--	-----	------------------	--

	E02	Ylikuumentuminen	
--	-----	------------------	--

	E05	Ylivirta	
--	-----	----------	--

	E07	Langansyöttölaitteen moottorin sähköjärjestelmän vika	
--	-----	---	--



























	E08	Estetty moottori	
--	-----	------------------	--

	E10	Tehomodulin ylivirta (Inverter)	
--	-----	---------------------------------	--

	E12.1	Yhteysvirhe WF1	
--	-------	-----------------	--

	E13	Yhteysvirhe (FP)	
--	-----	------------------	--

 E14.xx	Virheellinen ohjelma virheen alakoodi ilmoittaa poistetun työohjelman numeron		 E15	Virheellinen ohjelma	
 E16.1	Yhteysvirhe RI 1000/2000/3000 (CAN bus)		 E16.2	Yhteysvirhe RI 3000 (Modbus)	
 E16.3	Yhteysvirhe RI 1000/2000		 E18.xx	Virheellinen ohjelma virheen alakoodi ilmoittaa poistetun työohjelman numeron	
 E19	Järjestelmän konfigurointivirhe		 E19.1	Järjestelmän konfigurointivirhe	
 E19.11	Järjestelmän konfigurointivirhe (WF)		 E20	Muistivirhe	
 E21	Datan menetys		 E23	Hitsausohjelmat puuttuvat	
 E27	Muistivirhe (RTC)		 E32	Datan menetys	
 E33.1	Järjestelmän konfigurointivirhe (LCD 3.5")		 E33.3	Yhteysvirhe (ACTIVATION KEY)	
 E33.4	Yhteysvirhe (ACTIVATION KEY)		 E40	Laitteen sähkönsyötön vika	
 E43	Jäähdytysneste puuttuu		 E44	Kaasu puuttuu	
 E48	Lanka puuttuu (Automaatio ja robotiikka)		 E50	Lanka juuttunut (Automaatio ja robotiikka)	
 E54	Virtataso ylittynyt (Alaraja)		 E55	Virtataso ylittynyt (Yläraja)	
 E56	Jännitetaso ylittynyt (Alaraja)		 E57	Jännitetaso ylittynyt (Yläraja)	
 E58	Kaasun virtaustaso ylittynyt (Alaraja)		 E59	Kaasun virtaustaso ylittynyt (Yläraja)	
 E62	Virtataso ylittynyt (Alaraja)		 E63	Virtataso ylittynyt (Yläraja)	
 E64	Jännitetaso ylittynyt (Alaraja)		 E65	Jännitetaso ylittynyt (Yläraja)	
 E66	Kaasun virtaustaso ylittynyt (Alaraja)		 E67	Kaasun virtaustaso ylittynyt (Yläraja)	

 E71	Jäähdytysnesteen ylikuumentuminen		 E74	Moottorin 1 virtataso ylittynyt	
 E76	Jäähdytysnesteen virtaustaso ylittynyt		 E77	Jäähdytysnesteen lämpötilataso	
 E80	Lanka puuttuu (wire end)		 E81	Ylivirta (WU-pumppu)	
 E82	Yhteysvirhe (WU)		 E83	Pumppu pysähtynyt	
 E99.2	Järjestelmän konfigurointihälytys (inverter)		 E99.3	Järjestelmän konfigurointihälytys (FP)	
 E99.4	Järjestelmän konfigurointihälytys (FP)		 E99.5	Järjestelmän konfigurointihälytys (FP)	
 E99.6	Järjestelmän konfigurointihälytys		 E99.11	Muistivirhe	

9. VIANMÄÄRITYS JA RATKAISUT

Langansyöttö jumissa

Syy	Toimenpide
» Polttimen liipaisin virheellinen.	» Vaihda viallinen osa. » Käänny lähimmän huoltokeskuksen puoleen laitteen korjaamista varten.
» Rullat virheelliset tai kuluneet.	» Vaihda rullat.
» Vaihdemoottori viallinen.	» Vaihda viallinen osa. » Käänny lähimmän huoltokeskuksen puoleen laitteen korjaamista varten.
» Polttimen suoja viallinen.	» Vaihda viallinen osa. » Käänny lähimmän huoltokeskuksen puoleen laitteen korjaamista varten.
» Langansyöttölaitteessa ei ole virtaa.	» Tarkista kytkentä generaattoriin. » Katso ohjeet kappaleesta "KytKentä". » Käänny lähimmän huoltokeskuksen puoleen laitteen korjaamista varten.
» Kelaus epätasaisista kelalla.	» Palauta kelan normaalitoimintaolosuhteet tai vaihda se uuteen.
» Polttimen suutin sulanut (lanka tarttunut kiinni).	» Vaihda viallinen osa.

Langansyöttö on epätasainen

Syy	Toimenpide
» Polttimen liipaisin virheellinen.	» Vaihda viallinen osa. » Käänny lähimmän huoltokeskuksen puoleen laitteen korjaamista varten.
» Rullat virheelliset tai kuluneet.	» Vaihda rullat.
» Vaihdemoottori viallinen.	» Vaihda viallinen osa. » Käänny lähimmän huoltokeskuksen puoleen laitteen korjaamista varten.
» Polttimen suoja viallinen.	» Vaihda viallinen osa. » Käänny lähimmän huoltokeskuksen puoleen laitteen korjaamista varten.

» Kelan kitka tai rullien lukituslaitteet säädetty väärin.

» Löysennä kitkaa.
» Lisää painetta rulliin.

Kuonasulkeumat

Syy

» Puutteellinen kuonanpoisto.
» Elektrodin halkaisija liian suuri.
» Reunojen valmistelu väärä.
» Hitsauksen suoritustapa väärä.

Toimenpide

» Puhdista kappaleet huolellisesti ennen hitsaamista.
» Käytä ohuempaa elektrodia.
» Paranna railomuotoa.
» Pienennä elektrodin ja kappaleen välistä etäisyyttä.
» Etene säännöllisesti kaikkien hitsausvaiheiden aikana.

Huokoisuus

Syy

» Huono kaasusuojaus.

Toimenpide

» Sääädä oikea kaasun virtaus.
» Tarkista, että polttimen hajotin ja kaasusuulake ovat hyväkuntoisia.

Takertuminen

Syy

» Pitkä valokaari.
» Hitsausparametrit väärä.
» Hitsauksen suoritustapa väärä.
» Huomattavan kokoiset hitsattavat kappaleet.
» Valokaaren dynamiikka väärä.

Toimenpide

» Lisää elektrodin ja työkappaleen välistä etäisyyttä.
» Lisää hitsausjännitettä.
» Suurena hitsausvirtaa.
» Lisää hitsausjännitettä.
» Kallista poltinta mahdollisimman paljon kulman suuntaiseksi.
» Suurena hitsausvirtaa.
» Lisää hitsausjännitettä.
» Kohota piirin induktiivista arvoa.

Reunahaavat

Syy

» Hitsausparametrit väärä.
» Pitkä valokaari.
» Hitsauksen suoritustapa väärä.
» Huono kaasusuojaus.

Toimenpide

» Pienennä hitsausvirtaa.
» Pienennä elektrodin ja kappaleen välistä etäisyyttä.
» Pienennä hitsattavien kappaleiden.
» Pienennä sivun värähtelyn nopeutta täytettäessä.
» Pienennä hitsauksen etenemisnopeutta.
» Käytä hitsattaviin materiaaleihin soveltuvia kaasuja.

Hapettuma

Syy

» Huono kaasusuojaus.

Toimenpide

» Sääädä oikea kaasun virtaus.
» Tarkista, että polttimen hajotin ja kaasusuulake ovat hyväkuntoisia.

Huokoisuus

Syy

» Rasvaa, maalia, ruostetta tai likaa hitsattavissa kappaleissa.
» Öljyinen, maalinen, ruosteinen tai likainen lisäaine.
» Kosteaa lisäaine.
» Pitkä valokaari.
» Hitsauskaasussa on kosteutta.

Toimenpide

» Puhdista kappaleet huolellisesti ennen hitsaamista.
» Käytä aina hyvälaatuisia tuotteita ja materiaaleja.
» Pidä lisäaine aina hyvässä kunnossa.
» Käytä aina hyvälaatuisia tuotteita ja materiaaleja.
» Pidä lisäaine aina hyvässä kunnossa.
» Pienennä elektrodin ja kappaleen välistä etäisyyttä.
» Pienennä hitsattavien kappaleiden.
» Käytä aina hyvälaatuisia tuotteita ja materiaaleja.
» Pidä kaasunsyöttöjärjestelmä aina hyvässä kunnossa.

» Huono kaasusuojaus.

» Hitsisulan liian nopea jähmettyminen.

» Säädä oikea kaasun virtaus.

» Tarkista, että polttimen hajotin ja kaasusuulake ovat hyväkuntoisia.

» Pienennä hitsauksen etenemisnopeutta.

» Esikumenna hitsattavat kappaleet.

» Suurena hitsausvirtaa.

Kuumahalkeamat

Syy

» Hitsausparametrit väärä.

» Rasvaa, maalia, ruostetta tai likaa hitsattavissa kappaleissa.

» Öljyinen, maalinen, ruosteinen tai likainen lisäaine.

» Hitsauksen suoritustapa väärä.

» Hitsattavat kappaleet toisistaan eroavilla ominaisuuksilla.

Toimenpide

» Pienennä hitsausvirtaa.

» Puhdista kappaleet huolellisesti ennen hitsaamista.

» Käytä aina hyvälaatuisia tuotteita ja materiaaleja.

» Pidä lisäaine aina hyvässä kunnossa.

» Suorita toimenpiteet oikeassa järjestyksessä hitsattavan sauman mukaisesti.

» Rasvaa ennen hitsaamista.

Kylmähalkeamat

Syy

» Kosteaa lisäaine.

» Hitsattavan liitoksen erikoinen muoto.

Toimenpide

» Käytä aina hyvälaatuisia tuotteita ja materiaaleja.

» Pidä lisäaine aina hyvässä kunnossa.

» Esikumenna hitsattavat kappaleet.

» Suorita jälkilämpökäsittely.

» Suorita toimenpiteet oikeassa järjestyksessä hitsattavan sauman mukaisesti.

10. KÄYTTÖOHJEET

10.1 Hitsauksesta lankaliittämällä (MIG/MAG)

Johdanto

MIG-järjestelmässä käytetään tasavirtageneraattoria, syöttökoneistoa ja puolaa, poltinta ja kaasua.

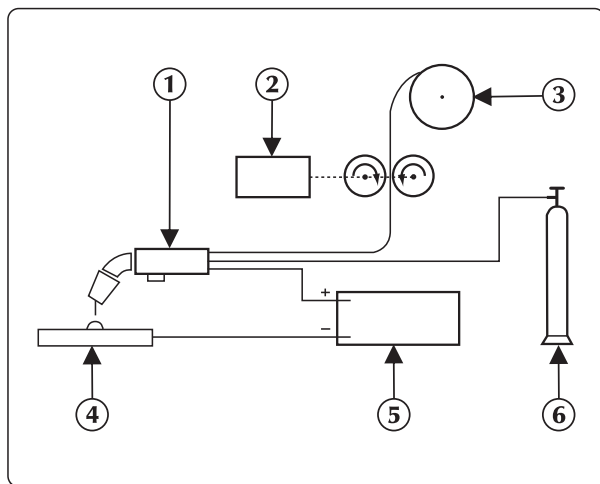

Manuaalinen hitsauslaite

Virta siirretään kaareen sulavan elektrodin kautta (lanka liitetty positiiviseen napaan);

Näin sulanut metalli siirtyy hitsattavaan palaan kaaren kautta.

Langan syöttö on tarpeellista sulaneen hitsausmateriaalin langan palauttamiseksi hitsauksen aikana.

1. Torch

2. Langansyöttölaite

3. Hitsauslanka

4. Hitsattava kappale

5. Generaattori

6. Kaasupullo

Etenemistavat

Suojakaasulla hitsattaessa tapa, jolla pisarat irtoavat elektrodista, määrittelee kaksi eri siirtotapaa.

Ensimmäinen tapa, nimeltään "SIIRTO LYHYTKAARIHITSAUKSELLE (SHORT-ARC)", saattaa elektrodin suoraan kosketukseen hitsisulan kanssa. Näin syntyy lyhytkaari, joka aiheuttaa langan sulamisen. Tällöin lanka katkeaa, jonka jälkeen kaari käynnistyy uudelleen ja jakso toistuu.

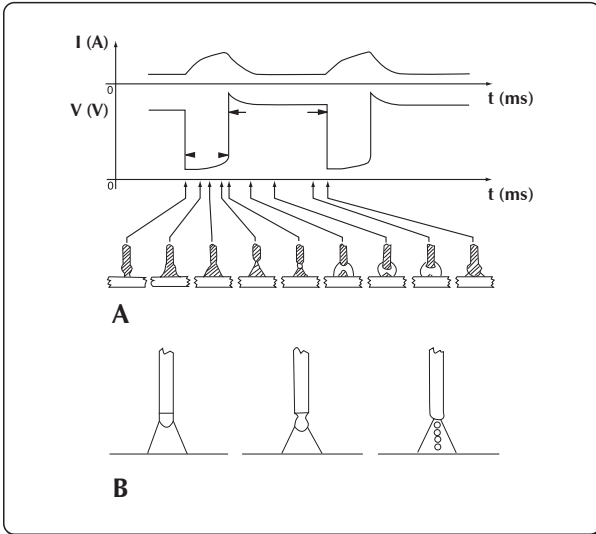

Jakso LYHYT (SHORT) ja hitsaus KUUMAKAARI (SPRAY ARC)

Toinen tapa siirtää roiskeita on "SIIRTO KUUMAKAARIHITSAUKSELLE (SPRAY-ARC)", joka mahdollistaa roiskeiden irtoamisen elektrodista ja sen jälkeen ne saavuttavat hitsisulan.

Hitsausparametrit

Kaaren näkyvyys vähentää käyttäjän tarvetta seurata jäykästi säätötaulukoita, koska hän pystyy suoraan tarkkailemaan hitsisulaa.

- Jännite vaikuttaa suoraan hitsauksen ulkonäköön, mutta hitsattavien pintojen mittasuhteet voidaan muuttaa tarpeen mukaan käyttäen poltinta manuaalisesti siten, että saadaan vaihtelevia kerrostumia vakaalla jännitteellä.
- Langan etenemisnopeus on suhteessa hitsausjännitteeseen.

Seuraavissa kahdessa kuvassa esitetään eri hitsausparametrien väliset suhteet.

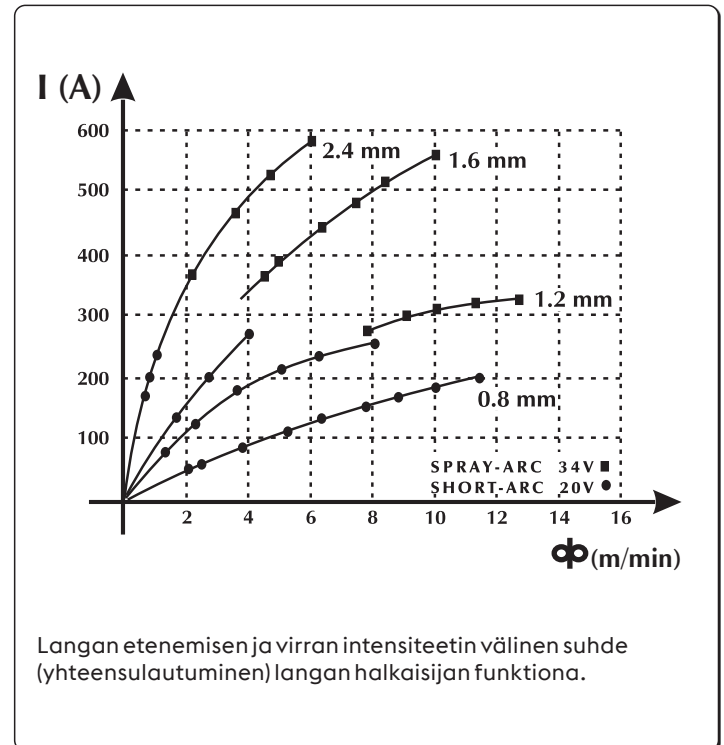
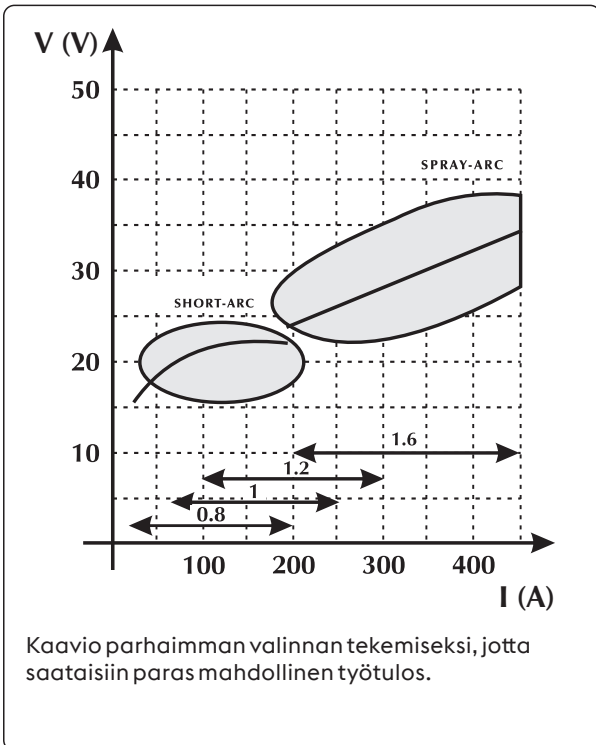

Opastava taulukko hitsausparametrien valitsemiseksi. tyypillisimmille sovelluksille ja yleisimmin käytetyille langoille

Kaaren jännite

Ø 0,8 mm

Ø 1,0-1,2 mm

Ø 1,6 mm

Ø 2,4 mm

16V - 22V
SHORT - ARC

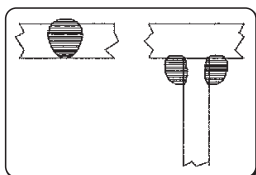

60 - 160 A

Pienten kiilojen alhainen läpäisevyys

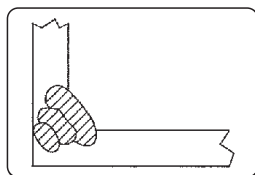

100 - 175 A

Hyvä läpäisevyyden ja sulautumisen kontrolli

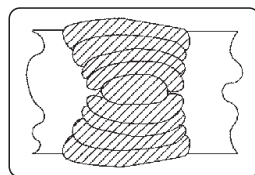

120 - 180 A

Hyvä yhteensulautuminen vaak- ja pystysuunnassa



150 - 200 A

Ei käytössä

24V - 28V
PUOLILYHYTKAARI
(SEMI SHORT-ARC)
(Siirtoalue)

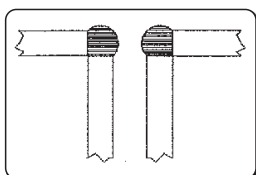

150 - 250 A

Kulmien automaattihitsaus

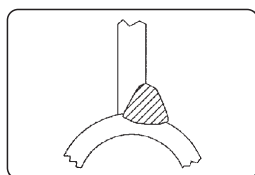

200 - 300 A

Automaattinen hitsaus korkeajännitteellä

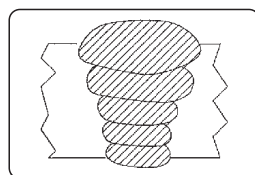

250 - 350 A

Automaattinen hitsaus Ylhäältä alas



300 - 400 A

Ei käytössä

30V - 45V
SPRAY - ARC

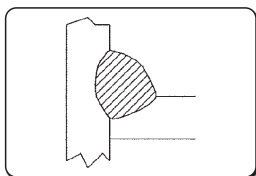

150 - 250 A

Alhainen läpäisevyys 200 A säätelyllä

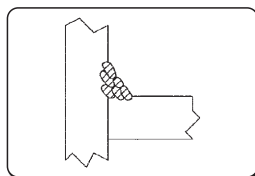

200 - 350 A

Automaattihitsaus moniohituksella

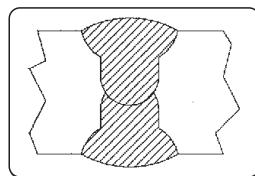

300 - 500 A

Hyvä läpäisevyys laskeutuessa

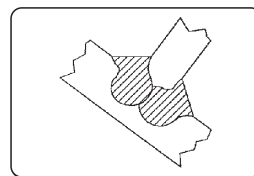

500 - 750 A

Hyvä läpäisevyys, korkea tallennus suurille kiiloille

Unalloyed steel

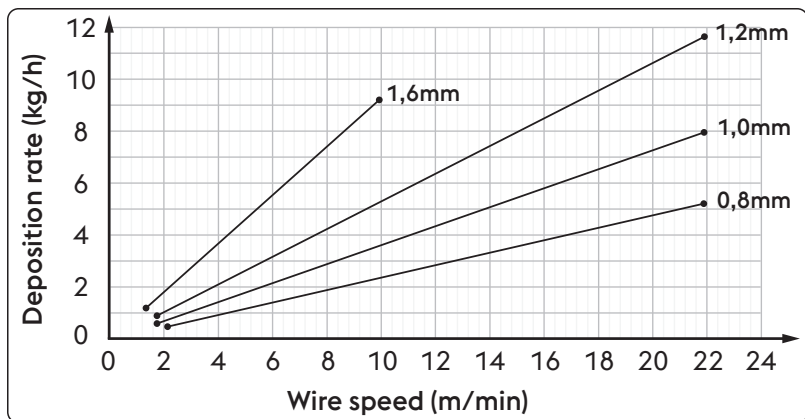

Ø	Wire speed	Deposition rate
0,8 mm	2,0 m/min	0,5 kg/h
	22,0 m/min	5,3 kg/h
1,0 mm	1,6 m/min	0,6 kg/h
	22,0 m/min	8,1 kg/h
1,2 mm	1,6 m/min	0,9 kg/h
	22,0 m/min	11,7 kg/h
1,6 mm	1,2 m/min	1,1 kg/h
	10,0 m/min	9,4 kg/h

High alloyed steel

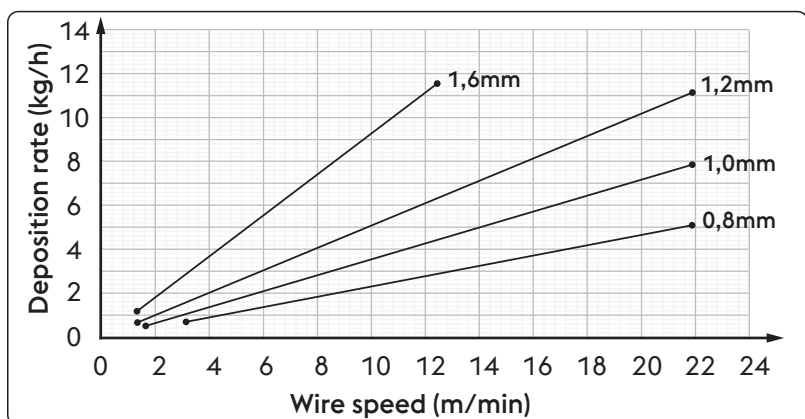

Ø	Wire speed	Deposition rate
0,8 mm	2,0 m/min	0,5 kg/h
	22,0 m/min	5,3 kg/h
1,0 mm	1,6 m/min	0,6 kg/h
	22,0 m/min	8,1 kg/h
1,2 mm	1,6 m/min	0,9 kg/h
	22,0 m/min	11,7 kg/h
1,6 mm	1,2 m/min	1,1 kg/h
	10,0 m/min	9,4 kg/h

Aluminum alloy

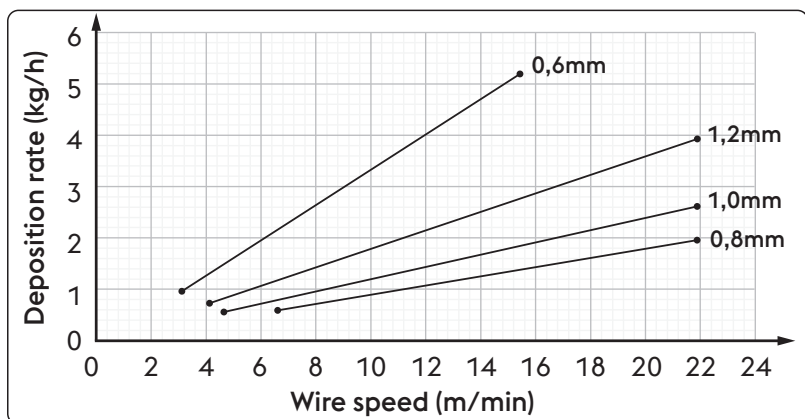

Ø	Wire speed	Deposition rate
0,8 mm	6,5 m/min	0,6 kg/h
	22,0 m/min	2,0 kg/h
1,0 mm	4,5 m/min	0,5 kg/h
	22,0 m/min	2,6 kg/h
1,2 mm	4,0 m/min	0,7 kg/h
	22,0 m/min	4,0 kg/h
1,6 mm	3,0 m/min	0,9 kg/h
	15,5 m/min	5,2 kg/h

Käytettävät kaasut

MIG-MAG -hitsauksen ominaispiirteet syntyvät käytettävästä kaasusta. Ei käytössä MIG-hitsauksessa (Metal Inert Gas) ja käytössä MAG-hitsauksessa (Metal Active Gas).

- Hiilidioksidi (CO₂)

Käytettäessä hiilidioksidia suojakaasuna saadaan korkeat läpäisyt suurella etenemisnopeudella ja hyvät mekaaniset ominaisuudet halvoilla käyttökustannuksilla. Tämän kaasun käyttö tosin aiheuttaa ongelmia liitosten lopullisessa kemiallisessa palamisessa, johtuen helposti hapettuvien osien hävikistä, ja samalla tapahtuu hiilen rikastumista hitsisulaan. Hitsaus hiilidioksidilla aiheuttaa myös muita ongelmia, kuten liikaa roiskeita ja hiilidioksidin aiheuttamaa huokoisuutta.

- Argon

Tätä kaasua käytetään ainoastaan hitsattaessa kevyitä seoksia, kun taas hitsattaessa krominikkelisiä hapettumattomia teräksiä suositellaan lisättäväksi happea ja hiilidioksidia 2%. Tämä edesauttaa kaaren tasaisuutta ja antaa paremman muodon hitsaukselle.

- Helium

Tätä kaasua käytetään vaihtoehtona argonille ja mahdollistaa paremman läpäisevyyden (suurille kiiloille) ja nopeamman etenemisen.

- Argon-helium seos

Saadaan vakaampi kaari puhtaaseen heliumiin verrattuna, parempi läpäisevyys ja nopeus argoniin verrattuna.

- Argon- CO₂ ja Argon- CO₂ -Happi seos

Näitä seoksia käytetään hitsattaessa rautapitoisia tuotteita LYHYTKAARIHITSAUKSELLA (SHORT-ARC), koska ne parantavat hitsattavan materiaalin termisyyttä.

Tämä ei poissulje käyttöä KUUMAKAARIHITSAUKSESSA (SPRAY-ARC).

Tavallisesti seos sisältää hiili-dioksidia 8% - 20% ja happea O₂ noin 5%.



Katso lisätietoja järjestelmän käyttöohjekirjasta.

Unalloyed steel / High alloyed steel		Aluminum alloy	
Hitsausvirta	Kaasun virtaus	Hitsausvirta	Kaasun virtaus
3-50 A	10-12 l/min	3-50 A	10-12 l/min
30-100 A	10-14 l/min	30-100 A	10-15 l/min
75-150 A	12-16 l/min	75-150 A	12-18 l/min
150-250 A	14-18 l/min	150-250 A	14-22 l/min
250-400 A	16-20 l/min	250-400 A	16-25 l/min
400-500 A	18-22 l/min	400-500 A	18-30 l/min

11. TEKNISET OMINAISUUDET

Langansyöttölaitteen ominaisuudet WF NX 430 SteelDrive		U.M.
Hammaspyörämootorin tyyppi	SL4R-4T	
Hammaspyörämootorin teho	120	W
N° pyöräisellä	4	
Langan halkaisija / Vakiorulla	1.0-1.2	mm
Käytettävien lankojen halkaisija / Vetävät rullat	Syöttönopeuden säädön 0.8-1.6 alumiinilanka 1.2-2.4 täytelanka	mm/materiaali
Kaasun tyhjennyspainike	kyllä	
Langan etenemispainike	kyllä	
Langan paluusyöttöpainike	no	
Langan nopeus	25 Ø 0.8 - 1.0	m/min
Synergiat	kyllä	
Ulkoiset laitteet	kyllä (valinnainen)	
Polttimen vuorovaihe painike (Push-Pull)	kyllä (valinnainen)	
Kelan halkaisija	200/300	mm
Etupyörien halkaisija	63/125 (optional)	mm
Takapyörien halkaisija	63/125 (optional)	mm
Sähköiset ominaisuudet WF NX 430 SteelDrive		U.M.
Syöttöjännite U1	48	Vdc
Tiedonsiirtoväylä	DIGITAALINEN	
Maksimi ottovirta I1max	4.5	A
Käyttökerroin WF NX 430 SteelDrive		U.M.
Käyttökerroin (40°C)		
(X=50%)	500	A
(X=60%)	470	A
(X=100%)	420	A
Käyttökerroin (25°C)		
(X=80%)	500	A
(X=100%)	470	A
Fyysiset ominaisuudet WF NX 430 SteelDrive		U.M.
IP-luokitus	IP23S	
Mitat (lxdxh)	640x250x460	mm
Paino	19.0	Kg
Standardit	EN IEC 60974-5:2019 EN 60974-10/A1:2015	

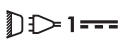
12. ARVOKILPI

 VOESTALPINE BÖHLER WELDING SELCO S.R.L. Via Palladio,19 - ONARA (PADOVA) - ITALY			
WF NX 430		N°	
EN 60974-5:2019 IEC 60974-10/A1:2015 Class A			
	X (40°C)	60%	100%
	I₂	500A	400A
	U₁ 48V	I_{1max} 4.5A	
IP 23 S		UK CA CE EAC	
MADE IN ITALY 			

13. KILVEN SISÄLTÖ

1		2	
3		4	
5			
	6	6A	6B
	7	7A	7B
8	9	10	
11		UK CA CE EAC	
MADE IN ITALY 			

- 1 Kaupallinen merkki
- 2 Valmistajan nimi ja osoite
- 3 Laitteen malli
- 4 Sarjanro
- XXXXXXXXXXXXXX Valmistusvuosi
- 5 Viittaus rakennestandardeihin
- 6 Katkohitsausjakson symboli
- 7 Nimellishitsausvirran symboli
- 6A Katkohitsausjakson arvot
- 6B Katkohitsausjakson arvot
- 7A Nimellishitsausvirran arvot
- 7B Nimellishitsausvirran arvot
- 8 Virtalähteen symboli
- 9 Nimellisliitännätännite
- 10 Suurin nimellisliitännätännite
- 11 Suojausluokka

CE EU-vaatimustenmukaisuusvakuutus
 EAC EAC-vaatimustenmukaisuusvakuutus
 UKCA UKCA-vaatimustenmukaisuusvakuutus

ΔΗΛΩΣΗ ΣΥΜΜΟΡΦΩΣΗΣ ΕΥ

Ο οικοδόμος

voestalpine Böhler Welding Selco S.r.l. - Via Palladio, 19 - 35019 Onara di Tombolo (PD) - ITALY
Tel. +39 049 9413/111 - Fax +39 049 9413/311 - www.voestalpine.com/welding

δηλώνει με αποκλειστική ευθύνη ότι το ακόλουθο προϊόν:

WF NX 430 STEELDRIVE

71.01.083

είναι κατασκευασμένη σε συμμόρφωση με τις Ευρωπαϊκές Οδηγίες:

2014/35/EU LOW VOLTAGE DIRECTIVE

2014/30/EU EMC DIRECTIVE

2011/65/EU RoHS DIRECTIVE

και ότι έχουν εφαρμοστεί τα ακόλουθα εναρμονισμένα πρότυπα:

EN IEC 60974-5:2019

WIRE FEEDERS

EN 60974-10/A1:2015

ELECTROMAGNETIC COMPATIBILITY REQUIREMENTS

Η τεκμηρίωση που πιστοποιεί τη συμμόρφωση με τις οδηγίες θα παραμείνει διαθέσιμη για επιθεωρήσεις στον προαναφερόμενο κατασκευαστή.

Τυχόν επεμβάσεις ή τροποποιήσεις που θα γίνουν χωρίς την εξουσιοδότηση της **voestalpine Böhler Welding Selco S.r.l.**, θα προκαλέσουν την παύση ισχύος της παραπάνω δήλωσης.

Onara di Tombolo, 03/07/2023

voestalpine Böhler Welding Selco s.r.l.

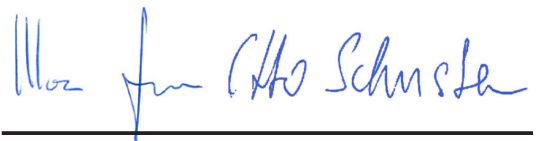

Mirco Frasson

Otto Schuster

Managing Directors

ΠΕΡΙΕΧΟΜΕΝΑ

1. ΠΡΟΕΙΔΟΠΟΙΗΣΕΙΣ	423
1.1 Περιβάλλον χρήσης	423
1.2 Ατομική προστασία και ασφάλεια τρίτων	423
1.3 Προστασία από καπνούς και αέρια	424
1.4 Πρόληψη πυρκαγιάς/έκρηξης	424
1.5 Προληπτικά μέτρα για τη χρήση φιαλών αερίου	425
1.6 Προστασία από ηλεκτροπληξία	425
1.7 Ηλεκτρομαγνητικά πεδία και παρεμβολές	425
1.8 Βαθμός προστασίας IP	426
1.9 Διάθεση.....	426
2. ΕΓΚΑΤΑΣΤΑΣΗ	426
2.1 Τρόπος ανύψωσης, μεταφοράς και εκφόρτωσης	427
2.2 Τοποθέτηση της διάταξης	427
2.3 Σύνδεση.....	427
2.4 Θέση σε λειτουργία.....	427
3. ΠΑΡΟΥΣΙΑΣΗ ΤΗΣ ΔΙΑΤΑΞΗΣ	429
3.1 Πίσω πάνελ	429
3.2 Πίνακας υποδοχών	429
3.3 Μπροστινός πίνακας ελέγχου.....	430
4. ΧΡΗΣΗ ΤΟΥ ΕΞΟΠΛΙΣΜΟΥ	431
4.1 Σελίδα εκκίνησης	431
4.2 Σελίδα τεστ	431
4.3 Αρχική σελίδα	431
5. SETUP	435
5.1 Set up και τη ρύθμιση των παραμέτρων.....	435
5.2 Ειδικές διαδικασίες χρήσης των παραμέτρων	444
6. ΑΞΕΣΟΥΡΑ	447
7. ΣΥΝΤΗΡΗΣΗ	448
7.1 Περιοδικοί έλεγχοι.....	448
7.2 Ευθύνη	448
8. ΚΩΔΙΚΟΙ ΣΥΝΑΓΕΡΜΩΝ (ΑΛΑΡΜ)	448
9. ΔΙΑΓΝΩΣΗ ΠΡΟΒΛΗΜΑΤΩΝ ΚΑΙ ΛΥΣΕΙΣ	450
10. ΟΔΗΓΙΕΣ ΧΡΗΣΗΣ	452
10.1 Συγκολλησης με συνεχές συρμα (mig/mag)	452
11. ΤΕΧΝΙΚΑ ΧΑΡΑΚΤΗΡΙΣΤΙΚΑ	457
12. ΠΙΝΑΚΙΔΑ ΧΑΡΑΚΤΗΡΙΣΤΙΚΩΝ	458
13. ΣΗΜΑΣΙΑ ΠΙΝΑΚΙΔΑΣ ΧΑΡ ΑΚΤΗΡΙΟΤΙΚΩΝ	458
14. ΔΙΑΓΡΑΜΜΑ	459
15. ΣΥΝΔΕΤΗΡΕΣ	460
16. ΚΑΤΑΛΟΓΟΣ	461
17. ΕΓΚΑΤΑΣΤΑΣΗ ΚΙΤ/ ΑΞΕΣΟΥΡΑ	464

ΣΥΜΒΟΛΑ



Άμεσοι κίνδυνοι που προκαλούν σοβαρούς τραυματισμούς ή επικίνδυνες ενέργειες που μπορούν να προκαλέσουν σοβαρούς τραυματισμούς.



Ενέργειες που μπορούν να προκαλέσουν μη σοβαρούς τραυματισμούς ή βλάβες σε αντικείμενα.



Οι σημειώσεις που ακολουθούν αυτό το σύμβολο, έχουν τεχνικό χαρακτήρα και διευκολύνουν τις ενέργειες.

1. ΠΡΟΕΙΔΟΠΟΙΗΣΕΙΣ



Πριν προβείτε σε οποιαδήποτε ενέργεια, πρέπει να διαβάσετε και να είστε βέβαιοι ότι κατανοήσατε το παρόν εγχειρίδιο. Μην κάνετε μετατροπές και ενέργειες συντήρησης που δεν περιγράφονται στο παρόν. Ο κατασκευαστής δε φέρει καμία ευθύνη για τυχόν βλάβες, σε πρόσωπα ή πράγματα, που οφείλονται σε πλημμελή ανάγνωση και/ή μη εφαρμογή των οδηγιών του παρόντος εγχειριδίου.

Διατηρείτε πάντα τις οδηγίες χρήσης στον τόπο χρήσης της συσκευής. Εκτός από τις οδηγίες χρήσης, τηρείτε τους γενικούς κανόνες και τους ισχύοντες τοπικούς κανονισμούς για την πρόληψη των ατυχημάτων και την προστασία του περιβάλλοντος.



Όλοι οι υπεύθυνοι για τη θέση σε λειτουργία, τη χρήση, τη συντήρηση και την επισκευή της συσκευής πρέπει:

- να διαθέτουν κατάλληλη εξειδίκευση
- να διαθέτουν τις αναγκαίες δεξιότητες για τις συγκολλήσεις
- να έχουν διαβάσει πλήρως και να τηρούν σχολαστικά τις παρούσες οδηγίες χρήσης

Για κάθε αμφιβολία ή πρόβλημα σχετικά με τη χρήση της διάταξης, έστω κι αν δεν περιγράφεται εδώ, συμβουλευτείτε κάποιον εξειδικευμένο τεχνικό.

1.1 Περιβάλλον χρήσης



Κάθε διάταξη πρέπει να χρησιμοποιείται αποκλειστικά και μόνο για τις λειτουργίες που σχεδιάστηκε, με τους τρόπους και το εύρος τιμών που αναγράφονται στην πινακίδα χαρακτηριστικών και/ή στο παρόν εγχειρίδιο, και σύμφωνα με τους εθνικούς και διεθνείς κανονισμούς ασφαλείας. Οποιαδήποτε άλλη χρήση, που διαφέρει από αυτές που δηλώνει ρητά ο Κατασκευαστής, θεωρείται απολύτως ανάρμοστη και επικίνδυνη, και, στην περίπτωση αυτή, ο Κατασκευαστής δε φέρει καμία ευθύνη.



Η συσκευή πρέπει να προορίζεται μόνο για επαγγελματική χρήση, σε βιομηχανικό περιβάλλον. Ο κατασκευαστής δε φέρει καμία ευθύνη για βλάβες που ενδεχομένως προκληθούν εξαιτίας της χρήσης της διάταξης μέσα σε κατοικίες.



Η διάταξη πρέπει να χρησιμοποιείται σε χώρους με θερμοκρασία μεταξύ -10°C και $+40^{\circ}\text{C}$ ($+14^{\circ}\text{F}$ και $+104^{\circ}\text{F}$).

Η διάταξη πρέπει να μεταφέρεται και να αποθηκεύεται σε χώρους με θερμοκρασία μεταξύ -25°C και $+55^{\circ}\text{C}$ (-13°F και 131°F).

Η διάταξη πρέπει να χρησιμοποιείται σε περιβάλλον χωρίς σκόνη, οξέα, αέρια ή άλλες διαβρωτικές ουσίες.

Η διάταξη πρέπει να χρησιμοποιείται σε περιβάλλον με σχετική υγρασία μικρότερη του 50%, στους 40°C ($40,00^{\circ}\text{C}$).

Η διάταξη πρέπει να χρησιμοποιείται σε περιβάλλον με σχετική υγρασία μικρότερη του 90%, στους 20°C (68°F).

Το μέγιστο επιτρεπόμενο υψόμετρο για τη χρήση της διάταξης είναι 2000 μ. (6500 πόδια).



Μη χρησιμοποιείτε αυτή τη συσκευή για να ξεπαγώνετε σωληνώσεις.

Μη χρησιμοποιείτε τη συσκευή για φόρτιση μπαταριών ή/και συσσωρευτών.

Μη χρησιμοποιείτε τη συσκευή για την εκκίνηση κινητήρων.

1.2 Ατομική προστασία και ασφάλεια τρίτων



Η διαδικασία συγκόλλησης αποτελεί πηγή βλαβερών ακτινοβολιών, θορύβου, θερμότητας και εκπομπής αερίων. Τοποθετήστε διαχωριστικό πυρίμαχο τοίχωμα, για να προστατευτεί η ζώνη συγκόλλησης από ακτίνες, σπινθήρες και πυρακτωμένα κομμάτια σκουριάς. Κάντε συστάσεις στους παρόντες να μην κοιτάζουν τη συγκόλληση και να προστατεύονται από τις ακτίνες του τόξου ή το πυρακτωμένο μέταλλο.



Φοράτε κατάλληλο ρουχισμό, που να προστατεύει το δέρμα από την ακτινοβολία του τόξου, τους σπινθήρες και/ή το πυρακτωμένο μέταλλο. Τα ρούχα που φοράτε πρέπει να καλύπτουν όλο το σώμα και πρέπει να είναι:

- Ακέραια και σε καλή κατάσταση
- Πυρίμαχα
- Μονωτικά και στεγνά
- Εφαρμοστά στο σώμα και χωρίς ρεβέρ



Φοράτε πάντοτε υποδήματα εγκεκριμένα σύμφωνα με τα σχετικά πρότυπα, ανθεκτικά και ικανά να εξασφαλίσουν τη μόνωση από το νερό.

Φοράτε πάντοτε γάντια, εγκεκριμένα με βάση τα σχετικά πρότυπα, που να εξασφαλίζουν την ηλεκτρική και θερμική μόνωση.



Για την προστασία των ματιών, χρησιμοποιείτε μάσκες με πλευρική προστασία για το πρόσωπο και κατάλληλο βαθμό προστασίας (Β.Π. 10 ή ανώτερος).



Φοράτε πάντα προστατευτικά γυαλιά με πλευρικά καλύμματα, ειδικά κατά τις ενέργειες χειροκίνητης ή μηχανικής απομάκρυνσης της σκουριάς συγκόλλησης (κοπή).



Μη φοράτε φακούς επαφής!



Φοράτε ωτοασπίδες, σε περίπτωση που η διαδικασία συγκόλλησης παρουσιάζει επικίνδυνη στάθμη θορύβου. Αν η στάθμη θορύβου υπερβαίνει τα όρια του νόμου, οριοθετήστε τη ζώνη εργασίας και βεβαιωθείτε ότι οι παρόντες προστατεύονται με ωτοασπίδες ή ωτοβύσματα.



Διατηρείτε πάντα τα πλευρικά τοιχώματα κλειστά, κατά τη διάρκεια των εργασιών συγκόλλησης. Απαγορεύεται οποιαδήποτε μετατροπή της διάταξης. Αποφύγετε την επαφή χεριών, μαλλιών, ρούχων, εργαλείων... και κινούμενων εξαρτημάτων, όπως: ανεμιστήρες, γρανάζια, ράουλα και άξονες, καρούλια σύρματος. Μη επεμβαίνετε στους οδοντωτούς τροχούς (γρανάζια), όταν λειτουργεί ο τροφοδότης σύρματος. Η απενεργοποίηση των προστατευτικών διατάξεων στους τροφοδότες σύρματος δημιουργεί μία εξαιρετικά επικίνδυνη κατάσταση και απαλλάσσει τον κατασκευαστή από κάθε ευθύνη για τυχόν βλάβες και ατυχήματα.



Κρατάτε το κεφάλι μακριά από την τσιμπίδα MIG/MAG, κατά τη διάρκεια της φόρτωσης και προώθησης του σύρματος. Το σύρμα, κατά την έξοδο, μπορεί να προκαλέσει σοβαρούς τραυματισμούς στα χέρια, στο πρόσωπο και στα μάτια.



Αποφύγετε την επαφή με κομμάτια, αμέσως μετά τη συγκόλληση. Η υψηλή θερμοκρασία μπορεί να προκαλέσει σοβαρά εγκαύματα. Οι παραπάνω προφυλάξεις πρέπει να τηρούνται και στις εργασίες μετά τη συγκόλληση, γιατί μπορεί να αποκολλούνται κομμάτια σκουριάς από τα επεξεργασμένα κομμάτια που ψύχονται.



Πριν κάνετε κάποια ενέργεια πάνω στην τσιμπίδα ή προβείτε στη συντήρησή της, βεβαιωθείτε ότι έχει κρυώσει.



Πριν αποσυνδέσετε τους σωλήνες προσαγωγής και επιστροφής του ψυκτικού υγρού, βεβαιωθείτε ότι η μονάδα ψύξης είναι σβηστή. Το θερμό υγρό που βγαίνει μπορεί να προκαλέσει σοβαρά εγκαύματα.



Προμηθευτείτε τα απαραίτητα μέσα πρώτων βοηθειών. Μην παραμελείτε τυχόν εγκαύματα ή τραυματισμούς.



Πριν εγκαταλείψετε τη θέση εργασίας, πάρτε τα απαραίτητα μέτρα ασφαλείας, για να αποφευχθούν ακούσιες βλάβες και ατυχήματα.

1.3 Προστασία από καπνούς και αέρια



Οι καπνοί, τα αέρια και οι σκόνης που παράγονται από τη διαδικασία συγκόλλησης, μπορεί να αποδειχθούν επιβλαβή για την υγεία. Υπό ορισμένες συνθήκες, οι καπνοί που παράγονται από τη συγκόλληση μπορεί να προκαλέσουν καρκίνο ή, στις έγκυες γυναίκες, βλάβες στο έμβρυο.

- Κρατάτε το κεφάλι μακριά από τα αέρια και τους καπνούς της συγκόλλησης.
- Η ζώνη εργασίας πρέπει να διαθέτει κατάλληλο σύστημα φυσικού ή βεβιασμένου αερισμού.
- Σε περίπτωση ανεπαρκούς αερισμού, χρησιμοποιήστε μάσκες με αναπνευστήρες.
- Σε περίπτωση συγκολλήσεων σε χώρους μικρών διαστάσεων, σας συνιστούμε την επίβλεψη του συγκολλητή από κάποιο συνάδελφο, που βρίσκεται έξω από το συγκεκριμένο χώρο.
- Μη χρησιμοποιείτε οξυγόνο για τον εξαερισμό.
- Για να ελέγχετε την αποτελεσματικότητα της αναρρόφησης, συγκρίνετε κατά περιόδους την ποσότητα των εκπομπών επιβλαβών αερίων με τις επιτρεπτές τιμές που αναγράφονται στους κανονισμούς ασφαλείας.
- Η ποσότητα και η επικινδυνότητα των παραγόμενων καπνών εξαρτάται από το βασικό υλικό που χρησιμοποιείται, από το υλικό συγκόλλησης και από ενδεχόμενες ουσίες που χρησιμοποιούνται για καθαρισμό και απολίπανση των κομματιών που συγκολλούνται. Ακολουθήστε πιστά τις οδηγίες του κατασκευαστή και των σχετικών τεχνικών δελτίων.
- Μην κάνετε συγκολλήσεις (κοπές) κοντά σε χώρους απολίπανσης ή βαφής.
- Τοποθετείτε τις φιάλες αερίου σε ανοικτούς χώρους ή σε χώρους με καλή κυκλοφορία του αέρα.

1.4 Πρόληψη πυρκαγιάς/έκρηξης



Η διαδικασία συγκόλλησης μπορεί να αποτελέσει αιτία πυρκαγιάς και/ή έκρηξης.

- Απομακρύνετε, από τη ζώνη εργασίας και τη γύρω περιοχή, τα εύφλεκτα ή καύσιμα υλικά και αντικείμενα.
- Τα εύφλεκτα υλικά πρέπει να βρίσκονται σε απόσταση τουλάχιστον 11 μέτρων (35 ποδιών) από το χώρο συγκόλλησης ή πρέπει να προστατεύονται κατάλληλα.
- Οι σπινθήρες και τα πυρακτωμένα σωματίδια που εκσφενδονίζονται μπορούν να φτάσουν εύκολα στις γύρω περιοχές ακόμη και από πολύ μικρά ανοίγματα. Προσέξτε ιδιαίτερα την ασφάλεια πραγμάτων και ατόμων.
- Μην κάνετε συγκολλήσεις πάνω ή κοντά σε δοχεία που βρίσκονται υπό πίεση.
- Μην εκτελείτε εργασίες συγκόλλησης σε κλειστά δοχεία ή σωλήνες. Επίσης, ιδιαίτερη προσοχή απαιτείται κατά τη συγκόλληση σωλήνων ή δοχείων, έστω και αν αυτά είναι ανοιχτά, άδεια και προσεκτικά καθαρισμένα. Τυχόν υπολείμματα αερίων, καυσίμων, λαδιού ή παρόμοιων ουσιών, μπορεί να προκαλέσουν εκρήξεις.
- Μην κάνετε συγκολλήσεις σε ατμόσφαιρα που περιέχει σκόνη, εκρηκτικά αέρια ή αναθυμιάσεις.

- Μετά τη συγκόλληση, βεβαιωθείτε ότι το ηλεκτρικό κύκλωμα δεν ακουμπά κατά λάθος σε επιφάνειες συνδεδεμένες με το κύκλωμα της γείωσης.
- Κοντά στη ζώνη εργασίας πρέπει να υπάρχει εξοπλισμός ή σύστημα πυρασφαλείας.

1.5 Προληπτικά μέτρα για τη χρήση φιαλών αερίου



Οι φιάλες αδρανούς αερίου περιέχουν αέριο υπό πίεση και μπορούν να εκραγούν, σε περίπτωση που δεν τηρούνται οι ελάχιστες συνθήκες ασφαλείας μεταφοράς, αποθήκευσης και χρήσης.

- Οι φιάλες πρέπει να είναι σταθερά στερεωμένες, σε κατακόρυφη θέση, πάνω σε τοίχους ή με άλλα κατάλληλα μέσα, για να αποφεύγονται πτώσεις ή τυχαία χτυπήματα.
- Βιδώνετε το κάλυμμα προστασίας της βαλβίδας κατά τη μεταφορά και την τοποθέτηση, καθώς και κάθε φορά που ολοκληρώνονται οι διαδικασίες συγκόλλησης.
- Αποφύγετε την έκθεση των φιαλών στην άμεση ηλιακή ακτινοβολία και σε απότομες μεταβολές θερμοκρασίας. Μην εκτίθετε τις φιάλες σε πολύ χαμηλές ή πολύ υψηλές θερμοκρασίες.
- Αποφύγετε την επαφή των φιαλών με ελεύθερες φλόγες, ηλεκτρικά τόξα, τσιμπίδες συγκόλλησης ή ηλεκτροδίων και πυρακτωμένων θραυσμάτων που παράγονται από τη συγκόλληση.
- Κρατήστε τις φιάλες μακριά από τα κυκλώματα συγκόλλησης και από ηλεκτρικά κυκλώματα γενικότερα.
- Κρατάτε το κεφάλι μακριά από το σημείο εξόδου του αερίου, όταν ανοίγετε τη βαλβίδα της φιάλης.
- Κλείνετε πάντα τη βαλβίδα της φιάλης, αφού ολοκληρώσετε τις εργασίες συγκόλλησης.
- Μην εκτελείτε ποτέ συγκολλήσεις σε φιάλες αερίου που βρίσκονται υπό πίεση.
- Μην συνδέετε ποτέ τη φιάλη πεπιεσμένου αέρα απευθείας στο μειωτήρα πίεσης του μηχανήματος! Η πίεση μπορεί να υπερβεί την ισχύ του μειωτήρα πίεσης και, κατά συνέπεια, να προκαλέσει έκρηξη!

1.6 Προστασία από ηλεκτροπληξία



Η ηλεκτροπληξία μπορεί να προκαλέσει θάνατο.

- Αποφύγετε την επαφή με τα σημεία που βρίσκονται συνήθως υπό τάση, στο εσωτερικό ή στο εξωτερικό της διάταξης συγκόλλησης, όταν η διάταξη έχει ρεύμα (οι τσιμπίδες, τα σώματα γείωσης, τα καλώδια γείωσης, τα ηλεκτρόδια, τα καλώδια, τα ράουλα και τα καρούλια συνδέονται με το ηλεκτρικό κύκλωμα συγκόλλησης).
- Εξασφαλίστε την ηλεκτρική μόνωση της εγκατάστασης και του χειριστή, χρησιμοποιώντας στεγνές επιφάνειες και βάσεις, με επαρκή μόνωση από το δυναμικό του εδάφους και της γείωσης.
- Βεβαιωθείτε ότι η εγκατάσταση συνδέεται σωστά, σε κάποια πρίζα και σε δίκτυο που διαθέτουν αγωγό γείωσης.
- Ο χειριστής δεν πρέπει να αγγίζει ταυτόχρονα δύο τσιμπίδες ηλεκτροδίων.
- Διακόψτε αμέσως τη συγκόλληση, εάν νιώσετε ότι σας διαπερνά ηλεκτρικό ρεύμα.

1.7 Ηλεκτρομαγνητικά πεδία και παρεμβολές



Η διέλευση του ρεύματος από τα εσωτερικά και εξωτερικά καλώδια της διάταξης, δημιουργεί ηλεκτρομαγνητικό πεδίο κοντά στα καλώδια συγκόλλησης και στην ίδια τη διάταξη.

- Τα ηλεκτρομαγνητικά πεδία μπορεί να έχουν (άγνωστες μέχρι σήμερα) επιπτώσεις στην υγεία, μετά από παρατεταμένη έκθεση.
- Τα ηλεκτρικά πεδία μπορούν να προκαλέσουν παρεμβολές σε άλλες ηλεκτρικές συσκευές, όπως στους βηματοδότες ή στα ακουστικά βαρηκοΐας.



Τα άτομα με ζωτικές ηλεκτρονικές συσκευές (βηματοδότες), πρέπει να συμβουλευθούν έναν ιατρό πριν πλησιάσουν κοντά σε εργασίες συγκόλλησης τόξου.

1.7.1 Ταξινόμηση ΗΜΣ σύμφωνα με το πρότυπο: EN 60974-10/A1:2015.



Η συσκευή κατηγορίας Β είναι κατασκευασμένη σε συμμόρφωση με τις απαιτήσεις συμβατότητας σε βιομηχανικούς χώρους ή κατοικίες, συμπεριλαμβανομένων των κατοικημένων περιοχών όπου η ηλεκτρική ενέργεια παρέχεται από κάποιο δημόσιο σύστημα χαμηλής τάσης.



Η συσκευή κατηγορίας Α δεν προορίζεται για χρήση σε κατοικημένες περιοχές όπου η ηλεκτρική ενέργεια παρέχεται από κάποιο δημόσιο σύστημα χαμηλής τάσης. Θα ήταν δυνητικά δύσκολο να εξασφαλιστεί η ηλεκτρομαγνητική συμβατότητα των συσκευών κατηγορίας Α σε αυτές τις περιοχές, εξαιτίας των παρεμβολών που εκπέμπονται και προσάγονται.

Δείτε το κεφάλαιο για περισσότερες πληροφορίες: ΠΙΝΑΚΪΔΑ ΧΑΡΑΚΤΗΡΙΣΤΙΚΩΝ ή ΤΕΧΝΙΚΑ ΧΑΡΑΚΤΗΡΙΣΤΙΚΑ.

1.7.2 Εγκατάσταση, χρήση και αξιολόγηση του χώρου

Η συσκευή αυτή κατασκευάζεται σύμφωνα με τις οδηγίες του εναρμονισμένου προτύπου EN 60974-10/A1:2015 και κατατάσσεται στην “ΚΑΤΗΓΟΡΙΑ Α”. Η συσκευή πρέπει να προορίζεται μόνο για επαγγελματική χρήση, σε βιομηχανικό περιβάλλον. Ο κατασκευαστής δε φέρει καμία ευθύνη για βλάβες που ενδεχομένως προκληθούν εξαιτίας της χρήσης της διάταξης μέσα σε κατοικίες.



Ο χρήστης πρέπει να έχει εμπειρία στον τομέα αυτό και θεωρείται υπεύθυνος για την εγκατάσταση και τη χρήση της συσκευής, σύμφωνα με τις οδηγίες του κατασκευαστή. Αν παρατηρηθούν ηλεκτρομαγνητικές παρεμβολές, ο χρήστης πρέπει να λύσει το πρόβλημα με την τεχνική υποστήριξη του κατασκευαστή.



Σε όλες τις περιπτώσεις, οι ηλεκτρομαγνητικές παρεμβολές πρέπει να ελαττωθούν έως το βαθμό στον οποίο που δεν προκαλούν ενόχληση.



Πριν την εγκατάσταση της συσκευής, ο χρήστης πρέπει να εκτιμήσει τα πιθανά ηλεκτρομαγνητικά προβλήματα που θα μπορούσαν να παρουσιαστούν στη γύρω ζώνη και ιδιαίτερα στην υγεία των παρόντων. Για παράδειγμα: άτομα με βηματοδότη (pace-maker) και ακουστικά βαρηκοΐας.

1.7.3 Προληπτικά μέτρα σχετικά με τα καλώδια

Για την ελαχιστοποίηση των επιπτώσεων από τα ηλεκτρομαγνητικά πεδία, ακολουθείτε τους εξής κανόνες:

- Τυλίγετε και στερεώνετε μαζί, όπου αυτό είναι δυνατό, το καλώδιο γείωσης με το καλώδιο ισχύος.
- Αποφεύγετε το τύλιγμα των καλωδίων γύρω από το σώμα.
- Μη στέκεστε μεταξύ καλωδίου γείωσης και καλωδίου ισχύος (τα δύο καλώδια πρέπει να βρίσκονται από την ίδια πλευρά).
- Τα καλώδια πρέπει να έχουν το μικρότερο δυνατό μήκος, να τοποθετούνται κοντά μεταξύ τους και να μετακινούνται πάνω ή κοντά στην επιφάνεια του δαπέδου.
- Τοποθετείτε την διάταξη σε κάποια απόσταση από το σημείο συγκόλλησης.
- Τα καλώδια πρέπει να είναι τοποθετημένα μακριά από ενδεχόμενα άλλα καλώδια.

1.7.4 Ισοδυναμική σύνδεση (γείωση)

Πρέπει να εκτιμήσετε αν είναι απαραίτητη η γείωση όλων των μεταλλικών εξαρτημάτων της εγκατάστασης συγκόλλησης και της γύρω περιοχής. Τηρήστε τους τοπικούς τεχνικούς κανονισμούς περί ισοδυναμικής σύνδεσης (γείωσης).

1.7.5 γείωση του κατεργαζόμενου κομματιού

Όπου το υπό επεξεργασία κομμάτι δεν είναι γειωμένο, για λόγους ηλεκτρικής ασφαλείας ή εξαιτίας των διαστάσεων και της θέσης του, η σύνδεση γείωσης μεταξύ τεμαχίου και εδάφους μπορεί να μειώσει τις εκπομπές. Απαιτείται προσοχή, ώστε η γείωση του κατεργαζόμενου κομματιού να μην αυξάνει τον κίνδυνο ατυχήματος για το χειριστή ή να προκαλεί βλάβες σε άλλες ηλεκτρικές συσκευές. Τηρήστε τους τοπικούς τεχνικούς κανονισμούς περί ισοδυναμικής σύνδεσης (γείωσης).

1.7.6 Θωράκιση

Η επιλεκτική θωράκιση άλλων καλωδίων και συσκευών στη γύρω περιοχή μπορεί να μειώσει τα προβλήματα παρεμβολών. Σε ειδικές εφαρμογές, θα μπορούσε να ληφθεί υπόψη η θωράκιση όλης της διάταξης συγκόλλησης.

1.8 Βαθμός προστασίας IP



IP23S

- Περίβλημα που αποτρέπει την τυχαία πρόσβαση σε επικίνδυνα μέρη κάποιου δάχτυλου ή κάποιου ξένου σώματος με διάμετρο ίση ή μεγαλύτερη από 12,5 mm.
- Περίβλημα προστατευμένο από βροχή που πέφτει με γωνία 60°.
- Περίβλημα που αποτρέπει τις βλαβερές συνέπειες της εισόδου νερού, όταν τα κινούμενα μέρη της συσκευής είναι ακίνητα.

1.9 Διάθεση



Μην απορρίπτετε την ηλεκτρική συσκευή με τα κοινά απόβλητα!

Σύμφωνα με την Ευρωπαϊκή Οδηγία 2012/19/ΕΕ σχετικά με τα απόβλητα ηλεκτρικού και ηλεκτρονικού εξοπλισμού, και για την εφαρμογή της βάσει της εθνικής νομοθεσίας, ο ηλεκτρικός εξοπλισμός που φτάνει στο τέλος του κύκλου ζωής του, πρέπει να συλλέγεται χωριστά και να παραδίδεται σε κέντρο ανάκτησης και διάθεσης. Ο ιδιοκτήτης της συσκευής οφείλει να αναζητήσει τα εξουσιοδοτημένα κέντρα συλλογής απευθυνόμενος στις τοπικές αρχές. Η εφαρμογή της Ευρωπαϊκής Οδηγίας θα επιτρέψει την καλύτερη προστασία του περιβάλλοντος και της υγείας του ανθρώπου.

» Για περισσότερες πληροφορίες, επισκεφθείτε την ιστοσελίδα.

2. ΕΓΚΑΤΑΣΤΑΣΗ



Η εγκατάσταση μπορεί να γίνει μόνο από έμπειρο προσωπικό, εξουσιοδοτημένο από τον κατασκευαστή.



Πριν την εγκατάσταση, βεβαιωθείτε ότι η γεννήτρια είναι αποσυνδεδεμένη από το ηλεκτρικό δίκτυο.

2.1 Τρόπος ανύψωσης, μεταφοράς και εκφόρτωσης

- Η διάταξη διαθέτει μια χειρολαβή, που επιτρέπει τη μετακίνησή της με το χέρι.
- Η διάταξη δεν διαθέτει ειδικά εξαρτήματα για την ανύψωση.
- Χρησιμοποιήστε ένα κλαρκ εκτελώντας προσεκτικά τη μετακίνηση, έτσι ώστε να αποφευχθεί η ανατροπή της γεννήτριας.



Μην υποτιμάτε το βάρος της διάταξης (βλ. τεχνικά χαρακτηριστικά).

Κατά την ανύψωση, κανένα άτομο δεν πρέπει να βρίσκεται κάτω από το φορτίο.

Αποφύγετε την πτώση της διάταξης και μην την αποθέτετε με δύναμη στο δάπεδο.

2.2 Τοποθέτηση της διάταξης



Τηρήστε τους εξής κανόνες:

- Εύκολη πρόσβαση στα όργανα ελέγχου και τις συνδέσεις.
- Μην τοποθετείτε τον εξοπλισμό σε στενούς χώρους.
- Μην τοποθετείτε ποτέ τη διάταξη πάνω σε μια επιφάνεια με κλίση μεγαλύτερη από 10° ως προς το οριζόντιο επίπεδο.
- Τοποθετήστε τη διάταξη σε χώρο στεγνό, καθαρό και με επαρκή εξαερισμό.
- Προστατέψτε τη διάταξη από τη βροχή και τον ήλιο.

2.3 Σύνδεση





Οι κινητές μονάδες τροφοδοτούνται αποκλειστικά με χαμηλή τάση.

2.4 θέση σε λειτουργία

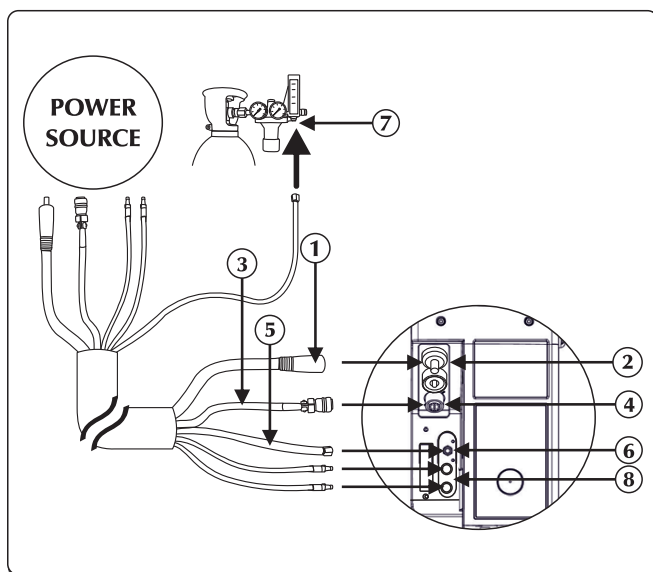
2.4.1 Σύνδεση για συγκόλληση MIG/MAG



- ① Καλωδίου ισχύος
- ② θετική υποδοχή ισχύος (+)
- ③ Καλώδιο σήματος
- ④ είσοδος καλωδίου σήματος
- ⑤ Σωλήνας αερίου
- ⑥ Αερίου ρακόρ/σύνδεσμο
- ⑦ Ρακόρ τροφοδοσίας αερίου
- ⑧ Ρακόρ ψυκτικού υγρού

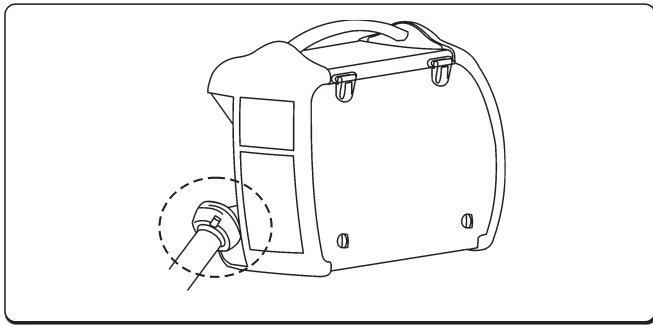

- ▶ Συνδέστε το καλώδιο ισχύος της δέσμης καλωδίων στην ειδική υποδοχή. Βάλτε το βύσμα και γυρίστε δεξιόστροφα, έως ότου ασφαλίσουν τα δύο μέρη.
- ▶ Συνδέστε το καλώδιο σήματος, της δέσμης καλωδίων, στο ειδικό βύσμα σύνδεσης. Βάλτε το βύσμα και γυρίστε το δακτύλιο δεξιόστροφα, έως ότου ασφαλίσουν τα δύο μέρη.
- ▶ Συνδέστε το σωλήνα αερίου της δέσμης καλωδίων στο μειωτήρα πίεσης της φιάλης ή στο ρακόρ τροφοδοσίας αερίου. Ρυθμίστε τη ροή αερίου από 10 έως 30 λίτρα/λεπτό.
- ▶ Συνδέστε το σωλήνα προσαγωγής ψυκτικού υγρού, της δέσμης καλωδίων (μπλε χρώματος), στο ειδικό ρακόρ/σύνδεσμο (μπλε χρώματος - σύμβολο ).
- ▶ Συνδέστε το σωλήνα επιστροφής ψυκτικού υγρού, της δέσμης καλωδίων (κόκκινου χρώματος), στο ειδικό ρακόρ/σύνδεσμο (κόκκινου χρώματος - σύμβολο ).
- ▶ Συνδέστε το καλώδιο σήματος CAN-BUS, που είναι για τη διαχείριση των εξωτερικών διατάξεων (όπως RC, RI, κτλ.), στην ειδική υποδοχή.

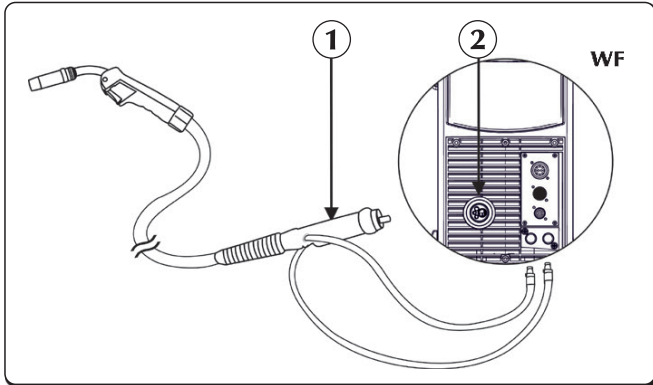

βλ. παράγραφο «Εγκατάσταση αξεσουάρ».



- ① υποδοχή σύνδεσης τσιμπίδας
- ② Συνδετήρας

- ▶ Συνδέστε το σωλήνα επιστροφής ψυκτικού υγρού της τσιμπίδας (κόκκινου χρώματος), στο ειδικό ρακόρ/σύνδεσμο (κόκκινου χρώματος - σύμβολο )
- ▶ Συνδέστε το σωλήνα προσαγωγής ψυκτικού υγρού της τσιμπίδας (μπλε χρώματος), στο ειδικό ρακόρ/σύνδεσμο (μπλε χρώματος - σύμβολο )
- ▶ Συνδέστε την τσιμπίδα MIG/MAG στην υποδοχή, προσέχοντας ιδιαίτερα, ώστε να βιδώσετε εντελώς το δακτύλιο στερέωσης.

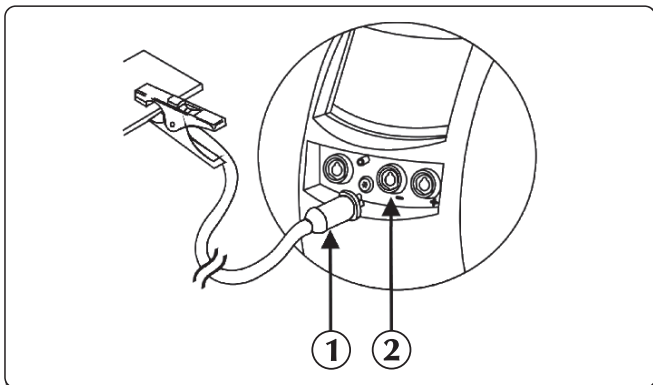

- ① Βύσμα τσιμπίδας γείωσης
- ② αρνητική υποδοχή ισχύος (-)

- ▶ Συνδέστε το βύσμα του καλωδίου της τσιμπίδας σώματος στην αρνητική υποδοχή (-) της γεννήτριας. Βάλτε το βύσμα και γυρίστε δεξιόστροφα, έως ότου ασφαλισουν τα δύο μέρη.

Χώρος κινητήρα

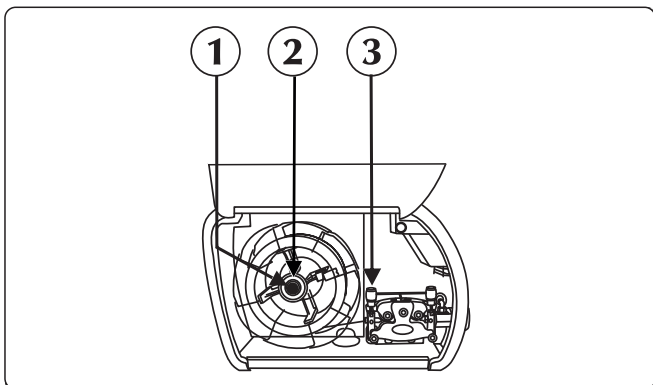

- ① Δακτύλιο
- ② βίδα φρένου
- ③ στήριγμα προώθησης του ηλεκτρομει-ωτήρα

- ▶ Ανοίξτε το δεξιό πλευρικό τοίχωμα.
- ▶ Βεβαιωθείτε ότι ο λαιμός του ράουλιου είναι κατάλληλος για τη διάμετρο του σύρματος που θέλετε να χρησιμοποιήσετε.

- ▶ Ξεβιδώστε το δακτύλιο, από τη βάση του καρουλιού, και τοποθετήστε το καρούλι.
- ▶ Βάλτε τον πείρο του άξονα μέσα στην υποδοχή του, τοποθετήστε το καρούλι, τοποθετήστε ξανά το δακτύλιο και ρυθμίστε τη βίδα φρένου.
- ▶ Ξεμπλοκάρετε το στήριγμα προώθησης του ηλεκτρομειωτήρα. Περάστε την άκρη του σύρματος μέσα από στο δακτύλιο-οδηγό, συνεχίστε πάνω από το ραουλάκι και μετά στη υποδοχή της τσιμπίδας. Μπλοκάρετε στη θέση του το στήριγμα προώθησης, αφού βεβαιωθείτε ότι το σύρμα έχει μπει στο λαιμό των ράουλων.
- ▶ Πατήστε το πλήκτρο προώθησης του σύρματος, για να φορτώσετε το σύρμα στην τσιμπίδα.
- ▶ Ρυθμίστε τη ροή αερίου από 10 έως 30 λίτρα/λεπτό.

3. ΠΑΡΟΥΣΙΑΣΗ ΤΗΣ ΔΙΑΤΑΞΗΣ

3.1 Πίσω πάνελ

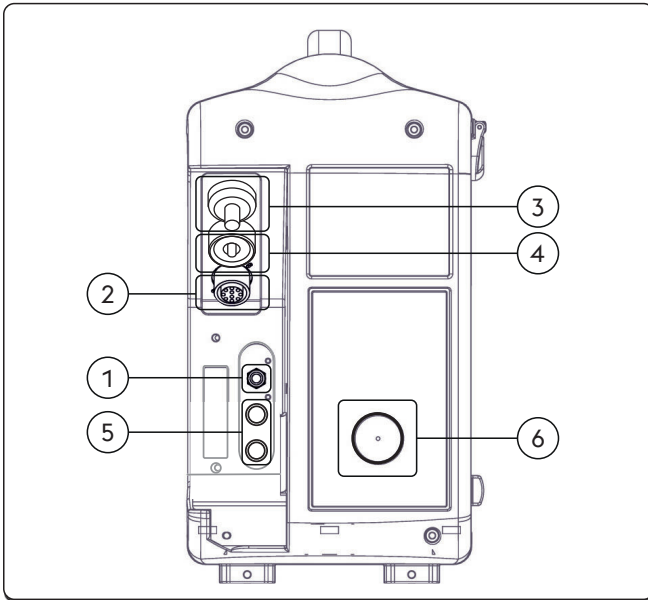

- ① Σύνδεση αερίου
- ② Είσοδος καλωδίου σήματος (CAN-BUS) (Δέσμη καλωδίων)
- ③ Είσοδος καλωδίου ισχύος (Δέσμη καλωδίων)
- ④ θετική υποδοχή ισχύος (+)
- ⑤ Είσοδος/έξοδος ψυκτικού υγρού
- ⑥ Είσοδος του σύρματος



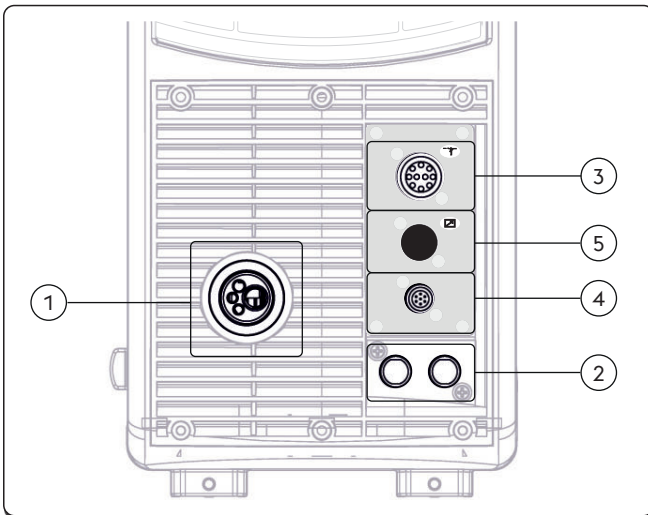



3.2 Πίνακας υποδοχών

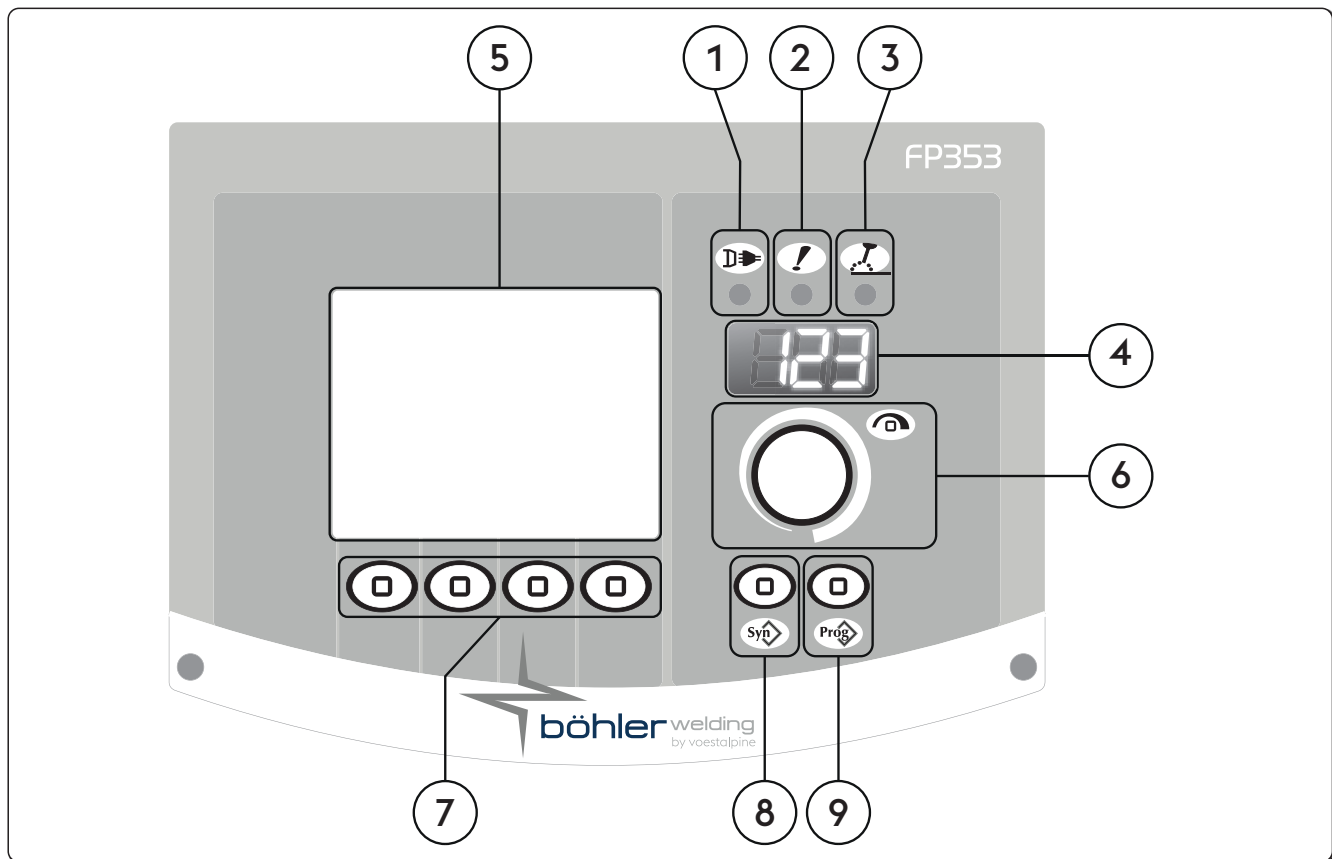

- ① υποδοχή σύνδεσης τσιμπίδας
Επιτρέπει τη σύνδεση της τσιμπίδας MIG/MAG.
- ② Ρακόρ ψυκτικού υγρού
- ③ είσοδος καλωδίου σήματος (Push-Pull)
- ④ Είσοδος καλωδίου σήματος (Τσιμπίδα)
Σύνδεση τσιμπίδας
- ⑤ Είσοδος καλωδίου σήματος (RC)

3.3 Μπροστινός πίνακας ελέγχου



- 1  **LED τροφοδοσίας**
Υποδεικνύει ότι η διάταξη είναι συνδεδεμένη με το δίκτυο και τροφοδοτείται κανονικά.
- 2  **LED γενικού συναγερμού**
Υποδεικνύει ότι επενέβη κάποια διάταξη ασφαλείας (π.χ., θερμικό).
- 3  **LED ενεργοποιημένης ισχύος**
Υποδεικνύει την παρουσία τάσης στις υποδοχές εξόδου της διάταξης.
- 4  **Οθόνη 7 τμημάτων**
Επιτρέπει την εμφάνιση των γενικών στοιχείων την μηχανής συγκόλλησης, κατά την εκκίνηση, τις ρυθμίσεις και τις καταγραφόμενες τιμές του ρεύματος και της τάσης, κατά τη συγκόλληση, καθώς και τους κωδικούς συναγερμού.
- 5  **Οθόνη (LCD)**
Επιτρέπει την εμφάνιση των γενικών στοιχείων την μηχανής συγκόλλησης, κατά την εκκίνηση, τις ρυθμίσεις και τις καταγραφόμενες τιμές του ρεύματος και της τάσης, κατά τη συγκόλληση, καθώς και τους κωδικούς συναγερμού. Επιτρέπει την άμεση εμφάνιση όλων των λειτουργιών.
- 6  **Κύριος διακόπτης ρύθμισης**
Επιτρέπει την είσοδο στο set up, την επιλογή και τη ρύθμιση των παραμέτρων συγκόλλησης.
- 7  **Πλήκτρα λειτουργίας**
Επιτρέπουν την επιλογή των διαφόρων λειτουργιών της διάταξης:
- Διαδικασία συγκόλλησης
- Τρόπος συγκόλλησης
- Παλμικότητα ρεύματος
- Γραφική απεικόνιση

8  **Πλήκτρο προγραμμάτων συγκόλλησης**

Επιτρέπει την επιλογή του επιθυμητού προγράμματος συγκόλλησης, μέσω της εισαγωγής μερικών απλών πληροφοριών:

- Τύπος σύρματος
- Τύπος αερίου
- Διάμετρος σύρματος

9  **Πλήκτρο job**

4. ΧΡΗΣΗ ΤΟΥ ΕΞΟΠΛΙΣΜΟΥ

4.1 Σελίδα εκκίνησης

Κατά την εκκίνηση, η εγκατάσταση εκτελεί μια σειρά ελέγχων που διασφαλίζουν τη σωστή λειτουργία της εγκατάστασης και όλων των συνδεδεμένων διατάξεων. Κατά το στάδιο αυτό πραγματοποιείται και το τεστ αερίου, για να διαπιστωθεί η σωστή σύνδεση του συστήματος τροφοδοσίας αερίου.

4.2 Σελίδα τεστ

Όταν το πλευρικό τοίχωμα (χώρος καρουλιού) είναι ανοιχτό, όλες οι ενέργειες συγκόλλησης απενεργοποιούνται. Στην οθόνη LCD εμφανίζεται η σελίδα των τεστ.

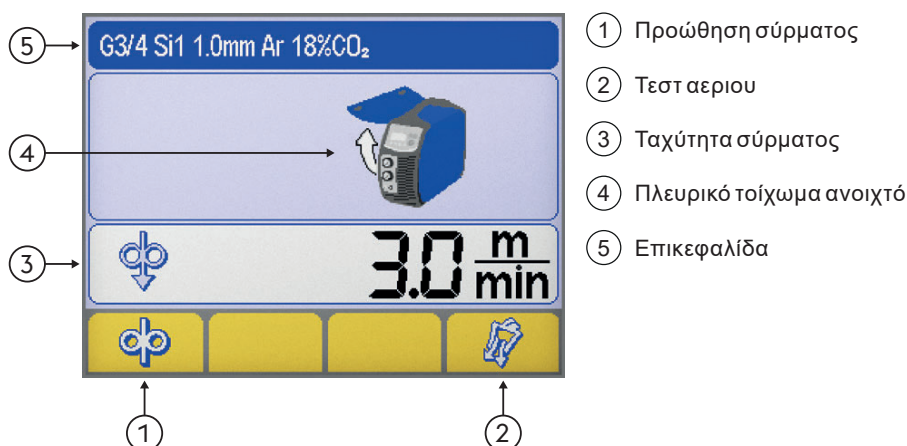

Προώθηση σύρματος

Επιτρέπει την χειροκίνητη προώθηση του σύρματος, χωρίς ροή αερίου και τάση στο σύρμα. Επιτρέπει την εισαγωγή του σύρματος μέσα στο περίβλημα της τσιμπίδας, κατά τα στάδια προετοιμασίας της συγκόλλησης.



Τεστ αερίου

Επιτρέπει την απομάκρυνση των ακαθαρσιών από το κύκλωμα του αερίου και την πραγματοποίηση, χωρίς ισχύ στην έξοδο, των απαραίτητων προκαταρκτικών ρυθμίσεων πίεσης και παροχής του αερίου.



Ταχύτητα σύρματος

Επιτρέπει τη ρύθμιση της ταχύτητας προώθησης του σύρματος (Κατά τη διάρκεια της φάσης φόρτωσης).

Ελάχιστη	Μέγιστη	Προκαθορισμ
0.5 m/min	22.0 m/min	3.0 m/min



Πλευρικό τοίχωμα ανοιχτό



Επικεφαλίδα

Εμφανίζει μερικές σημαντικές πληροφορίες που αφορούν τον επιλεγμένο τρόπο συγκόλλησης.

4.3 Αρχική σελίδα

Επιτρέπει τη διαχείριση της διάταξης και του τρόπου συγκόλλησης, με την εμφάνιση των βασικών ρυθμίσεων.

4.4 Κεντρική οθόνη διαδικασίας MIG/MAG

Βασική οθόνη

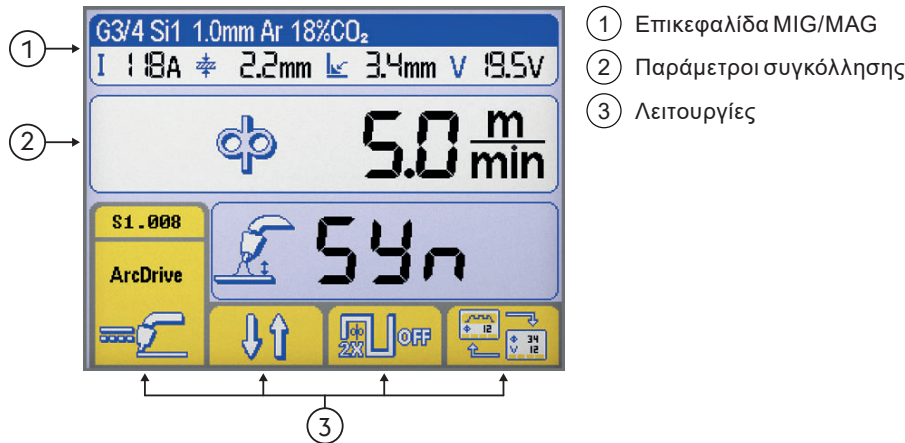

- ① Επικεφαλίδα MIG/MAG
- ② Παράμετροι συγκόλλησης
- ③ Λειτουργίες

Οθόνη γραφικών

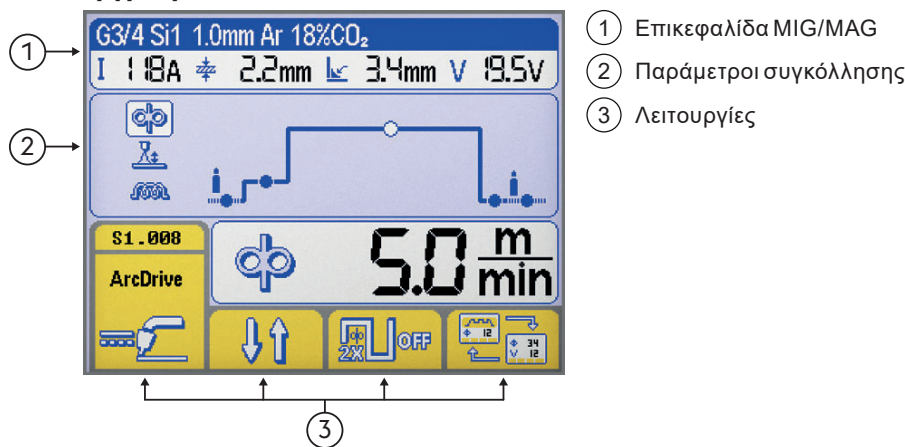

- ① Επικεφαλίδα MIG/MAG
- ② Παράμετροι συγκόλλησης
- ③ Λειτουργίες

Επικεφαλίδα MIG/MAG

Εμφανίζει μερικές σημαντικές πληροφορίες που αφορούν τον επιλεγμένο τρόπο συγκόλλησης.

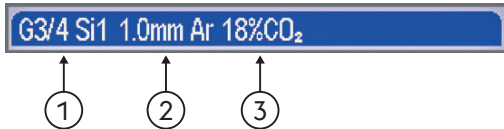

επιλεγμένη καμπύλη συνεργίας

- ① Τύπος υλικού συγκόλλησης (κόλληση)
- ② Διάμετρος σύρματος
- ③ Τύπος αερίου

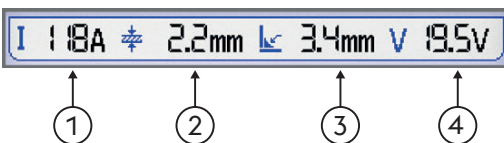

Παράμετροι συγκόλλησης

- ① Ρεύμα συγκόλλησης
- ② Πάχος κομματιού
- ③ Ραφή γωνίας "a"
- ④ Τάση συγκόλλησης

Παράμετροι συγκόλλησης (Βασική οθόνη)

► Επιλέξτε την παράμετρο που θέλετε, πατώντας το πλήκτρο encoder.

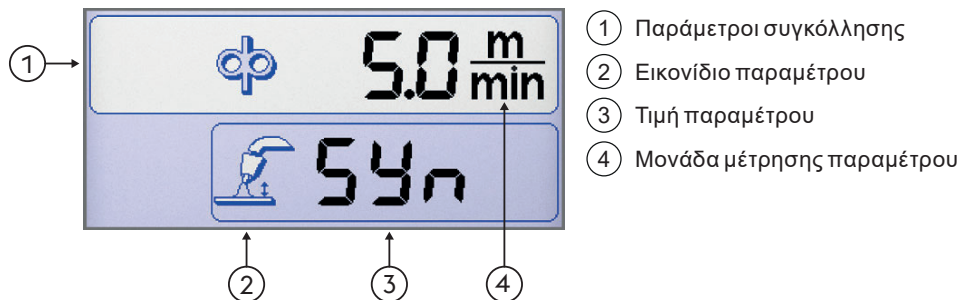

- ① Παράμετροι συγκόλλησης
- ② Εικονίδιο παραμέτρου
- ③ Τιμή παραμέτρου
- ④ Μονάδα μέτρησης παραμέτρου

Παράμετροι συγκόλλησης (Οθόνη γραφικών)

► Επιλέξτε την παράμετρο που θέλετε, πατώντας το πλήκτρο encoder.

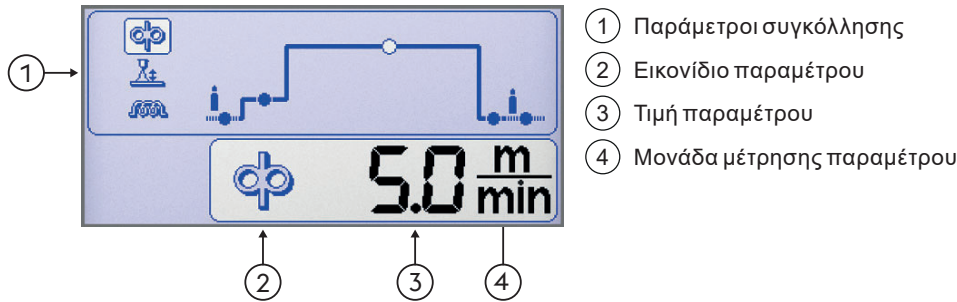

Λειτουργίες

Επιτρέπουν τη ρύθμιση της λειτουργικότητας των πιο σημαντικών τρόπων συγκόλλησης.

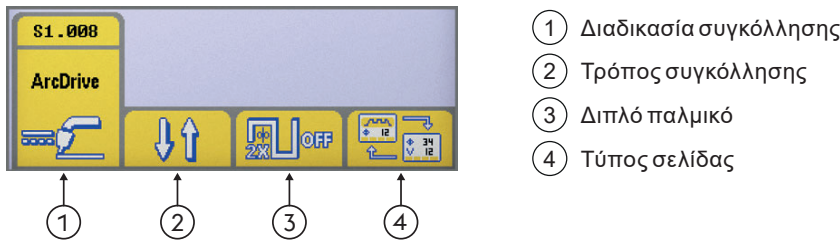

Τρόπος συγκόλλησης

Επιτρέπει την επιλογή του τρόπου συγκόλλησης



2 Χρόνοι

Σε δύο χρόνους, το πάτημα του πλήκτρου προκαλεί τη ροή του αερίου, ενεργοποιεί την τάση πάνω στο σύρμα και το προωθεί.

Μόλις αφεθεί, το αέριο, η τάση και η πρόωση του σύρματος απενεργοποιούνται.



4 Χρόνοι

Κατά τον τρόπο "4 Χρόνοι", το πρώτο πάτημα του πλήκτρου προκαλεί τη ροή του αερίου, πραγματοποιώντας ένα χειροκίνητο pre-gas. Μόλις αφεθεί, ενεργοποιείται η τάση στο σύρμα και η πρόωσή του. Με το επόμενο πάτημα του πλήκτρου, σταματάει το σύρμα και αρχίζει η τελική διαδικασία, που μηδενίζει το ρεύμα. Με την οριστική απελευθέρωση του πλήκτρου, σταματάει η ροή του αερίου.



Crater filler

Επιτρέπει την πραγματοποίηση μία συγκόλλησης με τρεις διαφορετικές κλίμακες ισχύος, η επιλογή και η διαχείριση των οποίων γίνεται απευθείας από το συγκολλητή, από το κουμπί της τσιμπίδας.

Με το πρώτο πάτημα του κουμπιού της τσιμπίδας αρχίζει η ροή αερίου, ενεργοποιείται η τάση πάνω στο σύρμα και αυτό προωθείται με την ταχύτητα που καθορίστηκε στην παράμετρο "αρχική αύξηση" (στο set up) και με τις σχετικές συνεργικές τιμές των παραμέτρων συγκόλλησης.

Μόλις αφεθεί το κουμπί της τσιμπίδας, η ταχύτητα σύρματος και οι σχετικές συνεργικές παράμετροι μεταβαίνουν αυτόματα στις αρχικές τιμές που καθορίστηκαν στον πίνακα ελέγχου.

Με το επόμενο πάτημα του κουμπιού της τσιμπίδας, η ταχύτητα σύρματος και οι σχετικές συνεργικές παράμετροι προσαρμόζονται στις τιμές που προκαθορίστηκαν στην παράμετρο (στο set up) crater filler.

Μόλις αφεθεί το κουμπί της τσιμπίδας, σταματάει η πρόωση του σύρματος και η παροχή ισχύος, και εκτελείται το burn back και το post gas.



Διπλό παλμικό



Διπλό παλμικό ΕΝΕΡΓΟ



Διπλό παλμικό ΜΗ ΕΝΕΡΓΟ

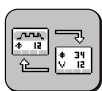

Τύπος σελίδας

Επιτρέπει την εναλλαγή μεταξύ των οθονών:



Βασική οθόνη



Οθόνη γραφικών

Σελίδα καμπυλών συνεργίας



Συνεργία

Επιτρέπει την επιλογή του επιθυμητού προγράμματος συγκόλλησης (συνεργία), μέσω της εισαγωγής μερικών απλών πληροφοριών

Επιλογή διαδικασίας συγκόλλησης

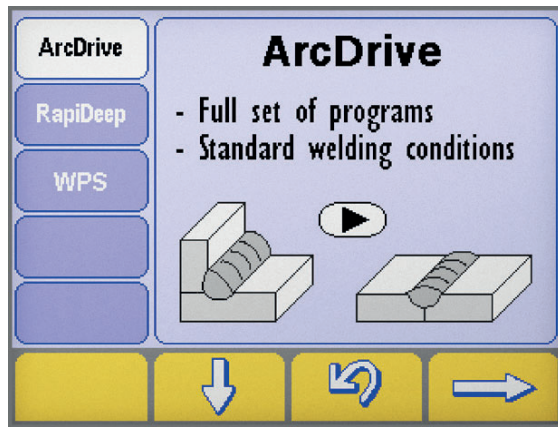

- ▶ Είσοδος στην οθόνη "συνεργική λειτουργία" πιέζοντας το πλήκτρο τουλάχιστον επί ένα δευτερόλεπτο.
- ▶ Επιλέξτε την επιθυμητή διαδικασία πιέζοντας τα πλήκτρα e .
- ▶ Πιέστε το κουμπί για μετάβαση στο επόμενο βήμα.



Οθόνη επιλογής συνδυασμού Τύπος υλικού/Τύπος αερίου

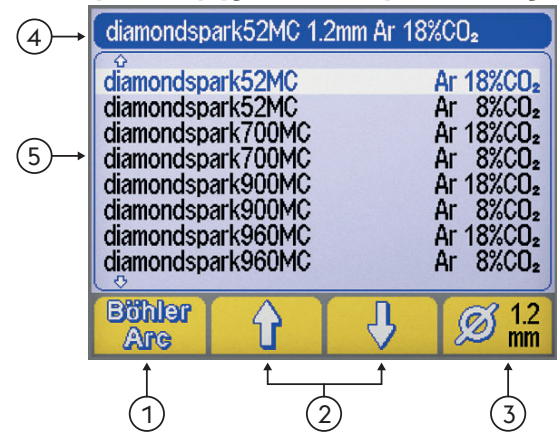

- 1 Προγράμματος συγκόλλησης (BöhlerArc/UniversalArc)
- 2 Επιλογή υλικού/αερίου
- 3 Διάμετρος σύρματος
- 4 Επικεφαλίδα
- 5 Προγράμματος συγκόλλησης

Προγράμματος συγκόλλησης
Επιτρέπει την επιλογή του προγράμματος συγκόλλησης

BöhlerArc UniversalArc

Επιλογή υλικού/αερίου
Πατήστε το τμήμα:

- Τύπος υλικού συγκόλλησης (κόλληση)
- Τύπος αερίου

Διάμετρος σύρματος
Επιτρέπει την επιλογή της διαμέτρου το χρησιμοποιούμενου σύρματος (mm).



- 1 Διάμετρος σύρματος

Επικεφαλίδα

Εμφανίζει μερικές σημαντικές πληροφορίες που αφορούν τον επιλεγμένο τρόπο συγκόλλησης.

NO PROGRAM

Σημαίνει ότι η καμπύλη συνεργίας που επιλέξατε δεν είναι διαθέσιμη ή δεν είναι συμβατή με τις άλλες ρυθμίσεις της διάταξης.

5. SETUP

5.1 Set up και τη ρύθμιση των παραμέτρων

Επιτρέπει τον προγραμματισμό και τη ρύθμιση μιας σειράς πρόσθετων παραμέτρων, για καλύτερη και ακριβέστερη διαχείριση της διάταξης συγκόλλησης.

Οι παράμετροι που εμφανίζονται στο set up είναι οργανωμένες ως προς την επιλεγμένη διαδικασία συγκόλλησης και διαθέτουν αριθμητική κωδικοποίηση.

Είσοδος στο set up





- ▶ Επιτυγχάνεται πατώντας για 5 δευτερόλεπτα το πλήκτρο encoder.
- ▶ Η είσοδος επιβεβαιώνεται από την ένδειξη 0 στην οθόνη.

Επιλογή και ρύθμιση της επιθυμητής παραμέτρου

- ▶ Γυρίστε το encoder, έως ότου εμφανιστεί ο αριθμητικός κωδικός της επιθυμητής παραμέτρου.
- ▶ Στο σημείο αυτό, με το πάτημα του πλήκτρο encoder, εμφανίζεται η προγραμματισμένη τιμή και η ρύθμιση της επιλεγμένης παραμέτρου.

Έξοδος από το set up

- ▶ Για να βγείτε από τις “ρυθμίσεις”, πατήστε πάλι το πλήκτρο encoder.
- ▶ Για έξοδο από το set up επιλέξτε την παράμετρο “0” (αποθήκευση και έξοδος) και πατήστε το πλήκτρο encoder.
- ▶ Επιβεβαιώστε την ενέργεια, πατώντας το πλήκτρο .
- ▶ Για αποθήκευση της τροποποίησης και έξοδο από το set up πιέστε το κουμπί: .

5.1.1 Κατάλογος παραμέτρων set up (MMA)

0
Αποθήκευση και έξοδος

Επιτρέπει την αποθήκευση των αλλαγών και την έξοδο από το set up.

1
Επαναφέρω

Επιτρέπει την επαναφορά όλων των παραμέτρων στις προκαθορισμένες τιμές (default).

3
Hot start

Επιτρέπει τη ρύθμιση της τιμής hot start σε MMA.

Επιτρέπει την επιλογή περισσότερο ή λιγότερο “θερμής” εκκίνησης στις φάσεις έναυσης του τόξου, διευκολύνοντας τη διαδικασία εκκίνησης (start).

Ηλεκτρόδιο βασικό

Ελάχιστη	Μέγιστη	Προκαθορισμ
0/μακριά από	500%	80%

Ηλεκτρόδιο κυτταρίνης

Ελάχιστη	Μέγιστη	Προκαθορισμ
0/μακριά από	500%	150%

Ηλεκτρόδιο CrNi

Ελάχιστη	Μέγιστη	Προκαθορισμ
0/μακριά από	500%	100%

Ηλεκτρόδιο αλουμινίου

Ελάχιστη	Μέγιστη	Προκαθορισμ
0/μακριά από	500%	120%

Ηλεκτρόδιο χυτοσιδήρου

Ελάχιστη	Μέγιστη	Προκαθορισμ
0/μακριά από	500%	100%

7

Ρεύμα συγκόλλησης

Επιτρέπει τη ρύθμιση του ρεύματος συγκόλλησης.



Ελάχιστη	Μέγιστη	Προκαθορισμ
3 A	I _{max}	100 A

8

Arc force

Επιτρέπει τη ρύθμιση της τιμής Arc force σε MMA.

Επιτρέπει την επιλογή περισσότερο ή λιγότερο έντονης δυναμικής απόκρισης στη συγκόλληση, διευκολύνοντας τις εργασίες του συγκολλητή.

Αυξήστε την τιμή του Arc force για να ελαττωθούν οι πιθανότητες να κολλήσει το ηλεκτρόδιο.



Ηλεκτρόδιο βασικό

Ελάχιστη	Μέγιστη	Προκαθορισμ
0/μακριά από	500%	30%

Ηλεκτρόδιο κυτταρίνης

Ελάχιστη	Μέγιστη	Προκαθορισμ
0/μακριά από	500%	350%

Ηλεκτρόδιο CrNi

Ελάχιστη	Μέγιστη	Προκαθορισμ
0/μακριά από	500%	30%

Ηλεκτρόδιο αλουμινίου

Ελάχιστη	Μέγιστη	Προκαθορισμ
0/μακριά από	500%	100%

Ηλεκτρόδιο χυτοσιδήρου

Ελάχιστη	Μέγιστη	Προκαθορισμ
0/μακριά από	500%	70%

204

Dynamic power control (DPC)

Επιτρέπει την επιλογή του επιθυμητού χαρακτηριστικού V/I.

I=C **Ρεύμα σταθερό**

Η αυξομείωση του ύψους του τόξου δεν επηρεάζει καθόλου το παρεχόμενο ρεύμα συγκόλλησης.

Συνιστάται για ηλεκτρόδιο: Βασικό, Ρουτίλιου, Ώξινη, Χάλυβα, Χυτοσιδήρου

1÷20 **Πτωτικό χαρακτηριστικό με ρύθμιση σταδιακής καθόδου (ράμπας)**

Η αύξηση του ύψους του τόξου προκαλεί τη μείωση του ρεύματος συγκόλλησης (και αντίστροφα), ανάλογα με την τιμή ρύθμισης, από 1 έως 20 Ampere, ανά Volt.

Συνιστάται για ηλεκτρόδιο: Κυτταρίνης, Αλουμινίου

P=C **Σταθερή ισχύς**

Η αύξηση του ύψους του τόξου προκαλεί την μείωση του ρεύματος συγκόλλησης (και αντίστροφα), με βάση τον κανόνα: V·I=K

Συνιστάται για ηλεκτρόδιο: Κυτταρίνης, Αλουμινίου



312

Τάση βεβιασμένου σβησίματος τόξου

Επιτρέπει τον προγραμματισμό της τιμής τάσης στην οποία σβήνει βεβιασμένα το ηλεκτρικό τόξο.

Επιτρέπει την καλύτερη διαχείριση των διαφόρων συνθηκών λειτουργίας που παρουσιάζονται.

Για παράδειγμα, κατά το ποντάρισμα (σημειακή συγκόλληση), η χαμηλή τάση βεβιασμένου σβησίματος τόξου επιτρέπει μικρότερη φλόγα κατά την απομάκρυνση του ηλεκτροδίου από το κομμάτι, μειώνοντας τα πισσιλίσματα, τα καψίματα και την οξειδωση του τεμαχίου.

Αντιθέτως, αν χρησιμοποιούνται ηλεκτρόδια που απαιτούν υψηλές τάσεις, σας συνιστούμε την επιλογή υψηλής τιμής, έτσι ώστε να αποφεύγεται το σβήσιμο του τόξου κατά τη συγκόλληση.



Μην επιλέγετε ποτέ μία τάση βεβιασμένου σβησίματος τόξου μεγαλύτερη από την τάση εν κενώ της γεννήτριας.

Ηλεκτρόδιο βασικό

Ελάχιστη	Μέγιστη	Προκαθορισμ
0/μακριά από	99.9 V	57.0 V

Ηλεκτρόδιο κυτταρίνης

Ελάχιστη	Μέγιστη	Προκαθορισμ
0/μακριά από	99.9 V	70.0 V

399

Ταχύτητα μετατόπισης

Επιτρέπει τη ρύθμιση της ταχύτητας εκτέλεσης της συγκόλλησης.

Default cm/min: ταχύτητα αναφοράς για τη χειροκίνητη συγκόλληση.

Syn: Sinergic αξία.



Ελάχιστη	Μέγιστη	Προκαθορισμ
1 cm/min	200 cm/min	15 cm/min

500 Προγραμματισμός μηχανήματος

Επιτρέπει την επιλογή της επιθυμητής γραφικής διεπαφής.
Επιτρέπει την πρόσβαση στα ανώτερα επίπεδα του set up.
βλ. παράγραφο "Εξατομίκευση οθόνης (Set up 500)"

Τιμή	Διεπαφή Χρήστη	Τιμή	Επιλεγμένο επίπεδο
XE	Τρόπος Easy	USER	Χρήστης
XA	Τρόπος Advanced	SERV	Service
XP	Τρόπος Professional	vaBW	vaBW

551 Lock/unlock

Επιτρέπει το μπλοκάρισμα των οργάνων ελέγχου και την εισαγωγή ενός κωδικού ασφαλείας.
βλ. παράγραφο "Lock/unlock (Set up 551)".

552 Τόνος βομβητή

Επιτρέπει την επιλογή τόνου του βομβητή.

Ελάχιστη	Μέγιστη	Προκαθορισμ
0/μακριά από	10	10

601 Βήμα ρύθμισης

Επιτρέπει τη ρύθμιση μιας παραμέτρου, με βήμα που μπορεί να επιλεγεί από το χρήστη.

Ελάχιστη	Μέγιστη	Προκαθορισμ
1	Imax	1

602 Εξωτερική παράμετρος CH1, CH2, CH3, CH4

Επιτρέπει τη διαχείριση της εξωτερικής παραμέτρου 1, 2, 3, 4 (ελάχιστη τιμή, μέγιστη τιμή, προκαθορισμένη τιμή, επιλεγμένη παράμετρος).

βλ. παράγραφο "διαχείριση εξωτερικών εντολών (Set up 602)".

705 Διακρίβωση αντίστασης κυκλώματος

Επιτρέπει τη βαθμονόμηση της εγκατάστασης.

βλ. παράγραφο "Διακρίβωση αντίστασης κυκλώματος (set up 705)".

751 Καταγραφή ρεύματος

Επιτρέπει την εμφάνιση της πραγματικής τιμής του ρεύματος συγκόλλησης.

752 Καταγραφή τάσης

Επιτρέπει την εμφάνιση της πραγματικής τιμής της τάσης συγκόλλησης.

768 Μέτρηση θερμικής παροχής HI

Επιτρέπει την εμφάνιση της τιμής μέτρησης της θερμικής παροχής σε συγκόλληση.

801 Όρια επιφυλακής

Επιτρέπει τον προγραμματισμό των ορίων προσοχής και των ορίων επιφυλακής.

Επιτρέπει τον έλεγχο του τρόπου συγκόλλησης, καθορίζοντας κάποια όρια προσοχής και όρια επιφυλακής, στις βασικές μετρήσιμες παραμέτρους.

Επιτρέπει τον επιμελή έλεγχο των διαφόρων φάσεων συγκόλλησης.

βλ. παράγραφο "Όρια επιφυλακής (Set up 801)".

5.1.2 Κατάλογος παραμέτρων στο set up (TIG)
0 Αποθήκευση και έξοδος

Επιτρέπει την αποθήκευση των αλλαγών και την έξοδο από το set up.

1 Επαναφέρω

Επιτρέπει την επαναφορά όλων των παραμέτρων στις προκαθορισμένες τιμές (default).



7 Ρεύμα συγκόλλησης

Επιτρέπει τη ρύθμιση του ρεύματος συγκόλλησης.



Ελάχιστη	Μέγιστη	Προκαθορισμ
3 A	I _{max}	100 A

399 Ταχύτητα μετατόπισης

Επιτρέπει τη ρύθμιση της ταχύτητας εκτέλεσης της συγκόλλησης.

Default cm/min: ταχύτητα αναφοράς για τη χειροκίνητη συγκόλληση.

Syn: Sinergic αξία.



Ελάχιστη	Μέγιστη	Προκαθορισμ
1 cm/min	200 cm/min	10 cm/min

500 Προγραμματισμός μηχανήματος

Επιτρέπει την επιλογή της επιθυμητής γραφικής διεπαφής.

Επιτρέπει την πρόσβαση στα ανώτερα επίπεδα του set up.

βλ. παράγραφο "Εξατομίκευση οθόνης (Set up 500)"



Τιμή	Διεπαφή Χρήστη
XE	Τρόπος Easy
XA	Τρόπος Advanced
XP	Τρόπος Professional

Τιμή	Επιλεγμένο επίπεδο
USER	Χρήστης
SERV	Service
vaBW	vaBW

551 Lock/unlock

Επιτρέπει το μπλοκάρισμα των οργάνων ελέγχου και την εισαγωγή ενός κωδικού ασφαλείας.

βλ. παράγραφο "Lock/unlock (Set up 551)".



552 Τόνος βομβητή

Επιτρέπει την επιλογή τόνου του βομβητή.



Ελάχιστη	Μέγιστη	Προκαθορισμ
0/μακριά από	10	10

601 Βήμα ρύθμισης

Επιτρέπει τη ρύθμιση μιας παραμέτρου, με βήμα που μπορεί να επιλεγεί από το χρήστη.



Ελάχιστη	Μέγιστη	Προκαθορισμ
1	I _{max}	1

602 Εξωτερική παράμετρος CH1, CH2, CH3, CH4

Επιτρέπει τη διαχείριση της εξωτερικής παραμέτρου 1, 2, 3, 4 (ελάχιστη τιμή, μέγιστη τιμή, προκαθορισμένη τιμή, επιλεγμένη παράμετρος).

βλ. παράγραφο "διαχείριση εξωτερικών εντολών (Set up 602)".



705 Διακρίβωση αντίστασης κυκλώματος

Επιτρέπει τη βαθμονόμηση της εγκατάστασης.

βλ. παράγραφο "Διακρίβωση αντίστασης κυκλώματος (set up 705)".



751 Καταγραφή ρεύματος

Επιτρέπει την εμφάνιση της πραγματικής τιμής του ρεύματος συγκόλλησης.



752 Καταγραφή τάσης

Επιτρέπει την εμφάνιση της πραγματικής τιμής της τάσης συγκόλλησης.



758
Ταχύτητα μετατόπισης ρομπότ

Επιτρέπει την εμφάνιση της ταχύτητας μετατόπισης του βραχίονα ενός ρομπότ ή κάποιας αυτόματης διάταξης.

768
Μέτρηση θερμικής παροχής HI

Επιτρέπει την εμφάνιση της τιμής μέτρησης της θερμικής παροχής σε συγκόλληση.

801
Όρια επιφυλακής

Επιτρέπει τον προγραμματισμό των ορίων προσοχής και των ορίων επιφυλακής.

Επιτρέπει τον έλεγχο του τρόπου συγκόλλησης, καθορίζοντας κάποια όρια προσοχής και όρια επιφυλακής, στις βασικές μετρήσιμες παραμέτρους.

Επιτρέπει τον επιμελή έλεγχο των διαφόρων φάσεων συγκόλλησης.

βλ. παράγραφο "Όρια επιφυλακής (Set up 801)".

5.1.3 Κατάλογος παραμέτρων στο set up (MIG/MAG)
0
Αποθήκευση και έξοδος

Επιτρέπει την αποθήκευση των αλλαγών και την έξοδο από το set up.

1
Επαναφέρω



Επιτρέπει την επαναφορά όλων των παραμέτρων στις προκαθορισμένες τιμές (default).

2
Προγραμμάτων συγκόλλησης

MIG/MAG πρότυπο:

 Επιτρέπει τη επιλογή της διαδικασίας χειροκίνητου MIG () ή συνεργικού MIG ()⁶, καθορίζοντας το προς συγκόλληση υλικό.

MIG Παλμικό:

 Επιτρέπει τη επιλογή της διαδικασίας συνεργικού MIG ()⁶, καθορίζοντας το προς συγκόλληση υλικό. Επιτρέπει τη επιλογή της διαδικασίας CC/CV.

3
Ταχύτητα σύρματος

Επιτρέπει τη ρύθμιση της ταχύτητας προώθησης του σύρματος.

Ελάχιστη	Μέγιστη	Προκαθορισμ
0.5 m/min	22.0 m/min	-

4
Ένταση (ρεύμα)

Επιτρέπει τη ρύθμιση του ρεύματος συγκόλλησης.

Ελάχιστη	Μέγιστη
3 A	I _{max}

5
Πάχος κομματιού

Επιτρέπει τον προγραμματισμό του πάχους του προς συγκόλληση κομματιού.

Επιτρέπει τη ρύθμιση της διάταξης ανάλογα με τα χαρακτηριστικά του προς συγκόλληση κομματιού.

6
Ραφή γωνίας "a"

Επιτρέπει τη ρύθμιση του βάθους της ραφής σε ένα γωνιακό σημείο σύνδεσης.

10
Pre gas

Επιτρέπει τον προγραμματισμό και τη ρύθμιση της ροής αερίου πριν την έναυση του τόξου.

Επιτρέπει την αποστολή αερίου στην τσιμπίδα και την προετοιμασία του περιβάλλοντος για τη συγκόλληση.

Ελάχιστη	Μέγιστη	Προκαθορισμ
0/μακριά από	99.9 s	0.1 s



11 Soft start

Επιτρέπει τη ρύθμιση της ταχύτητας προώθησης του σύρματος, κατά τα στάδια πριν την έναυση. Επιτρέπει την έναυση με μειωμένη ταχύτητα, έτσι ώστε να είναι ομαλότερη και με λιγότερα πιτσιλίσματα.

Ελάχιστη	Μέγιστη	Προκαθορισμ
10 %	100 %	50 %



12 Επιτάχυνση μοτέρ

Επιτρέπει τη σταδιακή μετάβαση της ταχύτητας σύρματος από την έναυση στη συγκόλληση.

Ελάχιστη	Μέγιστη	Προκαθορισμ
0/μακριά από	1.0 s	0/μακριά από

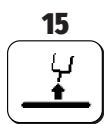

15 Burn back

Επιτρέπει τη ρύθμιση του χρόνου θέρμανσης του σύρματος, αποτρέποντας την προσκόλληση στο τέλος της συγκόλλησης.

Επιτρέπει τη ρύθμιση του μήκους του σύρματος που προεξέχει από την τσιμπίδα.

Ελάχιστη	Μέγιστη	Προκαθορισμ
-2.00	+2.00	0/syn



16 Post gas

Επιτρέπει τη ρύθμιση της ροής αερίου, στο τέλος της συγκόλλησης.

Ελάχιστη	Μέγιστη	Προκαθορισμ
0/μακριά από	99.9 s	2.0 s



19 Duty cycle (διπλό παλμικό)

Επιτρέπει τον καθορισμό της χρονικής διάρκειας διατήρησης του τελικού ρεύματος.

Ελάχιστη	Μέγιστη	Προκαθορισμ
10 %	90 %	50 %



20 Διπλό παλμικό

Επιτρέπει τη ρύθμιση του εύρους παλμού.

Ελάχιστη	Μέγιστη	Προκαθορισμ
0 %	100 %	±25 %

Ελάχιστη	Μέγιστη	Προκαθορισμ
0.5 m/min	22 m/min	2.5 m/min

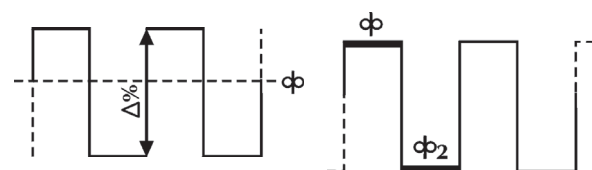

21 Συχνότητα παλμικού (διπλό παλμικό)

Επιτρέπει τη ρύθμιση της χρονικής περιόδου, δηλαδή, του κύκλου επανάληψης του παλμού.

Επιτρέπει τη ρύθμιση της συχνότητας του παλμού.

Ελάχιστη	Μέγιστη	Προκαθορισμ
0.1 Hz	5.0 Hz	2.0 Hz

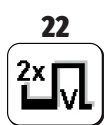

22 Δευτερεύουσα τάση (διπλό παλμικό)

Επιτρέπει τη ρύθμιση της τάσης του δευτερεύοντος επιπέδου παλμού.

Επιτρέπει τη επίτευξη μεγαλύτερης σταθερότητας τόξου κατά τις διάφορες φάσεις του παλμού.

Ελάχιστη	Μέγιστη	Προκαθορισμ
-5.0	+5.0	0/syn



23 Σταδιακές αυξομειώσεις παλμικού (διπλό παλμικό)

Επιτρέπει τον καθορισμό ενός χρόνου σταδιακής καθόδου κατά το στάδιο των παλμών.

Ελάχιστη	Μέγιστη	Προκαθορισμ
1 %	100 %	50 %



24 Bilevel (4T - crater filler)

Επιτρέπει τη ρύθμιση του ταχύτητα σύρματος, στη λειτουργία συγκόλλησης bilevel.

Αν ο συγκολλητής πατάει και αφήνει γρήγορα το κουμπί περνάει στο "Φ₂".

Πατώντας και αφήνοντας γρήγορα το κουμπί περνάει ξανά στο "Φ" κ.ο.κ.

Ελάχιστη	Μέγιστη	Προκαθορισμ
1 %	200 %	0/μακριά από

25 Αρχική αύξηση

Επιτρέπει τη ρύθμιση της τιμής ταχύτητας σύρματος, κατά την πρώτη φάση συγκόλλησης του "crater-filler".
Επιτρέπει την αύξηση της ενέργειας που παρέχεται στο κομμάτι, κατά τη φάση στην οποία το υλικό (που είναι ακόμη κρύο) απαιτεί περισσότερη θερμότητα, για να λιώσει με ομοιογενή τρόπο.

Ελάχιστη	Μέγιστη	Προκαθορισμ
20 %	200 %	120 %

26 Crater filler

Επιτρέπει τη ρύθμιση της τιμής ταχύτητας σύρματος, κατά τη φάση κλεισίματος της συγκόλλησης.
Επιτρέπει την μείωση της ενέργειας που παρέχεται στο κομμάτι, κατά τη φάση στην οποία το υλικό είναι ήδη πολύ ζεστό, για να αποφευχθεί ο κίνδυνος παραμόρφωσης.

Ελάχιστη	Μέγιστη	Προκαθορισμ
20 %	200 %	80 %

27 Χρονισμός αρχικής αύξησης



Επιτρέπει τον καθορισμό του χρόνου αρχικής αύξησης.
Επιτρέπει τον αυτοματισμό της λειτουργίας "crater filler".

Ελάχιστη	Μέγιστη	Προκαθορισμ
0.1 s	99.9 s	0/μακριά από

28 Χρονισμός του crater filler

Επιτρέπει τον καθορισμό του χρόνου του "crater filler".
Επιτρέπει τον αυτοματισμό της λειτουργίας "crater filler".

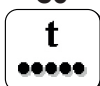
Ελάχιστη	Μέγιστη	Προκαθορισμ
0.1 s	99.9 s	0/μακριά από

30 Ποντάρισμα (σημειακή συγκόλληση)

Επιτρέπει την ενεργοποίηση της διαδικασίας "πονταρίσματος" (σημειακής συγκόλλησης) και την επιλογή του χρόνου συγκόλλησης.

Ελάχιστη	Μέγιστη	Προκαθορισμ
0.1 s	99.9 s	0/μακριά από

31 Σημείο παύσης

Επιτρέπει την ενεργοποίηση της διαδικασίας «σημείου παύσης» και την επιλογή του χρόνου παύσης μεταξύ δύο συγκολλήσεων.

Ελάχιστη	Μέγιστη	Προκαθορισμ
0.1 s	99.9 s	0/μακριά από

32 Δευτερεύουσα τάση (Bilevel MIG)

Επιτρέπει τη ρύθμιση της τάσης του δευτερεύοντος επιπέδου παλμού.
Επιτρέπει τη επίτευξη μεγαλύτερης σταθερότητας τόξου κατά τις διάφορες φάσεις του παλμού.

Ελάχιστη	Μέγιστη	Προκαθορισμ
-5.0	+5.0	0/syn

33 Δευτερεύουσα επαγωγή (Bilevel MIG)

Επιτρέπει τη ρύθμιση της επαγωγής του δευτερεύοντος επιπέδου παλμού.
Επιτρέπει την επίτευξη ενός πολύ ή λίγο γρήγορου τόξου, έτσι ώστε να αντισταθμίζει τις κινήσεις του συγκολλητή και της φυσιολογικής αστάθειας της συγκόλλησης.
Χαμηλή επαγωγή = αντιδραστικό τόξο (περισσότερα πιτσιλίσματα).
Υψηλή επαγωγή = λίγο αντιδραστικό τόξο (περιορισμένα πιτσιλίσματα).

Ελάχιστη	Μέγιστη	Προκαθορισμ
-30	+30	0/syn

34 Σταδιακή αρχική αύξηση

Επιτρέπει τη ρύθμιση της σταδιακής μετάβασης, από την αρχική αύξηση, στο ρεύμα συγκόλλησης.

Ελάχιστη	Μέγιστη	Προκαθορισμ
0 s	10 s	0/μακριά από

35 Σταδιακή μετάβαση crater filler



Επιτρέπει τη ρύθμιση της σταδιακής μετάβασης, από τη συγκόλληση, στο crater filler.

Ελάχιστη	Μέγιστη	Προκαθορισμ
0 s	10 s	0/μακριά από

202 Επαγωγή



Επιτρέπει την ηλεκτρονική ρύθμιση της επαγωγής σειράς του κυκλώματος συγκόλλησης.

Επιτρέπει την επίτευξη ενός πολύ ή λίγο γρήγορου τόξου, έτσι ώστε να αντισταθμίζει τις κινήσεις του συγκολλητή και της φυσιολογικής αστάθειας της συγκόλλησης.

Χαμηλή επαγωγή = αντιδραστικό τόξο (περισσότερα πιτσιλίσματα).

Υψηλή επαγωγή = λίγο αντιδραστικό τόξο (περιορισμένα πιτσιλίσματα).

Ελάχιστη	Μέγιστη	Προκαθορισμ
-30	+30	0/syn

331 Αντισταθμισμένη μέση τάση



Επιτρέπει τη ρύθμιση της τάσης συγκόλλησης.

398 Σταθερά αναφοράς ταχύτητας μετακίνησης



Σταθερά αναφοράς για όλες τις διαδικασίες συγκόλλησης

Τιμή ταχύτητας μετακίνησης της σιμπίδας που χρησιμοποιείται από το σύστημα για τους υπολογισμούς των παραμέτρων συγκόλλησης

399 Ταχύτητα μετατόπισης



Επιτρέπει τη ρύθμιση της ταχύτητας εκτέλεσης της συγκόλλησης.

Default cm/min: ταχύτητα αναφοράς για τη χειροκίνητη συγκόλληση.

Syn: Sinergic αξία.

Ελάχιστη	Μέγιστη	Προκαθορισμ
syn min	syn max	35 cm/min

500 Προγραμματισμός μηχανήματος



Επιτρέπει την επιλογή της επιθυμητής γραφικής διεπαφής.

Επιτρέπει την πρόσβαση στα ανώτερα επίπεδα του set up.

βλ. παράγραφο "Εξατομίκευση οθόνης (Set up 500)"

Τιμή	Διεπαφή Χρήστη
XE	Τρόπος Easy
XA	Τρόπος Advanced
XP	Τρόπος Professional

Τιμή	Επιλεγμένο επίπεδο
USER	Χρήστης
SERV	Service
vaBW	vaBW

551 Lock/unlock



Επιτρέπει το μπλοκάρισμα των οργάνων ελέγχου και την εισαγωγή ενός κωδικού ασφαλείας.

βλ. παράγραφο "Lock/unlock (Set up 551)".

552 Τόνος βομβητή



Επιτρέπει την επιλογή τόνου του βομβητή.

Ελάχιστη	Μέγιστη	Προκαθορισμ
0/μακριά από	10	10

601 Βήμα ρύθμισης



Επιτρέπει τη ρύθμιση μιας παραμέτρου, με βήμα που μπορεί να επιλεγεί από το χρήστη.

Η λειτουργία ελέγχεται από το κουμπί πάνω / κάτω του φακού.

Ελάχιστη	Μέγιστη	Προκαθορισμ
1	Imax	1

602 Εξωτερική παράμετρος CH1, CH2, CH3, CH4



Επιτρέπει τη διαχείριση της εξωτερικής παραμέτρου 1, 2, 3, 4 (ελάχιστη τιμή, μέγιστη τιμή, προκαθορισμένη τιμή, επιλεγμένη παράμετρος).

βλ. παράγραφο "διαχείριση εξωτερικών εντολών (Set up 602)".

606
Τσιμπίδα U/D

Επιτρέπει τη διαχείριση της εξωτερικής παραμέτρου (U/D).



Τιμή	Προκαθορισμ	Λειτουργία επανάκλησης
0/μακριά από	-	μακριά από
1/11	X	Ένταση (ρεύμα)
	-	Άνοιγμα προγραμμάτων

612
Ρύθμιση Τσιμπίδας DgMig

Επιτρέπει τη διαχείριση των καναλιών της ψηφιακής τσιμπίδας.



Τιμή	Προκαθορισμ	Λειτουργία επανάκλησης
0/μακριά από	-	μακριά από
1/11	-	Ένταση (ρεύμα)
2/ 	-	Άνοιγμα προγραμμάτων
3/CH3	-	CH3
4/CH4	-	CH4
5/STD	X	STD

653
Ταχύτητα σύρματος

Επιτρέπει τη ρύθμιση της ταχύτητας προώθησης του σύρματος (Κατά τη διάρκεια της φάσης φόρτωσης).



Ελάχιστη	Μέγιστη	Προκαθορισμ
0.5 m/min	22.0 m/min	3.0 m/min

705
Διακρίβωση αντίστασης κυκλώματος

Επιτρέπει τη βαθμονόμηση της εγκατάστασης.

βλ. παράγραφο "Διακρίβωση αντίστασης κυκλώματος (set up 705)".

751
Καταγραφή ρεύματος

Επιτρέπει την εμφάνιση της πραγματικής τιμής του ρεύματος συγκόλλησης.

752
Καταγραφή τάσης

Επιτρέπει την εμφάνιση της πραγματικής τιμής της τάσης συγκόλλησης.

755
Καταγραφή παροχής αερί

Επιτρέπει την εμφάνιση της πραγματικής τιμής της παροχής αερίου.

757
Ταχύτητα σύρματος

Καταγραφή encoder μοτέρ 1.

758
Ταχύτητα μετατόπισης ρομπότ

Επιτρέπει την εμφάνιση της ταχύτητας μετατόπισης του βραχίονα ενός ρομπότ ή κάποιας αυτόματης διάταξης.

760
Καταγραφή ρεύματος (μοτέρ 1)

Επιτρέπει την εμφάνιση της πραγματικής τιμής του ρεύματος (μοτέρ 1).



768

Μέτρηση θερμικής παροχής HI

Επιτρέπει την εμφάνιση της τιμής μέτρησης της θερμικής παροχής σε συγκόλληση.



770

Μέτρηση του ποσοστού εναπόθεσης

Επιτρέπει την εμφάνιση της μέτρησης του ποσοστού εναπόθεσης.



801

Όρια επιφυλακής

Επιτρέπει τον προγραμματισμό των ορίων προσοχής και των ορίων επιφυλακής.

Επιτρέπει τον έλεγχο του τρόπου συγκόλλησης, καθορίζοντας κάποια όρια προσοχής και όρια επιφυλακής, στις βασικές μετρήσιμες παραμέτρους.

Επιτρέπει τον επιμελή έλεγχο των διαφόρων φάσεων συγκόλλησης.

βλ. παράγραφο "Όρια επιφυλακής (Set up 801)".



5.2 Ειδικές διαδικασίες χρήσης των παραμέτρων

5.2.1 Εξατομίκευση οθόνης 7 τμημάτων

Επιτρέπει τη συνεχή εμφάνιση της τιμής μιας παραμέτρου στην οθόνη 7 τμημάτων.

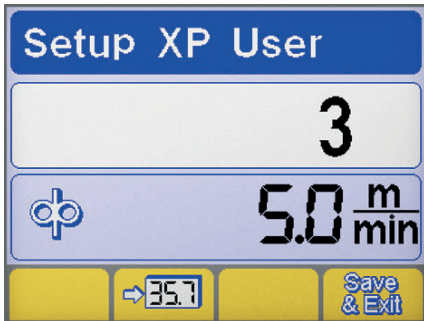

- ▶ Μπείτε στο set up, πατώντας το πλήκτρο encoder, για 5 τουλάχιστον δευτερόλεπτα.
- ▶ Επιλέξτε την παράμετρο που θέλετε.
- ▶ Αποθηκεύστε στη μνήμη την παράμετρο που έχει επιλεχτεί στην οθόνη 7 τμημάτων, πατώντας το πλήκτρο .
- ▶ Αποθηκεύστε στη μνήμη και βγείτε από την τρέχουσα σελίδα, πατώντας το πλήκτρο .

5.2.2 Εξατομίκευση οθόνης (Set up 500)

Επιτρέπει την εξατομίκευση των παραμέτρων της αρχικής σελίδας.

500

Προγραμματισμός μηχανήματος

Επιτρέπει την επιλογή της επιθυμητής γραφικής διεπαφής.





Τιμή	Διεπαφή Χρήστη
XE	Τρόπος Easy
XA	Τρόπος Advanced
XP	Τρόπος Professional

ΛΕΙΤΟΥΡΓΪΑ ΧΕ

MIG/MAG	
Παράμετροι συγκόλλησης	
Λειτουργίες	

ΛΕΙΤΟΥΡΓΪΑ ΧΑ

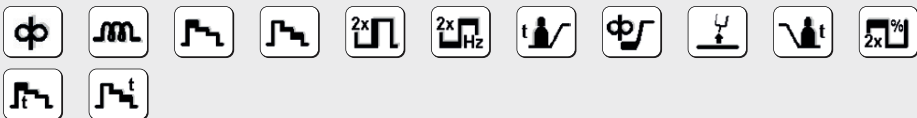
MIG/MAG	
Παράμετροι συγκόλλησης	
Λειτουργίες	

MIG/MAG	
Παράμετροι συγκόλλησης	
Λειτουργίες	

5.2.3 Lock/unlock (Set up 551)

Επιτρέπει το μπλοκάρισμα των οργάνων ελέγχου και την εισαγωγή ενός κωδικού ασφαλείας.

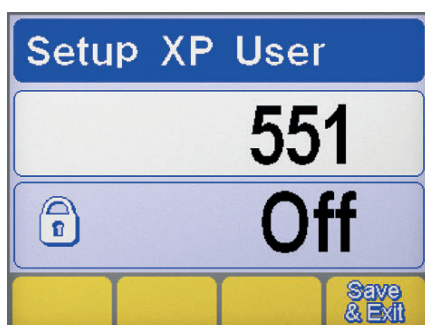

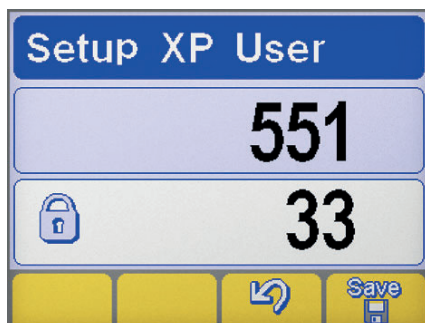

Επιλογή παραμέτρου

- ▶ Μπείτε στο set up, πατώντας το πλήκτρο encoder, για 5 τουλάχιστον δευτερόλεπτα.
- ▶ Επιλέξτε την παράμετρο που θέλετε (551).
- ▶ Ενεργοποιήστε τη ρύθμιση της επιλεγμένης παραμέτρου, πατώντας το πλήκτρο encoder.



Ορισμός κωδικού

- ▶ Εισάγετε έναν αριθμητικό κωδικό (password), περιστρέφοντας το encoder.
- ▶ Επιβεβαιώστε την ενέργεια πιέζοντας το κουμπί-encoder.
- ▶ Επιβεβαιώστε την ενέργεια, πατώντας το πλήκτρο .
- ▶ Για αποθήκευση της τροποποίησης πιέστε το κουμπί: .

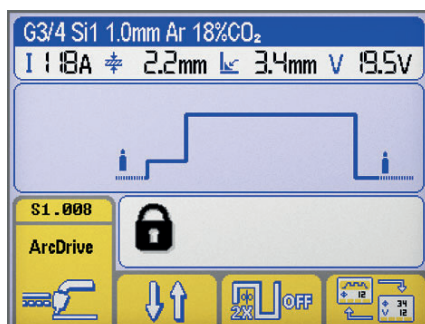

Λειτουργίες πίνακα

- ▶ Μπείτε προσωρινά (5 λεπτά) στις λειτουργίες του πίνακα ελέγχου: περιστρέψτε το encoder και εισάγετε το σωστό αριθμητικό κωδικό.
- ▶ Επιβεβαιώστε την ενέργεια πιέζοντας το κουμπί-encoder.
- ▶ Απελευθερώστε οριστικά τον πίνακα ελέγχου: μπείτε στο set up (σύμφωνα με τις οδηγίες που υπάρχουν παραπάνω) και επαναφέρετε το "off" στην παράμετρο 551.
- ▶ Επιβεβαιώστε την ενέργεια πιέζοντας το κουμπί-encoder.
- ▶ Για αποθήκευση της τροποποίησης πιέστε το κουμπί: .

5.2.4 διαχείριση εξωτερικών εντολών (Set up 602)

Επιτρέπει τη διαχείριση της εξωτερικής παραμέτρου 2 (ελάχιστη τιμή, μέγιστη τιμή, προκαθορισμένη τιμή, επιλεγμένη παράμετρος).



Επιλογή παραμέτρου

- ▶ Μπείτε στο set up, πατώντας το πλήκτρο encoder, για 5 τουλάχιστον δευτερόλεπτα.
- ▶ Επιλέξτε την παράμετρο που θέλετε (602).
- ▶ Μπείτε στη σελίδα "Διαχείριση εξωτερικών εντολών", πατώντας το πλήκτρο encoder.

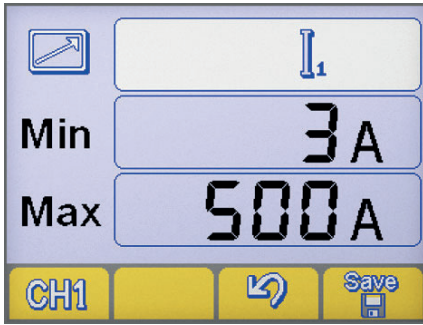

διαχείριση εξωτερικών εντολών

- ▶ Επιλέξτε την επιθυμητή έξοδο ελέγχου RC (CH1, CH2, CH3, CH4), πατώντας το κουμπί.
- ▶ Επιλέξτε την παράμετρο που θέλετε (Min-Max-παράμετρο), πατώντας το πλήκτρο encoder.
- ▶ Ρυθμίστε την παράμετρο που θέλετε (Min-Max-παράμετρο), περιστρέφοντας το encoder.
- ▶ Για αποθήκευση της τροποποίησης πιέστε το κουμπί:
- ▶ Επιβεβαιώστε την ενέργεια, πατώντας το πλήκτρο

5.2.5 Διακρίβωση αντίστασης κυκλώματος (set up 705)

Επιτρέπει τη βαθμονόμηση της γεννήτριας ανάλογα με την αντίσταση του χρησιμοποιούμενου κυκλώματος συγκόλλησης.

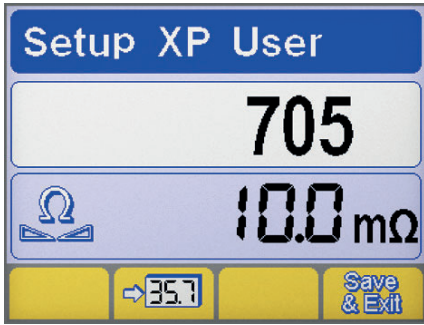

Επιλογή παραμέτρου

- ▶ Μπείτε στο set up, πατώντας το πλήκτρο encoder, για 5 τουλάχιστον δευτερόλεπτα.
- ▶ Επιλέξτε την παράμετρο που θέλετε (705).
- ▶ Ενεργοποιήστε τη ρύθμιση της επιλεγμένης παραμέτρου, πατώντας το πλήκτρο encoder.
- ▶ Συνδέστε τη γεννήτρια στο κύκλωμα συγκόλλησης (πάγκος ή τεμάχιο).
- ▶ Αφαιρέστε το κάλυμμα για να αποκαλυφθεί το tip ακροφυσίου της σιμπίδας. (MIG/MAG)

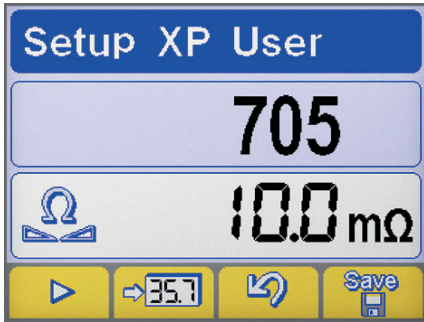

κυκλώματος

- ▶ Φέρτε σε ηλεκτρική επαφή την αιχμή του οδηγού σύρματος και το προς συγκόλληση κομμάτι. (MIG/MAG)
- ▶ Πατήστε το πλήκτρο για να αρχίσετε τη διαδικασία.
- ▶ Κρατήστε την επαφή τουλάχιστον για ένα δευτερόλεπτο.
- ▶ Η τιμή που εμφανίζεται στην οθόνη ενημερώνεται μετά τη βαθμονόμηση.
- ▶ Επιβεβαιώστε την ενέργεια, πατώντας το πλήκτρο
- ▶ Επιβεβαιώστε την ενέργεια, πατώντας το πλήκτρο
- ▶ Για αποθήκευση της τροποποίησης και έξοδο από το set up πιέστε το κουμπί:

5.2.6 Όρια επιφυλακής (Set up 801)

Επιτρέπει τον προγραμματισμό των ορίων προσοχής και των ορίων επιφυλακής.

Επιτρέπει τον έλεγχο του τρόπου συγκόλλησης, καθορίζοντας κάποια όρια προσοχής και όρια επιφυλακής, στις βασικές μετρήσιμες παραμέτρους.

Επιτρέπει τον επιμελή έλεγχο των διαφόρων φάσεων συγκόλλησης.

βλ. παράγραφο "Όρια επιφυλακής (Set up 801)".



- Ρεύμα συγκόλλησης
- Καταγραφή παροχής αερί
- Καταγραφή ρεύματος (μοτέρ 1)
- Καταγραφή παροχής ψυκτικού υγρού
- Καταγραφή θερμοκρασία ψυκτικού υγρού

- Τάση συγκόλλησης
- Ταχύτητα μετατόπισης ρομπότ
- Καταγραφή ρεύματος (μοτέρ 2)
- Ταχύτητα σύρματος

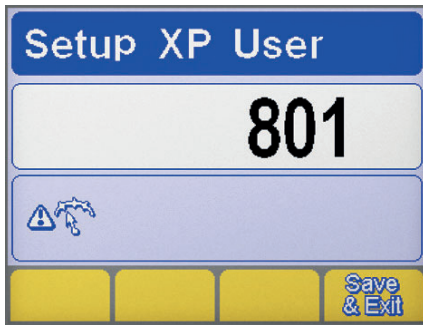
Επιλογή παραμέτρου

- ▶ Μπείτε στο set up, πατώντας το πλήκτρο encoder, για 5 τουλάχιστον δευτερόλεπτα.
- ▶ Επιλέξτε την παράμετρο που θέλετε (801).
- ▶ Μπείτε στη σελίδα "Όρια επιφυλακής", πατώντας το πλήκτρο encoder.

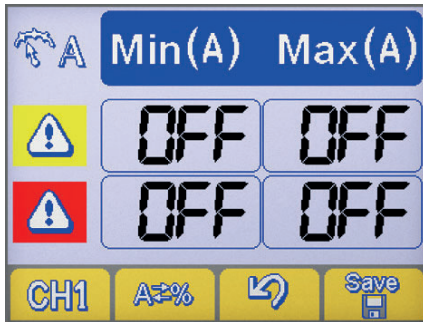
Επιλογή της παραμέτρου

- ▶ Επιλέξτε την παράμετρο που θέλετε, πατώντας το πλήκτρο **CH1**.
- ▶ Επιλέξτε τον τρόπο ρύθμισης των ορίων επιφυλακής, πατώντας το πλήκτρο **A≠%**.

Α≠% Προγραμματισμός μηχανήματος

A/V Απόλυτη τιμή

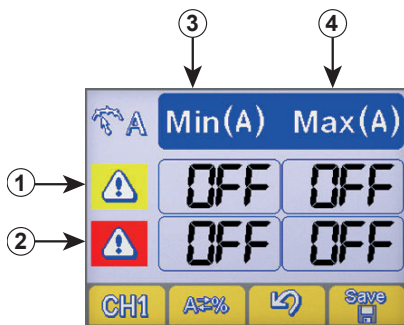
% Ποσοστιαία τιμή

Προγραμματισμός ορίων επιφυλακής

- 1 Γραμμή των ορίων προσοχής
- 2 Γραμμή των ορίων συναγερμού
- 3 Στήλη των ελάχιστων σταθμών
- 4 Στήλη των μέγιστων σταθμών

- ▶ Επιλέξτε τη θέση που θέλετε, πατώντας το πλήκτρο encoder (η επιλεγμένη θέση επισημαίνεται με το μαυρισμένο φόντο).
- ▶ Ρυθμίστε τη στάθμη του ορίου που επιλέξατε, περιστρέφοντας το encoder.
- ▶ Για αποθήκευση της τροποποίησης πιέστε το κουμπί: **Save**.

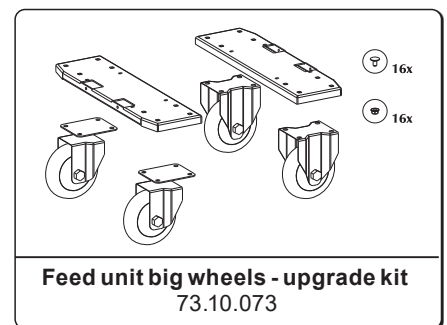
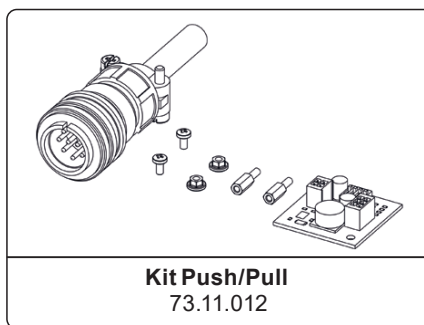
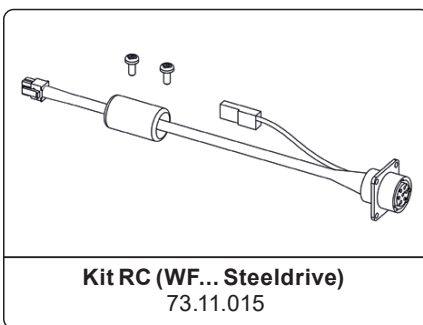

- ▶ Σε περίπτωση που ξεπεραστεί κάποιο όριο προσοχής, στον πίνακα ελέγχου εμφανίζεται μία προειδοποιητική ένδειξη.
- ▶ Σε περίπτωση που ξεπεραστεί κάποιο όριο επιφυλακής (συναγερμού), στον πίνακα ελέγχου εμφανίζεται μία προειδοποιητική ένδειξη και μπλοκάρονται αμέσως όλες οι λειτουργίες συγκόλλησης.
- ▶ Μπορείτε να ενεργοποιήσετε τα φίλτρα έναρξης και τέλους συγκόλλησης, για να αποφύγετε την εμφάνιση ενδείξεων σφάλματος κατά την έναυση και το σβήσιμο του τόξου (βλ. παράγραφο "Set up" - παράμετροι 802-803-804).

6. ΑΞΕΣΟΥΑΡ

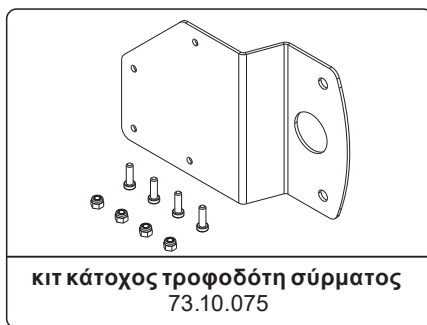
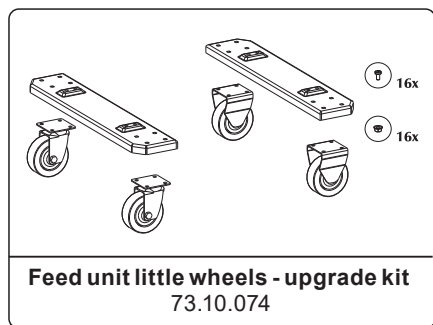

*Συναρμολόγησης του εργοστασίου
βλ. παράγραφο "ΕΓΚΑΤΑΣΤΑΣΗ ΚΙΤ/ ΑΞΕΣΟΥΑΡ".

7. ΣΥΝΤΗΡΗΣΗ



Η διάταξη πρέπει να συντηρείται τακτική, σύμφωνα με τις οδηγίες του κατασκευαστή. Όλες οι θυρίδες πρόσβασης και συντήρησης, καθώς και τα καπάκια, πρέπει να είναι κλειστά και καλά στερεωμένα, όταν η συσκευή βρίσκεται σε λειτουργία. Απαγορεύεται οποιαδήποτε μετατροπή της διάταξης. Μην επιτρέψετε τη συσσώρευση μεταλλικής σκόνης γύρω από τα πτερύγια αερισμού.



Η ενδεχόμενη συντήρηση πρέπει να εκτελείται μόνο από εξειδικευμένους τεχνικούς. Η επισκευή ή η αντικατάσταση εξαρτημάτων της διάταξης από μη εξειδικευμένο προσωπικό έχει ως συνέπεια την άμεση ακύρωση της εγγύησης του προϊόντος. Η ενδεχόμενη επισκευή ή αντικατάσταση εξαρτημάτων της διάταξης, πρέπει να γίνεται αποκλειστικά από εξειδικευμένους τεχνικούς.



Διακόπτετε την τροφοδοσία ρεύματος, πριν από κάθε επέμβαση!

7.1 Περιοδικοί έλεγχοι



Καθαρίστε το εσωτερικό με πεπιεσμένο αέρα σε χαμηλή πίεση και μαλακό πινέλο. Ελέγχετε τις ηλεκτρικές συνδέσεις και όλα τα καλώδια σύνδεσης.

7.2 Ευθύνη



Σε περίπτωση που δεν γίνεται η συνιστώμενη συντήρηση, παύει η ισχύς όλων των εγγυήσεων και ο κατασκευαστής απαλλάσσεται από οποιαδήποτε ευθύνη. Ο κατασκευαστής δεν φέρει καμία ευθύνη, σε περίπτωση που ο χειριστής δε συμμορφωθεί με τις οδηγίες. Για κάθε αμφιβολία και/ή πρόβλημα, μη διστάσετε να απευθυνθείτε στο πλησιέστερο κέντρο τεχνικής υποστήριξης.

8. ΚΩΔΙΚΟΪ ΣΥΝΑΓΕΡΜΩΝ (ΑΛΑΡΜ)



ΣΥΝΑΓΕΡΜΟΣ

Η επέμβαση ενός συναγερμού ή η υπέρβαση ενός κρίσιμου ορίου επιτήρησης, προκαλεί μια οπτική σήμανση στον πίνακα χειριστηρίων και την άμεση διακοπή των εργασιών συγκόλλησης.





ΠΡΟΣΟΧΗ

Η υπέρβαση ενός ορίου επιφυλακής ενεργοποιεί μία οπτική σήμανση στον πίνακα χειρισμού, αλλά επιτρέπει τη συνέχιση της διαδικασίας συγκόλλησης.

Στη συνέχεια παρουσιάζονται όλοι οι συναγερμοί και όλα τα όρια επιτήρησης σχετικά με την εγκατάσταση.

 E01	Υπερθέρμανση		 E02	Υπερθέρμανση	
 E05	Υπερένταση		 E07	Ανωμαλία συστήματος τροφοδοσίας του κινητήρα έλξης σύρματος	
 E08	Αποκλεισμένος κινητήρας		 E10	Υπερένταση μονάδας ισχύος (Inverter)	
 E12.1	Σφάλμα επικοινωνίας WF1		 E13	Σφάλμα επικοινωνίας (FP)	

 E14.xx	Μη έγκυρο πρόγραμμα ο υποκωδικός του σφάλματος υποδηλώνει τον αριθμό της εργασίας που διαγράφηκε		 E15	Μη έγκυρο πρόγραμμα	
 E16.1	Σφάλμα επικοινωνίας RI 1000/2000/3000 (CAN bus)		 E16.2	Σφάλμα επικοινωνίας RI 3000 (Modbus)	
 E16.3	Σφάλμα επικοινωνίας RI 1000/2000		 E18.xx	Μη έγκυρο πρόγραμμα ο υποκωδικός του σφάλματος υποδηλώνει τον αριθμό της εργασίας που διαγράφηκε	
 E19	Σφάλμα διαμόρφωσης εγκατάστασης		 E19.1	Σφάλμα διαμόρφωσης εγκατάστασης	
 E19.11	Σφάλμα διαμόρφωσης εγκατάστασης (WF)		 E20	Βλάβη μνήμης	
 E21	Απώλεια δεδομένων		 E23	Μη διαθέσιμα προγράμματα συγκόλλησης	
 E27	Βλάβη μνήμης (RTC)		 E32	Απώλεια δεδομένων	
 E33.1	Σφάλμα διαμόρφωσης εγκατάστασης (LCD 3.5")		 E33.3	Σφάλμα επικοινωνίας (ACTIVATION KEY)	
 E33.4	Σφάλμα επικοινωνίας (ACTIVATION KEY)		 E40	Ανωμαλία τροφοδοσίας εγκατάστασης	
 E43	Απουσία ψυκτικού υγρού		 E44	Απουσία αερίου	
 E48	Απουσία σύρματος (Αυτοματισμοί και ρομπότ)		 E50	Κολλημένο σύρμα (Αυτοματισμοί και ρομπότ)	
 E54	Υπέρβαση ορίου έντασης (Κατώτερο όριο)		 E55	Υπέρβαση ορίου έντασης (Ανώτερο όριο)	
 E56	Υπέρβαση ορίου τάσης (Κατώτερο όριο)		 E57	Υπέρβαση ορίου τάσης (Ανώτερο όριο)	
 E58	Υπέρβαση ορίου ροής αερίου (Κατώτερο όριο)		 E59	Υπέρβαση ορίου ροής αερίου (Ανώτερο όριο)	
 E62	Υπέρβαση ορίου έντασης (Κατώτερο όριο)		 E63	Υπέρβαση ορίου έντασης (Ανώτερο όριο)	
 E64	Υπέρβαση ορίου τάσης (Κατώτερο όριο)		 E65	Υπέρβαση ορίου τάσης (Ανώτερο όριο)	
 E66	Υπέρβαση ορίου ροής αερίου (Κατώτερο όριο)		 E67	Υπέρβαση ορίου ροής αερίου (Ανώτερο όριο)	

E71 Υπερθέρμανση ψυκτικού υγρού	E74 Υπέρβαση ορίου ρεύματος κινητήρα 1
E76 Υπέρβαση ορίου ροής ψυκτικού υγρού	E77 Υπέρβαση ορίου θερμοκρασίας ψυκτικού υγρού
E80 Απουσία σύρματος (wire end)	E81 Υπερένταση (αντλία WU)
E82 Σφάλμα επικοινωνίας (WU)	E83 Εμπλοκή αντλίας
E99.2 Συναγερμός διαμόρφωσης διάταξης (inverter)	E99.3 Συναγερμός διαμόρφωσης διάταξης (FP)
E99.4 Συναγερμός διαμόρφωσης διάταξης (FP)	E99.5 Συναγερμός διαμόρφωσης διάταξης (FP)
E99.6 Συναγερμός διαμόρφωσης διάταξης	E99.11 Βλάβη μνήμης

9. ΔΙΑΓΝΩΣΗ ΠΡΟΒΛΗΜΑΤΩΝ ΚΑΙ ΛΥΣΕΙΣ

Εμπλοκή προώθησης σύρματος

Αιτία

- » Ελαττωματικό μπουτόν τσιμπίδας.
- » Ακατάλληλα ή ελαττωματικά ράουλα.
- » Ελαττωματικός ηλεκτρομειωτήρας.
- » Φθορά περιβλήματος τσιμπίδας.
- » Διακοπή τροφοδότη σύρματος.
- » Ακανόνιστο τύλιγμα στο καρούλι.
- » Ακροφύσιο (μπεκ) τσιμπίδας λειωμένο (σύρμα κολλημένο).

Λύση

- » Αντικαταστήστε το ελαττωματικό εξάρτημα.
- » Απευθυνθείτε στο πλησιέστερο κέντρο τεχνικής υποστήριξης, για την επισκευή της διάταξης.
- » Αντικαταστήστε τα ράουλα.
- » Αντικαταστήστε το ελαττωματικό εξάρτημα.
- » Απευθυνθείτε στο πλησιέστερο κέντρο τεχνικής υποστήριξης, για την επισκευή της διάταξης.
- » Αντικαταστήστε το ελαττωματικό εξάρτημα.
- » Απευθυνθείτε στο πλησιέστερο κέντρο τεχνικής υποστήριξης, για την επισκευή της διάταξης.
- » Ελέγξτε τη σύνδεση με τη γεννήτρια.
- » Συμβουλευθείτε την παράγραφο "Σύνδεση".
- » Απευθυνθείτε στο πλησιέστερο κέντρο τεχνικής υποστήριξης, για την επισκευή της διάταξης.
- » Αποκαταστήστε τις ομαλές συνθήκες ξετυλίγματος του καρουλιού ή αντικαταστήστε το.
- » Αντικαταστήστε το ελαττωματικό εξάρτημα.

Ακανόνιστη πρόωση σύρματος

Αιτία

- » Ελαττωματικό μπουτόν τσιμπίδας.
- » Ακατάλληλα ή ελαττωματικά ράουλα.
- » Ελαττωματικός ηλεκτρομειωτήρας.
- » Φθορά περιβλήματος τσιμπίδας.

Λύση

- » Αντικαταστήστε το ελαττωματικό εξάρτημα.
- » Απευθυνθείτε στο πλησιέστερο κέντρο τεχνικής υποστήριξης, για την επισκευή της διάταξης.
- » Αντικαταστήστε τα ράουλα.
- » Αντικαταστήστε το ελαττωματικό εξάρτημα.
- » Απευθυνθείτε στο πλησιέστερο κέντρο τεχνικής υποστήριξης, για την επισκευή της διάταξης.
- » Αντικαταστήστε το ελαττωματικό εξάρτημα.
- » Απευθυνθείτε στο πλησιέστερο κέντρο τεχνικής υποστήριξης, για την επισκευή της διάταξης.

» Κακή ρύθμιση φρένου βάσης καρουλίου ή διατάξεων εμπλοκής ράουλων.

» Ξεσφίξτε το φρένο.
» Αυξήστε την πίεση στα ράουλα.

Εγκλωβισμός σκουριάς

Αιτία

» Ατελής απομάκρυνση της σκουριάς.
» Πολύ μεγάλη διάμετρος ηλεκτροδίου.
» Λανθασμένη προετοιμασία άκρων.
» Λανθασμένος τρόπος εκτέλεσης συγκόλλησης.

Λύση

» Καθαρίστε καλά τα κομμάτια, πριν τη συγκόλληση.
» Χρησιμοποιήστε ηλεκτρόδιο με μικρότερη διάμετρο.
» Αυξήστε το άνοιγμα του διάκενου.
» Μειώστε την απόσταση μεταξύ ηλεκτροδίου και τεμαχίου.
» Κινηθείτε με ομαλό ρυθμό, σε όλες τις φάσεις συγκόλλησης.

Φυσήματα

Αιτία

» Ανεπαρκής προστασία του αερίου.

Λύση

» Ρυθμίστε σωστά τη ροή αερίου.
» Βεβαιωθείτε ότι το στόμιο και το μπεκ αερίου της τσιμπίδας βρίσκονται σε καλή κατάσταση.

Κολλήματα

Αιτία

» Λανθασμένο μήκος τόξου.
» Λανθασμένες παράμετροι συγκόλλησης.
» Λανθασμένος τρόπος εκτέλεσης συγκόλλησης.
» Μεγάλες διαστάσεις των προς συγκόλληση κομματιών.
» Λανθασμένη δυναμική τόξου.

Λύση

» Αυξήστε την απόσταση μεταξύ ηλεκτροδίου και κομματιού.
» Αυξήστε την τάση συγκόλλησης.
» Αυξήστε το ρεύμα συγκόλλησης.
» Αυξήστε την τάση συγκόλλησης.
» Αυξήστε περισσότερο την γωνία κλίσης της τσιμπίδας.
» Αυξήστε το ρεύμα συγκόλλησης.
» Αυξήστε την τάση συγκόλλησης.
» Αυξήστε την επαγωγική τιμή του κυκλώματος.

Ρηγματώσεις στις άκρες

Αιτία

» Λανθασμένες παράμετροι συγκόλλησης.
» Λανθασμένο μήκος τόξου.
» Λανθασμένος τρόπος εκτέλεσης συγκόλλησης.
» Ανεπαρκής προστασία του αερίου.

Λύση

» Ελαττώστε το ρεύμα συγκόλλησης.
» Μειώστε την απόσταση μεταξύ ηλεκτροδίου και τεμαχίου.
» Μειώστε την τάση συγκόλλησης.
» Μειώστε την ταχύτητα πλευρικής ταλάντωσης κατά το γέμισμα.
» Ελαττώστε την ταχύτητα προώθησης της συγκόλλησης.
» Χρησιμοποιείτε αέρια κατάλληλα για τα προς συγκόλληση υλικά.

Οξειδώσεις

Αιτία

» Ανεπαρκής προστασία του αερίου.

Λύση

» Ρυθμίστε σωστά τη ροή αερίου.
» Βεβαιωθείτε ότι το στόμιο και το μπεκ αερίου της τσιμπίδας βρίσκονται σε καλή κατάσταση.

Πόροι

Αιτία

» Γράσο, βερνίκι, σκουριά ή βρωμιά στα προς συγκόλληση κομμάτια.
» Γράσο, βερνίκι, σκουριά ή βρωμιά στο υλικό συγκόλλησης (κόλληση).
» Υγρασία στο υλικό συγκόλλησης (κόλληση).
» Λανθασμένο μήκος τόξου.
» Υγρασία στο αέριο συγκόλλησης.

Λύση

» Καθαρίστε καλά τα κομμάτια, πριν τη συγκόλληση.
» Χρησιμοποιείτε πάντοτε προϊόντα και υλικά καλής ποιότητας.
» Διατηρείτε πάντοτε σε τέλεια κατάσταση το υλικό συγκόλλησης (κόλληση).
» Χρησιμοποιείτε πάντοτε προϊόντα και υλικά καλής ποιότητας.
» Διατηρείτε πάντοτε σε τέλεια κατάσταση το υλικό συγκόλλησης (κόλληση).
» Μειώστε την απόσταση μεταξύ ηλεκτροδίου και τεμαχίου.
» Μειώστε την τάση συγκόλλησης.
» Χρησιμοποιείτε πάντοτε προϊόντα και υλικά καλής ποιότητας.
» Διατηρείτε σε άριστη κατάσταση τη διάταξη τροφοδοσίας αερίου.

» Ανεπαρκής προστασία του αερίου.

» Ρυθμίστε σωστά τη ροή αερίου.

» Βεβαιωθείτε ότι το στόμιο και το μπεκ αερίου της τσιμπίδας βρίσκονται σε καλή κατάσταση.

» Πολύ γρήγορη στερεοποίηση του λουτρού συγκόλλησης.

» Ελαττώστε την ταχύτητα προώθησης της συγκόλλησης.

» Προθερμαίνετε τα προς συγκόλληση κομμάτια.

» Αυξήστε το ρεύμα συγκόλλησης.

Ρωγμές εν θερμώ

Αιτία

» Λανθασμένες παράμετροι συγκόλλησης.

» Γράσο, βερνίκι, σκουριά ή βρωμιά στα προς συγκόλληση κομμάτια.

» Γράσο, βερνίκι, σκουριά ή βρωμιά στο υλικό συγκόλλησης (κόλληση).

» Λανθασμένος τρόπος εκτέλεσης συγκόλλησης.

» Τα προς συγκόλληση κομμάτια έχουν διαφορετικά χαρακτηριστικά.

Λύση

» Ελαττώστε το ρεύμα συγκόλλησης.

» Καθαρίστε καλά τα κομμάτια, πριν τη συγκόλληση.

» Χρησιμοποιείτε πάντοτε προϊόντα και υλικά καλής ποιότητας.

» Διατηρείτε πάντοτε σε τέλεια κατάσταση το υλικό συγκόλλησης (κόλληση).

» Εφαρμόστε την κατάλληλη διαδικασία, για τον τύπο του προς συγκόλληση συνδέσμου.

» Επαλείψτε πάστα ή λίπος, πριν τη συγκόλληση.

Ρωγμές εν ψυχρώ

Αιτία

» Υγρασία στο υλικό συγκόλλησης (κόλληση).

» Ιδιαίτερη γεωμετρική μορφή του προς συγκόλληση συνδέσμου.

Λύση

» Χρησιμοποιείτε πάντοτε προϊόντα και υλικά καλής ποιότητας.

» Διατηρείτε πάντοτε σε τέλεια κατάσταση το υλικό συγκόλλησης (κόλληση).

» Προθερμαίνετε τα προς συγκόλληση κομμάτια.

» Θέρμανση μετά τη συγκόλληση/κοπή.

» Εφαρμόστε την κατάλληλη διαδικασία, για τον τύπο του προς συγκόλληση συνδέσμου.

10. ΟΔΗΓΙΕΣ ΧΡΗΣΗΣ

10.1 Συγκόλλησης με συνεχές συρμα (mig/mag)

Εισαγωγή

Ένα σύστημα MIG αποτελείται από μια γεννήτρια συνεχούς ρεύματος, έναν τροφοδότη και ένα καρούλι σύρματος, μια τσιμπίδα και το αέριο

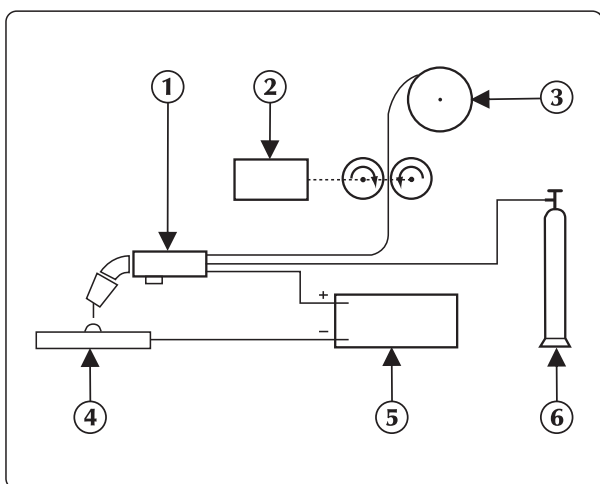

Διάταξη χειροκίνητης συγκόλλησης

Το ρεύμα μεταφέρεται στο τόξο μέσω του τηκόμενου ηλεκτροδίου (σύρμα με θετική πολικότητα);

Στη διαδικασία αυτή το λειωμένο μέταλλο μεταφέρεται πάνω στο συγκολλούμενο κομμάτι, με τη βοήθεια του τόξου.

Η τροφοδοσία του σύρματος είναι απαραίτητη για την αποκατάσταση του λειωμένου συγκολλητικού κατά τη συγκόλληση.

1. Τσιμπίδα
2. Τροφοδότης σύρματος
3. Σύρμα συγκόλλησης
4. Τεμάχιο προς συγκόλληση
5. Γεννήτρια
6. Φιάλη

Μέθοδοι εργασίας

Στη συγκόλληση με προστασία αερίου, ο τρόπος σύμφωνα με τον οποίο οι σταγόνες αποκολλώνται από το ηλεκτρόδιο καθορίζει τα δύο συστήματα μεταφοράς.

Η πρώτη μέθοδος που ονομάζεται "ΜΕΤΑΦΟΡΑ ΜΕ ΒΡΑΧΥΚΥΚΛΩΜΑ (SHORT-ARC)", φέρνει σε άμεση επαφή το ηλεκτρόδιο με το λουτρό. Δημιουργείται ένα βραχυκύκλωμα, που έχει ως αποτέλεσμα το λιώσιμο και την κοπή του σύρματος. Μετά από αυτό, το τόξο ανάβει ξανά και ο κύκλος επαναλαμβάνεται.

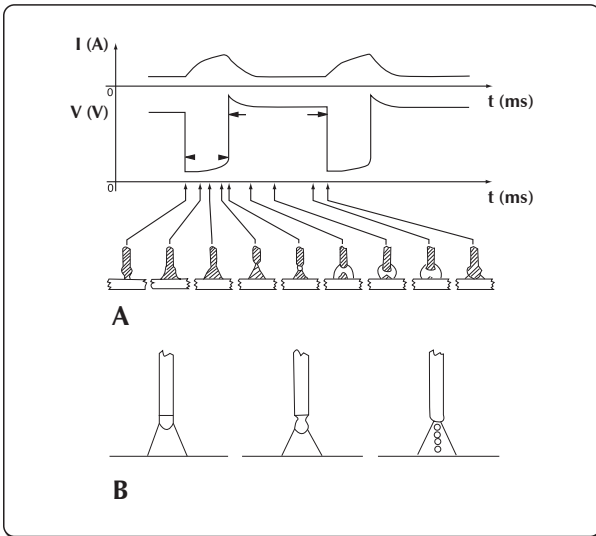

Κύκλος SHORT και συγκόλληση SPRAY ARC

Μια άλλη μέθοδος για να πετύχουμε τη μεταφορά των σταγόνων είναι η εμπομαζόμενη "ΜΕΤΑΦΟΡΑ ΜΕ ΨΕΚΑΣΜΟ (SPRAY-ARC)", που επιτρέπει στις σταγόνες να αποκολληθούν από το ηλεκτρόδιο και, σε δεύτερο χρόνο, να φτάσουν στο λουτρό συγκόλλησης.

Παράμετροι συγκόλλησης

Η ορατότητα του τόξου μειώνει την ανάγκη της απόλυτης τήρησης των πινάκων ρύθμισης, εκ μέρους του χειριστή, ο οποίος έχει τη δυνατότητα να ελέγχει άμεσα το λουτρό τήξης.

- Η τάση επηρεάζει άμεσα τη μορφή της ραφής, αλλά οι διαστάσεις της συγκολλημένης επιφάνειας μπορεί να ποικίλουν ανάλογα με τις απαιτήσεις, ρυθμίζοντας με το χέρι την κίνηση της σαιμπίδας, έτσι ώστε να εναποτίθενται μεταβλητές ποσότητες υλικού, με σταθερή όμως τάση.
- Η ταχύτητα προώθησης του σύρματος είναι σε συνάρτηση την τιμή του ρεύματος συγκόλλησης.

Στα δύο παρακάτω σχήματα παρουσιάζονται οι σχέσεις ανάμεσα στις διάφορες παραμέτρους συγκόλλησης.

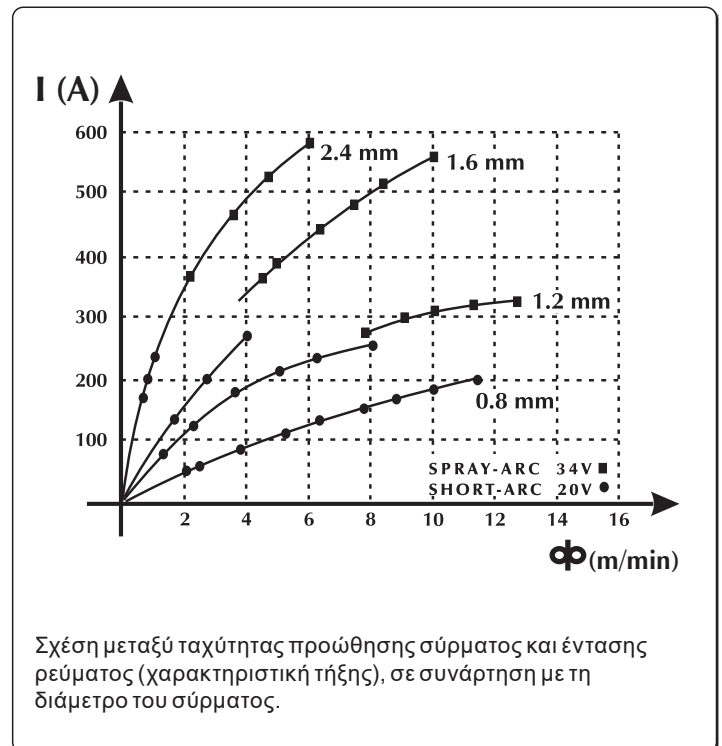
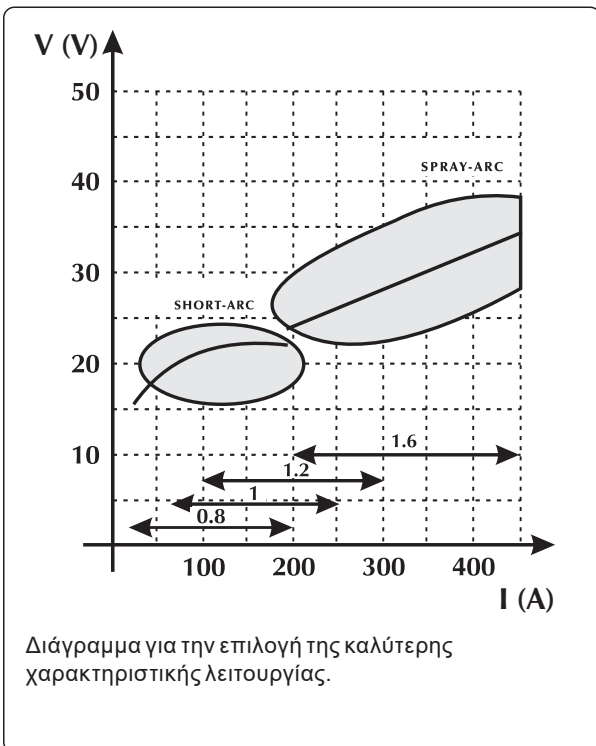

Βοηθητικός πίνακας για την επιλογή των παραμετρών συγκόλλησης, με αναφορά στις πιο τυπικές εφαρμογές και στα συρματα που χρησιμοποιούνται πιο συχνά

Τάση τόξου

Ø 0,8 mm

Ø 1,0-1,2 mm

Ø 1,6 mm

Ø 2,4 mm

16V - 22V
SHORT - ARC

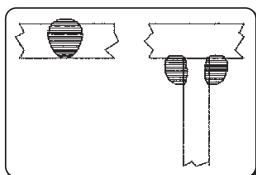

60 - 160 A

Χαμηλή διείσδυση για μικρό πάχος

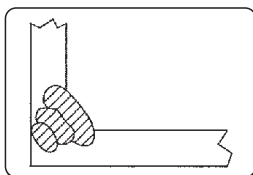

100 - 175 A

Καλός έλεγχος της διείσδυσης και της τήξης

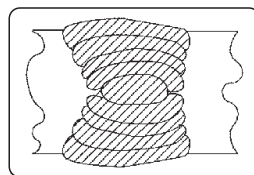

120 - 180 A

Καλή τήξη σε οριζόντιο και κατακόρυφο επίπεδο



150 - 200 A

Δεν χρησιμοποιείται

24V - 28V
SEMI SHORT-ARC
(Μεταβατική ζώνη)

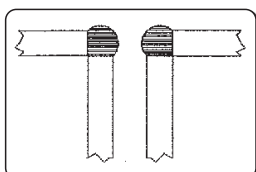

150 - 250 A

Αυτόματη γωνιακή συγκόλληση

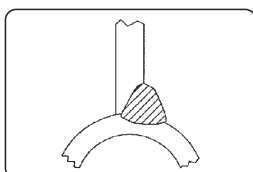

200 - 300 A

Αυτόματη συγκόλληση με υψηλή τάση

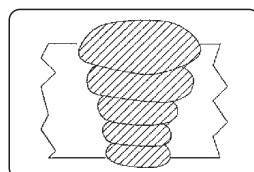

250 - 350 A

Αυτόματη κατεβατή συγκόλληση



300 - 400 A

Δεν χρησιμοποιείται

30V - 45V
SPRAY - ARC

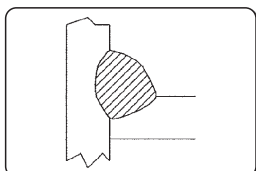

150 - 250 A

Χαμηλή διείσδυση με ρύθμιση στα 200 A

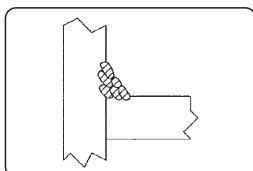

200 - 350 A

Αυτόματη συγκόλληση με πολλαπλά περάσματα

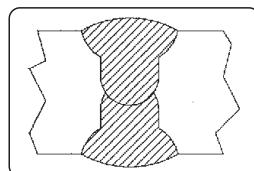

300 - 500 A

Καλή διείσδυση σε κατεβατή

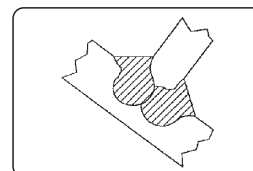

500 - 750 A

Καλή διείσδυση, υψηλή εναπόθεση σε μεγάλο πάχος

Unalloyed steel

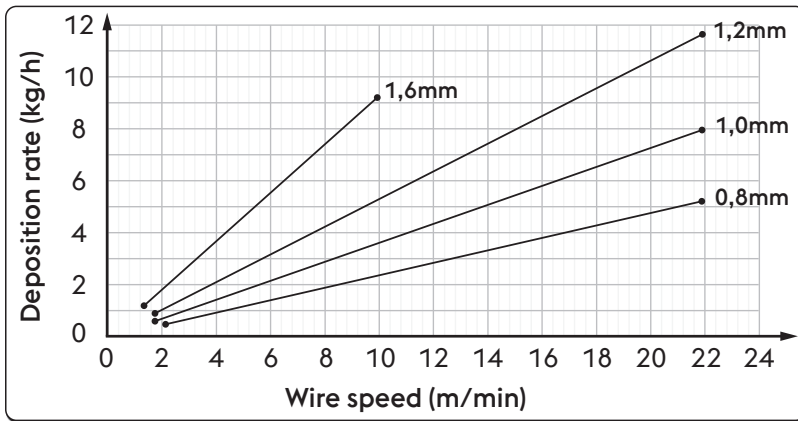

Ø	Wire speed	Deposition rate
0,8 mm	2,0 m/min	0,5 kg/h
	22,0 m/min	5,3 kg/h
1,0 mm	1,6 m/min	0,6 kg/h
	22,0 m/min	8,1 kg/h
1,2 mm	1,6 m/min	0,9 kg/h
	22,0 m/min	11,7 kg/h
1,6 mm	1,2 m/min	1,1 kg/h
	10,0 m/min	9,4 kg/h

High alloyed steel

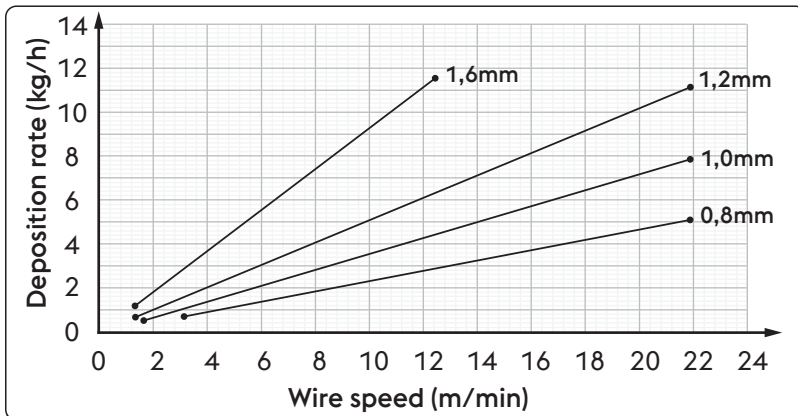

Ø	Wire speed	Deposition rate
0,8 mm	2,0 m/min	0,5 kg/h
	22,0 m/min	5,3 kg/h
1,0 mm	1,6 m/min	0,6 kg/h
	22,0 m/min	8,1 kg/h
1,2 mm	1,6 m/min	0,9 kg/h
	22,0 m/min	11,7 kg/h
1,6 mm	1,2 m/min	1,1 kg/h
	10,0 m/min	9,4 kg/h

Aluminum alloy

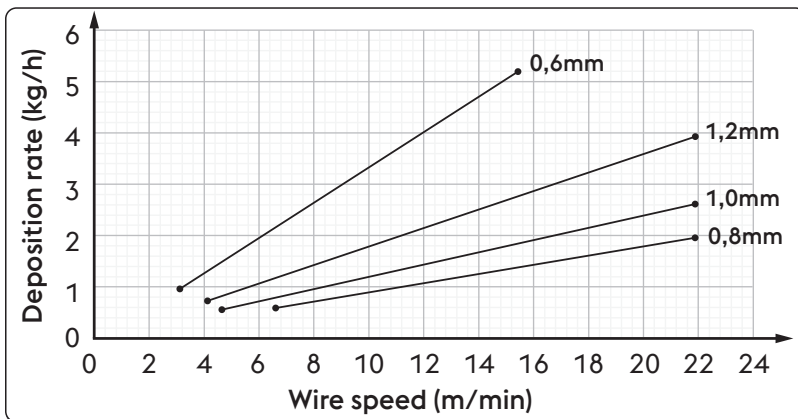

Ø	Wire speed	Deposition rate
0,8 mm	6,5 m/min	0,6 kg/h
	22,0 m/min	2,0 kg/h
1,0 mm	4,5 m/min	0,5 kg/h
	22,0 m/min	2,6 kg/h
1,2 mm	4,0 m/min	0,7 kg/h
	22,0 m/min	4,0 kg/h
1,6 mm	3,0 m/min	0,9 kg/h
	15,5 m/min	5,2 kg/h

Αέρια που χρησιμοποιούνται

Η συγκόλληση MIG-MAG χαρακτηρίζεται κυρίως από τον τύπο του αερίου που χρησιμοποιείται: αδρανές για τη συγκόλληση MIG (Metal Inert Gas), ενεργό για τη συγκόλληση MAG (Metal Active Gas).

- Διοξείδιο του άνθρακα (CO₂)

Χρησιμοποιώντας CO₂ σαν προστατευτικό αέριο επιτυγχάνονται υψηλές επιδόσεις, με μεγάλη ταχύτητα προώθησης και καλές μηχανικές ιδιότητες, σε συνδυασμό με το χαμηλό κόστος λειτουργίας. Παρόλα αυτά, η χρήση αυτού του αερίου δημιουργεί σημαντικά προβλήματα στην τελική χημική σύνθεση των αρμών, επειδή υπάρχει μια απώλεια στοιχείων που οξειδώνονται εύκολα και, ταυτόχρονα, έχουμε τον εμπλουτισμό του τήγματος με άνθρακα.

Η συγκόλληση με καθαρό CO₂ παρουσιάζει και άλλους τύπους προβλημάτων, όπως υπερβολική παρουσία πιτσιλισμάτων και οι πόροι από οξείδιο του άνθρακα.

- Αργό

Αυτό το αδρανές αέριο χρησιμοποιείται καθαρό στη συγκόλληση των ελαφρών κραμάτων, ενώ, για τη συγκόλληση του ανοξείδωτου χάλυβα με χρώμιο-νικέλιο, προτιμάται η προσθήκη οξυγόνου και CO₂ σε ποσοστό 2%. Αυτό δίνει σταθερότητα στο τόξο και καλύτερη μορφή στη ραφή.

- Ήλιο

Αυτό το αέριο χρησιμοποιείται ως εναλλακτική λύση αντί του Αργού και επιτρέπει μεγαλύτερη διείσδυση (σε μεγάλο πάχος) και μεγαλύτερη ταχύτητα προώθησης.

- Μίγμα Αργού-Ηλίου

Επιτυγχάνεται ένα πιο σταθερό τόξο, σε σχέση με αυτό του καθαρού Ηλίου, μεγαλύτερη διείσδυση και ταχύτητα σε σχέση με το Αργό.

- Μίγμα Αργόν-CO₂ και Αργόν-CO₂-Οξυγόνο

Αυτά τα μίγματα χρησιμοποιούνται στη συγκόλληση των σιδηρούχων υλικών κυρίως σε συνθήκες SHORT-ARC, επειδή βελτιώνεται η ειδική θερμική παροχή.

Αυτό δεν αποκλείει τη χρήση του στο SPRAY-ARC.

Συνήθως το μίγμα περιέχει ένα ποσοστό CO₂ μεταξύ 8% και 20% και O₂ γύρω στο 5%.

Συμβουλευτείτε το εγχειρίδιο οδηγιών χρήσης της διάταξης.

Unalloyed steel / High alloyed steel		Aluminum alloy	
Εύρος ρεύματος	Ροή αερίου	Εύρος ρεύματος	Ροή αερίου
3-50 A	10-12 l/min	3-50 A	10-12 l/min
30-100 A	10-14 l/min	30-100 A	10-15 l/min
75-150 A	12-16 l/min	75-150 A	12-18 l/min
150-250 A	14-18 l/min	150-250 A	14-22 l/min
250-400 A	16-20 l/min	250-400 A	16-25 l/min
400-500 A	18-22 l/min	400-500 A	18-30 l/min

11. ΤΕΧΝΙΚΑ ΧΑΡΑΚΤΗΡΙΣΤΙΚΑ

Χαρακτηριστικά μονάδας τροφοδότη σύρματος WF NX 430 SteelDrive		U.M.
Τύπος ηλεκτρομειωτήρα	SL4R-4T	
Ισχύς ηλεκτρομειωτήρα	120	W
Αριθμός ράουλων	4	
Διάμετρος σύρματος / Ράουλο στάνταρ	1.0-1.2	mm
Διάμετρος συρμάτων χρήσης / Ράουλα χρήσης	ταχύτητας προώθησης του σύρματος 0.8-1.6 σύρμα αλουμινίου 1.2-2.4 σύρμα με πυρήνα	mm/Υλικό
Μπουτόν καθαρισμού αερίου	ναι	
Μπουτόν προώθησης σύρματος	ναι	
Κουμπί επαναφοράς του σύρματος	όχι	
Ταχύτητα σύρματος	25 Ø 0.8 - 1.0	m/min
Συνεργίες	ναι	
Εξωτερικές διατάξεις	ναι (προαιρετικό)	
Υποδοχή για τσιμπίδα Push-Pull	ναι (προαιρετικό)	
Διάμετρος καρουλιών	200/300	mm
Διάμετρος εμπρόσθιων τροχών	63/125 (optional)	mm
Διάμετρος οπίσθιων τροχών	63/125 (optional)	mm

Ηλεκτρικά Χαρακτηριστικά WF NX 430 SteelDrive		U.M.
Τάση τροφοδοσίας U1	48	Vdc
Τύπος επικοινωνίας	ΨΗΦΙΑΚΟΣ	
Μέγιστη απορρόφηση ρεύματος I1max	4.5	A

Συντελεστής χρήσης WF NX 430 SteelDrive		U.M.
Συντελεστής χρήσης (40°C)		
(X=50%)	500	A
(X=60%)	470	A
(X=100%)	420	A
Συντελεστής χρήσης (25°C)		
(X=80%)	500	A
(X=100%)	470	A

Φυσικά χαρακτηριστικά WF NX 430 SteelDrive		U.M.
Βαθμός προστασίας IP	IP23S	
Διαστάσεις (ΠxBxΥ)	640x250x460	mm
Βάρος	19.0	Kg
Πρότυπα κατασκευής	EN IEC 60974-5:2019 EN 60974-10/A1:2015	

12. ΠΙΝΑΚΪΔΑ ΧΑΡΑΚΤΗΡΙΣΤΙΚΩΝ

VOESTALPINE BÖHLER WELDING SELCO S.R.L. Via Palladio, 19 - ONARA (PADOVA) - ITALY			
WF NX 430		N°	
EN IEC	60974-5:2019 60974-10/A1:2015 Class A		
	X (40°C)	60%	100%
	I ₂	500A	400A
1	U ₁ 48V	I _{1max} 4.5A	
IP 23 S		UK CA CE EAC	
MADE IN ITALY			

13. ΣΗΜΑΣΪΑ ΠΙΝΑΚΪΔΑΣ ΧΑΡ ΑΚΤΗΡΙΟΤΙΚΩΝ

1		2	
3		4	
5			
	6	6A	6B
	7	7A	7B
8	9	10	
11		UK CA CE EAC	
MADE IN ITALY			

- 1 Σήμα κατασκευαστή
- 2 Επωνυμία και διεύθυνση κατασκευαστή
- 3 Μοντέλο συσκευής
- 4 Αριθ. σειράς
XXXXXXXXXXXX Έτος κατασκευής
- 5 Παραπομπή στα πρότυπα κατασκευής
- 6 Σύμβολο κύκλου διακοπτόμενης λειτουργίας
- 7 Σύμβολο ονομαστικού ρεύματος συγκόλλησης
- 6A Τιμές κύκλου διακοπτόμενης λειτουργίας
- 6B Τιμές κύκλου διακοπτόμενης λειτουργίας
- 7A Τιμές ονομαστικού ρεύματος συγκόλλησης
- 7B Τιμές ονομαστικού ρεύματος συγκόλλησης
- 8 Σύμβολο τροφοδοσίας
- 9 Ονομαστική τάση τροφοδοσίας
- 10 Μέγιστο ονομαστικό ρεύμα τροφοδοσίας
- 11 Βαθμός προστασίας

CE Δήλωση συμμόρφωσης ΕΕ
 EAC Δήλωση συμμόρφωσης EAC
 UKCA Δήλωση συμμόρφωσης UKCA

14. SCHEMA, DIAGRAM, SCHALTPLAN, SCHEMA, ESQUEMA, DIAGRAMA, SCHEMA, KOPPLINGSSCHEMA, OVERSICHT, SKJEMA, KYTKENTÄKAAVIO, ΔΙΑΓΡΑΜΜΑ

WF NX 430 STEELDRIVE (71.01.083)

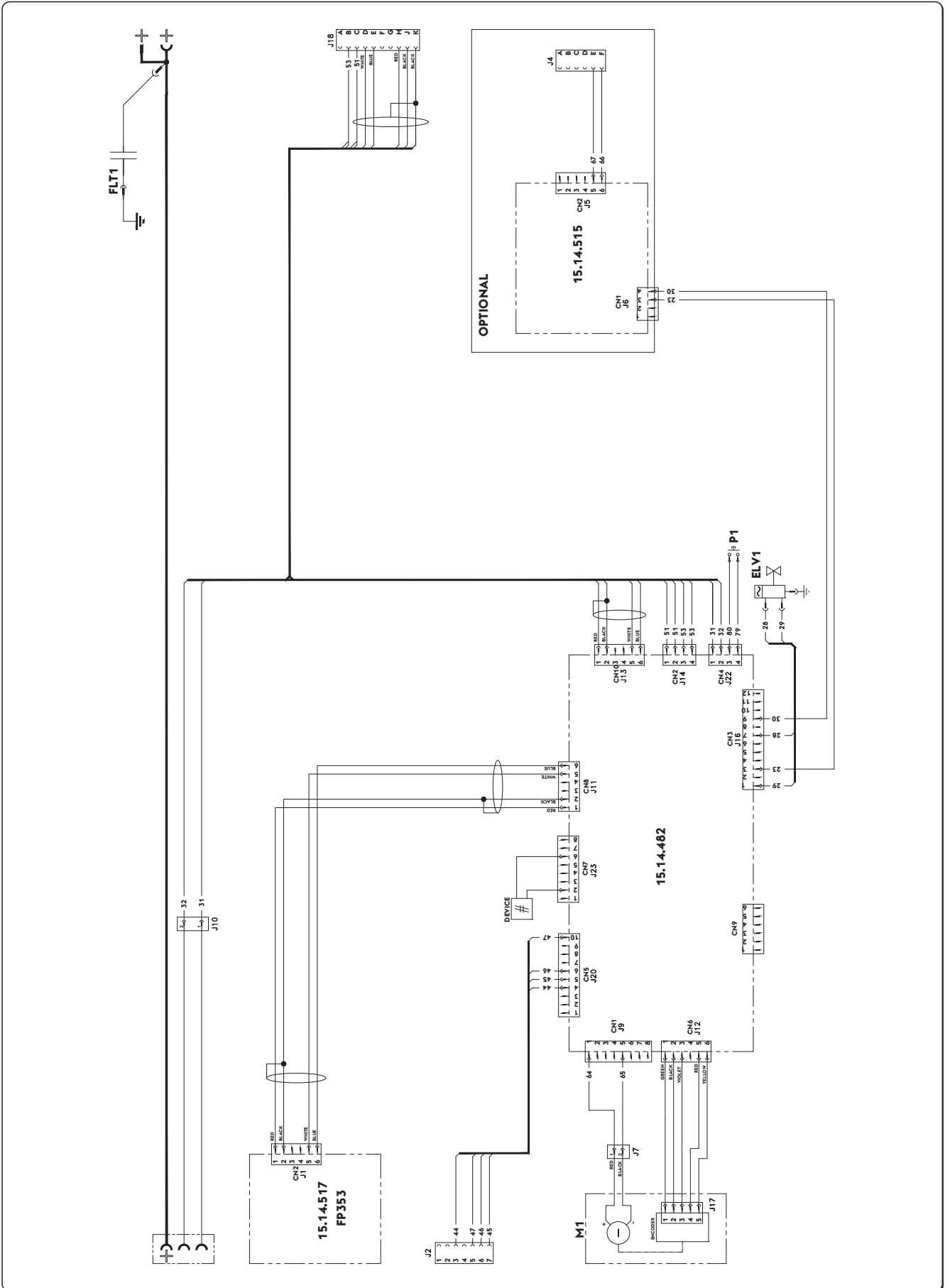

15. CONNETTORI, CONNECTORS, VERBINDER, CONNECTEURS, CONECTORES, CONECTORES, VERBINDINGEN, KONTAKTDON, KONNEKTORER, SKJØTEMUNNSTYKKER, LIITTIMET, ΣΥΝΔΕΤΗΡΕΣ

WF NX 430 STEELDRIVE (71.01.083)

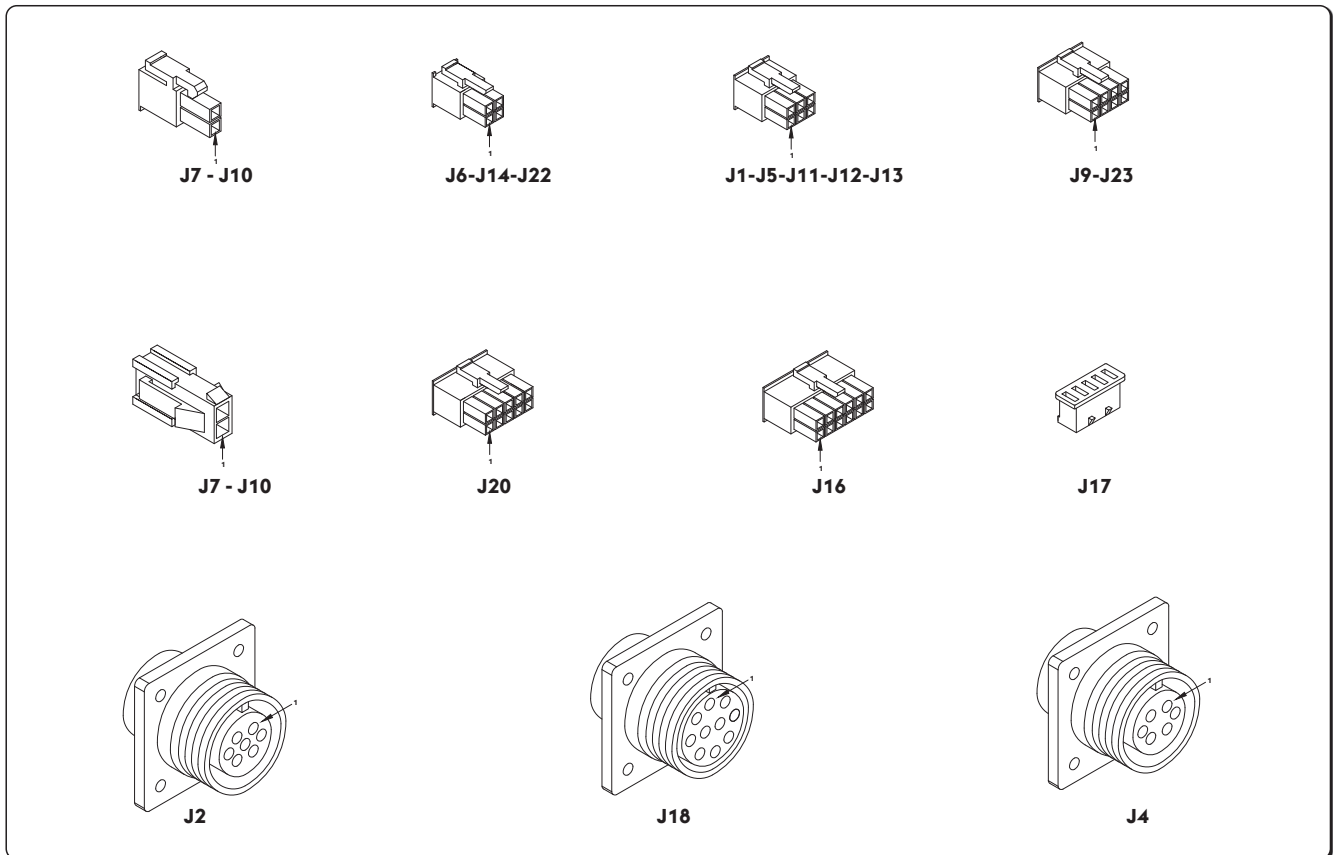

16. LISTA RICAMBI, SPARE PARTS LIST, ERSATZTEILVERZEICHNIS, LISTE DE PIÈCES DÉTACHÉES, LISTA DE REPUESTOS, LISTA DE PEÇAS DE REPOSIÇÃO, LIJST VAN RESERVE ONDERDELEN, RESERVEDELSLISTA, RESERVEDELSLISTE, LISTE OVER RESERVEDELER, VARAOSALUETTELO, ΚΑΤΑΛΟΓΟΣ

WF NX 430 STEELDRIVE (71.01.083)

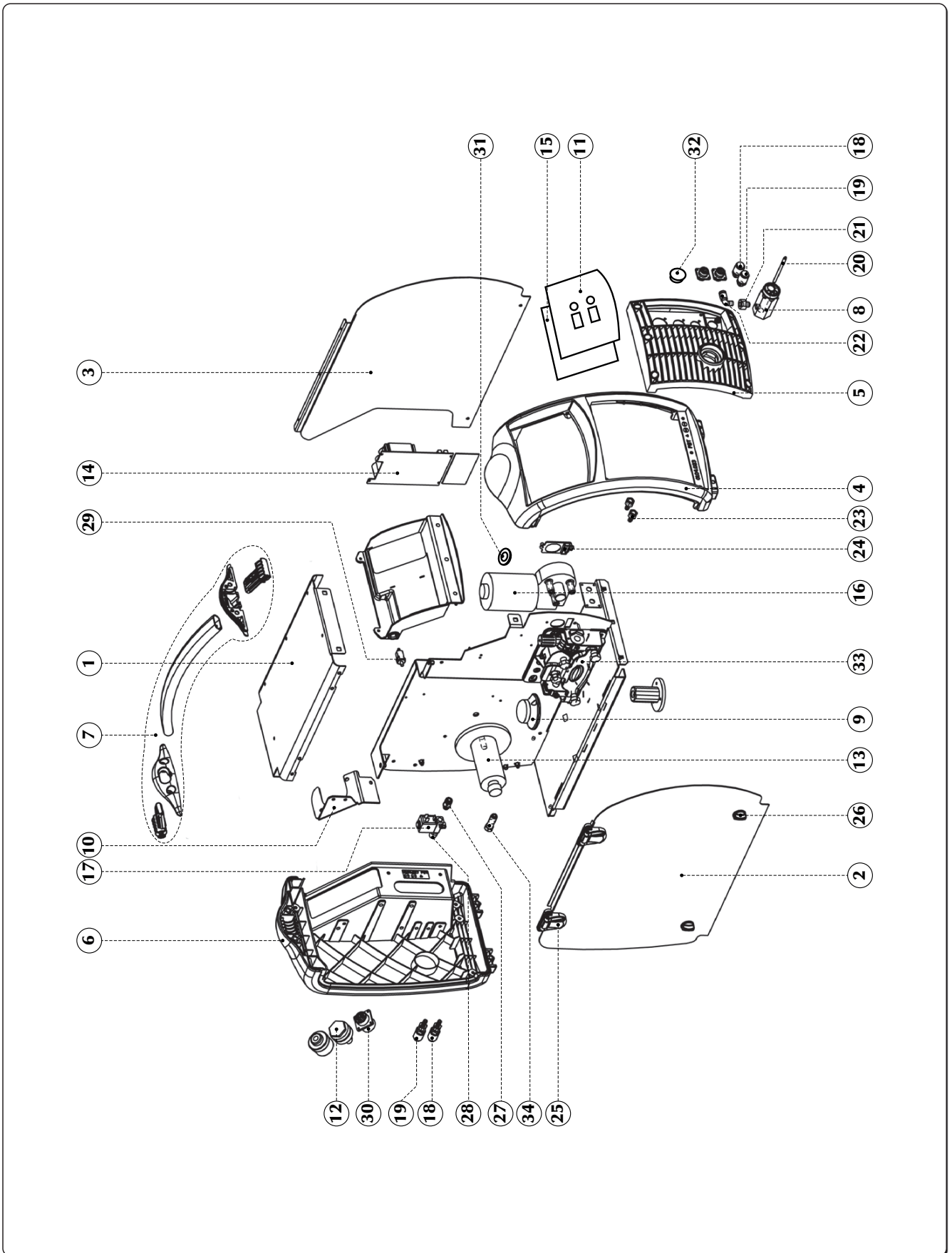

POS.	CODE	ITALIANO	ENGLISH	DEUTSCH	FRANÇAIS	ESPAÑOL
1	02.04.03802	Cofano superiore	Metal cover upper	Oberes gehäuse	Carter supérieur	Chapa superior
2	02.04.03902	Pannello laterale DX	Side panel - RIGHT	Seitenpaneel - RE	Panneau latéral droit	Panel lateral derecho
3	03.07.570	Cofano laterale SX	Side panel - LEFT	Seitenpaneel - LI	Panneau latéral gauche	Panel lateral izquierdo
4	01.04.023	Cornice plastica frontale	Front frame (plastic)	Plastikrahmen, vorne	Encadrement plastique frontal	Marco plástico frente
5	01.04.024	Tassello plastico frontale	Front grid (plastic)	Vorderer plastikdübel	Cheville plastique frontale	Taco plástico frontal
6	01.05.027	Pannello plastico posteriore	Rear panel (plastic)	Hinteres plastikpaneel	Panneau plastique arrière	Panel plástico posterior
7	74.90.028	Kit manico	Handle - Spare kit	Kit griffhal	Kit manche	Kit mango
8	19.06.008	Attacco centralizzato	Central adaptor system	Zentralanschluss für brenner	Raccord centralisé	Conector centralizado
9	20.07.165	Protezione mozzo	Cover	Schutz	Protection	Protección
10	01.14.053	Supporto fascio cavi	Holder / support	Halterung	Support	Soporte
11	03.05.04801	Targa frontale	Front nameplate	Vorderschild	Plaque frontale	Placa frontal
12	10.13.054	Spina fissa 70mm²	Current plug (panel) 70mm²	Fester stecker 70mm²	Fiche fixe 70 mm²	Toma eléctrica 70mm²
13	20.02.003	Aspo porta rocchetto 15kg	Wire spool spindle (15kg)	Drahtspulenshaspel 15kg	Support bobine 15 kgs	Husillo bobina (15kg)
14	15.14.4826	Scheda elettronica	P.C. Board	Elektronische platine	Platine électronique	Tarjeta electrónica
15	15.22.353	Pannello comandi FP353	Control panel FP353	Bedienungsfeld FP353	Panneau commandes FP353	Panel mandos FP353
16	07.01.099	Motoriduttore 225RPM	Geared motor (225RPM)	Getriebemotor 225RPM	Motoréducteur 225RPM	Motorreductor 225RPM
17	09.05.001	Elettrovalvola	Solenoid valve	Magnetventil	Électrovanne	Electroválvula
*	49.07.489	Cablaggio	Wiring	Verdrahtung	Câblage	Cableado
*	49.07.397	Cablaggio	Wiring	Verdrahtung	Câblage	Cableado
*	49.07.486	Cablaggio	Wiring	Verdrahtung	Câblage	Cableado
18	19.50.053	Innesto rapido acqua 1/8" blu	Quick connector h2o (blue) - 1/8"	Wasserschnellanschluss 1/8" blau	Raccord rapide eau 1/8" bleu	Conexión rápida agua 1/8" azul
19	19.50.054	Innesto rapido acqua 1/8" rosso	Quick connector h2o (red) - 1/8"	Wasserschnellanschluss 1/8" rot	Raccord rapide eau 1/8" rouge	Conexión rápida agua 1/8" rojo
20	19.01.036	Cannetta - 86mm	Insulated liner - 86mm	Drahtführung - 86mm	Tuyau en plastique - 86mm	Tubo guía hilo - 86mm
21	19.50.058	Dado 1/8 gas - 1/8 gas	Nut-1/8" 1/8" gas fitting	Mutter 1/8 gasgewinde - 1/8 gasgewinde	Écrou 1/8 gaz - 1/8 gaz	Tuerca 1/8 gas - 1/8 gas
22	24.01.005	Raccordo 6 - 1/8" 90°	Fitting 6 - 1/8" 90°	Anschluss 6 - 1/8" 90°	Raccord. 6 - 1/8" 90°	Racor 6 - 1/8" 90°
23	19.50.044	Dado portagomma 1/8"	Gas hose holder 1/8"	Schlauchhaltermutter 1/8"	Écrou porte tuyau 1/8"	Tuerca boquilla 1/8"
24	20.07.093	Isolatore gas-potenza	Gas-power insulating	Gas-leistungsisolator	Isolateur gaz-puissance	Aislador gas-potencia
25	20.04.157	Cerniera a scatto	Snap hinge	Scharnier	Charniere	Bisagra
26	20.04.080	Chiavistello	Rotary lock key	Riegel	Verrou	Cerrojo
27	24.01.001	Raccordo 6 - 1/8"	Fitting 6 - 1/8"	Anschluss 6 - 1/8"	Raccord. 6 - 1/8"	Racor 6 - 1/8"

POS.	CODE	ITALIANO	ENGLISH	DEUTSCH	FRANÇAIS	ESPAÑOL
28	24.01.190	Raccordo 1/8" - 1/4"	Fitting 1/8" - 1/4"	Anschluss 1/8" - 1/4"	Raccord. 1/8" - 1/4"	Racor 1/8" - 1/4"
29	09.04.402	Pulsante	Push button	Drucktaste	Bouton	Pulsador
30	10.01.024	Connettore 10 contatti maschio	10 pins connector - male	10-polige Kupplungstecker (male)	Connecteur 10 contacts mâle	Conector 10 polos macho
31	08.20.00501	Gommino passacavo	Passthrough gasket	Gummidichtung für Kabeldurchführung	Joint passe-câble	Goma pasahilo
32	20.04.021	Tappo	Cap	Stopfen	Bouchon	Tapón
*	21.04.002	Tubo PVC retinato 6x12	Braided PVC hose - 6x12	Pvc-gewebeschlauch 6x12	Tuyau PVC avec gaine de protection 6x12	Manguera PVC con malla 6x12
33	07.01.337	Gruppo traino 4 rulli (4 rulli trainanti)	Feed unit - 4 rools	Drahtvorschub, 4 rollen	Groupe chariot 4 rouleaux	Grupo alimentación alambre 4 rodillos
34	07.01.323	Dado guidafilo	Wire guide nut	Drahtführungsmutter	Écrou guide-fil	Tuerca guía del alambre
	91.08.426	Manuale istruzioni: WF NX 430 [IT, EN, DE, FR, ES, PT, NL, SV, DA, NO, FI, E]	Instruction manual: WF NX 430 [IT, EN, DE, FR, ES, PT, NL, SV, DA, NO, FI, E]	Bedienungsanweisungen: WF NX 430 [IT, EN, DE, FR, ES, PT, NL, SV, DA, NO, FI, E]	Manuel d'instructions: WF NX 430 [IT, EN, DE, FR, ES, PT, NL, SV, DA, NO, FI, E]	Manual instrucciones: WF NX 430 [IT, EN, DE, FR, ES, PT, NL, SV, DA, NO, FI, E]
	91.08.427	Manuale istruzioni: WF NX 430 [CS, PL, RU, TR, RO, BG, SK, ET, LV, LT, HU, S]	Instruction manual: WF NX 430 [CS, PL, RU, TR, RO, BG, SK, ET, LV, LT, HU, S]	Bedienungsanweisungen: WF NX 430 [CS, PL, RU, TR, RO, BG, SK, ET, LV, LT, HU, S]	Manuel d'instructions: WF NX 430 [CS, PL, RU, TR, RO, BG, SK, ET, LV, LT, HU, S]	Manual instrucciones: WF NX 430 [CS, PL, RU, TR, RO, BG, SK, ET, LV, LT, HU, S]

SL 4R-4T (07.01.337)

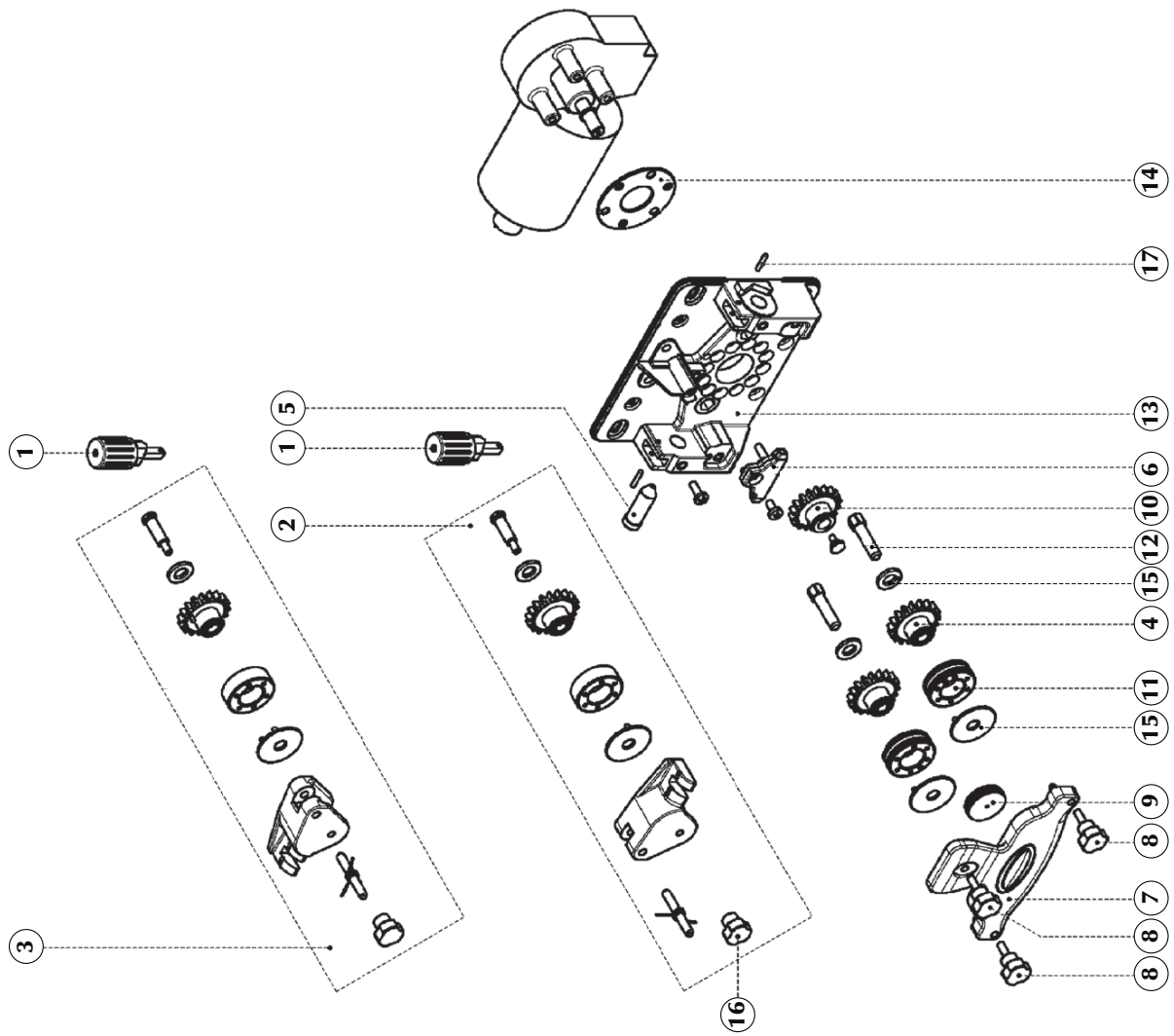

POS.	CODE	ITALIANO	ENGLISH	DEUTSCH	FRANÇAIS	ESPAÑOL
1	09.11.215	Manopola	Knob	Drehknopf	Bouton	Empuñadura
2	07.01.500	Gruppo pressore DX	Split wire guide - RIGHT	Druckkebel - RIGHT	Groupe presseur droit	Grupo prensador dcho.
3	07.01.501	Gruppo pressore SX	Split wire guide - LEFT	Druckkebel - LEFT	Groupe presseur gauche	Grupo prensador izqdo.
4	07.01.312	Ingranaggio trainafile	Feed unit - gear wheel	Zahnrad	Moteur devidoir complet	Engranaje alimentador de alambre
5	19.50.057	Raccordo ingresso filo	Wire input fitting	Anschluss drahteingang	Raccord entrée fil	Racor entrada alambre
6	20.07.053	Guida filo centrale 4 rulli	Central wire guide - 4 rolls feed unit	Zentrale drahtführung, 4 rollen	Guide fil central 4 galets	Guía hilo central 4 rodillos
7	20.07.047	Guida superiore 4 rulli	Rolls cover - 4 rolls feed unit	Obere führung, 4 rollen	Guide supérieure 4 galets	Guía superior 4 rodillos
8	20.04.058	Volantino maschio M5x15	Knob (male) - M5x15	Drehknopf M5x15, male	Volant mâle M5x15	Volante macho M5x15
9	20.07.079	Volantino	Knob	Drehknopf	Manette	Volante
10	07.01.309	Ingranaggio albero motore	Driving gear wheel	Motorwellenzahnrad	Moteur devidoir complet avec engrénage	Engranaje eje motor
11	07.01.292	Rullo trainafile D. 1,0-1,2mm filo pieno	Drive roll - smooth v groove - solid wire - D. 1,0-1,2mm	Drahtvorschubrolle D. 1,0-1,2mm massivdraht	Galet D. 1,0-1,2mm - gorge env - fil plein	Rodillo alimentador de alambre D. 1,0-1,2mm alambre sólido
12	18.76.012	Perno esagonale ingr. condotti	Hexagonal pin	Sechskantzapfen eing. leitungen	Goujon hexagonal entr. conduits	Perno hexagonal engr. conducidos
13	20.07.046	Corpo traino 4 rulli	Motor plate - 4 rolls feed unit	Grundplatte für drahtvorschub, 4 rollen	Corps charriot 4 galets	Cuerpo alimentación alambre 4 rodillos
14	20.07.052	Flangia motore	Motor flange	Motorflansch	Bride moteur	Brida motor
15	20.07.085	Kit rondelle traino 4 rulli	Feed unit washer - Spare kit	Kit unterlegscheiben	Kit rondelles devidoir 4 galets	Kit arandelas unidad alimentación 4 rodillos
16	20.04.059	Volantino femmina M5	Knob (female) - M5	Drehknopf M5, female	Volant femelle M5	Volante hembra M5
17	18.03.025	Vite M5x10	Screw M5x10	Schraube M5x10	Vis M5x10	Tornillo M5x10
18	18.03.088	Vite M4x14	Screw M4x14	Schraube M4x14	Vis M4x14	Tornillo M4x14
19	18.77.006	Spina	Pin	Stift	Goupille	Tapon
*	18.02.002	Grano	Hexagon socket set screw	Stift	Vis sans tête	Tornillo sin cabeza

17. INSTALLAZIONE KIT/ACCESSORI, INSTALLATION KIT/ACCESSORIES, INSTALLATION KITS/
 ZUBEHÖR, INSTALLATION KIT/ACCESSOIRES, INSTALACIÓN KIT/ACCESORIOS, INSTALAÇÃO
 KIT/ACESSÓRIOS, HET INSTALLEREN KIT/ACCESSOIRES, INSTALLATION KIT/TILLBEHÖR,
 INSTALLERING KIT/EKSTRAUDSTYR, INSTALLASJON KIT/TILBEHØRSSETT, ASENNUS KIT/
 LISÄVARUSTEET, ΕΓΚΑΤΑΣΤΑΣΗ ΚΙΤ/ ΑΞΕΣΟΥΑΡ

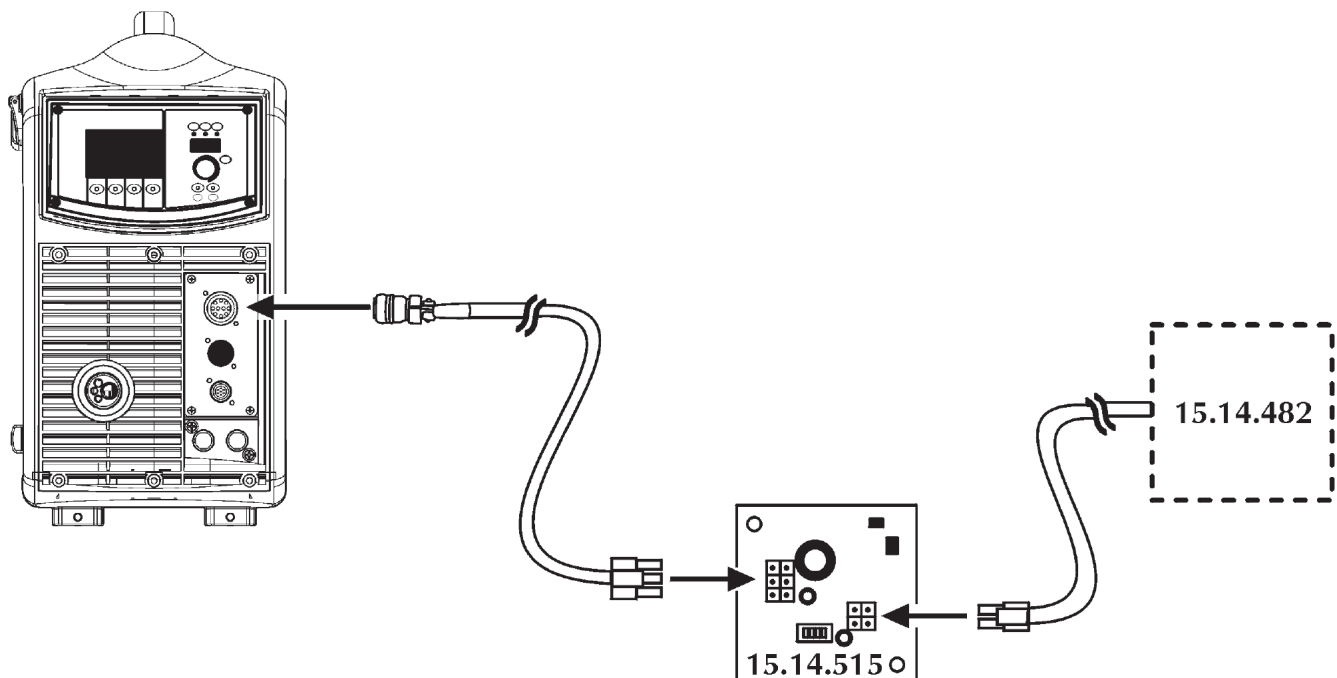
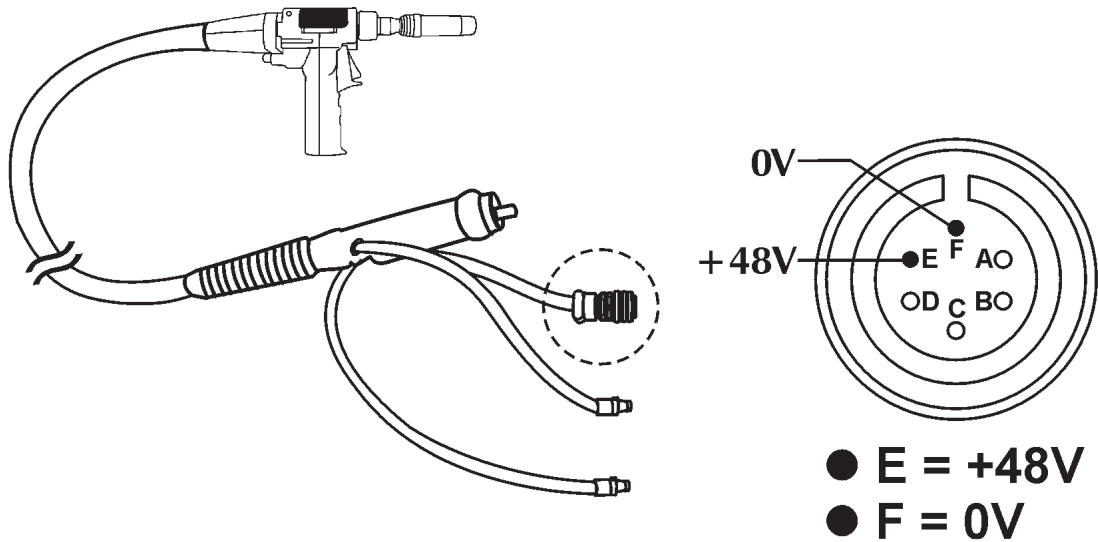

73.11.012 Kit Push-Pull

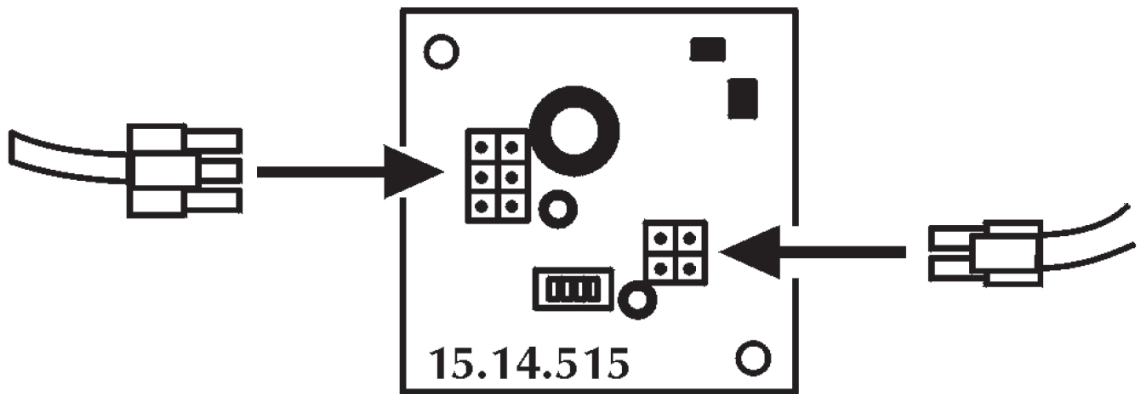
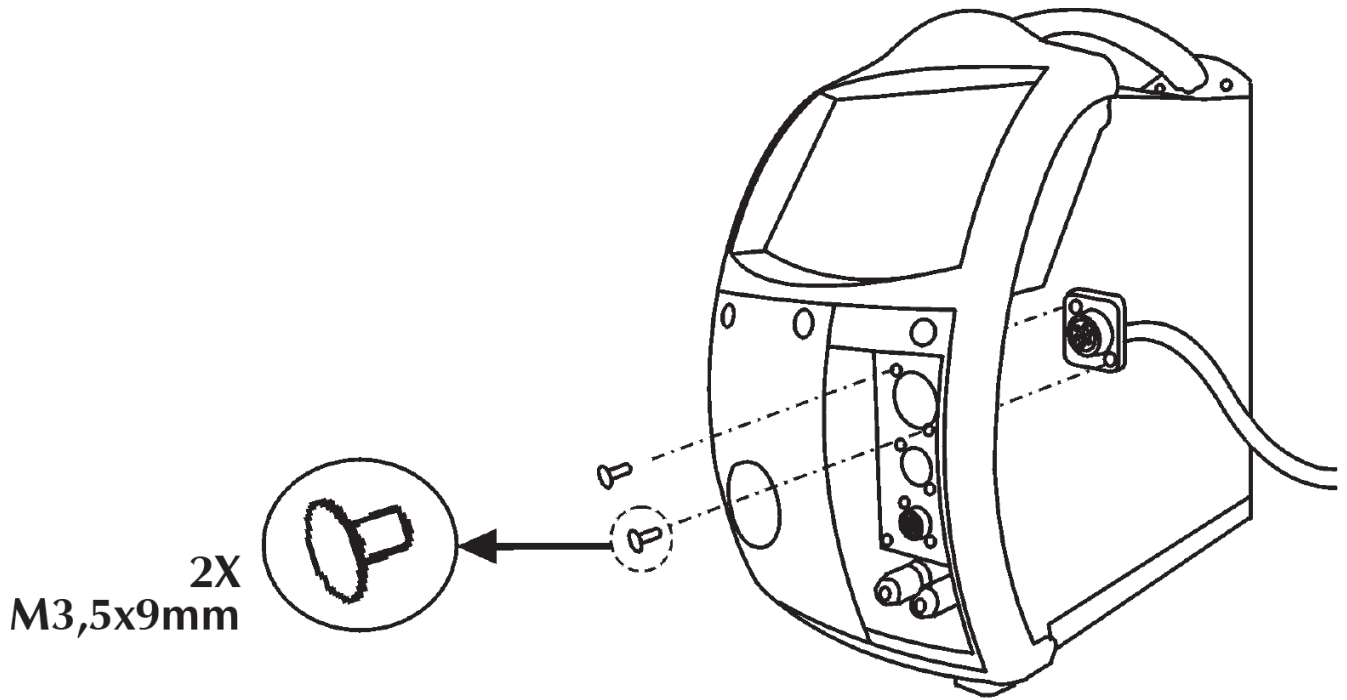

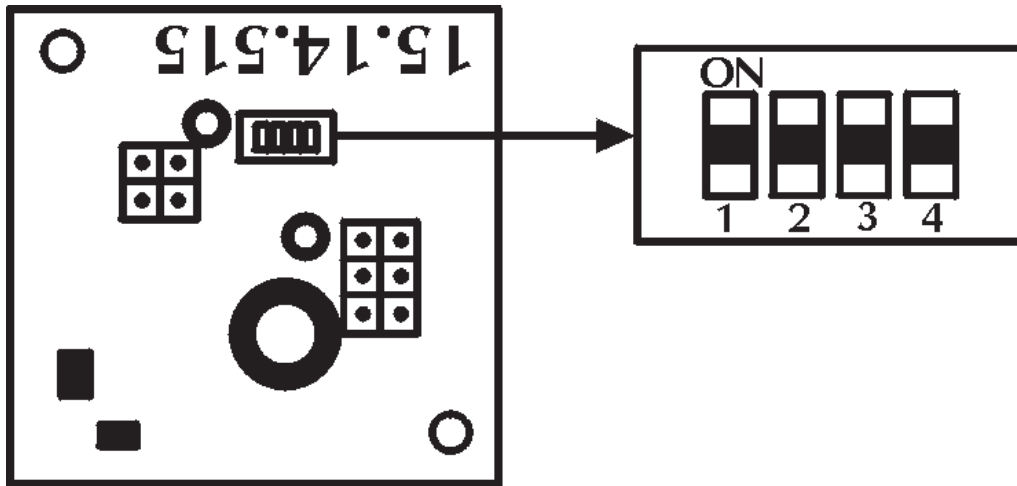

Selezione potenza Push-Pull, Push-Pull power setting, Push Pull Leistung Auswahl, Sélection de puissance Push-Pull, Selección de Push-Pull potencia, Definição de potência "push-pull", Definição de potência "push-pull", Selectie vermogen Push-Pull, Push-Pull driftsinställningar, Valg af Push-Pull-effekt, Push-Pull-tehon valinta, Επιλογή ισχύος Push-Pull

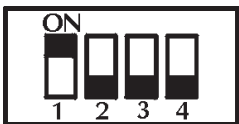

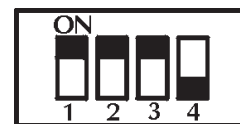
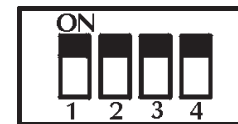
Minimum	Medium	Medium	Maximum
			
1 ON 2 OFF 3 OFF 4 OFF	1 ON 2 ON 3 OFF 4 OFF	1 ON 2 ON 3 ON 4 OFF	1 ON 2 ON 3 ON 4 ON

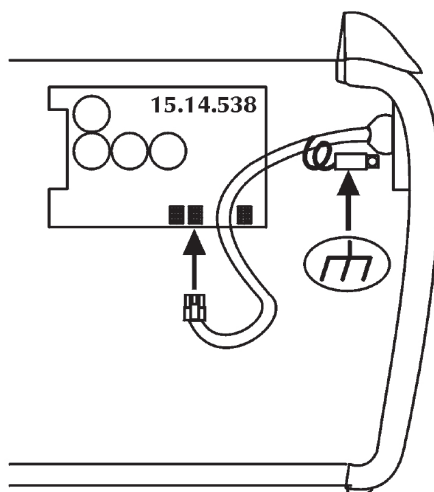
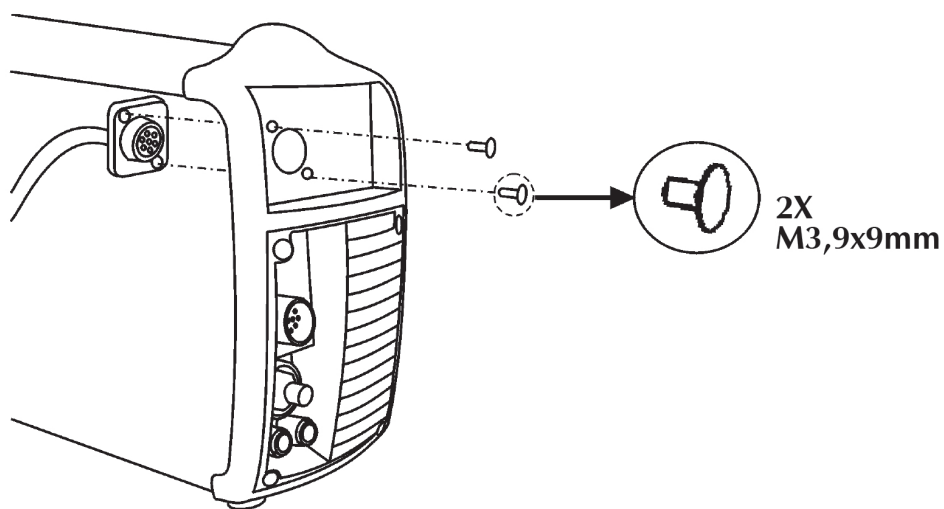
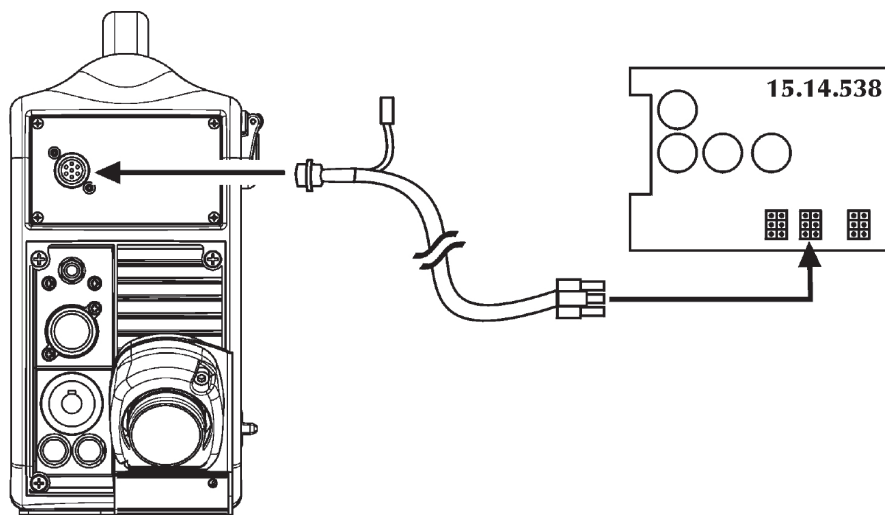

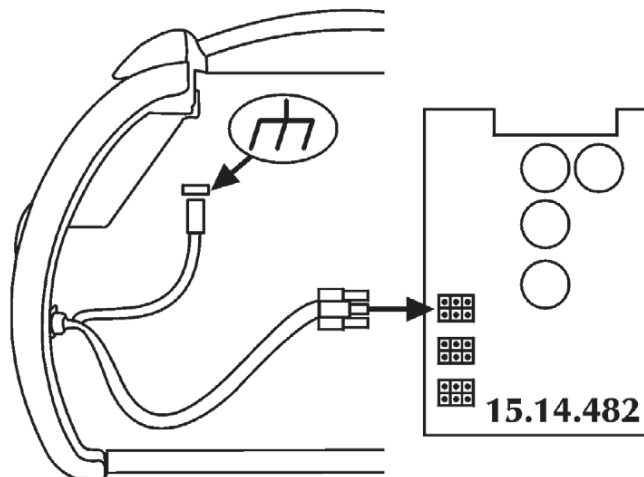
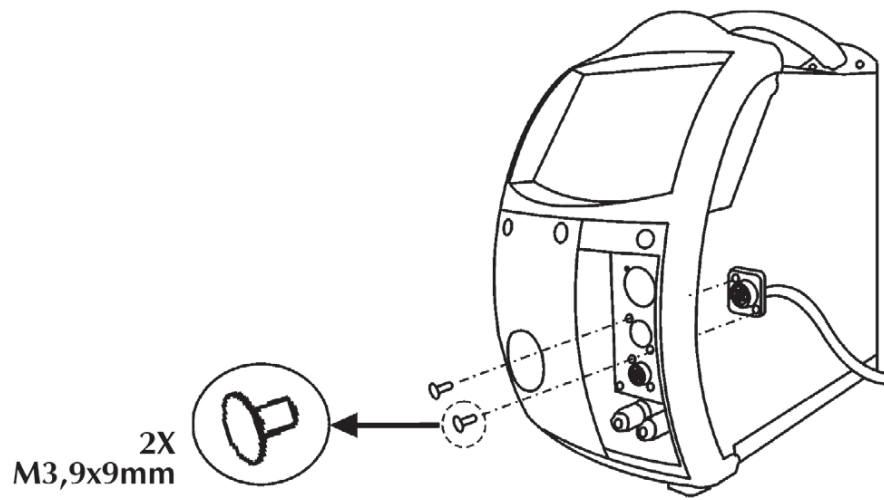
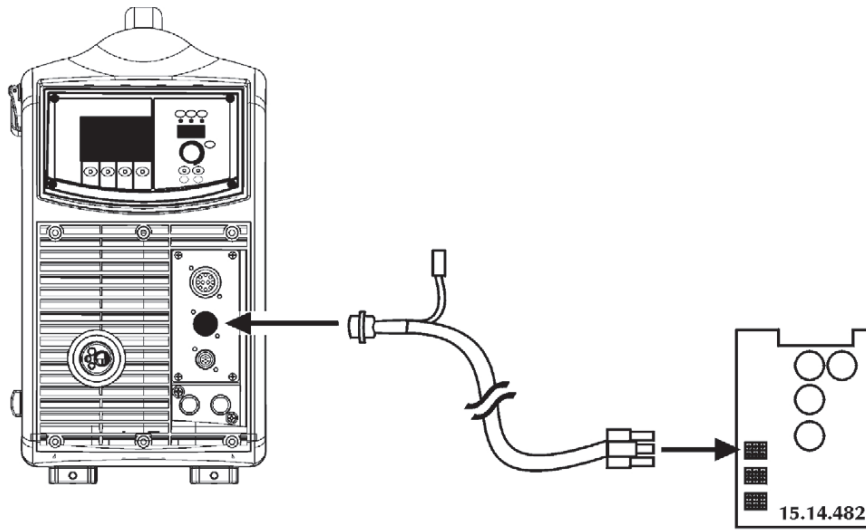

73.10.073 Feed unit big wheels - upgrade kit

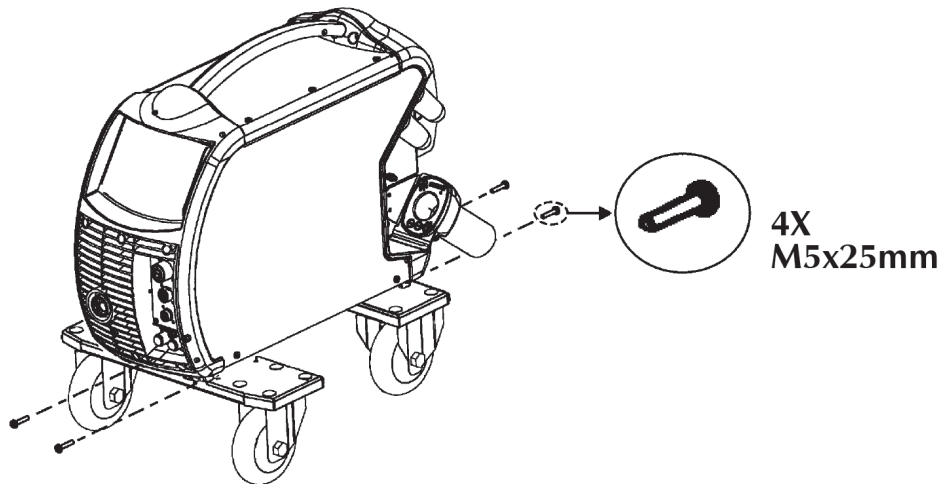
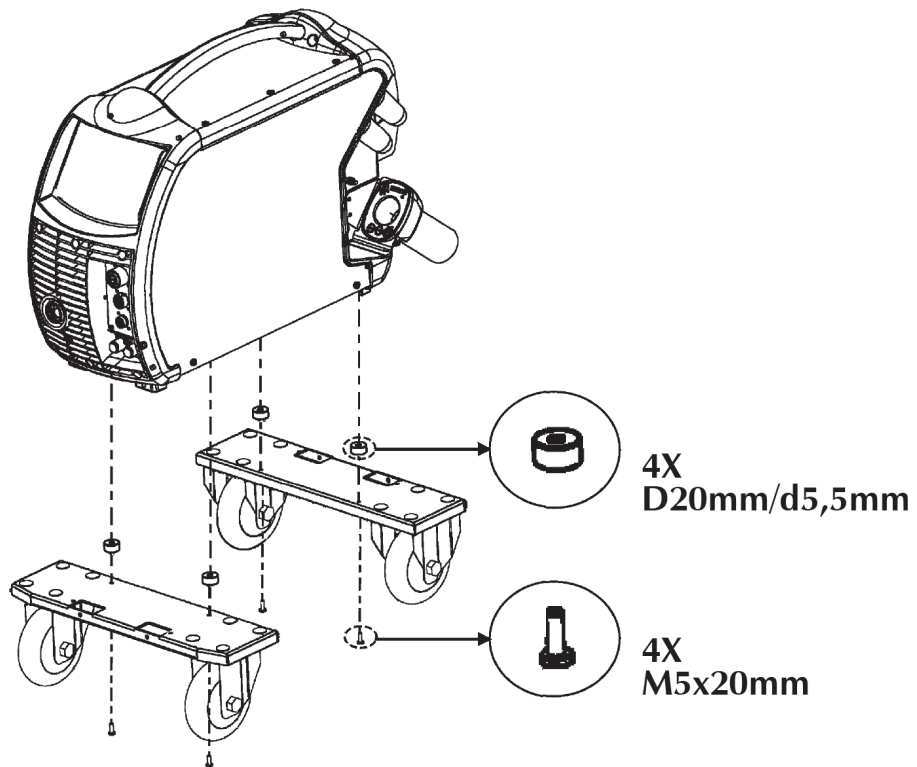
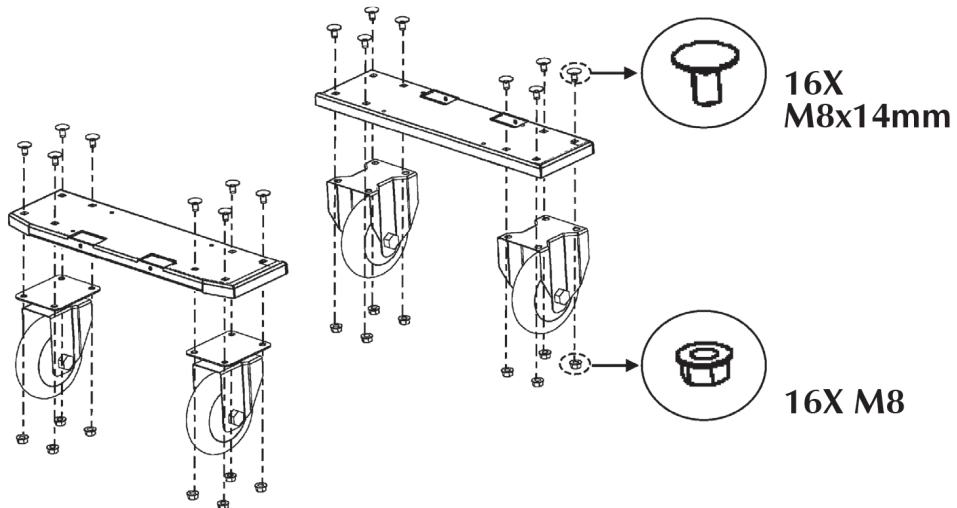

73.10.074 Feed unit little wheels - upgrade kit

