



böhlerwelding
by voestalpine

Lasting Connections

URANOS NX 3200 PME

INSTRUCTION MANUAL





Cod. 91.08.462
Date 15/10/2021
First edition

ITALIANO.....	1
ENGLISH	47
DEUTSCH.....	95
FRANÇAIS	141
ESPAÑOL.....	189
PORTUGUÊS	235
NEDERLANDS.....	281
SVENSKA	327
DANSK	373
NORSK	419
SUOMI	465
ΕΛΛΗΝΙΚΑ	511

IT

EN

DE

FR

ES

PT

NL

SV

DA

NO

FI

EL

DICHIARAZIONE DI CONFORMITÀ EU

Il costruttore

voestalpine Böhler Welding Selco S.r.l. - Via Palladio, 19 - 35019 Onara di Tombolo (PD) - ITALY
Tel. +39 049 9413/111 - Fax +39 049 9413/311 - www.voestalpine.com/welding

dichiara sotto la propria esclusiva responsabilità che il seguente prodotto:

URANOS NX 3200 PME	55.03.066
	55.03.070

è conforme alle direttive EU:

2014/35/EU LOW VOLTAGE DIRECTIVE

2014/30/EU EMC DIRECTIVE

2011/65/EU RoHS DIRECTIVE

e che sono state applicate le norme:

EN IEC 60974-1/A1:2019 WELDING POWER SOURCE

EN 60974-10/A1:2015 ELECTROMAGNETIC COMPATIBILITY REQUIREMENTS

La documentazione attestante la conformità alle direttive sarà tenuta a disposizione per ispezioni presso il sopracitato costruttore.

Ogni intervento o modifica non autorizzati dalla voestalpine Böhler Welding Selco S.r.l. faranno decadere la validità di questa dichiarazione.

Onara di Tombolo, 15/10/2021

voestalpine Böhler Welding Selco s.r.l.

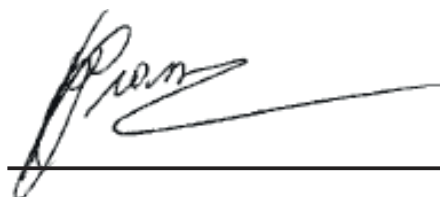

Lino Frasson

INDICE

1. AVVERTENZE.....	3
1.1 Ambiente di utilizzo	3
1.2 Protezione personale e di terzi	3
1.3 Protezione da fumi e gas	4
1.4 Prevenzione incendio/scoppio.....	4
1.5 Prevenzione nell'uso delle bombole di gas	5
1.6 Protezione da shock elettrico.....	5
1.7 Campi elettromagnetici ed interferenze.....	5
1.8 Grado di protezione IP	6
1.9 Smaltimento	6
2. INSTALLAZIONE	7
2.1 Modalità di sollevamento, trasporto e scarico.....	7
2.2 Posizionamento dell'impianto	7
2.3 Allacciamento	7
2.4 Messa in servizio	8
3. PRESENTAZIONE DELL'IMPIANTO.....	10
3.1 Pannello posteriore.....	10
3.2 Pannello prese.....	10
3.3 Pannello comandi frontale.....	10
3.4 Pannello comandi frontale.....	11
4. UTILIZZO DELL'IMPIANTO.....	12
4.1 Schermata di avvio.....	12
4.2 Schermata di test	12
4.3 Schermata principale.....	13
4.4 Schermata principale processo MMA.....	13
5. SETUP.....	20
5.1 Set up e impostazione dei parametri	20
5.2 Procedure specifiche di utilizzo dei parametri	29
6. MANUTENZIONE.....	34
6.1 Controlli periodici	34
6.2 Responsabilità.....	34
7. CODIFICA ALLARMI	34
8. DIAGNOSTICA E SOLUZIONI	36
9. CENNI TEORICI SULLA SALDATURA.....	40
9.1 Saldatura con elettrodo rivestito (MMA).....	40
9.2 Saldatura TIG (arco continuo).....	41
9.3 Saldatura a filo continuo (MIG/MAG)	42
10. CARATTERISTICHE TECNICHE	45
11. TARGA DATI.....	46
12. SIGNIFICATO TARGA DATI	46
13. SCHEMA.....	557
14. CONNETTORI	559
15. LISTA RICAMBI.....	560

SIMBOLOGIA



Pericoli imminenti che causano gravi lesioni e comportamenti rischiosi che potrebbero causare gravi lesioni.



Comportamenti che potrebbero causare lesioni non gravi o danni alle cose.



Le note precedute da questo simbolo sono di carattere tecnico e facilitano le operazioni.

1. AVVERTENZE



Prima di iniziare qualsiasi operazione siate sicuri di aver ben letto e compreso questo manuale. Non apportate modifiche e non eseguite manutenzioni non descritte. Il produttore non si fa carico di danni a persone o cose, occorsi per incuria nella lettura o nella messa in pratica di quanto scritto in questo manuale. Conservare sempre le istruzioni per l'uso sul luogo d'impiego dell'apparecchio. Oltre alle istruzioni per l'uso, attenersi alle norme generali e ai regolamenti locali vigenti in materia di prevenzione degli incidenti e tutela dell'ambiente.



Tutte le persone addette alla messa in funzione, all'utilizzo, alla manutenzione e alla riparazione dell'apparecchio devono

- essere in possesso di apposita qualifica
- disporre delle competenze necessarie in materia di saldatura
- leggere integralmente e osservare scrupolosamente le presenti istruzioni per l'uso.

Per ogni dubbio o problema circa l'utilizzo dell'impianto, anche se qui non descritto, consultare personale qualificato.

1.1 Ambiente di utilizzo



Ogni impianto deve essere utilizzato esclusivamente per le operazioni per cui è stato progettato, nei modi e nei campi previsti in targa dati e/o in questo manuale, secondo le direttive nazionali e internazionali relative alla sicurezza. Un utilizzo diverso da quello espressamente dichiarato dal costruttore è da considerarsi totalmente inappropriato e pericoloso e in tal caso il costruttore declina ogni responsabilità.



Questo apparecchio deve essere usato solo a scopo professionale in un ambiente industriale. Il costruttore non risponderà di danni provocati dall'uso dell'impianto in ambienti domestici.



L'impianto deve essere utilizzato in ambienti con temperatura compresa tra i -10°C e i +40°C (tra i +14°F e i +104°F). L'impianto deve essere trasportato e immagazzinato in ambienti con temperatura compresa tra i -25°C e i +55°C (tra i -13°F e i 131°F).

L'impianto deve essere utilizzato in ambienti privi di polvere, acidi, gas o altre sostanze corrosive.

L'impianto deve essere utilizzato in ambienti con umidità relativa non superiore al 50% a 40°C (104°F).

L'impianto deve essere utilizzato in ambienti con umidità relativa non superiore al 90% a 20°C (68°F).

L'impianto deve essere utilizzato ad una altitudine massima sul livello del mare di 2000m (6500 piedi).



Non utilizzare tale apparecchiatura per scongelare tubi.

Non utilizzare tale apparecchiatura per caricare batterie e/o accumulatori.

Non utilizzare tale apparecchiatura per far partire motori.

1.2 Protezione personale e di terzi



Il processo di saldatura è fonte nociva di radiazioni, rumore, calore ed esalazioni gassose. Sistemare una parete divisoria ignifuga per proteggere la zona di saldatura da raggi, scintille e scorie incandescenti. Avvertire le eventuali terze persone di non fissare con lo sguardo la saldatura e di proteggersi dai raggi dell'arco e dal metallo incandescente.



Indossare indumenti di protezione per proteggere la pelle dai raggi dell'arco e dalle scintille o dal metallo incandescente. Gli indumenti utilizzati devono coprire tutto il corpo e devono essere:

- integri e in buono stato
- ignifughi
- isolanti e asciutti
- aderenti al corpo e privi di risvolti



Utilizzare sempre calzature a normativa, resistenti e in grado di garantire l'isolamento dall'acqua.

Utilizzare sempre guanti a normativa, in grado di garantire l'isolamento elettrico e termico.



Utilizzare maschere con protezioni laterali per il viso e filtro di protezione idoneo (almeno NR10 o maggiore) per gli occhi.



Indossare sempre occhiali di sicurezza con schermi laterali specialmente nell'operazione manuale o meccanica di rimozione delle scorie di saldatura.



Non utilizzare lenti a contatto!



Utilizzare cuffie antirumore se il processo di saldatura diviene fonte di rumorosità pericolosa. Se il livello di rumorosità supera i limiti di legge, delimitare la zona di lavoro ed accertarsi che le persone che vi accedono siano protette con cuffie o auricolari.



Tenere sempre i pannelli laterali chiusi durante le operazioni di saldatura. Evitare il contatto tra mani, capelli, indumenti, attrezzi... e parti in movimento quali: ventilatori, ruote dentate, rulli e alberi, bobine di filo. Non operare sulle ruote dentate quando il trainafilo è in funzione. L'impianto non deve essere sottoposto ad alcun tipo di modifica. L'esclusione dei dispositivi di protezione sulle unità di avanzamento del filo è estremamente pericoloso e solleva il costruttore da ogni responsabilità su danni a cose e persone.



Tenere la testa lontano dalla torcia MIG/MAG durante il caricamento e l'avanzamento del filo. Il filo in uscita può provocare seri danni alle mani, al viso e agli occhi.



Evitare di toccare i pezzi appena saldati, l'elevato calore potrebbe causare gravi ustioni o scottature. Mantenere tutte le precauzioni precedentemente descritte anche nelle lavorazioni post saldatura in quanto, dai pezzi lavorati che si stanno raffreddando, potrebbero staccarsi scorie.



Assicurarsi che la torcia si sia raffreddata prima di eseguire lavorazioni o manutenzioni.



Assicurarsi che il gruppo di raffreddamento sia spento prima di sconnettere i tubi di mandata e ritorno del liquido refrigerante. Il liquido caldo in uscita potrebbe causare gravi ustioni o scottature.



Provvedere ad un'attrezzatura di pronto soccorso. Non sottovalutare scottature o ferite.



Prima di lasciare il posto di lavoro, porre in sicurezza l'area di competenza in modo da impedire danni accidentali a cose o persone.

1.3 Protezione da fumi e gas



Fumi, gas e polveri prodotti dal processo di saldatura possono risultare dannosi alla salute. I fumi prodotti durante il processo di saldatura possono, in determinate circostanze, provocare il cancro o danni al feto nelle donne in gravidanza.

- Tenere la testa lontana dai gas e dai fumi di saldatura.
- Prevedere una ventilazione adeguata, naturale o forzata, nella zona di lavoro.
- In caso di aerazione insufficiente utilizzare maschere dotate di respiratori.
- Nel caso di saldature in ambienti angusti è consigliata la sorveglianza dell'operatore da parte di un collega situato esternamente.
- Non usare ossigeno per la ventilazione.
- Verificare l'efficacia dell'aspirazione controllando periodicamente l'entità delle emissioni di gas nocivi con i valori ammessi dalle norme di sicurezza.
- La quantità e la pericolosità dei fumi prodotti è riconducibile al materiale base utilizzato, al materiale d'apporto e alle eventuali sostanze utilizzate per la pulizia e lo sgrassaggio dei pezzi da saldare. Seguire attentamente le indicazioni del costruttore e le relative schede tecniche.
- Non eseguire operazioni di saldatura nei pressi di luoghi di sgrassaggio o verniciatura.
- Posizionare le bombole di gas in spazi aperti o con un buon ricircolo d'aria.

1.4 Prevenzione incendio/scoppio



Il processo di saldatura può essere causa di incendio e/o scoppio.

- Sgomberare dalla zona di lavoro e circostante i materiali o gli oggetti infiammabili o combustibili.
- I materiali infiammabili devono trovarsi ad almeno 11 metri (35 piedi) dalla zona di lavoro o devono essere opportunamente protetti.
- Le proiezioni di scintille e di particelle incandescenti possono facilmente raggiungere le zone circostanti anche attraverso piccole aperture. Porre particolare attenzione nella messa in sicurezza di cose e persone.
- Non eseguire saldature sopra o in prossimità di recipienti in pressione.
- Non eseguire operazioni di saldatura su recipienti o tubi chiusi. Porre comunque particolare attenzione nella saldatura di tubi o recipienti anche nel caso questi siano stati aperti, svuotati e accuratamente puliti. Residui di gas, carburante, olio o simili potrebbe causare esplosioni.
- Non saldare in atmosfera contenente polveri, gas o vapori esplosivi.
- Accertarsi, a fine lavoro, che il circuito in tensione non possa accidentalmente toccare parti collegate al circuito di massa.
- Predisporre nelle vicinanze della zona di lavoro un'attrezzatura o un dispositivo antincendio.

1.5 Prevenzione nell'uso delle bombole di gas



Le bombole di gas inerte contengono gas sotto pressione e possono esplodere nel caso non vengano assicurate le condizioni minime di trasporto, mantenimento e uso.

- Le bombole devono essere vincolate verticalmente a pareti o ad altro, con mezzi idonei, per evitare cadute o urti meccanici accidentali.
- Avvitare il cappuccio a protezione della valvola durante il trasporto, la messa in servizio e ogni qualvolta le operazioni di saldatura siano terminate.
- Evitare che le bombole siano esposte direttamente ai raggi solari e a sbalzi elevati di temperatura. Non esporre le bombole a temperature troppo rigide o troppo alte.
- Evitare che le bombole entrino in contatto con fiamme libere, con archi elettrici, con torce o pinze porta elettrodo, con le proiezioni incandescenti prodotte dalla saldatura.
- Tenere le bombole lontano dai circuiti di saldatura e dai circuiti di corrente in genere.
- Tenere la testa lontano dal punto di fuoriuscita del gas quando si apre la valvola della bombola.
- Chiudere sempre la valvola della bombola quando le operazioni di saldatura sono terminate.
- Non eseguire mai saldature su una bombola di gas in pressione.
- Non collegare mai una bombola di aria compressa direttamente al riduttore della macchina! La pressione potrebbe superare la capacità del riduttore che quindi potrebbe esplodere!

1.6 Protezione da shock elettrico



Uno shock da scarica elettrica può essere mortale.

- Evitare di toccare parti normalmente in tensione interne o esterne all'impianto di saldatura mentre l'impianto stesso è alimentato (torce, pinze, cavi massa, elettrodi, fili, rulli e bobine sono elettricamente collegati al circuito di saldatura).
- Assicurare l'isolamento elettrico dell'impianto e dell'operatore utilizzando piani e basamenti asciutti e sufficientemente isolati dal potenziale di terra e di massa.
- Assicurarsi che l'impianto venga allacciato correttamente ad una spina e ad una rete provvista del conduttore di protezione a terra.
- Non toccare contemporaneamente due torce o due pinze portaelettrodo.
- Interrompere immediatamente le operazioni di saldatura se si avverte la sensazione di scossa elettrica.

1.7 Campi elettromagnetici ed interferenze



Il passaggio della corrente attraverso i cavi interni ed esterni all'impianto, crea un campo elettromagnetico nelle immediate vicinanze dei cavi e dell'impianto stesso.

- I campi elettromagnetici possono avere effetti (ad oggi sconosciuti) sulla salute di chi ne subisce una esposizione prolungata.
- I campi elettromagnetici possono interferire con altre apparecchiature quali pace-maker o apparecchi acustici.



I portatori di apparecchiature elettroniche vitali (pace-maker) devono consultare il medico prima di avvicinarsi alle operazioni di saldatura ad arco.

1.7.1 Classificazione EMC in accordo con la norma: EN 60974-10/A1:2015.

Classe
B

L'apparecchiatura di Classe B è conforme con i requisiti di compatibilità elettromagnetica in ambienti industriali e residenziali, incluse aree residenziali dove l'energia elettrica è fornita da un sistema pubblico a bassa tensione.

Classe
A

L'apparecchiatura di Classe A non è intesa per l'uso in aree residenziali dove l'energia elettrica è fornita da un sistema pubblico a bassa tensione. Può essere potenzialmente difficile assicurare la compatibilità elettromagnetica di apparecchiature di classe A in questi aree, a causa di disturbi irradiati e condotti.

Per maggiori informazioni consultare: TARGA DATI o CARATTERISTICHE TECNICHE.

1.7.2 Installazione, uso e valutazione dell'area

Questo apparecchio è costruito in conformità alle indicazioni contenute nella norma armonizzata: EN 60974-10/A1:2015 ed è identificato come di "CLASSE A". Questo apparecchio deve essere usato solo a scopo professionale in un ambiente industriale. Il costruttore non risponderà di danni provocati dall'uso dell'impianto in ambienti domestici.



L'utilizzatore deve essere un esperto del settore ed in quanto tale è responsabile dell'installazione e dell'uso dell'apparecchio secondo le indicazioni del costruttore. Qualora vengano rilevati dei disturbi elettromagnetici, spetta all'utilizzatore dell'apparecchio risolvere la situazione avvalendosi dell'assistenza tecnica del costruttore.



In tutti i casi i disturbi elettromagnetici devono essere ridotti fino al punto in cui non costituiscono più un fastidio.



Prima di installare questo apparecchio, l'utilizzatore deve valutare i potenziali problemi elettromagnetici che si potrebbero verificare nell'area circostante e in particolare la salute delle persone circostanti, per esempio: utilizzatori di pace-maker e di apparecchi acustici.

1.7.3 Requisiti alimentazione di rete

Apparecchiature ad elevata potenza possono influenzare la qualità dell'energia della rete di distribuzione a causa della corrente assorbita. Conseguentemente, alcune restrizioni di connessione o alcuni requisiti riguardanti la massima impedenza di rete ammessa (Z_{max}) o la minima potenza d'installazione (Ssc) disponibile al punto di interfaccia con la rete pubblica (punto di accoppiamento comune - Point of Common Coupling PCC) possono essere applicati per alcuni tipi di apparecchiature (vedi dati tecnici). In questo caso è responsabilità dell'installatore o dell'utilizzatore assicurarsi, con la consultazione del gestore della rete se necessario, che l'apparecchiatura possa essere connessa. In caso di interferenza potrebbe essere necessario prendere ulteriori precauzioni quali il filtraggio dell'alimentazione di rete.

Si deve inoltre considerare la possibilità di schermare il cavo d'alimentazione.

Per maggiori informazioni consultare: CARATTERISTICHE TECNICHE.

1.7.4 Precauzioni riguardo i cavi

Per minimizzare gli effetti dei campi elettromagnetici, seguire le seguenti regole:

- Arrotolare insieme e fissare, dove possibile, cavo massa e cavo potenza.
- Evitare di arrotolare i cavi intorno al corpo.
- Evitare di frapporti tra il cavo di massa e il cavo di potenza (tenere entrambi dallo stesso lato).
- I cavi devono essere tenuti più corti possibile e devono essere posizionati vicini e scorrere su o vicino il livello del suolo.
- Posizionare l'impianto ad una certa distanza dalla zona di lavoro.
- I cavi devono essere posizionati lontano da eventuali altri cavi presenti.

1.7.5 Collegamento equipotenziale

Il collegamento a massa di tutti i componenti metallici nell'impianto di saldatura e nelle sue vicinanze deve essere preso in considerazione. Rispettare le normative nazionali riguardanti il collegamento equipotenziale.

1.7.6 Messa a terra del pezzo in lavorazione

Dove il pezzo in lavorazione non è collegato a terra, per motivi di sicurezza elettrica o a causa della dimensione e posizione, un collegamento a massa tra il pezzo e la terra potrebbe ridurre le emissioni. Bisogna prestare attenzione affinché la messa a terra del pezzo in lavorazione non aumenti il rischio di infortunio degli utilizzatori o danneggi altri apparecchi elettrici. Rispettare le normative nazionali riguardanti la messa a terra.

1.7.7 Schermatura

La schermatura selettiva di altri cavi e apparecchi presenti nell'area circostante può alleviare i problemi di interferenza.

La schermatura dell'intero impianto di saldatura può essere presa in considerazione per applicazioni speciali.

1.8 Grado di protezione IP



IP23S

- Involucro protetto contro l'accesso a parti pericolose con un dito e contro corpi solidi estranei di diametro maggiore o uguale a 12,5 mm.
- Involucro protetto contro pioggia a 60° sulla verticale.
- Involucro protetto dagli effetti dannosi dovuti all'ingresso d'acqua, quando le parti mobili dell'apparecchiatura non sono in moto.

1.9 Smaltimento



Non collocare l'apparecchiatura elettrica tra i normali rifiuti!

In osservanza alla Direttiva Europea 2012/19/EU sui Rifiuti di Apparecchiature Elettriche ed Elettroniche e alla sua implementazione in accordo con le leggi nazionali, le apparecchiature elettriche che hanno raggiunto la fine del ciclo di vita devono essere raccolte separatamente e inviate ad un centro di recupero e smaltimento. Il proprietario dell'apparecchiatura dovrà identificare i centri di raccolta autorizzati informandosi presso le Amministrazioni Locali. L'applicazione della Direttiva Europea permetterà di migliorare l'ambiente e la salute umana.

2. INSTALLAZIONE



L'installazione può essere effettuata solo da personale esperto ed abilitato dal produttore.



Per l'installazione assicurarsi che il generatore sia scollegato dalla rete di alimentazione.



È vietata la connessione (in serie o parallelo) dei generatori.

2.1 Modalità di sollevamento, trasporto e scarico

- L'impianto è provvisto di un manico che ne permette la movimentazione a mano.
- L'impianto non è provvisto di elementi specifici per il sollevamento.
- Utilizzare un elevatore a forche ponendo la massima attenzione nello spostamento, al fine di evitare il ribaltamento del generatore.



Non sottovalutare il peso dell'impianto, vedi caratteristiche tecniche.
Non far transitare o sostare il carico sospeso sopra a persone o cose.
Non lasciare cadere o appoggiare con forza l'impianto o la singola unità.

2.2 Posizionamento dell'impianto



Osservare le seguenti norme:

- Facile accesso ai comandi ed ai collegamenti.
- Non posizionare l'attrezzatura in ambienti angusti.
- Non posizionare mai l'impianto su di un piano con inclinazione maggiore di 10° dal piano orizzontale.
- Collocare l'impianto in un luogo asciutto, pulito e con ventilazione appropriata.
- Proteggere l'impianto contro la pioggia battente e contro il sole.

2.3 Allacciamento



Il generatore è provvisto di un cavo di alimentazione per l'allacciamento alla rete.
L'impianto può essere alimentato con:

- 400V trifase
- 230V trifase

Il funzionamento dell'apparecchiatura è garantito per tensioni che si discostano fino al $\pm 15\%$ dal valore nominale.



Per evitare danni alle persone o all'impianto, occorre controllare la tensione di rete selezionata e i fusibili PRIMA di collegare la macchina alla rete. Inoltre occorre assicurarsi che il cavo venga collegato a una presa fornita di contatto di terra.



È possibile alimentare l'impianto attraverso un gruppo elettrogeno purché questo garantisca una tensione di alimentazione stabile tra il $\pm 15\%$ rispetto al valore di tensione nominale dichiarato dal costruttore, in tutte le condizioni operative possibili e alla massima potenza erogabile dal generatore. Di norma, si consiglia l'uso di gruppi elettrogeni di potenza pari a 2 volte la potenza del generatore se monofase e pari a 1.5 volte se trifase. Si consiglia l'uso di gruppi elettrogeni a controllo elettronico.



Per la protezione degli utenti, l'impianto deve essere correttamente collegato a terra. Il cavo di alimentazione è provvisto di un conduttore (giallo - verde) per la messa a terra, che deve essere collegato ad una spina dotata di contatto a terra. Questo filo giallo/verde non deve MAI essere usato insieme ad altro filo per prelievi di tensione. Controllare l'esistenza della "messa a terra" nell'impianto utilizzato ed il buono stato della presa di corrente. Montare solo spine omologate secondo le normative di sicurezza.



L'impianto elettrico deve essere realizzato da personale tecnico in possesso di requisiti tecnico-professionali specifici e in conformità alle leggi dello stato in cui si effettua l'installazione.

2.4 Messa in servizio

2.4.1 Collegamento per saldatura MMA



Il collegamento in figura dà come risultato una saldatura con polarità inversa. Per ottenere una saldatura con polarità diretta, invertire il collegamento.

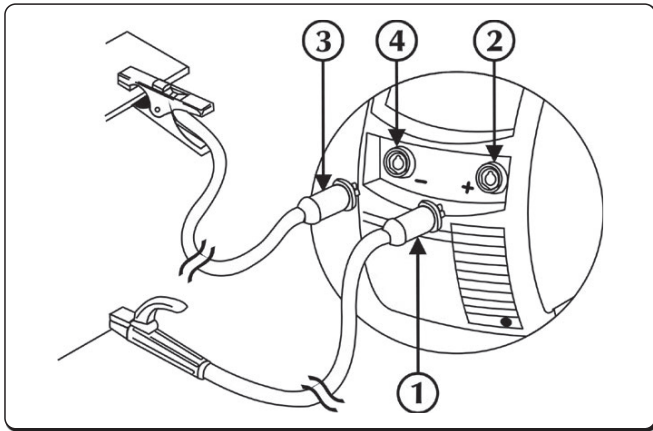

- ① Connettore pinza massa
- ② Presa negativa di potenza (-)
- ③ Connettore pinza portaelettrodo
- ④ Presa positiva di potenza (+)

- ▶ Collegare il connettore del cavo della pinza di massa alla presa negativa (-) del generatore. Inserire la spina e ruotare in senso orario fino al completo fissaggio delle parti.
- ▶ Collegare il connettore del cavo della pinza portaelettrodo alla presa positiva (+) del generatore. Inserire la spina e ruotare in senso orario fino al completo fissaggio delle parti.

2.4.2 Collegamento per saldatura TIG

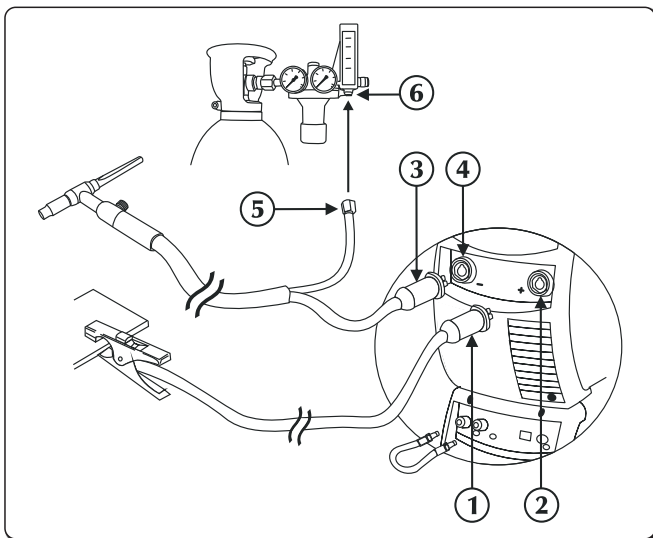



- ① Connettore pinza massa
- ② Presa positiva di potenza (+)
- ③ Attacco torcia TIG
- ④ Presa torcia
- ⑤ Connettore tubo gas
- ⑥ Riduttore pressione

- ▶ Collegare il connettore del cavo della pinza di massa alla presa positiva (+) del generatore. Inserire la spina e ruotare in senso orario fino al completo fissaggio delle parti.
- ▶ Collegare l'attacco della torcia TIG alla presa torcia del generatore. Inserire la spina e ruotare in senso orario fino al completo fissaggio delle parti.



La regolazione del flusso del gas di protezione si attua agendo su un rubinetto generalmente posto sulla torcia.

- ▶ Collegare separatamente il connettore del tubo del gas della torcia alla distribuzione del gas stesso.
- ▶ Collegare il tubo di ritorno liquido refrigerante della torcia (colore rosso) all'apposito raccordo/innesto (colore rosso simbolo )
- ▶ Collegare il tubo di mandata liquido refrigerante della torcia (colore blu) all'apposito raccordo/innesto (colore blu simbolo )

2.4.3 Collegamento per saldatura MIG/MAG

- ▶ Collegare il connettore del cavo della pinza di massa alla presa negativa (-) del generatore. Inserire la spina e ruotare in senso orario fino al completo fissaggio delle parti.

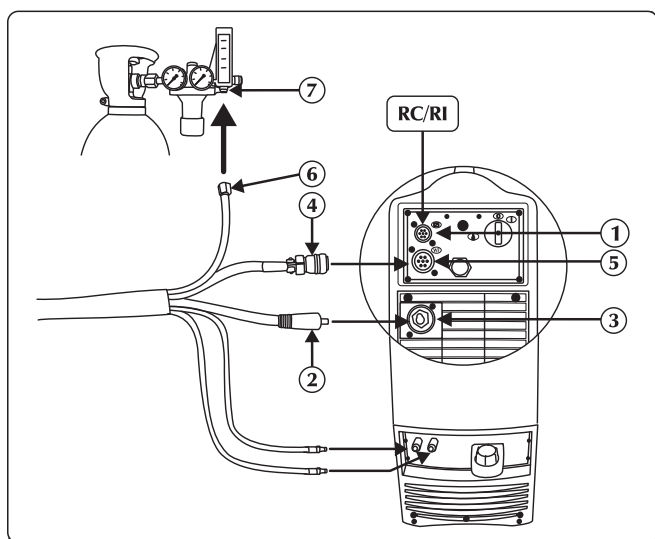

- ① Ingresso cavo di segnale (CAN-BUS)
- ② Cavo potenza
- ③ Presa positiva di potenza (+)
- ④ Cavo segnale
- ⑤ Ingresso cavo di segnale (CAN-BUS) (Fascio cavi)
- ⑥ Tubo gas
- ⑦ Raccordo alimentazione gas

- ▶ Collegare il cavo di potenza del fascio cavi all'apposita presa. Inserire la spina e ruotare in senso orario fino al completo fissaggio delle parti.
- ▶ Collegare il cavo di segnale del fascio cavi all'apposito connettore. Inserire il connettore e ruotare la ghiera in senso orario fino al completo fissaggio delle parti.
- ▶ Collegare il tubo gas del fascio cavi al riduttore di pressione della bombola o al raccordo di alimentazione del gas. Regolare il flusso gas da 10 a 30 l/min.
- ▶ Collegare il tubo di mandata liquido refrigerante del fascio cavi (colore blu) all'apposito raccordo/innesto (colore blu simbolo).
- ▶ Collegare il tubo di ritorno liquido refrigerante del fascio cavi (colore rosso) all'apposito raccordo/innesto (colore rosso simbolo).

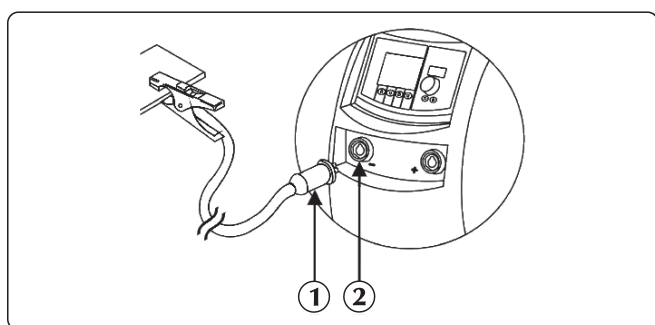

- ① Connettore pinza massa
- ② Presa negativa di potenza (-)

- ▶ Collegare il connettore del cavo della pinza di massa alla presa negativa (-) del generatore. Inserire la spina e ruotare in senso orario fino al completo fissaggio delle parti.

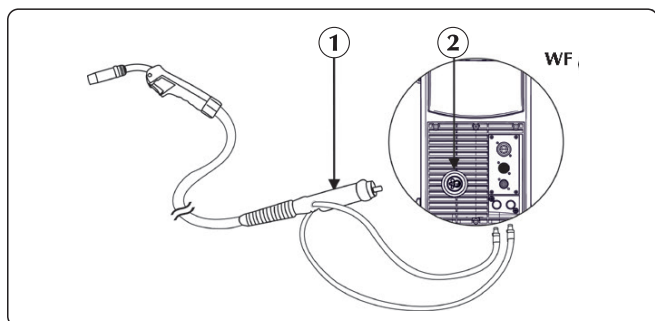

- ① Attacco torcia
- ② Connettore

- ▶ Collegare il tubo di mandata liquido refrigerante della torcia (colore blu) all'apposito raccordo/innesto (colore blu simbolo).
- ▶ Collegare il tubo di ritorno liquido refrigerante della torcia (colore rosso) all'apposito raccordo/innesto (colore rosso simbolo).
- ▶ Collegare la torcia MIG/MAG sull'attacco, prestando particolare attenzione nell'avvitare completamente la ghiera di fissaggio.

3. PRESENTAZIONE DELL'IMPIANTO

3.1 Pannello posteriore

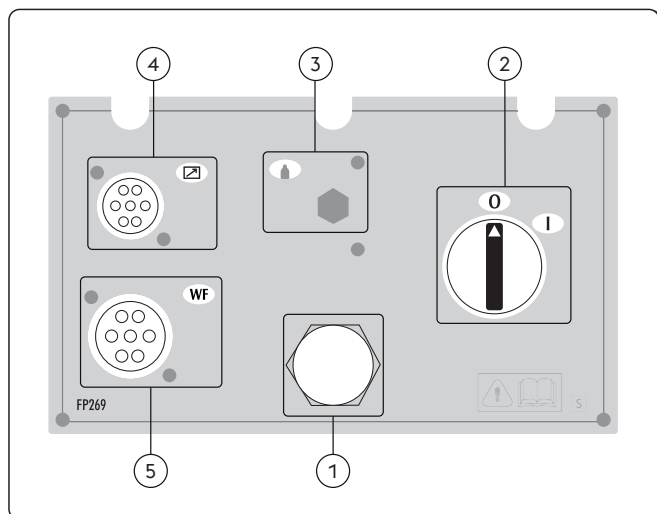

- ① **Cavo di alimentazione**
Permette di alimentare l'impianto collegandolo alla rete.
- ② **Interruttore di accensione**
Comanda l'accensione elettrica della saldatrice.
Ha due posizioni: "O" spento; "I" acceso.
- ③ **Non utilizzato**
- ④ **Ingresso cavo di segnale CAN-BUS (RC, RI...)**
- ⑤ **Ingresso cavo di segnale (CAN-BUS) (Fascio cavi)**

3.2 Pannello prese

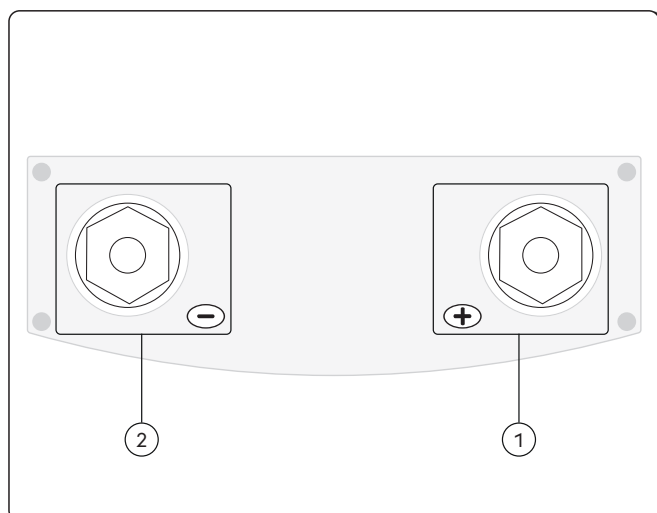

- ① **Preso positiva di potenza (+)**
Processo MMA: Connessione torcia ad elettrodo
Processo TIG: Connessione cavo di massa
- ② **Preso negativa di potenza (-)**
Processo MMA: Connessione cavo di massa
Processo TIG: Connessione torcia
Processo MIG/MAG: Connessione cavo di massa



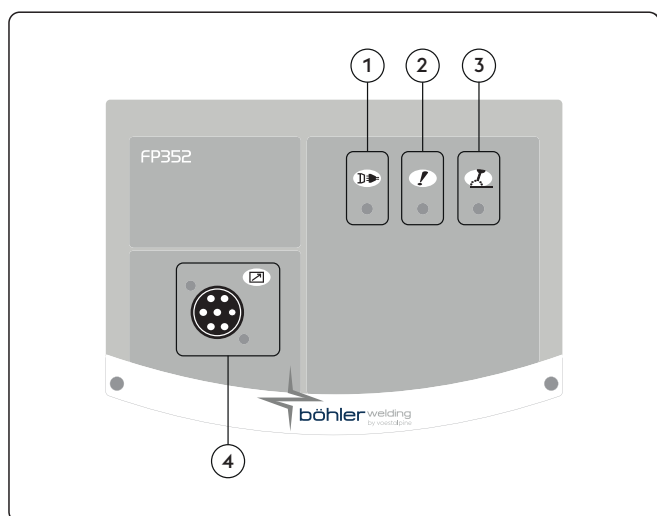



3.3 Pannello comandi frontale

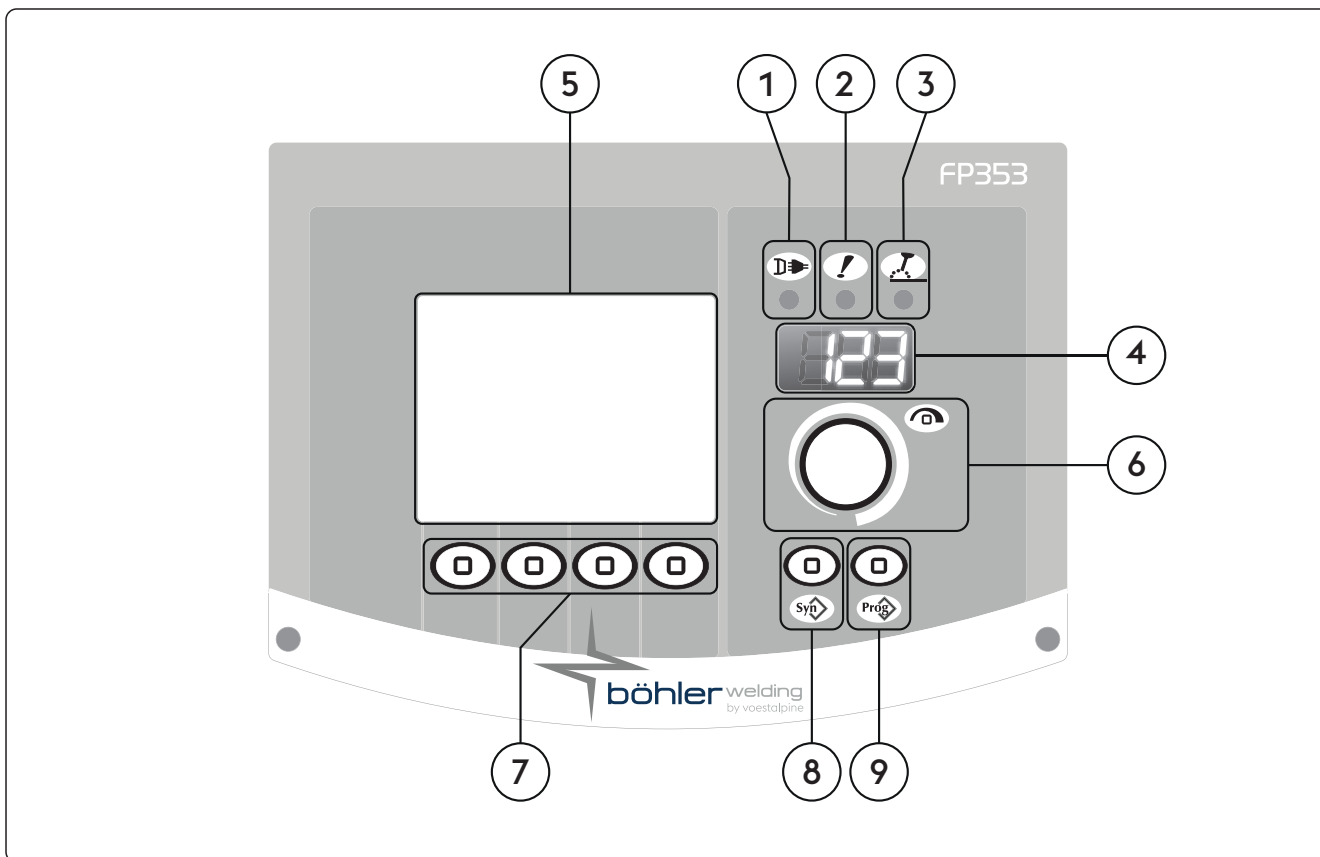

- ① **LED di alimentazione**
Indica che l'impianto è collegato alla rete elettrica e che è alimentato.
- ② **LED di allarme generale**
Indica l'eventuale intervento dei dispositivi di protezione quali la protezione termica.
- ③ **LED di potenza attiva**
Indica la presenza di tensione sulle prese d'uscita dell'impianto.
- ④ **Ingresso cavo di segnale CAN-BUS (RC, RI...)**

3.4 Pannello comandi frontale



- 1  **LED di alimentazione**
Indica che l'impianto è collegato alla rete elettrica e che è alimentato.
- 2  **LED di allarme generale**
Indica l'eventuale intervento dei dispositivi di protezione quali la protezione termica.
- 3  **LED di potenza attiva**
Indica la presenza di tensione sulle prese d'uscita dell'impianto.
- 4  **Display a 7 segmenti**
Permette di visualizzare le generalità della saldatrice in fase di partenza, le impostazioni e le letture di corrente e di tensione in saldatura, la codifica degli allarmi.
- 5  **Display LCD**
Permette di visualizzare le generalità della saldatrice in fase di partenza, le impostazioni e le letture di corrente e di tensione in saldatura, la codifica degli allarmi.
Permette di visualizzare istantaneamente tutte le operazioni.
- 6  **Manopola di regolazione principale**
Permette l'ingresso a set up, la selezione e l'impostazione dei parametri di saldatura.
- 7  **Tasti funzione**
Permettono la selezione delle varie funzionalità dell'impianto:
- Processo di saldatura
- Modalità di saldatura
- Pulsazione di corrente
- Modalità grafica

- 8** **Tasto programmi**
 Permette la selezione di un programma di saldatura preimpostato attraverso la selezione di alcune semplici informazioni:
 - Tipo di filo
 - Tipo di gas
 - Diametro filo

- 9** **Tasto job**
 Permette la memorizzazione e la gestione di 240 programmi di saldatura personalizzabili dall'operatore.

4. UTILIZZO DELL'IMPIANTO

4.1 Schermata di avvio

All'accensione, il generatore esegue una serie di verifiche atte a garantire il corretto funzionamento dell'impianto e di tutti i dispositivi ad esso connessi. In questa fase viene anche eseguito il test gas per accertare il corretto allacciamento al sistema di alimentazione del gas.

4.2 Schermata di test

Quando il pannello laterale (vano bobina) è aperto, le operazioni di saldatura vengono inibite. Sul display LCD compare la schermata di test.

The screenshot shows a blue LCD screen with the following elements:

- Top bar: G3/4 Si1 1.0mm Ar 18%CO₂ (labeled 5)
- Center: A blue box with a white arrow pointing to a side panel icon (labeled 4)
- Bottom center: A large digital display showing 3.0 m/min (labeled 3)
- Bottom left: A blue icon of a wire advance symbol (labeled 1)
- Bottom right: A blue icon of a test gas symbol (labeled 2)

Legend on the right:

- ① Avanzamento filo
- ② Test gas
- ③ Velocità filo
- ④ Pannello laterale aperto
- ⑤ Intestazione

Avanzamento filo
 Permette l'avanzamento manuale del filo senza flusso gas e senza che il filo sia in tensione. Consente l'inserimento del filo nella guaina della torcia durante le fasi di preparazione alla saldatura.

Test gas
 Permette di liberare da impurità il circuito del gas e di eseguire, senza potenza in uscita, le opportune regolazioni preliminari di pressione e portata del gas.

Velocità avanzamento filo
 Permette la regolazione della velocità di avanzamento del filo (durante la fase di caricamento).

Minimo	Massimo	Default
0.5 m/min	22.0 m/min	3.0 m/min

Pannello laterale aperto

Intestazione
 Permette la visualizzazione di alcune importanti informazioni relative al processo selezionato.

4.3 Schermata principale

Permette la gestione dell'impianto e del processo di saldatura, mostrando le impostazioni principali.

4.4 Schermata principale processo MMA

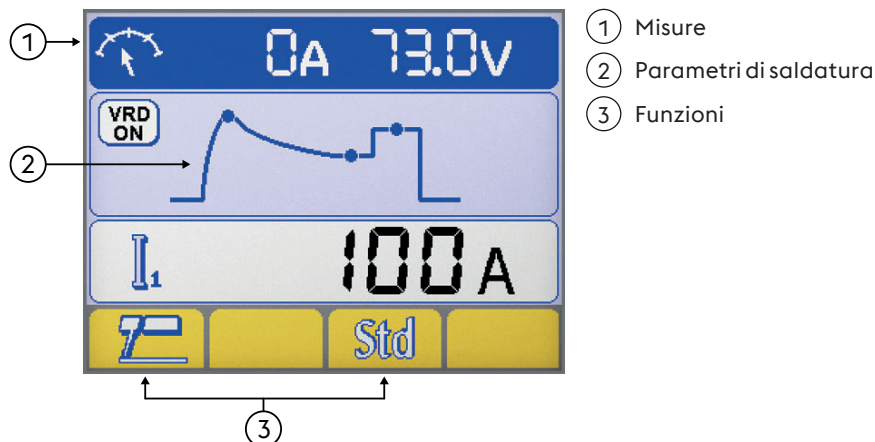

Misure

Durante le fasi di saldatura, sul display LCD vengono visualizzate le misure reali di corrente e di tensione.



Parametri di saldatura

► Selezionare il parametro desiderato premendo il tasto encoder.

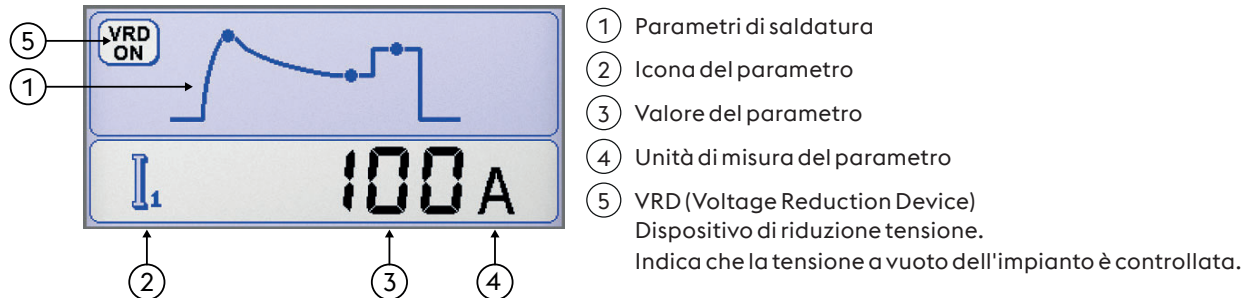

Funzioni

Permettono l'impostazione delle funzionalità di processo e delle modalità di saldatura più importanti.

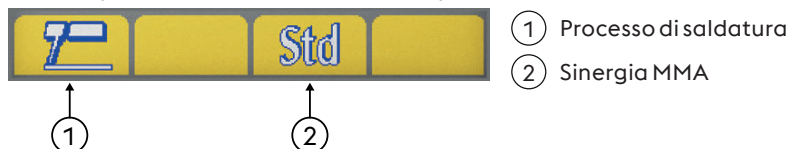

Processo di saldatura





Sinergia MMA

Permette di impostare la migliore dinamica d'arco selezionando il tipo di elettrodo utilizzato.

La selezione della corretta dinamica d'arco permette di sfruttare nel migliore dei modi le potenzialità dell'impianto al fine di ottenere le migliori prestazioni possibili in saldatura.

Standard (Basico/Rutilico)	Cellulosico	Acciaio	Alluminio	Ghisa



Non viene garantita la perfetta saldabilità dell'elettrodo utilizzato.

La saldabilità dipende dalla qualità dei consumabili e dalla loro conservazione, dalle modalità operative e dalle condizioni di saldatura, dalle numerose applicazioni possibili.

4.5 Schermata principale processo TIG

① Misure
② Parametri di saldatura
③ Funzioni

Misure

Durante le fasi di saldatura, sul display LCD vengono visualizzate le misure reali di corrente e di tensione.

① Corrente di saldatura
② Tensione di saldatura

Parametri di saldatura

① Parametri di saldatura
▶ Selezionare il parametro desiderato premendo il tasto encoder.
▶ Regolare il valore del parametro selezionato ruotando l'encoder.
② Icona del parametro
③ Valore del parametro
④ Unità di misura del parametro

Funzioni

Permettono l'impostazione delle funzionalità di processo e delle modalità di saldatura più importanti.

① Processo di saldatura

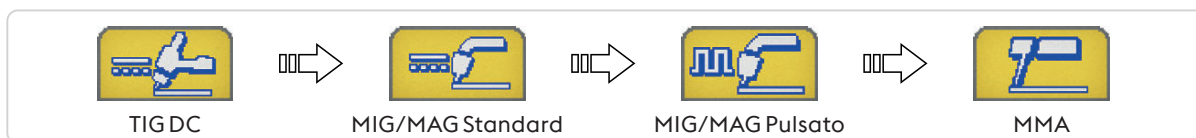
Processo di saldatura

4.6 Schermata principale processo MIG/MAG
Schermata base

① Intestazione MIG/MAG
 ② Parametri di saldatura
 ③ Funzioni

Schermata grafica

① Intestazione MIG/MAG
 ② Parametri di saldatura
 ③ Funzioni

Intestazione MIG/MAG

Permette la visualizzazione di alcune importanti informazioni relative al processo selezionato.

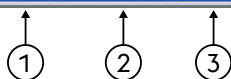
 G3/4 Si1 1.0mm Ar 18%CO₂

Curva sinerica selezionata

- ① Tipo di materiale d'apporto
- ② Diametro filo
- ③ Tipo di gas

I 118A 2.2mm 3.4mm V 19.5V

Parametri di saldatura

- ① Corrente di saldatura
- ② Spessore pezzo
- ③ Cordone d'angolo
- ④ Tensione di saldatura

Parametri di saldatura (Schermata base)

► Selezionare il parametro desiderato premendo il tasto encoder.

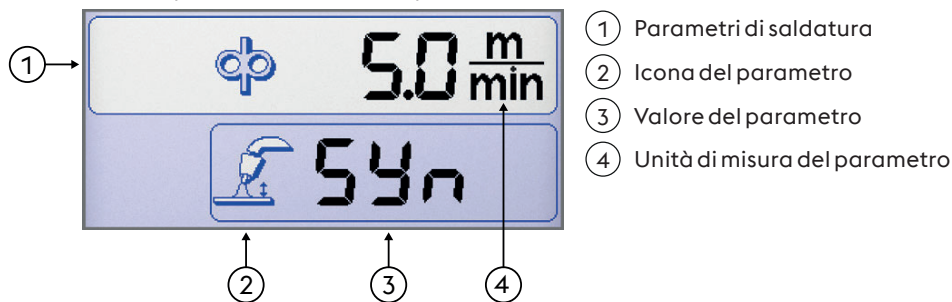

- ① Parametri di saldatura
- ② Icona del parametro
- ③ Valore del parametro
- ④ Unità di misura del parametro

Parametri di saldatura (Schermata grafica)

► Selezionare il parametro desiderato premendo il tasto encoder.

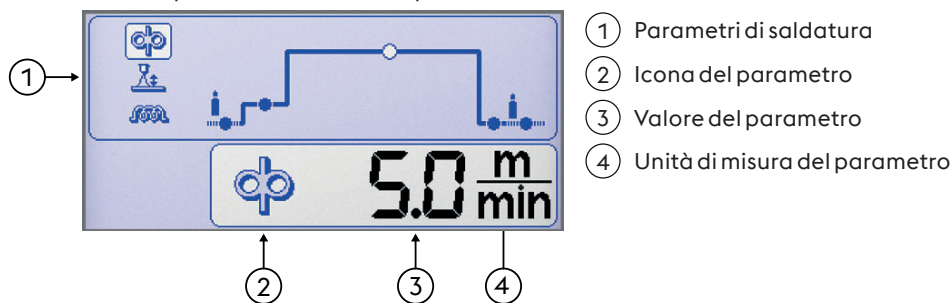

- ① Parametri di saldatura
- ② Icona del parametro
- ③ Valore del parametro
- ④ Unità di misura del parametro

Funzioni

Permettono l'impostazione delle funzionalità di processo e delle modalità di saldatura più importanti.

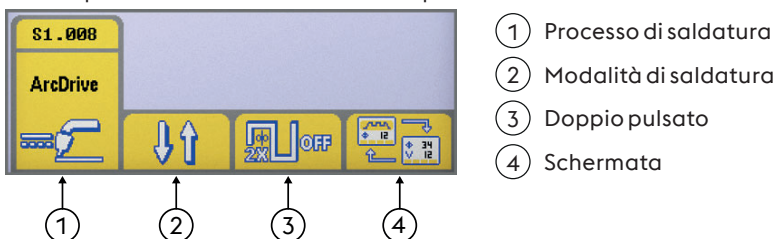

- ① Processo di saldatura
- ② Modalità di saldatura
- ③ Doppio pulsato
- ④ Schermata



Processo di saldatura

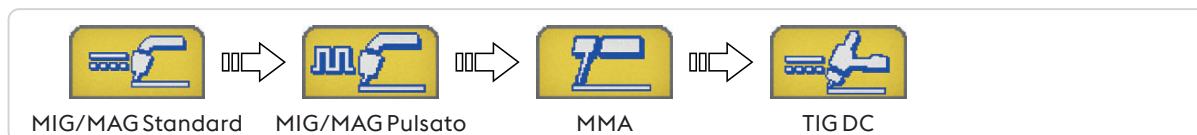



Modalità di saldatura



Consente la selezione della modalità di saldatura

- 2 Tempi**
In due tempi la pressione del pulsante fa fluire il gas, attiva la tensione sul filo e lo fa avanzare; al rilascio il gas, la tensione e l'avanzamento del filo vengono tolti.
- 4 Tempi**
In quattro tempi la prima pressione del pulsante fa fluire il gas effettuando un pre gas manuale, al rilascio viene attivata la tensione sul filo e il suo avanzamento. La successiva pressione del pulsante blocca il filo e fa iniziare il processo finale che porta la corrente a zero, il rilascio definitivo del pulsante toglie l'afflusso del gas.
- Crater filler**
Permette di eseguire una saldatura con tre diversi livelli di potenza selezionabili e gestibili direttamente dal saldatore attraverso il pulsante torcia.
La prima pressione del pulsante torcia fa fluire il gas, attiva la tensione sul filo e lo fa avanzare alla velocità impostata nel parametro "incremento iniziale" (a set up) e con i relativi valori sinergici dei parametri di saldatura.
Al rilascio del pulsante torcia, la velocità del filo e i relativi parametri sinergici passano automaticamente ai valori principali impostato sul pannello comandi.
La successiva pressione del pulsante torcia porta la velocità filo e i relativi parametri sinergici ai valori preimpostati nel parametro (a set up) crater filler.
Il rilascio del pulsante torcia, blocca l'avanzamento del filo e l'erogazione della potenza eseguendo burn back e post gas.

Doppio pulsato

 Doppio pulsato attivo  Doppio pulsato non attivo

Schermata
Permette il cambio di visualizzazione tra:

 Schermata base  Schermata grafica

Schermata curve sinergiche





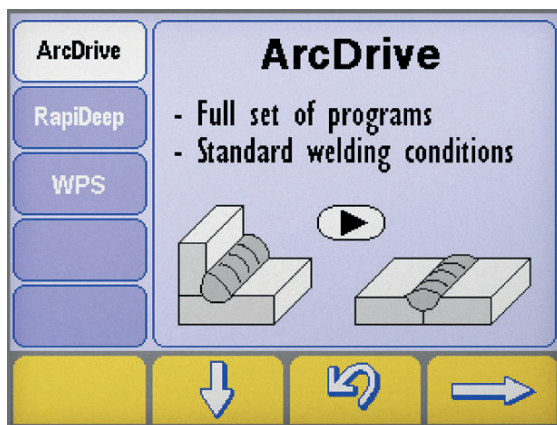

Sinergia

Permette la selezione di un programma di saldatura preimpostato (sinergia) attraverso la selezione di alcune semplici informazioni

Selezione processo di saldatura



- ▶ Entrare nella schermata "sinergie" premendo il tasto  per almeno un secondo.
- ▶ Selezionare il processo desiderato premendo i tasti  e .
- ▶ Premere il pulsante  per passare allo step successivo.

Processo di saldatura



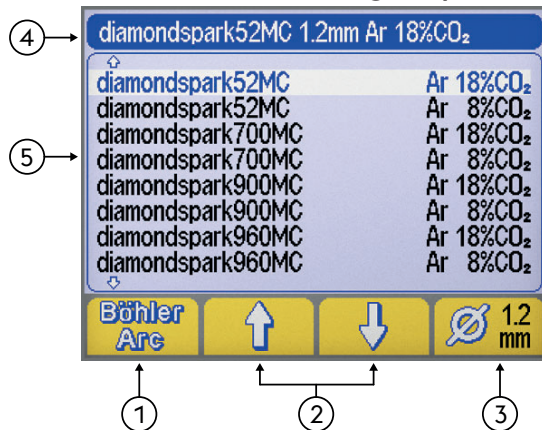

Schermata selezione sinergia Tipo materiale/Tipo gas





- ① Programma di saldatura (BöhlerArc/UniversalArc)
- ② Selezione materiale/gas
- ③ Diametro filo
- ④ Intestazione
- ⑤ Programma di saldatura

Programma di saldatura
Consente la selezione del programma di saldatura

  BöhlerArc  UniversalArc

Selezione materiale/gas
Permette la selezione di:

- Tipo di materiale d'apporto
- Tipo di gas



Diametro filo

Permette la selezione del diametro del filo utilizzato (mm).

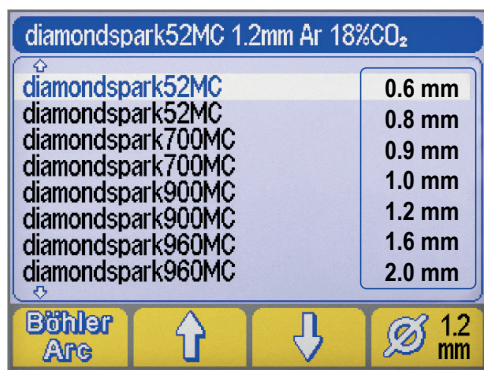

① Diametro filo



Intestazione

Permette la visualizzazione di alcune importanti informazioni relative al processo selezionato.



NO PROGRAM

Indica che la curva sinergica selezionata non è disponibile o non è coerente con le altre impostazioni dell'impianto.

4.7 Schermata programmi



Permette la memorizzazione e la gestione di 240 programmi di saldatura personalizzabili dall'operatore.

Programmi (JOB)

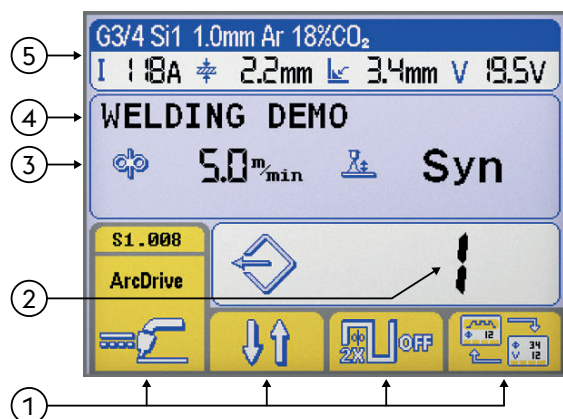

- ① Funzioni
- ② Numero programma selezionato
- ③ Parametri principali del programma selezionato
- ④ Descrizione del programma selezionato
- ⑤ Intestazione

Consultare la sezione "Schermata principale"

Memorizzazione programma

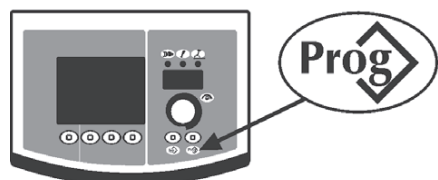

▶ Entrare nella schermata "memorizzazione programma" premendo il tasto per almeno un secondo.



▶ Selezionare il programma (o la memoria vuota) desiderato ruotando l'encoder.

--- Memoria vuota

Programma memorizzato

▶ Annullare l'operazione premendo il tasto .

▶ Salvare tutte le impostazioni correnti sul programma selezionato premendo il tasto .



Inserire una descrizione del programma.

- ▶ Selezionare la lettera desiderata ruotando l'encoder.
- ▶ Memorizzare la lettera selezionata premendo l'encoder.
- ▶ Cancellare l'ultima lettera premendo il tasto
- ▶ Annullare l'operazione premendo il tasto
- ▶ Confermare l'operazione premendo il tasto



La memorizzazione di un nuovo programma su una memoria già occupata implica la cancellazione della memoria attraverso una procedura obbligatoria.



- ▶ Annullare l'operazione premendo il tasto
- ▶ Eliminare il programma selezionato premendo il tasto
- ▶ Riprendere la procedura di memorizzazione.

Richiamo programmi

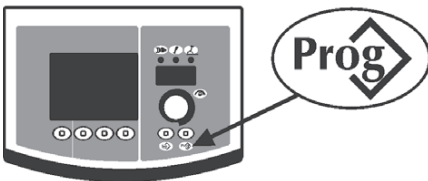

- ▶ Richiamare il 1° programma disponibile premendo il tasto
- ▶ Selezionare il programma desiderato ruotando l'encoder.
- ▶ Selezionare il programma desiderato premendo il tasto



Vengono richiamate solamente le memorie occupate da un programma, mentre quelle vuote vengono automaticamente saltate.

Cancellazione programmi



- ▶ Selezionare il programma desiderato ruotando l'encoder.
- ▶ Eliminare il programma selezionato premendo il tasto
- ▶ Annullare l'operazione premendo il tasto



- ▶ Annullare l'operazione premendo il tasto
- ▶ Eliminare il programma selezionato premendo il tasto

5. SETUP

5.1 Set up e impostazione dei parametri

Permette l'impostazione e la regolazione di una serie di parametri aggiuntivi per una migliore e più precisa gestione dell'impianto di saldatura.

I parametri presenti a set up sono organizzati in relazione al processo di saldatura selezionato e hanno una codifica numerica.

Ingresso a set up



- ▶ Avviene premendo per 5 secondi il tasto encoder.
- ▶ L'entrata sarà confermata dalla scritta 0 sul display.

Selezione e regolazione del parametro desiderato

- ▶ Avviene ruotando l'encoder fino a visualizzare il codice numerico relativo al parametro desiderato.
- ▶ La pressione del tasto encoder, a questo punto, permette la visualizzazione del valore impostato per il parametro selezionato e la sua regolazione.

Uscita da set up

- ▶ Per uscire dalla sezione "regolazione" premere nuovamente l'encoder.
- ▶ Per uscire dal set up portarsi sul parametro "0" (salva ed esci) e premere l'encoder.
- ▶ Annullare l'operazione premendo il tasto .
- ▶ Per salvare la modifica ed uscire dal set up premere il tasto: .

5.1.1 Elenco parametri a set up (MMA)



0 Salva ed esci

Permette di salvare le modifiche e di uscire dal set up.



1 Reset

Permette di reimpostare tutti i parametri ai valori di default.



3 Hot start

Permette la regolazione del valore di hot start in MMA.

Consente una partenza più o meno "calda" nelle fasi d'innescio dell'arco facilitando di fatto le operazioni di start.

Elettrodo Basico

Minimo	Massimo	Default
0/off	500%	80%

Elettrodo Cellulosico

Minimo	Massimo	Default
0/off	500%	150%

Elettrodo CrNi

Minimo	Massimo	Default
0/off	500%	100%

Elettrodo Alluminio

Minimo	Massimo	Default
0/off	500%	120%

Elettrodo Cast Iron

Minimo	Massimo	Default
0/off	500%	100%

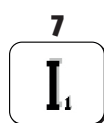

7 Corrente di saldatura

Permette la regolazione della corrente di saldatura.

Minimo	Massimo	Default
3 A	I _{max}	100 A

8 Arc force

Permette la regolazione del valore dell'Arc force in MMA.
Consente una risposta dinamica più o meno energetica in saldatura facilitando di fatto le operazioni del saldatore.

Aumentare il valore dell'Arc force per ridurre i rischi di incollamento dell'elettrodo.

Elettrodo Basico

Minimo	Massimo	Default
0/off	500%	30%

Elettrodo Cellulosico

Minimo	Massimo	Default
0/off	500%	350%

Elettrodo CrNi

Minimo	Massimo	Default
0/off	500%	30%

Elettrodo Alluminio

Minimo	Massimo	Default
0/off	500%	100%

Elettrodo Cast Iron

Minimo	Massimo	Default
0/off	500%	70%

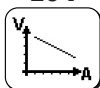
204 Dynamic power control (DPC)

Permette la selezione della caratteristica V/I desiderata.

I=C Corrente costante

L'aumento o la riduzione dell'altezza dell'arco non ha alcuna incidenza sulla corrente di saldatura erogata.

Consigliato per elettrodo: Basico, Rutilico, Acido, Acciaio, Ghisa

1:20 Caratteristica cadente con regolazione di rampa

L'aumento dell'altezza dell'arco provoca la riduzione della corrente di saldatura (e viceversa) secondo il valore impostato da 1 a 20 Ampere per ogni Volt.

Consigliato per elettrodo: Cellulosico, Alluminio

P=C Potenza costante

L'aumento dell'altezza dell'arco provoca la riduzione della corrente di saldatura (e viceversa) secondo la legge: $V \cdot I = K$

Consigliato per elettrodo: Cellulosico, Alluminio

312 Tensione di stacco arco

Permette di impostare il valore di tensione al quale viene forzato lo spegnimento dell'arco elettrico.

Consente di gestire al meglio le varie condizioni operative che si vengono a creare.

In fase di puntatura, per esempio, una bassa tensione di stacco d'arco permette una minore sfiammata nell'allontanamento dell'elettrodo dal pezzo riducendo spruzzi, bruciature e ossidazione del pezzo.

Se si utilizzano elettrodi che richiedono alte tensioni è invece consigliabile impostare una soglia alta per evitare spegnimenti d'arco durante la saldatura.



Non impostare mai una tensione di stacco arco maggiore della tensione a vuoto del generatore.

Elettrodo Basico

Minimo	Massimo	Default
0/off	99.9 V	57.0 V

Elettrodo Cellulosico

Minimo	Massimo	Default
0/off	99.9 V	70.0 V

399 Velocità di spostamento

Permette l'impostazione della velocità di esecuzione della saldatura.

Default cm/min: velocità di riferimento per la saldatura manuale.

Syn: valore sinergico.

Minimo	Massimo	Default
1 cm/min	200 cm/min	15 cm/min

500 Impostazione macchina

Permette la selezione dell'interfaccia grafica desiderata.

Permette di accedere ai livelli superiori del set up.

Consultare la sezione "Personalizzazione interfaccia (Set up 500)"

Valore	Interfaccia Utente
XE	Modalità Easy
XA	Modalità Advanced
XP	Modalità Professional

Valore	Livello selezionato
USER	Utente
SERV	Service
vaBW	vaBW

551 Lock/unlock



Permette il blocco dei comandi del pannello e l'inserzione di un codice di protezione. Consultare la sezione "Lock/unlock (Set up 551)".

552 Tono cicalino



Permette la regolazione del tono del cicalino.

Minimo	Massimo	Default
0/off	10	10

601 Passo di regolazione



Permette la regolazione di un parametro con passo personalizzabile dall'operatore.

Minimo	Massimo	Default
1	Imax	1

602 Parametro esterno CH1, CH2, CH3, CH4



Permette la gestione del parametro esterno 1, 2, 3, 4 (valore minimo, valore massimo, valore di default, parametro selezionato).

Consultare la sezione "Gestione comandi esterni (Set up 602)".

705 Taratura resistenza circuito



Permette la taratura dell'impianto.

Consultare la sezione "Taratura resistenza circuito (set up 705)".

751 Lettura di corrente



Permette la visualizzazione del valore reale della corrente di saldatura.

752 Lettura di tensione



Permette la visualizzazione del valore reale della tensione di saldatura.

768 Misura apporto termico HI



Permette la lettura del valore della misura dell'apporto termico in saldatura.

5.1.2 Elenco parametri a set up (TIG)

0 Salva ed esci



Permette di salvare le modifiche e di uscire dal set up.

1 Reset



Permette di reimpostare tutti i parametri ai valori di default.

7 Corrente di saldatura



Permette la regolazione della corrente di saldatura.

Minimo	Massimo	Default
3 A	Imax	100 A

399 Velocità di spostamento



Permette l'impostazione della velocità di esecuzione della saldatura.

Default cm/min: velocità di riferimento per la saldatura manuale.

Syn: valore sinergico.

Minimo	Massimo	Default
1 cm/min	200 cm/min	10 cm/min

500 Impostazione macchina

Permette la selezione dell'interfaccia grafica desiderata.
 Permette di accedere ai livelli superiori del set up.
 Consultare la sezione "Personalizzazione interfaccia (Set up 500)"

Valore	Interfaccia Utente	Valore	Livello selezionato
XE	Modalità Easy	USER	Utente
XA	Modalità Advanced	SERV	Service
XP	Modalità Professional	vaBW	vaBW

551 Lock/unlock

Permette il blocco dei comandi del pannello e l'inserzione di un codice di protezione.
 Consultare la sezione "Lock/unlock (Set up 551)".

552 Tono cicalino

Permette la regolazione del tono del cicalino.

Minimo	Massimo	Default
0/off	10	10

601 Passo di regolazione

Permette la regolazione di un parametro con passo personalizzabile dall'operatore.

Minimo	Massimo	Default
1	lmax	1

602 Parametro esterno CH1, CH2, CH3, CH4

Permette la gestione del parametro esterno 1, 2, 3, 4 (valore minimo, valore massimo, valore di default, parametro selezionato).
 Consultare la sezione "Gestione comandi esterni (Set up 602)".

705 Taratura resistenza circuito

Permette la taratura dell'impianto.
 Consultare la sezione "Taratura resistenza circuito (set up 705)".

751 Lettura di corrente

Permette la visualizzazione del valore reale della corrente di saldatura.

752 Lettura di tensione

Permette la visualizzazione del valore reale della tensione di saldatura.

755 Lettura di portata gas (WFR)

Permette la visualizzazione del valore reale del flusso gas.

757 Lettura velocità filo

Lettura encoder motore 1.

760 Lettura di corrente (motore 1)

Permette la visualizzazione del valore reale della corrente (motore 1).

764 Lettura flusso liquido refrigerante

Permette la visualizzazione del valore del flusso liquido refrigerante.

765

Letture di temperatura liquido refrigerante

Permette la visualizzazione del valore reale della temperatura del liquido refrigerante.



768

Misura apporto termico HI

Permette la lettura del valore della misura dell'apporto termico in saldatura.



801

Limiti di guardia

Permette l'impostazione dei limiti di attenzione e dei limiti di guardia.

Permette di controllare il processo di saldatura impostando sui principali parametri misurabili limiti di attenzione e limiti di guardia.

Consente il controllo accurato delle varie fasi di saldatura.

Consultare la sezione "Limiti di guardia (Set up 801)".



5.1.3 Elenco parametri a set up (MIG/MAG)

0

Salva ed esci

Permette di salvare le modifiche e di uscire dal set up.



1

Reset

Permette di reimpostare tutti i parametri ai valori di default.



2

Sinergia

MIG/MAG Standard:

Permette la selezione del processo MIG manuale (Off) o MIG sinergico (**6**) impostando il tipo di materiale da saldare.

MIG/MAG Pulsato:

Permette la selezione del processo MIG sinergico (**6**) impostando il tipo di materiale da saldare.
Permette la selezione del processo CC/CV.



3

Velocità filo

Permette la regolazione della velocità di avanzamento del filo.



Minimo	Massimo	Default
0.5 m/min	22.0 m/min	-

4

Corrente

Permette la regolazione della corrente di saldatura.



Minimo	Massimo
3 A	I _{max}

5

Spessore pezzo

Permette l'impostazione dello spessore del pezzo da saldare.

Consente l'impostazione dell'impianto attraverso la regolazione del pezzo da saldare.



6

Cordone d'angolo "a"

Permette l'impostazione della profondità del cordone in un giunto d'angolo.



7 Tensione - Lunghezza d'arco



Permette la regolazione della tensione dell'arco.
Consente la regolazione della lunghezza d'arco in saldatura.

Tensione alta = arco lungo

Tensione bassa = arco corto

Modalità manuale

Minimo	Massimo	Default
5.0 V	55.5 V	5.0 V

10 Pre gas



Permette di impostare e regolare il flusso di gas prima dell'innesco dell'arco.
Consente il caricamento del gas in torcia e la preparazione dell'ambiente per la saldatura.

Minimo	Massimo	Default
0/off	99.9 s	0.1 s

11 Soft start



Permette la regolazione della velocità di avanzamento del filo nelle fasi che precedono l'innesco.
Consente un innesco a velocità ridotta e pertanto più morbido e con meno spruzzi.

Minimo	Massimo	Default
10 %	100 %	50 %

12 Rampa motore



Permette di impostare un passaggio graduale tra la velocità filo d'innesco e quella di saldatura.

Minimo	Massimo	Default
0/off	1.0 s	0/off

15 Burn back

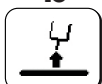

Permette la regolazione del tempo di bruciatura del filo impedendo l'incollamento a fine saldatura.
Consente di regolare la lunghezza del pezzo di filo esterno alla torcia.

Minimo	Massimo	Default
-2.00	+2.00	0/syn

16 Post gas



Permette di impostare e regolare il flusso di gas a fine saldatura.

Minimo	Massimo	Default
0/off	99.9 s	2.0 s

19 Duty cycle (doppio pulsato)

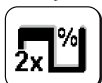

Permette la regolazione del duty cycle in doppio pulsato.

Minimo	Massimo	Default
10 %	90 %	50 %

20 Doppio pulsato



Permette la regolazione dell'ampiezza della pulsazione.

Minimo	Massimo	Default
0 %	100 %	±25 %

Minimo	Massimo	Default
0.5 m/min	22 m/min	2.5 m/min

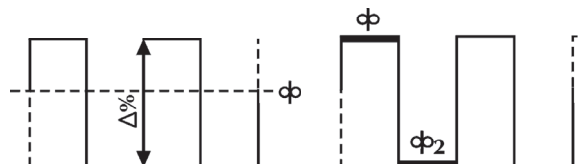

21 Frequenza di pulsazione (doppio pulsato)



Permette la regolazione del periodo, cioè del ciclo di ripetizione della pulsazione.
Consente di regolare la frequenza dell'impulso.

Minimo	Massimo	Default
0.1 Hz	5.0 Hz	2.0 Hz

22 Tensione secondaria (doppio pulsato)



Permette la regolazione della tensione del livello di pulsazione secondario. Consente di ottenere una maggiore stabilità d'arco nelle varie fasi di pulsazione.

Minimo	Massimo	Default
-5.0	+5.0	0/syn

23 Rampe pulsato (doppio pulsato)



Permette l'impostazione di un tempo di rampa nella fase di pulsazione.

Minimo	Massimo	Default
1 %	100 %	50 %

24 Bilevel (4T - crater filler)



Permette la regolazione della velocità filo secondaria nella modalità di saldatura bilevel.

Se il saldatore preme e rilascia velocemente il pulsante si passa ad "ϕ₂".

Premendo e rilasciando velocemente il pulsante si passa nuovamente ad "ϕ" e così via.

Minimo	Massimo	Default
1 %	200 %	0/off

25 Incremento iniziale



Permette di regolare il valore della velocità filo durante la prima fase di saldatura del "crater-filler".

Consente di incrementare l'energia fornita al pezzo nella fase in cui il materiale (ancora freddo) necessita di maggior calore per fondere in modo omogeneo.

Minimo	Massimo	Default
20 %	200 %	120 %

26 Crater filler



Permette di regolare il valore della velocità filo durante la fase di chiusura della saldatura.

Consente di ridurre l'energia fornita al pezzo nella fase in cui il materiale è già molto caldo, riducendo i rischi di inutili deformazioni.

Minimo	Massimo	Default
20 %	200 %	80 %

27 Temporizzazione incremento iniziale



Permette l'impostazione del tempo di incremento iniziale.

Consente di automatizzare la funzione "crater filler".

Minimo	Massimo	Default
0.1 s	99.9 s	0/off

28 Temporizzazione crater filler



Permette l'impostazione del tempo di "crater filler".

Consente di automatizzare la funzione "crater filler".

Minimo	Massimo	Default
0.1 s	99.9 s	0/off

30 Puntatura

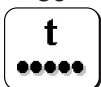

Permette di abilitare il processo "puntatura" e di stabilire il tempo di saldatura.

Minimo	Massimo	Default
0.1 s	99.9 s	0/off

31 Punto pausa



Permette di abilitare il processo "punto pausa" e di stabilire il tempo di sosta tra una saldatura e l'altra.

Minimo	Massimo	Default
0.1 s	99.9 s	0/off

32 Tensione secondaria (Bilevel MIG)

Permette la regolazione della tensione del livello di pulsazione secondario.
Consente di ottenere una maggiore stabilità d'arco nelle varie fasi di pulsazione.

Minimo	Massimo	Default
-5.0	+5.0	0/syn

33 Induttanza secondaria (Bilevel MIG)

Permette la regolazione dell'induttanza del livello di pulsazione secondario.
Consente di ottenere un arco più o meno rapido nella compensazione dei movimenti del saldatore e della naturale instabilità di saldatura.

Induttanza bassa = arco reattivo (maggiori spruzzi).

Induttanza alta = arco poco reattivo (spruzzi ridotti).

Minimo	Massimo	Default
-30	+30	0/syn

34 Rampa incremento iniziale

Permette di impostare un passaggio graduale tra l'incremento iniziale e la saldatura.

Minimo	Massimo	Default
0 s	10 s	0/off

35 Rampa crater filler

Permette di impostare un passaggio graduale tra la saldatura e il crater filler.

Minimo	Massimo	Default
0 s	10 s	0/off

202 Induttanza

Permette una regolazione elettronica dell'induttanza serie del circuito di saldatura.
Consente di ottenere un arco più o meno rapido nella compensazione dei movimenti del saldatore e della naturale instabilità di saldatura.

Induttanza bassa = arco reattivo (maggiori spruzzi).

Induttanza alta = arco poco reattivo (spruzzi ridotti).

Minimo	Massimo	Default
-30	+30	0/syn

331 Tensione media compensata

Permette l'impostazione della tensione di saldatura.

399 Velocità di spostamento

Permette l'impostazione della velocità di esecuzione della saldatura.

Default cm/min: velocità di riferimento per la saldatura manuale.

Syn: valore sinergico.

Minimo	Massimo	Default
syn min	syn max	35 cm/min

500 Impostazione macchina

Permette la selezione dell'interfaccia grafica desiderata.

Permette di accedere ai livelli superiori del set up.

Consultare la sezione "Personalizzazione interfaccia (Set up 500)"

Valore	Interfaccia Utente	Valore	Livello selezionato
XE	Modalità Easy	USER	Utente
XA	Modalità Advanced	SERV	Service
XP	Modalità Professional	vaBW	vaBW

551 Lock/unlock

Permette il blocco dei comandi del pannello e l'inserzione di un codice di protezione.

Consultare la sezione "Lock/unlock (Set up 551)".

552 Tono cicalino



Permette la regolazione del tono del cicalino.

Minimo	Massimo	Default
0/off	10	10

601 Passo di regolazione



Permette la regolazione di un parametro con passo personalizzabile dall'operatore. Funzionalità controllabile tramite pulsante up/down della torcia.

Minimo	Massimo	Default
1	Imax	1

602 Parametro esterno CH1, CH2, CH3, CH4



Permette la gestione del parametro esterno 1, 2, 3, 4 (valore minimo, valore massimo, valore di default, parametro selezionato).

Consultare la sezione "Gestione comandi esterni (Set up 602)".

606 Torcia U/D



Permette la gestione del parametro esterno (U/D).

Valore	Default	Funzione Richiamata
0/off	-	off
1/11	X	Corrente
	-	Richiamo programmi

705 Taratura resistenza circuito



Permette la taratura dell'impianto.

Consultare la sezione "Taratura resistenza circuito (set up 705)".

751 Lettura di corrente



Permette la visualizzazione del valore reale della corrente di saldatura.

752 Lettura di tensione



Permette la visualizzazione del valore reale della tensione di saldatura.

755 Lettura di portata gas (WFR)



Permette la visualizzazione del valore reale del flusso gas.

757 Lettura velocità filo



Letture encoder motore 1.

758 Velocità di spostamento robot



Permette la visualizzazione della velocità di spostamento del braccio di un robot o di una automazione.

760 Lettura di corrente (motore 1)



Permette la visualizzazione del valore reale della corrente (motore 1).

761 Lettura velocità filo



Letture encoder motore 2.

762 Lettura di corrente (motore 2)

Permette la visualizzazione del valore reale della corrente (motore 2).

763 Lettura velocità filo

Lettura reale dell'avanzamento del filo.

764 Lettura flusso liquido refrigerante

Permette la visualizzazione del valore del flusso liquido refrigerante.

765 Lettura di temperatura liquido refrigerante

Permette la visualizzazione del valore reale della temperatura del liquido refrigerante.

768 Misura apporto termico HI

Permette la lettura del valore della misura dell'apporto termico in saldatura.

801 Limiti di guardia

Permette l'impostazione dei limiti di attenzione e dei limiti di guardia.

Permette di controllare il processo di saldatura impostando sui principali parametri misurabili limiti di attenzione e limiti di guardia.

Consente il controllo accurato delle varie fasi di saldatura.

Consultare la sezione "Limiti di guardia (Set up 801)".

5.2 Procedure specifiche di utilizzo dei parametri

5.2.1 Personalizzazione display 7 segmenti

Permette di visualizzare costantemente il valore di un parametro sul display 7 segmenti.

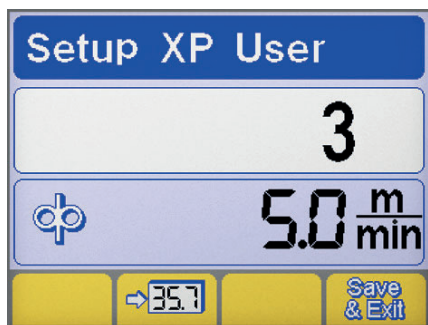

- ▶ Entrare nel set up premendo il tasto encoder per almeno 5 secondi.
- ▶ Selezionare il parametro desiderato ruotando l'encoder.
- ▶ Memorizzare il parametro selezionato nel display 7 segmenti premendo il tasto .
- ▶ Salvare ed uscire dalla schermata corrente premendo il tasto .

5.2.2 Personalizzazione interfaccia (Set up 500)

Permette di personalizzare i parametri nella schermata principale.

500 Impostazione macchina

Permette la selezione dell'interfaccia grafica desiderata.

Valore	Interfaccia Utente
XE	Modalità Easy
XA	Modalità Advanced
XP	Modalità Professional

MODALITÀ XE

MMA	
Parametri di saldatura	
TIG	
Parametri di saldatura	
Funzioni	
MIG/MAG	
Parametri di saldatura	
Funzioni	

MODALITÀ XA

MMA	
Parametri di saldatura	
Funzioni	
TIG	
Parametri di saldatura	
Funzioni	
MIG/MAG	
Parametri di saldatura	
Funzioni	

MODALITÀ XP

MMA	
Parametri di saldatura	
Funzioni	
TIG	
Parametri di saldatura	
Funzioni	

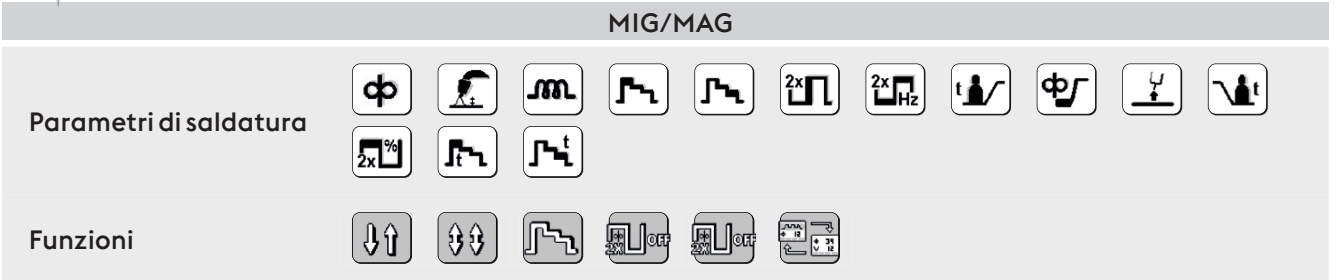

5.2.3 Lock/unlock (Set up 551)

Permette il blocco dei comandi del pannello e l'inserimento di un codice di protezione.

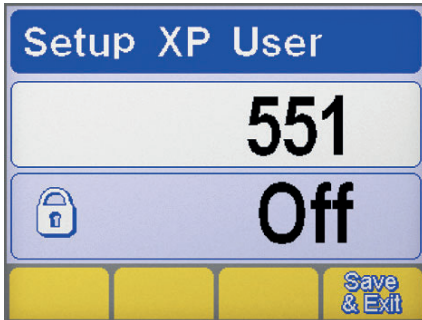

Selezione parametro

- ▶ Entrare nel set up premendo il tasto encoder per almeno 5 secondi.
- ▶ Selezionare il parametro desiderato (551).
- ▶ Attivare la regolazione del parametro selezionato premendo il tasto encoder.

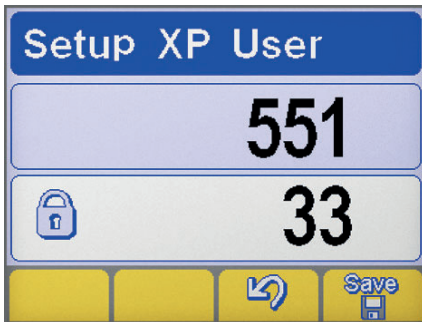

- ▶ Impostare una codifica numerica (password) ruotando l'encoder.
- ▶ Confermare l'operazione premendo il tasto-encoder.
- ▶ Annullare l'operazione premendo il tasto
- ▶ Per salvare la modifica premere il pulsante:

Funzioni pannello



L'esecuzione di qualsiasi operazione su un pannello comandi bloccato provoca la comparsa di una speciale schermata.

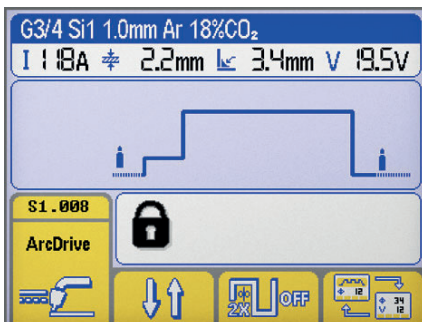

- ▶ Accedere temporaneamente (5 minuti) alle funzionalità del pannello ruotando l'encoder ed inserendo il corretto codice numerico.
- ▶ Confermare l'operazione premendo il tasto-encoder.
- ▶ Sbloccare definitivamente il pannello comandi entrando nel set up (seguire le indicazioni precedentemente descritte) e riportare il parametro 551 a "off".
- ▶ Confermare l'operazione premendo il tasto-encoder.
- ▶ Per salvare la modifica premere il pulsante:

5.2.4 Gestione comandi esterni (Set up 602)

Permette la gestione del parametro esterno 2 (valore minimo, valore massimo, valore di default, parametro selezionato).

Selezione parametro



- ▶ Entrare nel set up premendo il tasto encoder per almeno 5 secondi.
- ▶ Selezionare il parametro desiderato (602).
- ▶ Entrare nella schermata "Gestione comandi esterni" premendo il tasto encoder.

Gestione comandi esterni

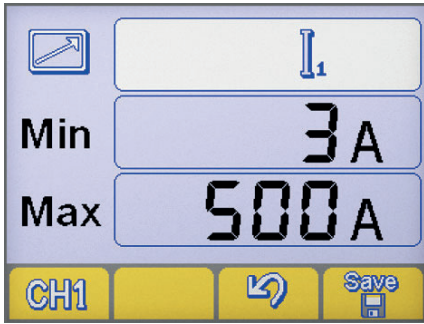

- ▶ Selezionare l'uscita di controllo RC desiderata (CH1, CH2, CH3, CH4) premendo il tasto **CH1**
- ▶ Selezionare il parametro desiderato (Min-Max-parametro) premendo il tasto encoder.
- ▶ Regolare il parametro desiderato (Min-Max-parametro) ruotando l'encoder.
- ▶ Per salvare la modifica premere il pulsante: **Save**.
- ▶ Annullare l'operazione premendo il tasto **↶**.

5.2.5 Taratura resistenza circuito (set up 705)

Consente di tarare il generatore sulla resistenza del circuito di saldatura attuale.

Selezione parametro

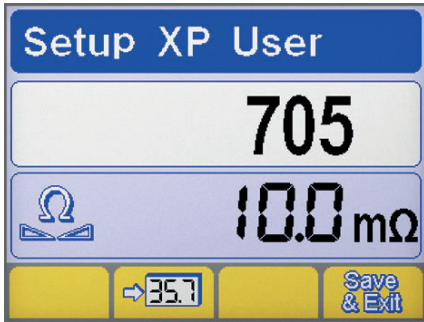

- ▶ Entrare nel set up premendo il tasto encoder per almeno 5 secondi.
- ▶ Selezionare il parametro desiderato (705).
- ▶ Attivare la regolazione del parametro selezionato premendo il tasto encoder.
- ▶ Collegare il generatore al circuito di saldatura (banco o pezzo).
- ▶ Togliere il cappuccio per mettere il tip porta ugello della torcia esposto. (MIG/MAG)

Taratura

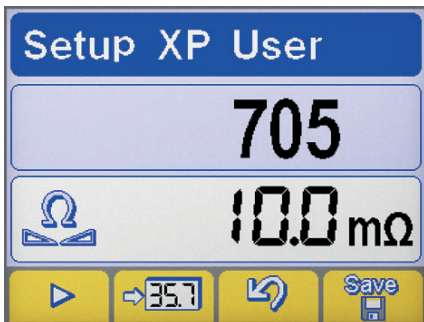

- ▶ Mettere in contatto elettrico la punta guidafile ed il pezzo da saldare. (MIG/MAG)
- ▶ Premere il pulsante **▶** per iniziare la procedura.
- ▶ Tenere il contatto per almeno un secondo.
- ▶ Il valore visualizzato a display si aggiornerà a taratura eseguita.
- ▶ Confermare l'operazione premendo il tasto **Save**.
- ▶ Annullare l'operazione premendo il tasto **↶**.
- ▶ Per salvare la modifica ed uscire dal set up premere il tasto: **Save & Exit**.

5.2.6 Limiti di guardia (Set up 801)

Permette l'impostazione dei limiti di attenzione e dei limiti di guardia.

Permette di controllare il processo di saldatura impostando sui principali parametri misurabili limiti di attenzione e limiti di guardia.

Consente il controllo accurato delle varie fasi di saldatura.

Limiti di attenzione		⚠ MIN	⚠ MAX	Limiti di guardia		⚠ MIN	⚠ MAX
	Corrente di saldatura				Tensione di saldatura		
	Letture di portata gas				Velocità di spostamento robot		
	Letture di corrente (motore 1)				Letture di corrente (motore 2)		
	Letture flusso liquido refrigerante				Letture velocità filo		
	Letture di temperatura liquido refrigerante						

Selezione parametro

- ▶ Entrare nel set up premendo il tasto encoder per almeno 5 secondi.
- ▶ Selezionare il parametro desiderato (801).
- ▶ Entrare nella schermata "Limiti di guardia" premendo il tasto encoder.

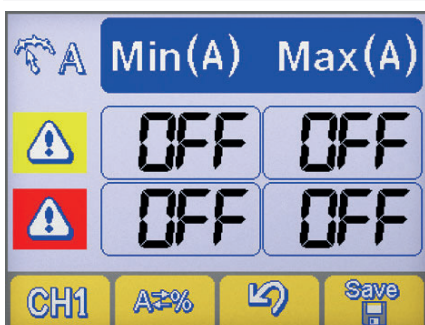
Selezione del parametro

- ▶ Selezionare il parametro desiderato premendo il tasto **CH1**.
- ▶ Selezionare la modalità d'impostazione dei limiti di guardia premendo il tasto **A=%**.

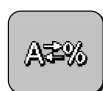
Selezione modalità

Valore assoluto

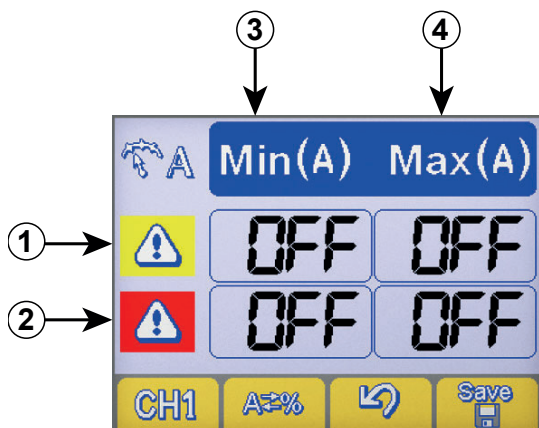

Valore percentuale

Impostazione limiti di guardia

- 1 Riga dei limiti di attenzione
- 2 Riga dei limiti di allarme
- 3 Colonna dei livelli minimi
- 4 Colonna dei livelli massimi

- ▶ Selezionare la casella desiderata premendo il tasto encoder (la casella selezionata viene visualizzata con contrasto invertito).
- ▶ Regolare il livello del limite selezionato ruotando l'encoder.
- ▶ Per salvare la modifica premere il pulsante: **Save**.



Il superamento di uno dei limiti di attenzione causa una segnalazione visiva sul pannello comandi.



Il superamento di uno dei limiti di allarme causa una segnalazione visiva sul pannello comandi e il blocco immediato delle operazioni di saldatura.



È consentito impostare dei filtri di inizio e fine saldatura per evitare segnalazioni di errore nelle fasi di innesco e di chiusura dell'arco (consultare sezione "Set up" - Parametri 802-803-804).

6. MANUTENZIONE



L'impianto deve essere sottoposto ad una manutenzione ordinaria secondo le indicazioni del costruttore. Tutti gli sportelli di accesso e servizio e i coperchi devono essere chiusi e ben fissati quando l'apparecchio è in funzione. L'impianto non deve essere sottoposto ad alcun tipo di modifica. Evitare che si accumuli polvere metallica in prossimità e sulle alette di areazione.



L'eventuale manutenzione deve essere eseguita esclusivamente da personale qualificato. La riparazione o la sostituzione di parti dell'impianto da parte di personale non autorizzato comporta l'immediata invalidazione della garanzia del prodotto. L'eventuale riparazione o sostituzione di parti dell'impianto deve essere eseguita esclusivamente da personale tecnico qualificato.



Togliere l'alimentazione all'impianto prima di ogni intervento!

6.1 Controlli periodici

6.1.1 Impianto



Effettuare la pulizia interna utilizzando aria compressa a bassa pressione e pennelli a setola morbida. Controllare le connessioni elettriche e tutti i cavi di collegamento.

6.1.2 Per la manutenzione o la sostituzione dei componenti delle torce, della pinza portaelettrodo e/o del cavo massa:



Controllare la temperatura dei componenti ed accertarsi che non siano surriscaldati.



Utilizzare sempre guanti a normativa.



Utilizzare chiavi ed attrezzi adeguati.

6.2 Responsabilità



In mancanza di detta manutenzione, decadranno tutte le garanzie e comunque il costruttore viene sollevato da qualsiasi responsabilità. Nel caso l'operatore non si attenesse a quanto descritto, il costruttore declina ogni responsabilità. Per ogni dubbio e/o problema non esitare a consultare il più vicino centro di assistenza tecnica.

7. CODIFICA ALLARMI



ALLARME

L'intervento di un allarme o il superamento di un limite di guardia critico causa una segnalazione visiva sul pannello comandi ed il blocco immediato delle operazioni di saldatura.



ATTENZIONE

L'intervento di un allarme o il superamento di un limite di guardia critico causa una segnalazione visiva sul pannello comandi ed il blocco immediato delle operazioni di saldatura.

Di seguito sono elencati tutti gli allarmi e i tutti i limiti di guardia relativi all'impianto.

	E01 Sovratemperatura	
--	----------------------	--

	E02 Sovratemperatura	
--	----------------------	--

	E03 Sovratemperatura	
--	----------------------	--

	E05 Sovracorrente	
--	-------------------	--

	E06 Sovracorrente modulo di potenza (Boost)	
--	---	--

	E07 Anomalia sistema di alimentazione del motore trainafilo	
--	---	--

 E08 Motore bloccato 	 E10 Sovracorrente modulo di potenza (Inverter) 
 E11 Errore configurazione impianto 	 E12 Errore di comunicazione (WF - DSP) 
 E13 Errore di comunicazione 	 E14 Programma non valido 
 E15 Programma non valido 	 E16 Errore di comunicazione (RI) (automazione e robotica) 
 E17 Errore di comunicazione (μP-DSP) 	 E18 Programma non valido 
 E19 Errore configurazione impianto 	 E20 Memoria guasta 
 E21 Perdita dati 	 E22 Errore di comunicazione (DSP) 
 E29 Misure incompatibili 	 E30 Errore di comunicazione (H.F.) 
 E32 Perdita dati 	 E38 Sottotensione 
 E39 Anomalia alimentazione impianto 	 E40 Anomalia alimentazione impianto 
 E43 Mancanza liquido refrigerante 	 E48 Mancanza filo (automazione e robotica) 
 E49 Interruttore di emergenza (automazione e robotica) 	 E50 Filo incollato (automazione e robotica) 
 E51 Impostazioni non supportate (automazione e robotica) 	 E52 Anti-collisione (automazione e robotica) 
 E53 Errore flussostato esterno (automazione e robotica) 	 E54 Livello di corrente superato (Limite inferiore) 
 E55 Livello di corrente superato (Limite superiore) 	 E56 Livello di tensione superato (Limite inferiore) 
 E57 Livello di tensione superato (Limite superiore) 	 E60 Limite di velocità superato (Limite inferiore) 
 E61 Limite di velocità superato (Limite superiore) 	 E62 Livello di corrente superato (Limite inferiore) 

E63	Livello di corrente superato (Limite superiore)	A ↑	E64	Livello di tensione superato (Limite inferiore)	V ↓
E65	Livello di tensione superato (Limite superiore)	V ↑	E68	Limite di velocità superato (Limite inferiore)	
E69	Limite di velocità superato (Limite superiore)		E70	Limiti di guardia impostati non compatibili	
E71	Sovratemperatura liquido refrigerante		E72	Sovracorrente motore push-pull	
E73	Limite velocità filo superato (speed meter)		E74	Livello di corrente motore 1 superato	A ϕ
E75	Livello di corrente motore 2 superato	A ϕ	E76	Livello di flusso liquido refrigerante superato	
E77	Livello di temperatura liquido refrigerante		E78	Manutenzione attiva (automazione e robotica)	

8. DIAGNOSTICA E SOLUZIONI

Mancata accensione dell'impianto (led verde spento)

Causa

- » Tensione di rete non presente sulla presa di alimentazione.
- » Spina o cavo di alimentazione difettoso.
- » Fusibile di linea bruciato.
- » Interruttore di accensione difettoso.
- » Collegamento tra carrello trainafile e generatore non corretto o difettoso.
- » Elettronica difettosa.

Soluzione

- » Eseguire una verifica e procedere alla riparazione dell'impianto elettrico.
- » Rivolgersi a personale specializzato.
- » Sostituire il componente danneggiato.
- » Rivolgersi al più vicino centro di assistenza per la riparazione dell'impianto.
- » Sostituire il componente danneggiato.
- » Sostituire il componente danneggiato.
- » Rivolgersi al più vicino centro di assistenza per la riparazione dell'impianto.
- » Verificare la corretta connessione delle parti dell'impianto.
- » Rivolgersi al più vicino centro di assistenza per la riparazione dell'impianto.

Assenza di potenza in uscita (l'impianto non salda)

Causa

- » Pulsante torcia difettoso.
- » Impianto surriscaldato (allarme termico - led giallo acceso).
- » Laterale aperto o switch porta difettoso.
- » Collegamento di massa non corretto.

Soluzione

- » Sostituire il componente danneggiato.
- » Rivolgersi al più vicino centro di assistenza per la riparazione dell'impianto.
- » Attendere il raffreddamento dell'impianto senza spegnere l'impianto.
- » È necessario per la sicurezza dell'operatore che il pannello laterale sia chiuso durante le fasi di saldatura.
- » Sostituire il componente danneggiato.
- » Rivolgersi al più vicino centro di assistenza per la riparazione dell'impianto.
- » Eseguire il corretto collegamento di massa.
- » Consultare il capitolo "Messa in servizio".

» Tensione di rete fuori range (led giallo acceso).

- » Riportare la tensione di rete entro il range di alimentazione del generatore.
- » Eseguire il corretto allacciamento dell'impianto.
- » Consultare il capitolo "Allacciamento".

» Elettronica difettosa.

- » Rivolgersi al più vicino centro di assistenza per la riparazione dell'impianto.

Erogazione di potenza non corretta

Causa

- » Errata selezione del processo di saldatura o selettore difettoso.
- » Errate impostazioni dei parametri e delle funzioni dell'impianto.
- » Potenzimetro/encoder per la regolazione della corrente di saldatura difettoso.
- » Tensione di rete fuori range.
- » Mancanza di una fase.
- » Elettronica difettosa.

Soluzione

- » Eseguire la corretta selezione del processo di saldatura.
- » Sostituire il componente danneggiato.
- » Rivolgersi al più vicino centro di assistenza per la riparazione dell'impianto.
- » Eseguire un reset dell'impianto e reimpostare i parametri di saldatura.
- » Sostituire il componente danneggiato.
- » Rivolgersi al più vicino centro di assistenza per la riparazione dell'impianto.
- » Eseguire il corretto allacciamento dell'impianto.
- » Consultare il capitolo "Allacciamento".
- » Eseguire il corretto allacciamento dell'impianto.
- » Consultare il capitolo "Allacciamento".
- » Rivolgersi al più vicino centro di assistenza per la riparazione dell'impianto.

Avanzamento filo bloccato

Causa

- » Pulsante torcia difettoso.
- » Rulli non corretti o consumati
- » Motoriduttore difettoso.
- » Guaina torcia danneggiata.
- » Trainafilo non alimentato
- » Avvolgimento irregolare su bobina.
- » Ugello torcia fuso (filo incollato)

Soluzione

- » Sostituire il componente danneggiato.
- » Rivolgersi al più vicino centro di assistenza per la riparazione dell'impianto.
- » Sostituire i rulli.
- » Sostituire il componente danneggiato.
- » Rivolgersi al più vicino centro di assistenza per la riparazione dell'impianto.
- » Sostituire il componente danneggiato.
- » Rivolgersi al più vicino centro di assistenza per la riparazione dell'impianto.
- » Verificare la connessione al generatore.
- » Consultare il capitolo "Allacciamento".
- » Rivolgersi al più vicino centro di assistenza per la riparazione dell'impianto.
- » Ripristinare le normali condizioni di svolgimento della bobina o sostituirla.
- » Sostituire il componente danneggiato.

Avanzamento filo non regolare

Causa

- » Pulsante torcia difettoso.
- » Rulli non corretti o consumati
- » Motoriduttore difettoso.
- » Guaina torcia danneggiata.

Soluzione

- » Sostituire il componente danneggiato.
- » Rivolgersi al più vicino centro di assistenza per la riparazione dell'impianto.
- » Sostituire i rulli.
- » Sostituire il componente danneggiato.
- » Rivolgersi al più vicino centro di assistenza per la riparazione dell'impianto.
- » Sostituire il componente danneggiato.
- » Rivolgersi al più vicino centro di assistenza per la riparazione dell'impianto.

» Frizione aspo o dispositivi di bloccaggio rulli regolati male.

» Allentare la frizione.
» Aumentare la pressione sui rulli.

Instabilità d'arco

Causa

» Protezione di gas insufficiente.

» Presenza di umidità nel gas di saldatura.

» Parametri di saldatura non corretti.

Soluzione

» Regolare il corretto flusso di gas.
» Verificare che diffusore e l'ugello gas della torcia siano in buone condizioni.

» Utilizzare sempre prodotti e materiali di qualità.
» Provvedere al mantenimento in perfette condizioni dell'impianto di alimentazione del gas.

» Eseguire un accurato controllo dell'impianto di saldatura.
» Rivolgersi al più vicino centro di assistenza per la riparazione dell'impianto.

Eccessiva proiezione di spruzzi

Causa

» Lunghezza d'arco non corretta.

» Parametri di saldatura non corretti.

» Protezione di gas insufficiente.

» Dinamica d'arco non corretta.

» Modalità di esecuzione della saldatura non corretta.

Soluzione

» Ridurre la distanza tra elettrodo e pezzo.
» Ridurre la tensione di saldatura.

» Ridurre la corrente di saldatura.

» Regolare il corretto flusso di gas.
» Verificare che diffusore e l'ugello gas della torcia siano in buone condizioni.

» Aumentare il valore induttivo del circuito.
» Utilizzare una presa induttiva maggiore.

» Ridurre l'inclinazione della torcia.

Insufficiente penetrazione

Causa

» Modalità di esecuzione della saldatura non corretta.

» Parametri di saldatura non corretti.

» Elettrodo non corretto.

» Preparazione dei lembi non corretta.

» Collegamento di massa non corretto.

» Pezzi da saldare di consistenti dimensioni.

Soluzione

» Ridurre la velocità di avanzamento in saldatura.

» Aumentare la corrente di saldatura.

» Utilizzare un elettrodo di diametro inferiore.

» Aumentare l'apertura del cianfrino.

» Eseguire il corretto collegamento di massa.
» Consultare il capitolo "Messa in servizio".

» Aumentare la corrente di saldatura.

Inclusioni di scoria

Causa

» Incompleta asportazione della scoria.

» Elettrodo di diametro troppo grosso.

» Preparazione dei lembi non corretta.

» Modalità di esecuzione della saldatura non corretta.

Soluzione

» Eseguire una accurata pulizia dei pezzi prima di eseguire la saldatura.

» Utilizzare un elettrodo di diametro inferiore.

» Aumentare l'apertura del cianfrino.

» Ridurre la distanza tra elettrodo e pezzo.
» Avanzare regolarmente durante tutte le fasi della saldatura.

Inclusioni di tungsteno

Causa

» Parametri di saldatura non corretti.

» Elettrodo non corretto.

Soluzione

» Ridurre la corrente di saldatura.
» Utilizzare un elettrodo di diametro superiore.

» Utilizzare sempre prodotti e materiali di qualità.
» Eseguire una corretta affilatura dell'elettrodo.

» Modalità di esecuzione della saldatura non corretta.

» Evitare contatti tra elettrodo e bagno di saldatura.

Soffiature

Causa

» Protezione di gas insufficiente.

Soluzione

» Regolare il corretto flusso di gas.
 » Verificare che diffusore e l'ugello gas della torcia siano in buone condizioni.

Incollature

Causa

» Lunghezza d'arco non corretta.

Soluzione

» Aumentare la distanza tra elettrodo e pezzo.
 » Aumentare la tensione di saldatura.

» Parametri di saldatura non corretti.

» Aumentare la corrente di saldatura.
 » Aumentare la tensione di saldatura.

» Modalità di esecuzione della saldatura non corretta.

» Angolare maggiormente l'inclinazione della torcia.

» Pezzi da saldare di consistenti dimensioni.

» Aumentare la corrente di saldatura.

» Dinamica d'arco non corretta.

» Aumentare il valore induttivo del circuito.
 » Utilizzare una presa induttiva maggiore.

Incisioni marginali

Causa

» Parametri di saldatura non corretti.

Soluzione

» Ridurre la corrente di saldatura.
 » Utilizzare un elettrodo di diametro inferiore.

» Lunghezza d'arco non corretta.

» Ridurre la distanza tra elettrodo e pezzo.
 » Ridurre la tensione di saldatura.

» Modalità di esecuzione della saldatura non corretta.

» Ridurre la velocità di oscillazione laterale nel riempimento.
 » Ridurre la velocità di avanzamento in saldatura.

» Protezione di gas insufficiente.

» Utilizzare gas adatti ai materiali da saldare.

Ossidazioni

Causa

» Protezione di gas insufficiente.

Soluzione

» Regolare il corretto flusso di gas.
 » Verificare che diffusore e l'ugello gas della torcia siano in buone condizioni.

Porosità

Causa

» Presenza di grasso, vernice, ruggine o sporcizia sui pezzi da saldare.

Soluzione

» Eseguire una accurata pulizia dei pezzi prima di eseguire la saldatura.

» Presenza di grasso, vernice, ruggine o sporcizia sul materiale d'apporto.

» Utilizzare sempre prodotti e materiali di qualità.
 » Mantenere sempre in perfette condizioni il materiale d'apporto.

» Presenza di umidità nel materiale d'apporto.

» Utilizzare sempre prodotti e materiali di qualità.
 » Mantenere sempre in perfette condizioni il materiale d'apporto.

» Lunghezza d'arco non corretta.

» Ridurre la distanza tra elettrodo e pezzo.
 » Ridurre la tensione di saldatura.

» Presenza di umidità nel gas di saldatura.

» Utilizzare sempre prodotti e materiali di qualità.
 » Provvedere al mantenimento in perfette condizioni dell'impianto di alimentazione del gas.

» Protezione di gas insufficiente.

» Regolare il corretto flusso di gas.
 » Verificare che diffusore e l'ugello gas della torcia siano in buone condizioni.

» Solidificazione del bagno di saldatura troppo rapida.

» Ridurre la velocità di avanzamento in saldatura.
 » Eseguire un preriscaldamento dei pezzi da saldare.
 » Aumentare la corrente di saldatura.

Cricche a caldo

Causa

- » Parametri di saldatura non corretti.
- » Presenza di grasso, vernice, ruggine o sporcizia sui pezzi da saldare.
- » Presenza di grasso, vernice, ruggine o sporcizia sul materiale d'apporto.
- » Modalità di esecuzione della saldatura non corretta.
- » Pezzi da saldare con caratteristiche dissimili.

Soluzione

- » Ridurre la corrente di saldatura.
- » Utilizzare un elettrodo di diametro inferiore.
- » Eseguire una accurata pulizia dei pezzi prima di eseguire la saldatura.
- » Utilizzare sempre prodotti e materiali di qualità.
- » Mantenere sempre in perfette condizioni il materiale d'apporto.
- » Eseguire le corrette sequenze operative per il tipo di giunto da saldare.
- » Eseguire una imburratura prima di realizzare la saldatura.

Cricche a freddo

Causa

- » Presenza di umidità nel materiale d'apporto.
- » Geometria particolare del giunto da saldare.

Soluzione

- » Utilizzare sempre prodotti e materiali di qualità.
- » Mantenere sempre in perfette condizioni il materiale d'apporto.
- » Eseguire un preriscaldamento dei pezzi da saldare.
- » Eseguire un postriscaldamento.
- » Eseguire le corrette sequenze operative per il tipo di giunto da saldare.

9. CENNI TEORICI SULLA SALDATURA

9.1 Saldatura con elettrodo rivestito (MMA)

Preparazione dei lembi

Per ottenere buone saldature è sempre consigliabile operare su parti pulite, libere da ossido, ruggine o altri agenti contaminanti.

Scelta dell'elettrodo

Il diametro dell'elettrodo da impiegare dipende dallo spessore del materiale, dalla posizione, dal tipo di giunto e dal tipo di cianfrino. Elettrodi di grosso diametro richiedono correnti elevate con conseguente elevato apporto termico nella saldatura.

Tipo di rivestimento	Proprietà	Impiego
Rutilo	Facilità d'impiego	Tutte le posizioni
Acido	Alta velocità fusione	Piano
Basico	Caratt. meccaniche	Tutte le posizioni

Scelta della corrente di saldatura

Il range della corrente di saldatura relativa al tipo di elettrodo impiegato viene specificato dal costruttore sul contenitore stesso degli elettrodi.

Accensione e mantenimento dell'arco

L'arco elettrico si stabilisce sfregando la punta dell'elettrodo sul pezzo da saldare collegato al cavo massa e, una volta scoccato l'arco, ritraendo rapidamente la bacchetta fino alla distanza di normale saldatura.

Per migliorare l'accensione dell'arco è utile, in generale, un incremento iniziale di corrente rispetto alla corrente base di saldatura (Hot Start). Una volta instauratosi l'arco elettrico inizia la fusione della parte centrale dell'elettrodo che si deposita sotto forma di gocce sul pezzo da saldare. Il rivestimento esterno dell'elettrodo fornisce, consumandosi, il gas protettivo per la saldatura che risulta così di buona qualità. Per evitare che le gocce di materiale fuso, cortocircuitando l'elettrodo col bagno di saldatura, a causa di un accidentale avvicinamento tra i due, provochino lo spegnimento dell'arco è molto utile un momentaneo aumento della corrente di saldatura fino al termine del cortocircuito (Arc Force). Nel caso in cui l'elettrodo rimanga incollato al pezzo da saldare è utile ridurre al minimo la corrente di cortocircuito (anti-sticking).

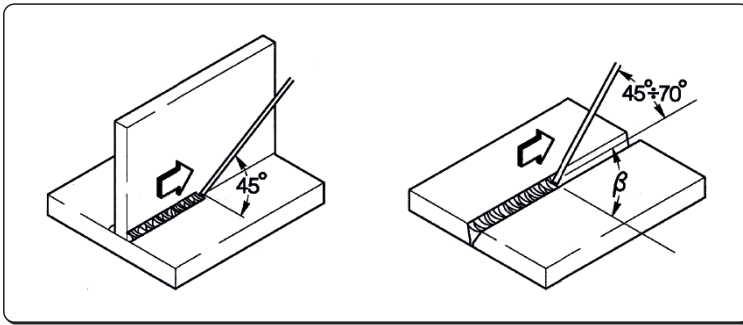

Esecuzione della saldatura

L'angolo di inclinazione dell'elettrodo varia a seconda del numero delle passate, il movimento dell'elettrodo viene eseguito normalmente con oscillazioni e fermate ai lati del cordone in modo da evitare un accumulo eccessivo di materiale d'apporto al centro.

Asportazione della scoria

La saldatura mediante elettrodi rivestiti impone l'asportazione della scoria successivamente ad ogni passata. L'asportazione viene effettuata mediante un piccolo martello o attraverso la spazzolatura nel caso di scoria friabile.

9.2 Saldatura TIG (arco continuo)

Descrizione

Il procedimento di saldatura TIG (Tungsten Inert Gas) basa i suoi principi su di un arco elettrico che scocca tra un elettrodo infusibile (tungsteno puro o legato, avente temperatura di fusione a circa 3370°C) ed il pezzo; una atmosfera di gas inerte (Argon) provvede alla protezione del bagno. Per evitare pericolose inclusioni di tungsteno nel giunto l'elettrodo non deve mai venire a contatto con il pezzo da saldare, per questo motivo si crea tramite un generatore H.F. una scarica che permette l'innesco a distanza dell'arco elettrico. Esiste anche un altro tipo di partenza, con inclusioni di tungsteno ridotte: la partenza in lift, che non prevede alta frequenza ma una situazione iniziale di corto circuito a bassa corrente tra l'elettrodo e il pezzo; nel momento in cui si solleva l'elettrodo si instaura l'arco e la corrente aumenta fino al valore di saldatura impostato. Per migliorare la qualità della parte finale del cordone di saldatura è utile poter controllare con precisione la discesa della corrente di saldatura ed è necessario che il gas fluisca nel bagno di saldatura per alcuni secondi dopo l'estinzione dell'arco. In molte condizioni operative è utile poter disporre di 2 correnti di saldatura preimpostate e di poter passare facilmente da una all'altra (BILEVEL).

Polarità di saldatura

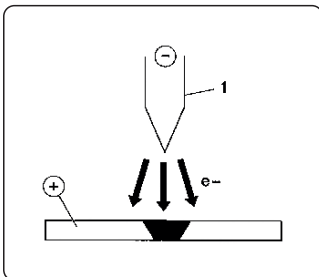

D.C.S.P. (Direct Current Straight Polarity)

È la polarità più usata (polarità diretta), consente una limitata usura dell'elettrodo in quanto il 70% del calore si concentra sull'anodo (pezzo).

Si ottengono bagni stretti e profondi con elevate velocità di avanzamento e, conseguentemente, basso apporto termico.

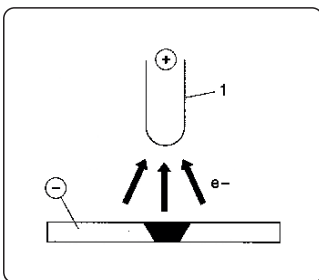

D.C.R.P. (Direct Current Reverse Polarity)

La polarità è inversa e consente la saldatura di leghe ricoperte da uno strato di ossido refrattario con temperatura di fusione superiore a quella del metallo.

Non si possono usare elevate correnti in quanto provocherebbero una elevata usura dell'elettrodo.

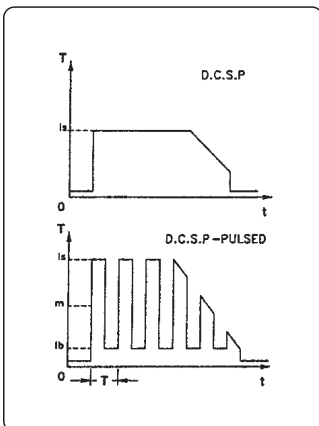

D.C.S.P.-Pulsed (Direct Current Straight Polarity Pulsed)

L'adozione di una corrente continua pulsata permette un miglior controllo del bagno di saldatura in particolari condizioni operative.

Il bagno di saldatura viene formato dagli impulsi di picco (I_p), mentre la corrente di base (I_b) mantiene l'arco acceso; questo facilita la saldatura di piccoli spessori con minori deformazioni, migliore fattore di forma e conseguente minor pericolo di cricche a caldo e di inclusioni gassose.

Con l'aumentare della frequenza (media frequenza) si ottiene un arco più stretto, più concentrato e più stabile ed una ulteriore maggiore qualità della saldatura di spessori sottili.

Saldature TIG degli acciai

Il procedimento TIG risulta molto efficace nella saldatura degli acciai sia al carbonio che legati, per la prima passata sui tubi e nelle saldature che debbono presentare ottimo aspetto estetico. È richiesta la polarità diretta (D.C.S.P.).

Preparazione dei lembi

Il procedimento richiede un'attenta pulizia dei lembi e una loro accurata preparazione.

Scelta e preparazione dell'elettrodo

Si consiglia l'uso di elettrodi di tungsteno toriato (2% di torio-colorazione rossa) o in alternativa elettrodi ceriati o lantaniati con i seguenti diametri:

Ø elettrodo	Gamma di corrente
1.0 mm	15÷75 A
1.6 mm	60÷150 A
2.4 mm	130÷240 A

L'elettrodo va appuntito come indicato in figura.

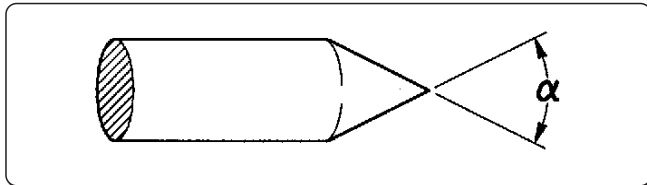

α°	Gamma di corrente
30	0÷30 A
60÷90	30÷120 A
90÷120	120÷250 A

Materiale d'apporto

Le bacchette d'apporto devono possedere proprietà meccaniche paragonabili a quelle del materiale base.

È sconsigliato l'uso di strisce ricavate dal materiale base, in quanto possono contenere impurità dovute alla lavorazione, tali da compromettere le saldature.

Gas di protezione

Praticamente viene usato sempre argon puro (99.99%).

Corrente di saldatura	Ø elettrodo	Ugello gas n°	Ugello gas	Flusso Argon
30 A	0÷30 mm	4/5	6/8.0 mm	5-6 l/min
60÷90 A	30÷120 mm	4/5/6	6.5/8.0/9.5 mm	6-7 l/min
90÷120 A	120÷250 mm	6/7	9.5/11.0 mm	7-8 l/min

Saldatura TIG del rame

Essendo il TIG un procedimento ad alta concentrazione termica, risulta particolarmente indicato nella saldatura di materiali ad elevata conducibilità termica come il rame.

Per la saldatura TIG del rame seguire le stesse indicazioni della saldatura TIG degli acciai o testi specifici.

9.3 Saldatura a filo continuo (MIG/MAG)

Introduzione

Un sistema MIG è formato da un generatore in corrente continua, un alimentatore e una bobina di filo, una torcia e gas.

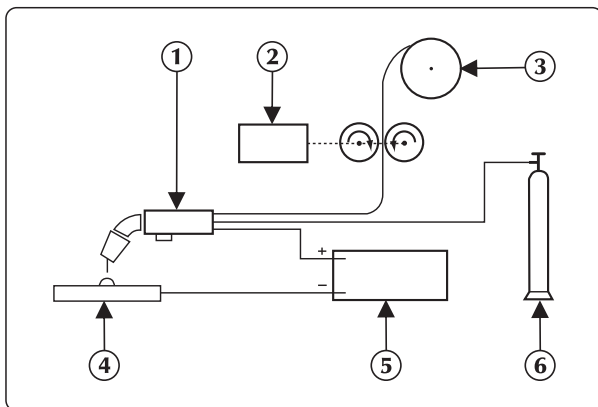

Impianto di saldatura manuale

La corrente viene trasferita all'arco attraverso l'elettrodo fusibile (filo posto a polarità positiva);

In questo procedimento il metallo fuso è trasferito sul pezzo da saldare attraverso l'arco.

L'alimentazione del filo è resa necessaria per reintegrare il filo d'apporto fuso durante la saldatura.

Metodi di procedimento

Nella saldatura sotto protezione di gas, le modalità secondo cui le gocce si staccano dall'elettrodo definiscono due sistemi di trasferimento.

Un primo metodo definito "TRASFERIMENTO A CORTO CIRCUITO (SHORT-ARC)", fa entrare l'elettrodo a contatto diretto con il bagno, si fa quindi un cortocircuito con effetto fusibile da parte del filo che si interrompe, dopo di che l'arco si riaccende ed il ciclo si ripete.

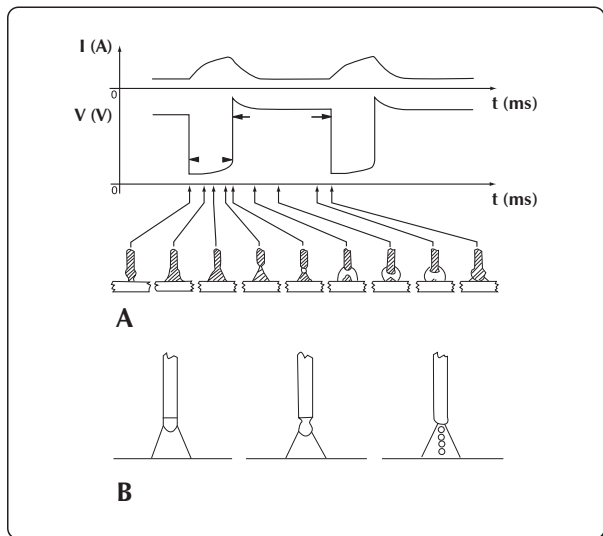

Ciclo SHORT e saldatura SPRAY ARC

Un altro metodo per ottenere il trasferimento delle gocce è il cosiddetto "TRASFERIMENTO A SPRUZZO (SPRAY-ARC)", che consente alle gocce di staccarsi dall'elettrodo e in un secondo tempo giungono nel bagno di fusione.

Parametri di saldatura

La visibilità dell'arco riduce la necessità di una rigida osservanza delle tabelle di regolazione da parte dell'operatore che ha la possibilità di controllare direttamente il bagno di fusione.

- La tensione influenza direttamente l'aspetto del cordone, ma le dimensioni della superficie saldata possono essere variate a seconda delle esigenze, agendo manualmente sul movimento della torcia in modo da ottenere depositi variabili con tensione costante.
- La velocità di avanzamento del filo è in relazione con la corrente di saldatura.

Nelle due figure seguenti vengono mostrate le relazioni che sussistono tra i vari parametri di saldatura.



Tabella orientativa di guida per la scelta dei parametri di saldatura riferita alle applicazioni più tipiche e ai fili di più comune impiego

IT

Tensione d'arco	Ø 0,8 mm	Ø 1,0-1,2 mm	Ø 1,6 mm	Ø 2,4 mm
16V - 22V SHORT - ARC				
	60 - 160 A Bassa penetrazione per piccoli spessori	100 - 175 A Buon controllo della penetrazione e della fusione	120 - 180 A Buona fusione in piano e in verticale	150 - 200 A Non impiegato
24V - 28V SEMI SHORT-ARC (Zona di transizione)				
	150 - 250 A Saldatura automatica d'angolo	200 - 300 A Saldatura automatica a tensione alta	250 - 350 A Saldatura automatica discendente	300 - 400 A Non impiegato
30V - 45V SPRAY - ARC				
	150 - 250 A Bassa penetrazione, regolazione a 200 A	200 - 350 A Saldatura automatica a passate multiple	300 - 500 A Buona penetrazione in discendente	500 - 750 A Buona penetrazione alto deposito su grossi spessori

Gas utilizzabili

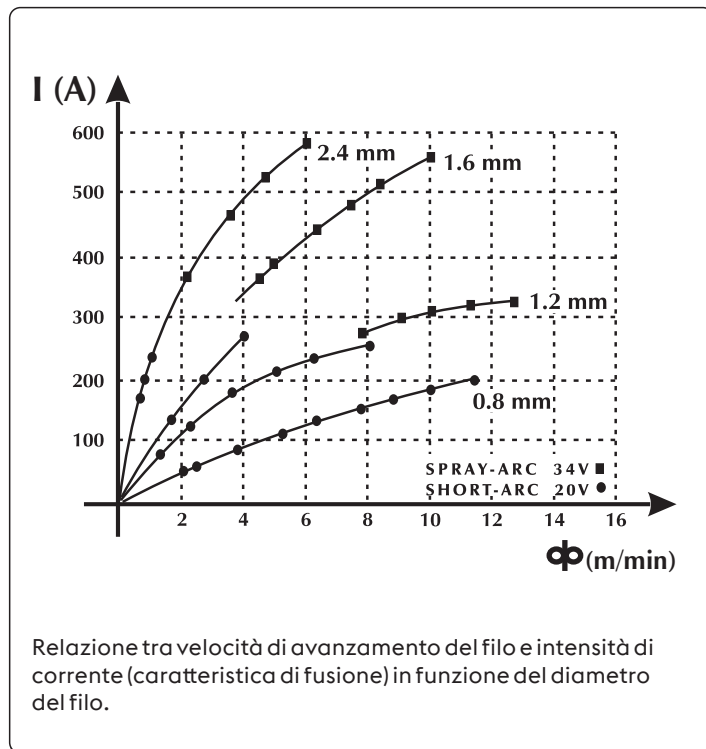
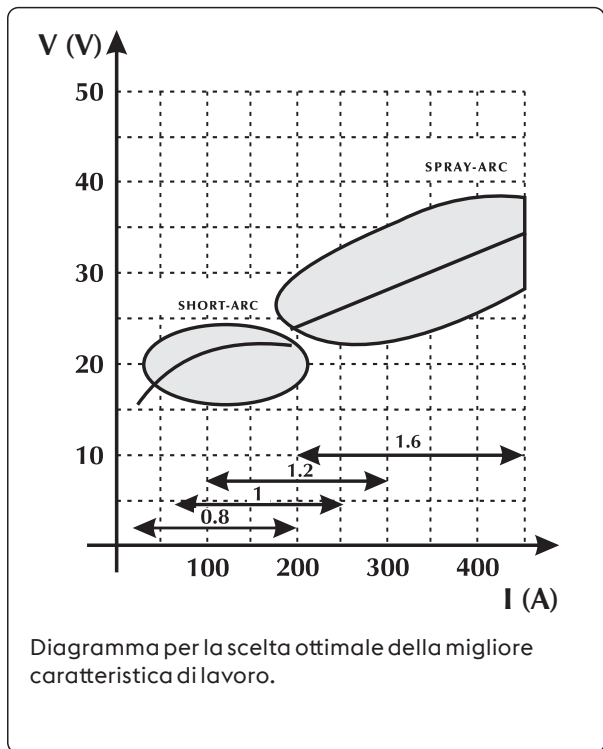
La saldatura MIG-MAG è caratterizzata principalmente dal tipo di gas utilizzato, inerte per la saldatura MIG (Metal Inert Gas), attivo nella saldatura MAG (Metal Active Gas).

- Anidride carbonica (CO₂)

Utilizzando CO₂ come gas di protezione si ottengono elevate penetrazioni con elevata velocità di avanzamento e buone proprietà meccaniche unitamente ad un basso costo di esercizio. Ciò nonostante l'uso di questo gas crea notevoli problemi sulla composizione chimica finale dei giunti in quanto vi è una perdita di elementi facilmente ossidabili e, contemporaneamente si ha un arricchimento di carbonio del bagno. La saldatura con CO₂ pura dà anche altri tipi di problemi come l'eccessiva presenza di spruzzi e la formazione di porosità da ossido di carbonio.

- Argon

Questo gas inerte viene usato puro nella saldatura delle leghe leggere mentre per la saldatura di acciai inossidabili al cromo-nichel si preferisce lavorare con l'aggiunta di ossigeno e CO₂ in percentuale 2%, questo contribuisce alla stabilità dell'arco e alla migliore forma del cordone.

- Elio

Questo gas si utilizza in alternativa all'argon e consente maggiori penetrazioni (su grandi spessori) e maggiori velocità di avanzamento.

- Miscela Argon-Elio

Si ottiene un arco più stabile rispetto all'elio puro, una maggiore penetrazione e velocità rispetto all'argon.

- Miscela Argon-CO₂ e Argon-CO₂-Ossigeno

Queste miscele vengono impiegate nella saldatura dei materiali ferrosi soprattutto in condizioni di SHORT-ARC in quanto migliora l'apporto termico specifico. Questo non ne esclude l'uso in SPRAY-ARC.

Normalmente la miscela contiene una percentuale di CO₂ che va dall'8% al 20% e O₂ intorno al 5%. Consultare il manuale d'uso dell'impianto.

10. CARATTERISTICHE TECNICHE

Caratteristiche elettriche			U.M.
Tensione di alimentazione U1 (50/60 Hz)	3x230 (±15%)	3x400 (±15%)	Vac
Zmax (@PCC)*	62	62	mΩ
Fusibile linea ritardato	30	20	A
Tipo di comunicazione	DIGITALE	DIGITALE	
Potenza massima assorbita	13.3	13.0	kVA
Potenza massima assorbita	12.8	12.4	kW
Potenza assorbita in stato inattivo	71	71	W
Fattore di potenza (PF)	0.96	0.95	
Rendimento (μ)	85	85	%
Cos φ	0.99	0.99	
Corrente massima assorbita I1max	32.9	18.8	A
Corrente effettiva I1eff	20.8	13.3	A
Gamma di regolazione (MMA)	3-320	3-320	A
Tensione a vuoto Uo	75	75	Vdc

* Questa apparecchiatura è conforme ai requisiti della normativa EN / IEC 61000-3-11.

* Questa apparecchiatura è conforme ai requisiti della normativa EN / IEC 61000-3-12 se la massima impedenza di rete ammessa al punto di interfacciamento con la rete pubblica (punto di accoppiamento comune - point of common coupling, PCC) è inferiore o uguale al valore Zmax dichiarato. Se l'apparecchiatura è connessa alla rete pubblica a bassa tensione, è responsabilità dell'installatore o dell'utilizzatore assicurarsi, con l'eventuale consultazione del gestore della rete se necessario, che l'apparecchiatura possa essere connessa.

Fattore di utilizzo	3x230V	3x400V	U.M.
Fattore di utilizzo MMA (40°C)			
(X=35%)	320	-	A
(X=50%)	-	320	A
(X=60%)	270	300	A
(X=100%)	230	250	A
Fattore di utilizzo MMA (25°C)			
(X=60%)	320	320	A
(X=100%)	270	270	A
Fattore di utilizzo TIG (40°C)			
(X=45%)	320	-	A
(X=60%)	300	320	A
(X=100%)	250	270	A
Fattore di utilizzo TIG (25°C)			
(X=70%)	320	320	A
(X=100%)	270	270	A
Fattore di utilizzo MIG/MAG (40°C)			
(X=35%)	320	-	A
(X=50%)	-	320	A
(X=60%)	280	310	A
(X=100%)	230	250	A
Fattore di utilizzo MIG/MAG (25°C)			
(X=60%)	320	-	A
(X=70%)	-	320	A
(X=100%)	270	270	A

Caratteristiche fisiche			U.M.
Grado di protezione IP	IP23S		
Classe isolamento	H		
Dimensioni (lxwxh)	620x240x460		mm
Peso	26.7		Kg
Norme di costruzione	EN IEC 60974-1/A1:2019 EN IEC 60974-3:2019 EN 60974-10/A1:2015		
Sezione cavo di alimentazione	4x4		mm ²
Lunghezza cavo di alimentazione	5		m

11. TARGA DATI

VOESTALPINE BÖHLER WELDING SELCO S.R.L. Via Palladio, 19 - ONARA (PADOVA) - ITALY			
URANOS NX 3200 PME		N°	
3A/20.0V - 320A (320A)/32.8V (32.8V)			
X (40°C) 50% (35%) 60% 100%			
S	U ₀	I ₂	320A (320A) 300A (270A) 250A (230A)
	75V	U ₂	32.8V (32.8V) 32.0V (30.8V) 30.0V (29.2V)
3A/10.0V - 320A (320A)/22.8V (22.8V)			
X (40°C) (45%) 60% 100%			
S	U ₀	I ₂	(320A) 320A (300A) 270A (250A)
	75V	U ₂	(22.8V) 22.8V (22.0V) 20.8V (20.0V)
3A/14.0V - 320A (320A)/30.0V (30.0V)			
X (40°C) 50% (35%) 60% 100%			
S	U ₀	I ₂	320A (320A) 310A (280A) 250A (230A)
	75V	U ₂	30.0V (30.0V) 29.5V (28.5V) 26.5V (25.5V)
U ₁ 400V(230V)		I _{lmax} 18.8A(32.9A)	I _{leff} 13.3A(20.8A)
IP 23 S			

12. SIGNIFICATO TARGA DATI

1		2					
3		4					
5		6					
7	9	23					
		11					
8	10	12	15	16	17		
		13	15A	16A	17A		
		14	15B	16B	17B		
7	9	11					
		11					
8	10	12	15	16	17		
		13	15A	16A	17A		
		14	15B	16B	17B		
18		19		20		21	
22							

- 1 Marchio di fabbricazione
- 2 Nome ed indirizzo del costruttore
- 3 Modello dell'apparecchiatura
- 4 N° di serie
X**XX**XXXXXXXXXX Anno di fabbricazione
- 5 Simbolo del tipo di saldatrice
- 6 Riferimento alle norme di costruzione
- 7 Simbolo del processo di saldatura
- 8 Simbolo per le saldatrici idonee a lavorare in un ambiente a rischio accresciuto di scossa elettrica
- 9 Simbolo della corrente di saldatura
- 10 Tensione nominale a vuoto
- 11 Gamma della corrente nominale di saldatura massima e minima e della corrispondente tensione convenzionale di carico
- 12 Simbolo del ciclo di intermittenza
- 13 Simbolo della corrente nominale di saldatura
- 14 Simbolo della tensione nominale di saldatura
- 15 Valori del ciclo di intermittenza
- 16 Valori del ciclo di intermittenza
- 17 Valori del ciclo di intermittenza
- 15A Valori della corrente nominale di saldatura
- 16A Valori della corrente nominale di saldatura
- 17A Valori della corrente nominale di saldatura
- 15B Valori della tensione convenzionale di carico
- 16B Valori della tensione convenzionale di carico
- 17B Valori della tensione convenzionale di carico
- 18 Simbolo per l'alimentazione
- 19 Tensione nominale d'alimentazione
- 20 Massima corrente nominale d'alimentazione
- 21 Massima corrente efficace d'alimentazione
- 22 Grado di protezione
- 23 Tensione nominale di picco

CE Dichiarazione di conformità EU
 EAC Dichiarazione di conformità EAC
 UKCA Dichiarazione di conformità UKCA

EU DECLARATION OF CONFORMITY

The builder

voestalpine Böhler Welding Selco S.r.l. - Via Palladio, 19 - 35019 Onara di Tombolo (PD) - ITALY
Tel. +39 049 9413/111 - Fax +39 049 9413/311 - www.voestalpine.com/welding

EN

declares under its sole responsibility that the following product:

URANOS NX 3200 PME	55.03.066
	55.03.070

conforms to the EU directives:

2014/35/EU LOW VOLTAGE DIRECTIVE
2014/30/EU EMC DIRECTIVE
2011/65/EU RoHS DIRECTIVE

and that following harmonized standards have been duly applied:

EN IEC 60974-1/A1:2019	WELDING POWER SOURCE
EN 60974-10/A1:2015	ELECTROMAGNETIC COMPATIBILITY REQUIREMENTS

The documentation certifying compliance with the directives will be kept available for inspection at the aforementioned manufacturer.

Any operation or modification that has not been previously authorized by voestalpine Böhler Welding Selco S.r.l. will invalidate this certificate.

Onara di Tombolo, 15/10/2021

voestalpine Böhler Welding Selco s.r.l.

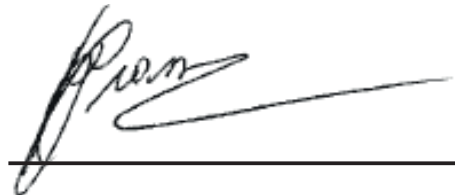

Lino Frasson

INDEX

1. WARNING	50
1.1 Work environment.....	50
1.2 User's and other persons' protection.....	50
1.3 Protection against fumes and gases.....	51
1.4 Fire/explosion prevention.....	51
1.5 Prevention when using gas cylinders.....	52
1.6 Protection from electrical shock.....	52
1.7 Electromagnetic fields and interferences.....	52
1.8 IP Protection rating.....	53
1.9 Disposal.....	53
2. INSTALLATION	54
2.1 Lifting, transport & unloading.....	54
2.2 Positioning of the equipment.....	54
2.3 Connection.....	54
2.4 Installation.....	55
3. SYSTEM PRESENTATION	57
3.1 Rear panel.....	57
3.2 Sockets panel.....	57
3.3 Front control panel.....	57
3.4 Front control panel.....	58
4. EQUIPMENT USE	59
4.1 Starting Screen.....	59
4.2 Test screen.....	59
4.3 Main Screen.....	60
4.4 MMA process main screen.....	60
5. SETUP	67
5.1 Parameter set up and setting.....	67
5.2 Specific procedures parameters.....	76
6. MAINTENANCE	81
6.1 Carry out the following periodic checks on the power source.....	81
6.2 Responsibility.....	81
7. Alarm codes	81
8. TROUBLESHOOTING	83
9. WELDING THEORY	87
9.1 Manual Metal Arc welding (MMA).....	87
9.2 TIG welding (continuous arc).....	87
9.3 Continuous wire welding (MIG/MAG).....	89
10. TECHNICAL SPECIFICATIONS	92
11. RATING PLATE	93
12. MEANING RATING PLATE	93
13. DIAGRAM	557
14. CONNECTORS	559
15. SPARE PARTS LIST	560

SYMBOLS



Imminent danger of serious body harm and dangerous behaviours that may lead to serious body harm.



Important advice to be followed in order to avoid minor injuries or damage to property.



Technical notes to facilitate operations.

1. WARNING



Before performing any operation on the machine, make sure that you have thoroughly read and understood the contents of this booklet. Do not perform modifications or maintenance operations which are not prescribed. Do consult qualified personnel for any doubt or problem concerning the use of the machine, even if not described herein.

Do not perform modifications or maintenance operations which are not prescribed. The manufacturer cannot be held responsible for damages to persons or property caused by misuse or non-application of the contents of this booklet by the user.

The operating instructions must always be at hand wherever the device is being used. In addition to the operating instructions, attention must also be paid to any generally applicable and local regulations regarding accident prevention and environmental protection.



All persons involved in commissioning, operating, maintaining and servicing the device must:

- be suitably qualified
- have sufficient knowledge of welding
- read and follow these operating instructions carefully

Please consult qualified personnel if you have any doubts or difficulties in using the equipment.

1.1 Work environment



All equipment shall be used exclusively for the operations for which it was designed, in the ways and ranges stated on the rating plate and/or in this booklet, according to the national and international directives regarding safety. Other uses than the one expressly declared by the manufacturer shall be considered totally inappropriate and dangerous and in this case the manufacturer disclaims all responsibility.



This unit must be used for professional applications only, in industrial environments. The manufacturer will accept no responsibility for any damages caused by use in domestic environments.



The equipment must be used in environments with a temperature between -10°C and +40°C (between +14°F and +104°F).

The equipment must be transported and stored in environments with a temperature between -25°C and +55°C (between -13°F and 131°F).

The equipment must be used in environments free from dust, acid, gas or any other corrosive substances.

The equipment shall not be used in environments with a relative humidity higher than 50% at 40°C (104°F).

The equipment shall not be used in environments with a relative humidity higher than 90% at 20°C (68°F).

The system must not be used at an higher altitude than 2,000 metres (6,500 feet) above sea level.



Do not use this machine to defrost pipes.

Do not use this equipment to charge batteries and/or accumulators.

Do not use this equipment to jump-start engines.

1.2 User's and other persons' protection



The welding process is a noxious source of radiation, noise, heat and gas emissions. Position a fire-retardant shield to protect the surrounding welding area from rays, sparks and incandescent slags. Advise any person in the area of welding not to stare at the arc or at the incandescent metal and to get an adequate protection.



Wear protective clothing to protect your skin from the arc rays, sparks or incandescent metal. Clothes must cover the whole body and must be:

- intact and in good conditions
- fireproof
- insulating and dry
- well-fitting and without cuffs or turn-ups



Always use regulation shoes that are strong and ensure insulation from water.

Always use regulation gloves ensuring electrical and thermal insulation.



Wear masks with side face guards and a suitable protection filter (at least NR10 or above) for the eyes.



Always wear safety goggles with side guards, especially during the manual or mechanical removal of welding slag.



Do not wear contact lenses!



Use headphones if dangerous noise levels are reached during the welding. If the noise level exceeds the limits prescribed by law, delimit the work area and make sure that anyone getting near it is protected with headphones or earphones.



Always keep the side covers closed while welding. Avoid your hands, hair, clothes, tools ... coming into contact with moving parts such as: fans, gears, rollers and shafts, wire reels. Do not touch gears while the wire feed unit is working. The system must not be modified in any way. Bypassing the protection devices fitted on wire feed units is extremely dangerous and releases the manufacturer from any responsibility in respect of damages to either people or property.



While loading and feeding the wire, keep your head away from the MIG/MAG torch. The wire that is coming out can seriously damage your hands, face and eyes.



Avoid touching items that have just been welded: the heat could cause serious burning or scorching. Follow all the precautions described above also in all operations carried out after welding since slag may detach from the items while they are cooling off.



Check that the torch is cold before working on or maintaining it.



Ensure the cooling unit is switched off before disconnecting the pipes of the cooling liquid. The hot liquid coming out of the pipes might cause burning or scorching.



Keep a first aid kit ready for use. Do not underestimate any burning or injury.



Before leaving work, make the area safe, in order to avoid accidental damage to people or property.

1.3 Protection against fumes and gases



Fumes, gases and powders produced during the welding process can be noxious for your health. Under certain circumstances, the fumes caused by welding can cause cancer or harm the foetus of pregnant women.

- Keep your head away from any welding gas and fumes.
- Provide proper ventilation, either natural or forced, in the work area.
- In case of poor ventilation, use masks and breathing apparatus.
- In case of welding in extremely small places the work should be supervised by a colleague standing nearby outside.
- Do not use oxygen for ventilation.
- Ensure that the fumes extractor is working by regularly checking the quantity of harmful exhaust gases versus the values stated in the safety regulations.
- The quantity and the danger level of the fumes depends on the parent metal used, the filler metal and on any substances used to clean and degrease the pieces to be welded. Follow the manufacturer's instructions together with the instructions given in the technical sheets.
- Do not perform welding operations near degreasing or painting stations.
- Position gas cylinders outdoors or in places with good ventilation.

1.4 Fire/explosion prevention



The welding process may cause fires and/or explosions.

- Clear the work area and the surrounding area from any flammable or combustible materials or objects.
- Flammable materials must be at least 11 metres (35 feet) from the welding area or they must be suitably protected.
- Sparks and incandescent particles might easily be sprayed quite far and reach the surrounding areas even through minute openings. Pay particular attention to keep people and property safe.
- Do not perform welding operations on or near containers under pressure.
- Do not perform welding or cutting operations on closed containers or pipes. Pay particular attention during welding operations on pipes or containers even if these are open, empty and have been cleaned thoroughly. Any residue of gas, fuel, oil or similar materials might cause an explosion.
- Do not weld in places where explosive powders, gases or vapours are present.
- When you finish welding, check that the live circuit cannot accidentally come in contact with any parts connected to the earth circuit.
- Position a fire-fighting device or material near the work area.

1.5 Prevention when using gas cylinders



Inert gas cylinders contain pressurized gas and can explode if the minimum safe conditions for transport, storage and use are not ensured.

- Cylinders must be secured in a vertical position to a wall or other supporting structure, with suitable means so that they cannot fall or accidentally hit anything else.
- Screw the cap on to protect the valve during transport, commissioning and at the end of any welding operation.
- Do not expose cylinders to direct sunlight, sudden changes of temperature, too high or extreme temperatures. Do not expose cylinders to temperatures too low or too high.
- Keep cylinders away from naked flames, electric arcs, torches or electrode guns and incandescent material sprayed by welding.
- Keep cylinders away from welding circuits and electrical circuits in general.
- Keep your head away from the gas outlet when opening the cylinder valve.
- Always close the cylinder valve at the end of the welding operations.
- Never perform welding operations on a pressurized gas cylinder.
- A compressed air cylinder must never be directly coupled to the machine pressure reducer! Pressure might exceed the capacity of the reducer which could consequently explode!

1.6 Protection from electrical shock



Electric shocks can kill you.

- Avoid touching live parts both inside and outside the welding system while this is active (torches, guns, earth cables, electrodes, wires, rollers and spools are electrically connected to the welding circuit).
- Make sure that the welding system and the welder are electrically isolated by using dry bases and floors that are adequately isolated from earth.
- Ensure the system is connected correctly to a socket and a power source equipped with an earth conductor.
- Do not touch two torches or two electrode holders at the same time.
- If you feel an electric shock, interrupt the welding operations immediately.

1.7 Electromagnetic fields and interferences



The current passing through the internal and external system cables creates an electromagnetic field in the proximity of the welding cables and the equipment itself.

- Electromagnetic fields can affect the health of people who are exposed to them for a long time (the exact effects are still unknown).
- Electromagnetic fields can interfere with some equipment like pacemakers or hearing aids.



Persons fitted with pacemakers must consult their doctor before undertaking arc welding operations.

1.7.1 EMC classification in accordance with: EN 60974-10/A1:2015.



Class B equipment complies with electromagnetic compatibility requirements in industrial and residential environments, including residential locations where the electrical power is provided by the public low-voltage supply system.



Class A equipment is not intended for use in residential locations where the electrical power is provided by the public low-voltage supply system. There may be potential difficulties in ensuring electromagnetic compatibility of class A equipment in those locations, due to conducted as well as radiated disturbances.

For more informations, check the chapter: RATING PLATE or TECHNICAL SPECIFICATIONS.

1.7.2 Installation, use and area examination

This equipment is manufactured in compliance with the requirements of the harmonized standard EN 60974-10/A1:2015 and is identified as "CLASS A" equipment. This unit must be used for professional applications only, in industrial environments. The manufacturer will accept no responsibility for any damages caused by use in domestic environments.



The user must be an expert in the activity and as such is responsible for installation and use of the equipment according to the manufacturer's instructions. If any electromagnetic interference is noticed, the user must solve the problem, if necessary with the manufacturer's technical assistance.



In any case electromagnetic interference problems must be reduced until they are not a nuisance any longer.



Before installing this apparatus, the user must evaluate the potential electromagnetic problems that may arise in the surrounding area, considering in particular the health conditions of the persons in the vicinity, for example of persons fitted with pacemakers or hearing aids.

1.7.3 Mains power supply requirements

High power equipment may, due to the primary current drawn from the mains supply, influence the power quality of the grid. Therefore connection restrictions or requirements regarding the maximum permissible mains impedance (Z_{max}) or the required minimum supply capacity (S_{sc}) at the interface point to the public grid (point of common coupling, PCC) may apply for some types of equipment (see technical data). In this case it is the responsibility of the installer or user of the equipment to ensure, by consultation with the distribution network operator if necessary, that the equipment may be connected. In case of interference, it may be necessary to take further precautions like the filtering of the mains power supply.

It is also necessary to consider the possibility of shielding the power supply cable.

For more informations, check the chapter: TECHNICAL SPECIFICATIONS.

1.7.4 Precautions regarding cables

To minimise the effects of electromagnetic fields follow the following instructions:

- Where possible, collect and secure the earth and power cables together.
- Never coil the cables around your body.
- Do not place your body in between the earth and power cables (keep both on the same side).
- The cables must be kept as short as possible, positioned as close as possible to each other and laid at or approximately at ground level.
- Position the equipment at some distance from the welding area.
- The cables must be kept away from any other cables.

1.7.5 Earthing connection

The earth connection of all the metal components in the welding (cutting) equipment and in the close area must be taken in consideration. The earthing connection must be made according to the local regulations.

1.7.6 Earthing the workpiece

When the workpiece is not earthed for electrical safety reasons or due to its size and position, the earthing of the workpiece may reduce the emissions. It is important to remember that the earthing of the workpiece should neither increase the risk of accidents for the user nor damage other electric equipment. The earthing must be made according to the local regulations.

1.7.7 Shielding

The selective shielding of other cables and equipment present in the surrounding area may reduce the problems due to electromagnetic interference.

The shielding of the entire welding equipment can be taken in considered for special applications.

1.8 IP Protection rating



IP23S

- Enclosure protected against access to dangerous parts by fingers and against ingress of solid bodies objects with diameter equal or greater than 12.5 mm.
- Enclosure protected against rain at an angle of 60°.
- Enclosure protected against harmful effects due to the ingress of water when the moving parts of the equipment are not operating.

1.9 Disposal



Do not dispose of electrical equipment together with normal waste!

In conformity to European Directive 2012/19/EU on Waste Electrical and Electronic Equipment and to its implementation according to national law, at the end of its life cycle, electrical equipment must be collected separately and disposed of through an authorised recovery and disposal centre. The owner of the equipment is required to identify authorised collection centres on the basis of the information provided by Local Authorities. By applying this European Directive you will improve the environment and human health!

2. INSTALLATION



Installation should be performed only by expert personnel authorised by the manufacturer.



During installation, ensure that the power source is disconnected from the mains.



The multiple connection of power sources (series or parallel) is prohibited.

2.1 Lifting, transport & unloading

- The equipment is provided with a handle for hand transportation.
- The equipment is not equipped with specific lifting elements.
- Use a fork lift truck paying attention during operations in order to prevent the generator from tipping over.



Do not underestimate the weight of the equipment: see technical specifications.
Do not move or position the suspended load above persons or things.
Do not drop or apply undue pressure on the equipment.

2.2 Positioning of the equipment



Keep to the following rules:

- Provide easy access to the equipment controls and connections.
- Do not position the equipment in very small spaces.
- Do not place the equipment on surfaces with inclination exceeding 10° from to the horizontal plane.
- Position the equipment in a dry, clean and suitably ventilated place.
- Protect the equipment against pouring rain and sun.

2.3 Connection

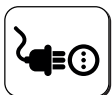

The equipment is provided with a power supply cable for connection to the mains.
The system can be powered by:

- three-phase 400V
- three-phase 230V

Operation of the equipment is guaranteed for voltage tolerances up to $\pm 15\%$ with respect to the rated value.



To prevent injury to persons or damage to the equipment, the selected mains voltage and fuses must be checked **BEFORE** connecting the machine to the mains. Also check that the cable is connected to a socket provided with earth contact.



The equipment can be powered by a generating set guarantees a stable power supply voltage of $\pm 15\%$ with respect to the rated voltage value declared by the manufacturer, under all possible operating conditions and at the maximum rated power. Normally we recommend the use of generating sets with twice rated power of a single phase power source or 1.5 times that of a three-phase power source. The use of electronic control type generating sets is recommended.



In order to protect users, the equipment must be correctly earthed. The power supply voltage is provided with an earth lead (yellow - green), which must be connected to a plug provided with earth contact. This yellow/green wire shall **NEVER** be used with other voltage conductors. Verify the existence of the earthing in the equipment used and the good condition of the sockets. Install only certified plugs according to the safety regulations.



The electrical connections must be made by skilled technicians with the specific professional and technical qualifications and in compliance with the regulations in force in the country where the equipment is installed.

2.4 Installation

2.4.1 Connection for MMA welding



The connection shown in the figure produces reverse polarity welding. To obtain straight polarity welding, reverse the connection.

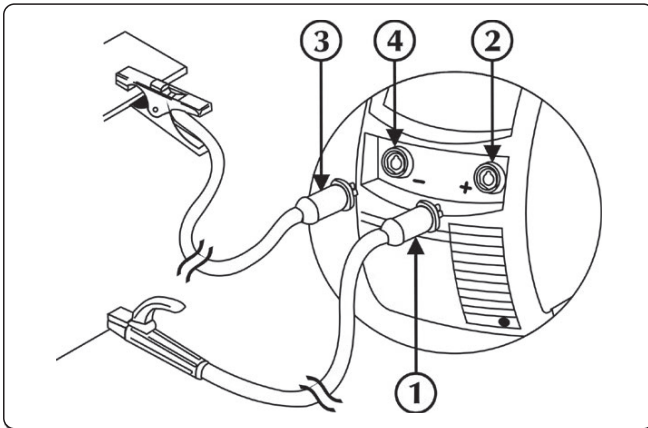

- ① Earth clamp connector
- ② Negative power socket (-)
- ③ Electrode holder clamp connector
- ④ Positive power socket (+)

- ▶ Connect the earth clamp to the negative socket (-) of the power source. Insert the plug and turn clockwise until all parts are secured.
- ▶ Connect the electrode holder to the positive socket (+) of the power source. Insert the plug and turn clockwise until all parts are secured.

2.4.2 Connection for TIG welding

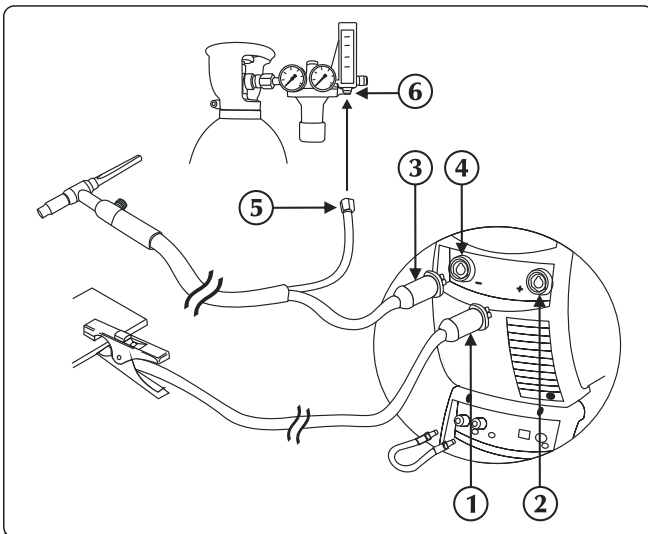



- ① Earth clamp connector
- ② Positive power socket (+)
- ③ TIG torch fitting
- ④ Torch socket
- ⑤ Gas pipe connector
- ⑥ Pressure reducer

- ▶ Connect the earth clamp to the positive socket (+) of the power source. Insert the plug and turn clockwise until all parts are secured.
- ▶ Connect the TIG torch coupling to the torch socket of the power source. Insert the plug and turn clockwise until all parts are secured.





The protection gas flow can be adjusted using the tap normally found on the torch.

- ▶ Separately connect the torch gas hose connector to the gas main.
- ▶ Connect the water pipe (red coloured) of the torch to the inlet quick connector (red coloured - symbol ) of the cooling unit.
- ▶ Connect the water pipe (blue coloured) of the torch to the outlet quick connector (blue coloured - symbol ) of the cooling unit.

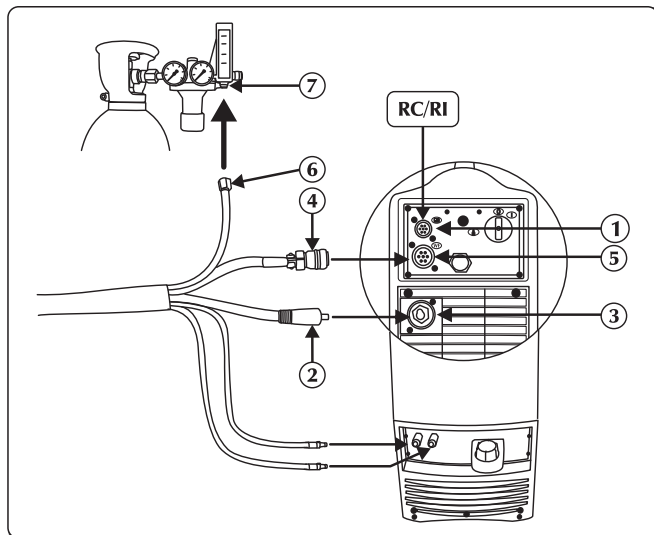
2.4.3 Connection for MIG/MAG welding



- ① Signal cable (CAN-BUS) input
- ② Power cable
- ③ Positive power socket (+)
- ④ Signal cable
- ⑤ Signal cable input (CAN bus) (cable bundle)
- ⑥ Gas tube
- ⑦ Gas supply connector

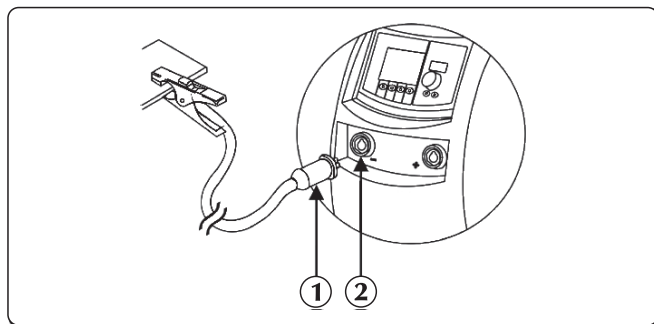

- ▶ Connect the power cable to the appropriate outlet. Insert the plug and turn clockwise until all parts are secured.
- ▶ Connect the signal cable to the appropriate connector. Insert the connector and rotate the ring nut clockwise until the parts are properly secured.
- ▶ Connect the gas hose to the pressure reducing valve of the cylinder or to the gas supply connection. Adjust the gas flow from 10 to 30 l/min.
- ▶ Connect the water pipe (blue coloured) to the outlet quick connector (blue coloured - symbol ) of the cooling unit.
- ▶ Connect the water pipe (red coloured) to the inlet quick connector (red coloured - symbol ) of the cooling unit.

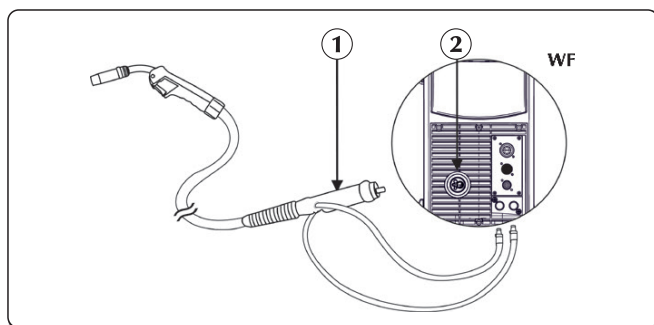

- ① Earth clamp connector
- ② Negative power socket (-)
- ▶ Connect the earth clamp to the negative socket (-) of the power source. Insert the plug and turn clockwise until all parts are secured.



- ① Torch fitting
- ② Connector

- ▶ Connect the water pipe (blue coloured) of the torch to the outlet quick connector (blue coloured - symbol ) of the cooling unit.
- ▶ Connect the water pipe (red coloured) of the torch to the inlet quick connector (red coloured - symbol ) of the cooling unit.
- ▶ Connect the MIG/MAG torch to the central adapter, ensuring that the fastening ring is fully tightened.

3. SYSTEM PRESENTATION

3.1 Rear panel

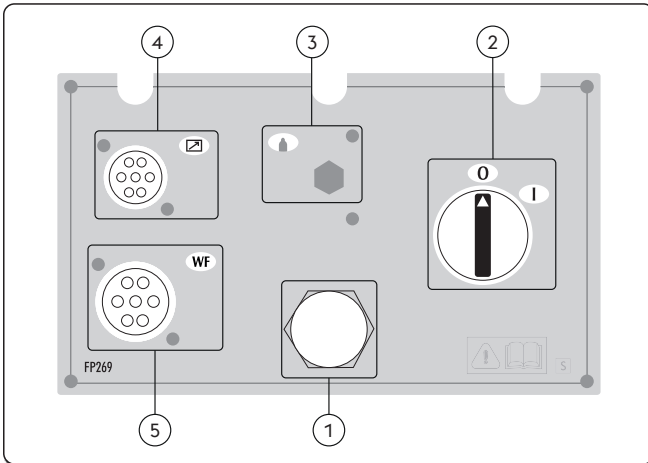

- ① **Power supply cable**
Connects the system to the mains.
- ② **Off/On switch**
Turns on the electric power to the welder. It has two positions, "0" off, and "I" on.
- ③ **Not used**
- ④ **Signal cable CAN-BUS input (RC, RI...)**
- ⑤ **Signal cable input (CAN bus) (cable bundle)**

3.2 Sockets panel

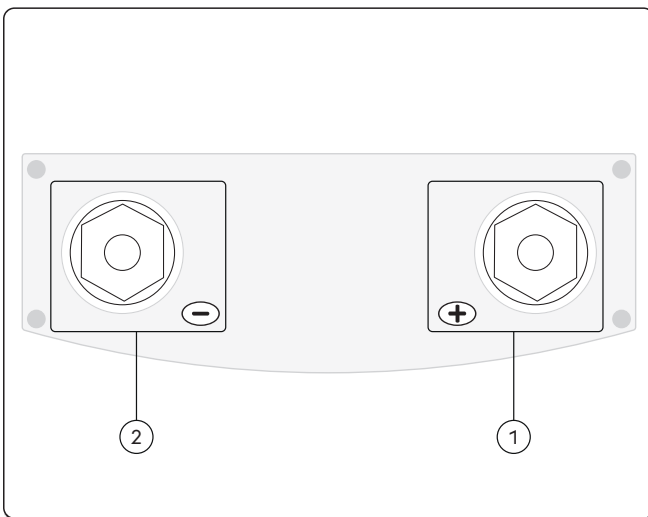

- ① **Positive power socket (+)**
Process MMA: Connection electrode torch
Process TIG: Connection earth cable
- ② **Negative power socket (-)**
Process MMA: Connection earth cable
Process TIG: Connection torch
MIG/MAG process: Connection earth cable



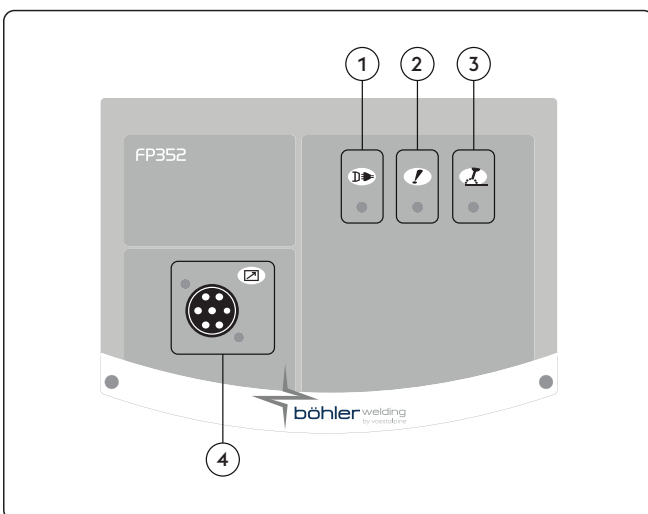



3.3 Front control panel

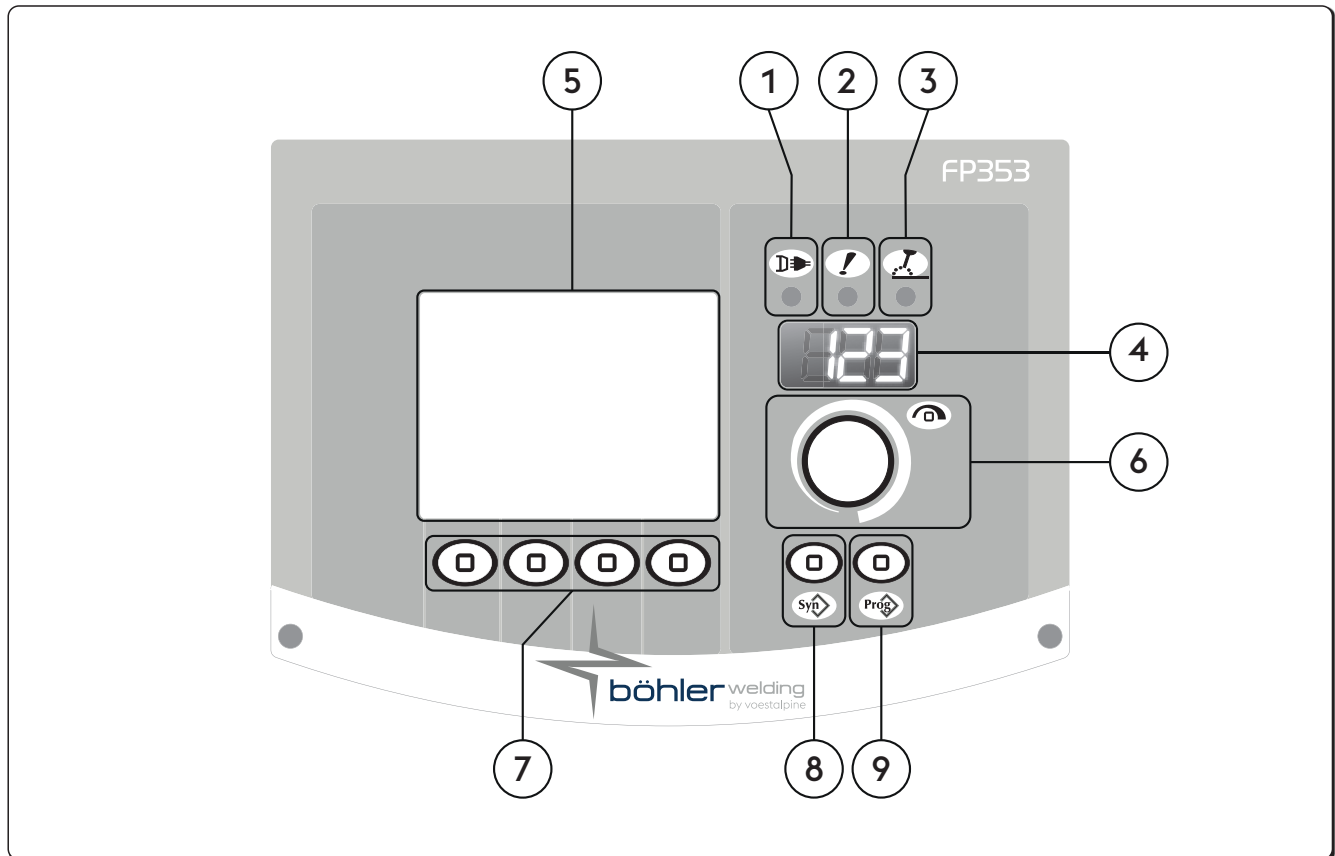

- ① **Power supply LED**
Indicates that the equipment is connected to the mains and is on.
- ② **General alarm LED**
Indicates the possible intervention of protection devices such as the temperature protection.
- ③ **Power on LED**
Indicates the presence of voltage on the equipment outlet connections.
- ④ **Signal cable CAN-BUS input (RC, RI...)**

3.4 Front control panel



- ①  **Power supply LED**
Indicates that the equipment is connected to the mains and is on.
- ②  **General alarm LED**
Indicates the possible intervention of protection devices such as the temperature protection.
- ③  **Power on LED**
Indicates the presence of voltage on the equipment outlet connections.
- ④  **7-segment display**
Allows the general welding machine parameters to be displayed during start-up, settings, current and voltage readings, while welding, and encoding of the alarms.
- ⑤  **LCD display**
Allows the general welding machine parameters to be displayed during start-up, settings, current and voltage readings, while welding, and encoding of the alarms.
Allows all the operations to be displayed instantaneously.
- ⑥  **Main adjustment handle.**
Allows entry to set up, the selection and the setting of the welding parameters.
- ⑦  **Function keys**
Let you select the various system functions:
 - MMA welding process
 - Welding methods
 - Current pulsation
 - Graphic mode

8



Program key

Lets you select a preset welding program by choosing a few simple settings:

- Wire type
- Type of gas
- Wire diameter

9



Job key

Allows the storage and management of 240 welding programs which can be personalised by the operator.

4. EQUIPMENT USE

4.1 Starting Screen

When switched on, the generator performs a succession of checks in order to guarantee the correct operation of the system and of all the devices connected to it. At this stage the gas test is also carried out to check the proper connection to the gas supply system.

4.2 Test screen

When the side panel (coil compartment) is open, the welding operations are inhibited. The test screen appears on the LCD display.

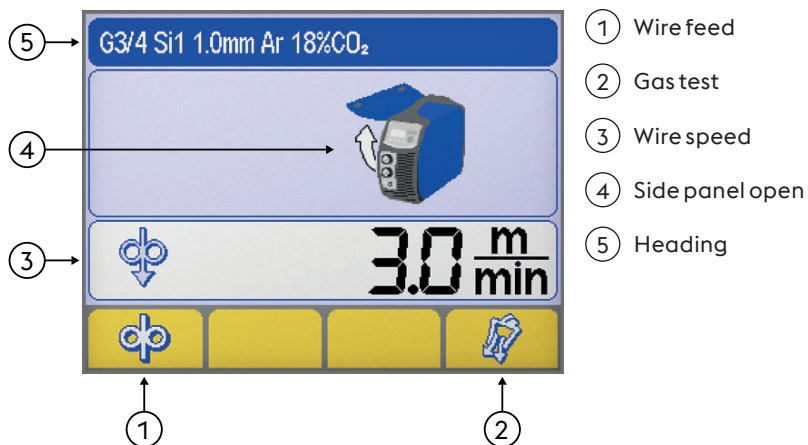

Wire feed

Allows the manual wire feed without gas flow and without the wire live. Allows the insertion of the wire into the torch sheath during the welding preparation phases.



Gas test

Allows the gas circuit to be cleansed of impurities and the carrying out of the appropriate preliminary gas pressure and flow adjustments, without power on.



Wire speed

It allow wire speed regulation (during wire loading phase).

Minimum	Maximum	Default
0.5 m/min	22.0 m/min	3.0 m/min



Side panel open



Heading

Allows the display of certain pieces of important information relating to the selected process.

EN

4.3 Main Screen

Allows the control of the system and of the welding process, showing the main settings.

4.4 MMA process main screen

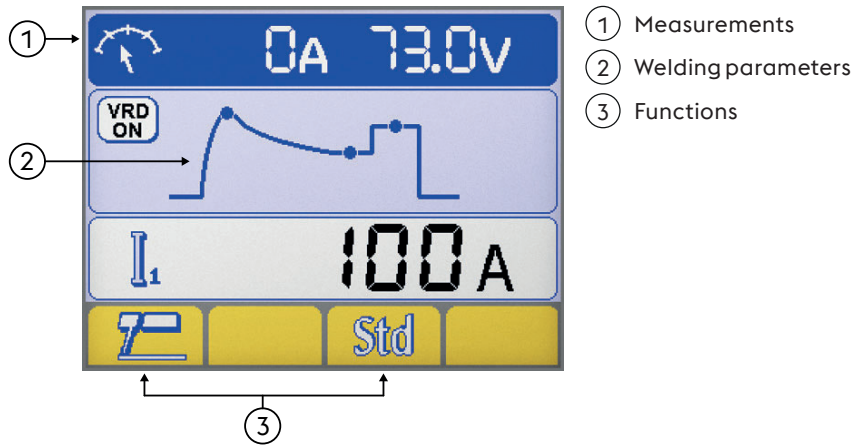

- ① Measurements
- ② Welding parameters
- ③ Functions

Measurements

During the welding operation, the real current and voltage measurements are shown on the LCD display.

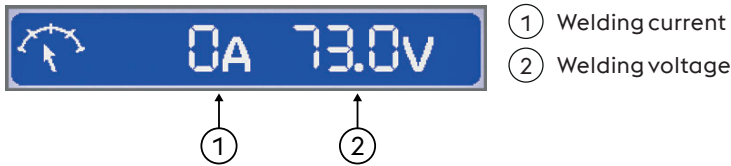

- ① Welding current
- ② Welding voltage

Welding parameters

► Select the required parameter by pressing the encoder button.

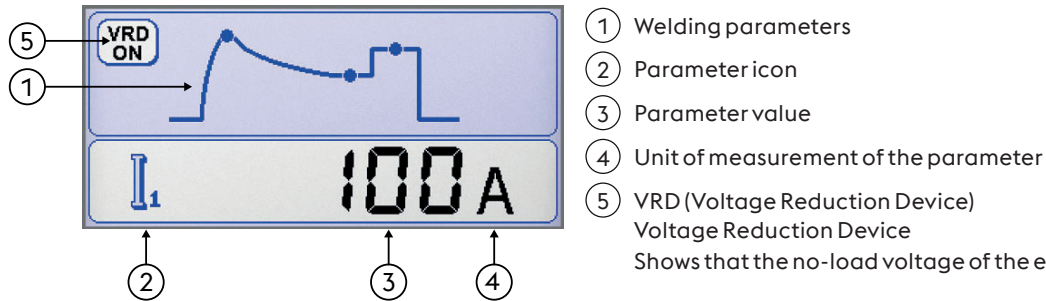

- ① Welding parameters
- ② Parameter icon
- ③ Parameter value
- ④ Unit of measurement of the parameter
- ⑤ VRD (Voltage Reduction Device)
Voltage Reduction Device
Shows that the no-load voltage of the equipment is controlled.

Functions

Allow the setting of the most important process functions and welding methods.



- ① MMA welding process
- ② MMA synergy



EN



MMA synergy

Allows you to set the best arc dynamics, selecting the type of electrode used.

Selecting the correct arc dynamics enables maximum benefit to be derived from the power source to achieve the best possible welding performances.

Standard (Basic/Rutile)	Cellulosic	Steel	Aluminum	Cast irons



Perfect weldability of the electrode used is not guaranteed
Weldability depends on the quality of the consumables and their conservation, on the operating methods and on the welding conditions, on the numerous possible applications.

4.5 TIG process main screen

- ① Measurements
- ② Welding parameters
- ③ Functions

Measurements

During the welding operation, the real current and voltage measurements are shown on the LCD display.

- ① Welding current
- ② Welding voltage

Welding parameters

- ① Welding parameters
 - ▶ Select the required parameter by pressing the encoder button.
 - ▶ Adjust the value of the selected parameter by rotating the encoder.
- ② Parameter icon
- ③ Parameter value
- ④ Unit of measurement of the parameter

Functions

Allow the setting of the most important process functions and welding methods.

- ① MMA welding process



4.6 MIG/MAG process main screen

Basic screen

① Heading MIG/MAG
② Welding parameters
③ Functions

Graphic screen

① Heading MIG/MAG
② Welding parameters
③ Functions

Heading MIG/MAG

Allows the display of certain pieces of important information relating to the selected process.

① Type of filler metal
② Wire diameter
③ Type of gas

Synergic curve selected

- ① Type of filler metal
- ② Wire diameter
- ③ Type of gas

① Welding current
② Workpiece thickness
③ Corner bead
④ Welding voltage

Welding parameters

- ① Welding current
- ② Workpiece thickness
- ③ Corner bead
- ④ Welding voltage

Welding parameters (Basic screen)

▶ Select the required parameter by pressing the encoder button.

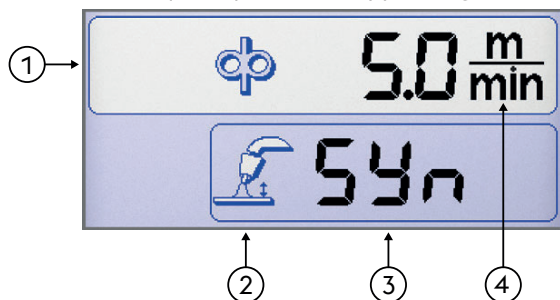

- ① Welding parameters
- ② Parameter icon
- ③ Parameter value
- ④ Unit of measurement of the parameter

Welding parameters (Graphic screen)

▶ Select the required parameter by pressing the encoder button.

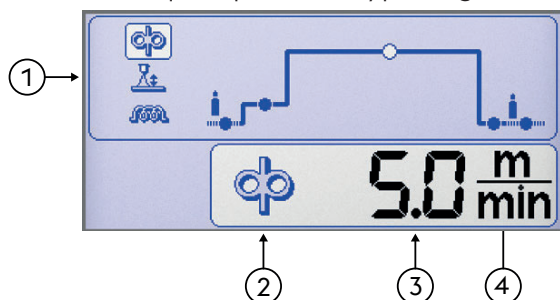

- ① Welding parameters
- ② Parameter icon
- ③ Parameter value
- ④ Unit of measurement of the parameter

Functions

Allow the setting of the most important process functions and welding methods.

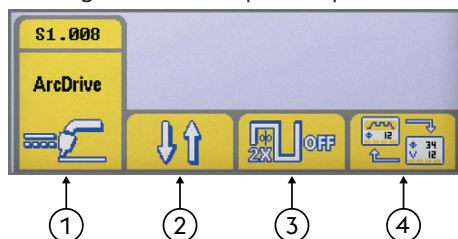

- ① MMA welding process
- ② Welding methods
- ③ Double Pulsed MIG welding
- ④ Screen



MMA welding process



Welding methods

Allows the selection of the welding method



2 Step

In two step, pressing the button causes the gas to flow, feeds voltage to the wire and makes it advance; when it is released, the gas, the voltage and the wire feed are turned off.



4 Step

In four step first pressure on the button causes the gas to flow with a manual pre-gas time; releasing it activates the voltage to the wire and its feed. The following pressure on the button stops the wire and causes the final process to start which brings the current back to zero; finally releasing the button turns off the gas flow.



Crater filler

Allows welding to be done with three different power levels able to be directly selected and controlled by the welder using the torch button.

The first pressure on the button causes the gas to flow, activates the voltage to the wire and feeds it at the speed set by the "initial increment" parameter (during set up) and with the relative synergic values of the welding parameters.

When the torch button is released, the wire speed and the relative synergic parameters change automatically to the main values set on the control panel.

The next pressure on the torch button brings the wire speed and the relative synergic parameters to the pre-set (during set up) crater filler parameter values.

Releasing the torch button stops the wire feed and supplies the power for the burn back and post-gas stages.

EN



Double Pulsed MIG welding



Double pulsed inactive



Double pulsed active

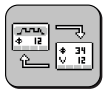

Screen

Permits view changes between:



Basic screen



Graphic screen

Synergic curves screen



Synergy

Lets you select a preset welding program (synergy) by choosing a few simple settings

Welding process selection

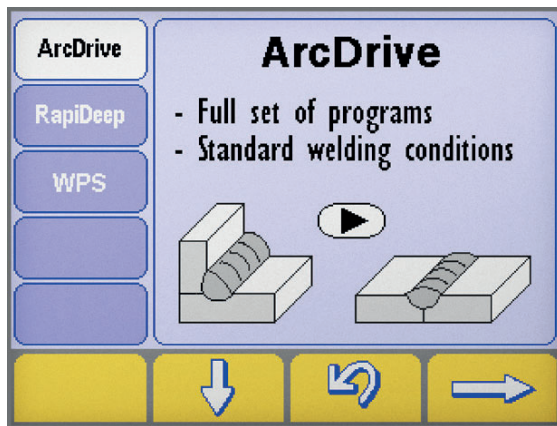

- ▶ Enter the "Synergy" menu by pressing the key for at least a second.
- ▶ Press the relevant keys to select the required process and .
- ▶ Press the button to go to the next step.

MMA welding process



Material type/Gas type synergy selection screen

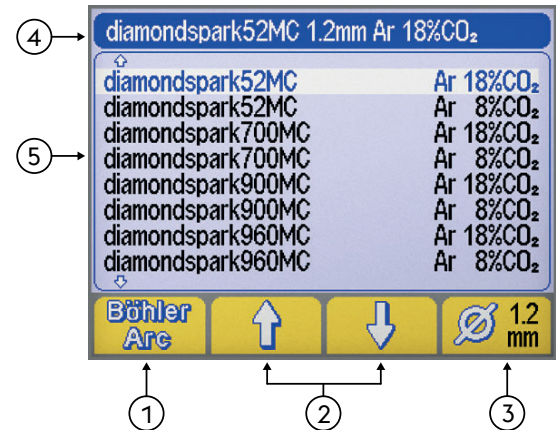

- ① Welding program (BöhlerArc/UniversalArc)
- ② Material/gas selection
- ③ Wire diameter
- ④ Heading
- ⑤ Welding program



Welding program

Allows the selection of the welding program



BöhlerArc



UniversalArc



Material/gas selection

Lets you select:



- Type of filler metal
- Type of gas



Wire diameter

Allows selection of the wire diameter used (mm).

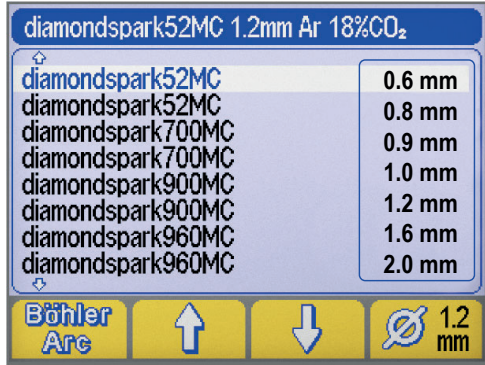

① Wire diameter

EN



Heading

Allows the display of certain pieces of important information relating to the selected process.



NO PROGRAM

Indicates that the selected synergic program is not available or is not consistent with the other system settings.

4.7 Programs screen



Allows the storage and management of 240 welding programs which can be personalised by the operator.

Programs (JOB)

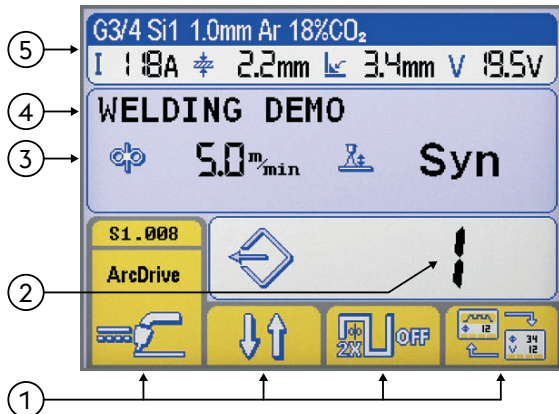

- ① Functions
- ② Number of the selected program
- ③ Main parameters of the selected program
- ④ Description of the selected program
- ⑤ Heading

See the "Main screen" section

Program storage

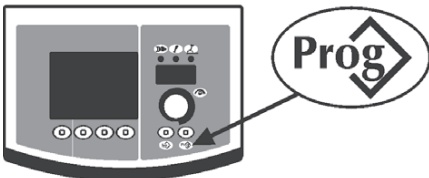

▶ Enter the "program storage" menu by pressing button for at least a second.



▶ Select the required program (or the empty memory) by rotating the encoder.

--- Memory empty



Program stored

▶ Cancel the operation by pressing button .

▶ Save all the current settings on the selected program by pressing button .





Introduce a description of the program.

- ▶ Select the required letter by rotating the encoder.
- ▶ Store the selected letter by pressing the encoder.
- ▶ Cancel the last letter by pressing button .
- ▶ Cancel the operation by pressing button .
- ▶ Confirm the operation by pressing button .





The storage of a new program on an already occupied memory location requires cancellation of the memory location by an obligatory procedure.

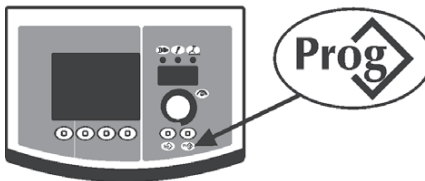

- ▶ Cancel the operation by pressing button .
- ▶ Remove the selected program by pressing button .
- ▶ Resume the storage procedure.

Program retrieval





- ▶ Retrieve the 1st program available by pressing button .
- ▶ Select the required program by rotating the encoder.
- ▶ Select the required program by pressing button .





Only the memories location occupied by a program are retrieved, while the empty ones are automatically skipped.

Program cancellation



- ▶ Select the required program by rotating the encoder.
- ▶ Remove the selected program by pressing button .
- ▶ Cancel the operation by pressing button .



- ▶ Cancel the operation by pressing button .
- ▶ Remove the selected program by pressing button .

5. SETUP

5.1 Parameter set up and setting

Permits set-up and adjustment of a series of additional parameters for improved and more accurate control of the welding system.

The parameters present at set up are organised in relation to the welding process selected and have a numerical code.

Entry to set up





- ▶ It takes place by pressing the encoder key for 5 seconds.
- ▶ The entry will be confirmed by the writing 0 on the display

Selection and adjustment of the required parameter

- ▶ Rotate the encoder until you display the numerical code for the required parameter.
- ▶ If the encoder key is pressed at this point, the value set for the parameter selected can be displayed and adjusted.

Exit from set up

- ▶ To quit the "adjustment" section, press the encoder again.
- ▶ To exit the set-up, go to parameter "0" (save and quit) and press encoder key.
- ▶ Cancel the operation by pressing button .
- ▶ To save the change and exit the set up, press the key: .

5.1.1 List of set up parameters (MMA)

0 Save and Exit



Allows you to save the changes and exit the set up.

1 Reset



Allows you to reset all the parameters to the default values.

3 Hot start



Allows adjustment of the hot start value in MMA.

Permits an adjustable hot start in the arc striking phases, facilitating the start operations.

Basic electrode

Minimum	Maximum	Default
0/off	500%	80%

Cellulosic electrode

Minimum	Maximum	Default
0/off	500%	150%

CrNi electrode

Minimum	Maximum	Default
0/off	500%	100%

Aluminum electrode

Minimum	Maximum	Default
0/off	500%	120%

Cast Iron electrode

Minimum	Maximum	Default
0/off	500%	100%

7 Welding current



Allows the regulation of the welding current.

Minimum	Maximum	Default
3 A	I _{max}	100 A

8

Arc force



Allows adjustment of the Arc force value in MMA.

Permits an adjustable energetic dynamic response in welding, facilitating the welder's operations.

Increase the value of the Arc force to reduce the risk of electrode sticking.

Basic electrode

Minimum	Maximum	Default
0/off	500%	30%

Cellulosic electrode

Minimum	Maximum	Default
0/off	500%	350%

CrNi electrode

Minimum	Maximum	Default
0/off	500%	30%

Aluminum electrode

Minimum	Maximum	Default
0/off	500%	100%

Cast Iron electrode

Minimum	Maximum	Default
0/off	500%	70%

204

Dynamic power control (DPC)



It enables the desired V/I characteristic to be selected.

I=C Constant current

The increase or reduction in arc length has no effect on the welding current required.

Recommended for electrode: Basic, Rutile, Acid, Steel, Cast iron

1±20 Falling characteristic with adjustable slope

The increase in arc length causes a reduction in welding current (and vice versa) according to the value imposed by 1 to 20 amps per volt.

Recommended for electrode: Cellulosic, Aluminum

P=C Constant power

The increase in arc length causes a reduction in the welding current (and vice versa) according to the law: $V \cdot I = K$

Recommended for electrode: Cellulosic, Aluminum

312

Arc detachment voltage



Allows you to set the voltage value at which the electric arc switch-off is forced.

Allows to manage better the various operating conditions that are created.

In the spot welding phase, for example, a low arc detachment voltage reduces re-striking of the arc when moving the electrode away from the piece, reducing spatter, burning and oxidation of the piece.

If using electrodes that require high voltages, you are advised to set a high threshold to prevent arc extinction during welding.



Never set an arc detachment voltage higher than the no-load voltage of the power source.

Basic electrode

Minimum	Maximum	Default
0/off	99.9 V	57.0 V

Cellulosic electrode

Minimum	Maximum	Default
0/off	99.9 V	70.0 V

399

Welding speed



Lets you set welding speed.

Default cm/min: reference speed for manual welding.

Syn: Sinergic value.

Minimum	Maximum	Default
1 cm/min	200 cm/min	15 cm/min

500

Machine setting



Allows the selection of the required graphic interface.

Allows access to the higher set-up levels.

Refer to section "Interface personalisation (Set up 500)"

Value	User interface
XE	Easy Mode
XA	Advanced Mode
XP	Professional Mode

Value	Selected level
USER	User
SERV	Service
vaBW	vaBW

551 Lock/unlock
 Allows the locking of the panel controls and the insertion of a protection code.
 Refer to section "Lock/unlock (Set up 551)".



552 Buzzer tone
 Permits adjustment of the buzzer tone.



Minimum	Maximum	Default
0/off	10	10

601 Regulation step
 Allows the regulation of a parameter with a step that can be personalised by the operator.



Minimum	Maximum	Default
1	Imax	1

602 External parameter CH1, CH2, CH3, CH4
 Allows the management of the external parameter 1, 2, 3, 4 (minimum value, maximum value, default value, parameter selected).
 Refer to section "External controls management (Set up 602)".



705 Circuit resistance calibration
 Allows the calibration of the system.



Refer to section "Circuit resistance calibration (set up 705)".

751 Current reading
 Allow the real value of the welding current to be displayed.



752 Voltage reading
 Allows the real value of the welding voltage to be displayed.



768 HI heat input measurement
 Allows reading of the value of the measurement of the heat input in welding.



5.1.2 List of set up parameters (TIG)

0 Save and Exit
 Allows you to save the changes and exit the set up.



1 Reset
 Allows you to reset all the parameters to the default values.



7 Welding current
 Allows the regulation of the welding current.



Minimum	Maximum	Default
3 A	Imax	100 A

399 Welding speed
 Lets you set welding speed.
 Default cm/min: reference speed for manual welding.
 Syn: Sinergic value.



Minimum	Maximum	Default
1 cm/min	200 cm/min	10 cm/min

500 Machine setting



Allows the selection of the required graphic interface.
Allows access to the higher set-up levels.
Refer to section "Interface personalisation (Set up 500)"

Value	User interface
XE	Easy Mode
XA	Advanced Mode
XP	Professional Mode

Value	Selected level
USER	User
SERV	Service
vaBW	vaBW

551 Lock/unlock



Allows the locking of the panel controls and the insertion of a protection code.
Refer to section "Lock/unlock (Set up 551)".

552 Buzzer tone



Permits adjustment of the buzzer tone.

Minimum	Maximum	Default
0/off	10	10

601 Regulation step



Allows the regulation of a parameter with a step that can be personalised by the operator.

Minimum	Maximum	Default
1	Imax	1

602 External parameter CH1, CH2, CH3, CH4



Allows the management of the external parameter 1, 2, 3, 4 (minimum value, maximum value, default value, parameter selected).
Refer to section "External controls management (Set up 602)".

705 Circuit resistance calibration



Allows the calibration of the system.
Refer to section "Circuit resistance calibration (set up 705)".

751 Current reading



Allow the real value of the welding current to be displayed.

752 Voltage reading



Allows the real value of the welding voltage to be displayed.

755 Gas flow reading (WFR)



Allows the real gas flow value to be displayed.

757 Wire speed reading



Allow the value of the motor encoder 1 to be displayed.

760 Current reading (motor 1)



Allow the real value of the current to be displayed (motor 1).

764 Coolant flow reading



Allow the value of the coolant flow reading.



765 Coolant temperature reading

Allows the real value of coolant temperature reading to be displayed.



768 HI heat input measurement

Allows reading of the value of the measurement of the heat input in welding.



801 Guard limits

Allows the setting of the warning limits and of the guard limits.

Allows the welding process to be controlled by setting warning limits and guard limits for the main measurable parameters.

Allows the accurate control of the various welding phases.

Refer to section "Guard limits (Set up 801)".

5.1.3 List of set up parameters (MIG/MAG)



0 Save and Exit

Allows you to save the changes and exit the set up.



1 Reset

Allows you to reset all the parameters to the default values.

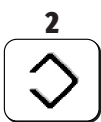

2 Synergy

Standard MIG/MAG:

Allows selection of the manual MIG (◊ Off) or synergic MIG (◊ 6) process by setting the type of material to be welded.

Pulsed MIG/MAG:

Allows selection of the synergic MIG (◊ 6) process by setting the type of material to be welded.
Allows selection of the CC/CV process.

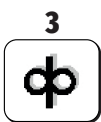

3 Wire speed

Allows the regulation of the wire feed rate.

Minimum	Maximum	Default
0.5 m/min	22.0 m/min	-



4 Current

Allows the regulation of the welding current.

Minimum	Maximum
3 A	I _{max}

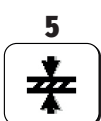

5 Workpiece thickness

Allows the thickness of the part being welded to be set.

Allows the setting of the system via the regulation of the part being welded.

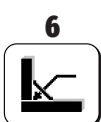

6 Corner bead "a"

Lets you set bead depth in a corner joint.

EN

7

Voltage - arc length



Allows the regulation of the arc voltage.
Allows regulation of the arc length during welding.
High voltage = long arc
Low voltage = short arc

Manual mode

Minimum	Maximum	Default
5.0 V	55.5 V	5.0 V

10

Pre-gas



Allows you to set and adjust the gas flow prior to striking of the arc.
Permits filling of the torch with gas and preparation of the environment for welding.

Minimum	Maximum	Default
0/off	99.9 s	0.1 s

11

Soft start



Permits adjustment of the wire feed speed in the phases prior to arc striking.
Permits striking at reduced speed, therefore softer and with less spatter.

Minimum	Maximum	Default
10 %	100 %	50 %

12

Motor slope



Allows you to set a gradual transition between the sparking wire speed and the welding wire speed.

Minimum	Maximum	Default
0/off	1.0 s	0/off

15

Burn back



Permits adjustment of the wire burn time, preventing sticking at the end of welding.
Permits adjustment of the length. Permits adjustment of the length of the piece of wire outside the torch.

Minimum	Maximum	Default
-2.00	+2.00	0/syn

16

Post-gas



Permits setting and adjustment of the gas flow at the end of welding.

Minimum	Maximum	Default
0/off	99.9 s	2.0 s

19

Duty cycle (double pulsed)



Permit adjustment of the duty cycle in double pulse.

Minimum	Maximum	Default
10 %	90 %	50 %

20

Double pulsed



Allows regulation of the pulsation amplitude.

Minimum	Maximum	Default
0 %	100 %	±25 %

Minimum	Maximum	Default
0.5 m/min	22 m/min	2.5 m/min

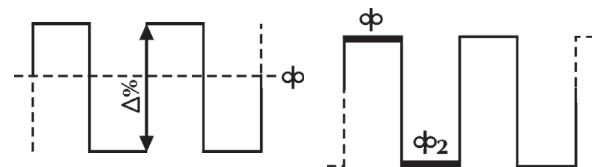

21

Pulse frequency (double pulsed)



Allows regulation of the cycle, i.e. of the impulse repetition cycle.
Allows the impulse frequency to be regulated.

Minimum	Maximum	Default
0.1 Hz	5.0 Hz	2.0 Hz

22 Secondary voltage (double pulsed)

Allows regulation of the secondary pulsation level voltage.

Makes it possible to obtain greater arc stability during the various pulsation phases.

Minimum	Maximum	Default
-5.0	+5.0	0/syn

23 Pulsed slopes (double pulsed)

Allows setting of a slope time during the pulse operation.

Minimum	Maximum	Default
1 %	100 %	50 %

24 Bilevel (4T - crater filler)

Permits adjustment of the secondary wire speed in the bilevel welding mode.

If the welder now presses and releases the button quickly, “ ϕ_2 ” can be used.

By pressing and releasing it quickly again, “ ϕ ” is used again, and so on.

Minimum	Maximum	Default
1 %	200 %	0/off

25 Initial increment

Allows regulation of the wire speed value during the first "crater-filler" welding phase.

Makes it possible to increase the energy supplied to the part during the phase when the material (still cold) requires more heat in order to melt evenly.

Minimum	Maximum	Default
20 %	200 %	120 %

26 Crater filler

Allows regulation of the wire speed value during the weld closing phase.

Makes it possible to reduce the energy supplied to the part during the phase when the material is already very hot, thus reducing the risk of unwanted deformations.

Minimum	Maximum	Default
20 %	200 %	80 %

27 Initial increment time

Lets you set the initial increment time.

Lets you automate the "crater filler" function.

Minimum	Maximum	Default
0.1 s	99.9 s	0/off

28 Crater filler time

Lets you set the "crater filler" time.

Lets you automate the "crater filler" function.

Minimum	Maximum	Default
0.1 s	99.9 s	0/off

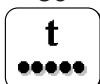
30 Spot welding

Allows you to enable the "spot welding" process and establish the welding time.

Minimum	Maximum	Default
0.1 s	99.9 s	0/off

31 Pause point

Allows you to enable the "pause point" process and establish the pause time between one welding operation and another.

Minimum	Maximum	Default
0.1 s	99.9 s	0/off



32 Secondary voltage (MIG Bilevel)

Allows regulation of the secondary pulsation level voltage.
 Makes it possible to obtain greater arc stability during the various pulsation phases.

Minimum	Maximum	Default
-5.0	+5.0	0/syn

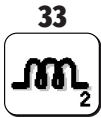

33 Secondary inductance (MIG Bilevel)

Allows regulation of the secondary pulsation level inductance.
 Makes it possible to obtain a quicker or slower arc to compensate for the welder's movements and for the natural welding instability.

Low inductance = reactive arc (more spatter).
 High inductance = less reactive arc (less spatter).

Minimum	Maximum	Default
-30	+30	0/syn



34 Initial increase slope

Allows to set a gradual transition between the initial wire speed and the welding wire speed.

Minimum	Maximum	Default
0 s	10 s	0/off



35 Crater filler slope

Allows to set a gradual transition between the welding wire speed and crater filler wire speed.

Minimum	Maximum	Default
0 s	10 s	0/off

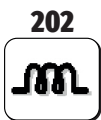

202 Inductance

Allows electronic regulation of the series inductance of the welding circuit.
 Makes it possible to obtain a quicker or slower arc to compensate for the welder's movements and for the natural welding instability.

Low inductance = reactive arc (more spatter).
 High inductance = less reactive arc (less spatter).

Minimum	Maximum	Default
-30	+30	0/syn



331 Tensione media compensata

Lets you set welding voltage.



399 Welding speed

Lets you set welding speed.
 Default cm/min: reference speed for manual welding.
 Syn: Sinergic value.

Minimum	Maximum	Default
syn min	syn max	35 cm/min



500 Machine setting

Allows the selection of the required graphic interface.
 Allows access to the higher set-up levels.
 Refer to section "Interface personalisation (Set up 500)"

Value	User interface
XE	Easy Mode
XA	Advanced Mode
XP	Professional Mode

Value	Selected level
USER	User
SERV	Service
vaBW	vaBW



551 Lock/unlock

Allows the locking of the panel controls and the insertion of a protection code.
 Refer to section "Lock/unlock (Set up 551)".

552 Buzzer tone



Permits adjustment of the buzzer tone.

Minimum	Maximum	Default
0/off	10	10

601 Regulation step



Allows the regulation of a parameter with a step that can be personalised by the operator. Functionality controlled by torch up/down button.

Minimum	Maximum	Default
1	Imax	1

602 External parameter CH1, CH2, CH3, CH4



Allows the management of the external parameter 1, 2, 3, 4 (minimum value, maximum value, default value, parameter selected). Refer to section "External controls management (Set up 602)".

606 U/D torch



Allows the management of the external parameter (U/D).

Value	Default	Callback function
0/off	-	off
1/I1	X	Current
	-	Program retrieval

705 Circuit resistance calibration



Allows the calibration of the system. Refer to section "Circuit resistance calibration (set up 705)".

751 Current reading



Allow the real value of the welding current to be displayed.

752 Voltage reading



Allows the real value of the welding voltage to be displayed.

755 Gas flow reading (WFR)



Allows the real gas flow value to be displayed.

757 Wire speed reading



Allow the value of the motor encoder 1 to be displayed.

758 Robot movement speed



Allows the arm movement speed of a robot or an automation device to be displayed.

760 Current reading (motor 1)



Allow the real value of the current to be displayed (motor 1).

761 Wire speed reading



Allow the value of the motor encoder 2 to be displayed.

EN

762 Current reading (motor 2)
 Allow the real value of the current to be displayed (motor 2).

763 Wire speed reading
 Allow the real value of the wire speed to be displayed.

764 Coolant flow reading
 Allow the value of the coolant flow reading.

765 Coolant temperature reading
 Allow the real value of coolant temperature reading to be displayed.

768 HI heat input measurement
 Allows reading of the value of the measurement of the heat input in welding.

801 Guard limits
 Allows the setting of the warning limits and of the guard limits.
 Allows the welding process to be controlled by setting warning limits and guard limits for the main measurable parameters.
 Allows the accurate control of the various welding phases.
 Refer to section "Guard limits (Set up 801)".

5.2 Specific procedures parameters

5.2.1 7 segment display personalisation

It allows you to constantly view the value of a parameter on the 7-segment display.

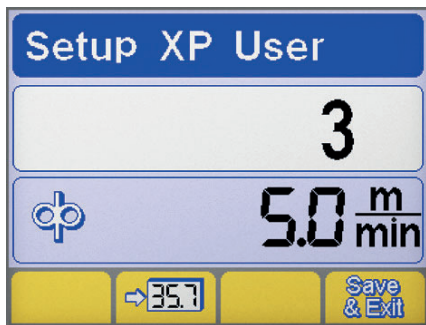

- ▶ Enter set-up by pressing the encoder button for at least 5 seconds.
- ▶ Select the required parameter by rotating the encoder.
- ▶ Store the selected parameter in the 7 segment display by pressing button
- ▶ Save and exit the current screen by pressing button

5.2.2 Interface personalisation (Set up 500)

Allows the parameters to be customized on the main menu.

500 Machine setting
 Allows the selection of the required graphic interface.











Value	User interface	
XE	Easy Mode	
XA	Advanced Mode	
XP	Professional Mode	

XE MODE







TIG

Welding parameters 

Functions       

MIG/MAG

Welding parameters  

Functions   

XA MODE

MMA

Welding parameters   







Functions     







TIG

Welding parameters 

Functions       

MIG/MAG

Welding parameters       

Functions      

XP MODE

MMA

Welding parameters   











Functions     







TIG

Welding parameters 

Functions       

MIG/MAG

Welding parameters           

Functions      

EN

5.2.3 Lock/unlock (Set up 551)

Allows the locking of the panel controls and the insertion of a protection code.

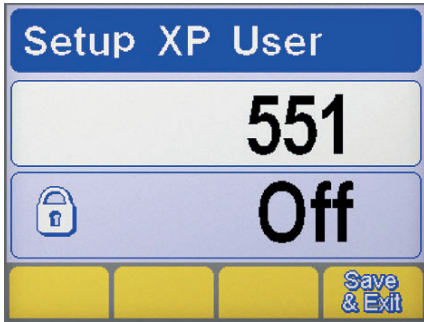

EN

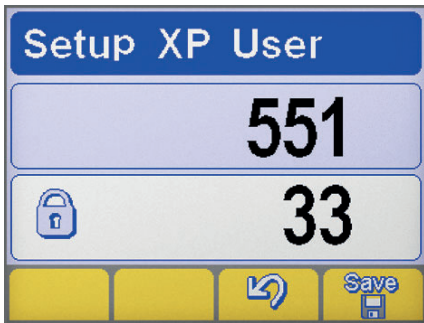

Parameter selection

- ▶ Enter set-up by pressing the encoder button for at least 5 seconds.
- ▶ Select the required parameter (551).
- ▶ Activate the regulation of the selected parameter by pressing the encoder button.





- ▶ Set a numerical code (password) by rotating the encoder.
- ▶ Confirm the operation by pressing the encoder key.
- ▶ Cancel the operation by pressing button .
- ▶ To save the change, press the button: .

Panel functions

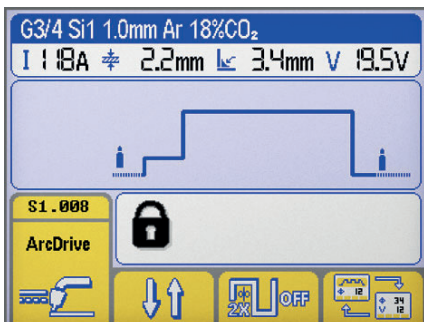

The carrying out of any operation on a locked control panel causes a special screen to appear.



- ▶ Access the panel functionalities temporarily (5 minutes) by rotating the encoder and entering the correct password.
- ▶ Confirm the operation by pressing the encoder key.
- ▶ Unlock the control panel definitively by entering set-up (follow the instructions given above) and bring back parameter 551 to "off".
- ▶ Confirm the operation by pressing the encoder key.
- ▶ To save the change, press the button: .

5.2.4 External controls management (Set up 602)

Allows the management of the external parameter 2 (minimum value, maximum value, default value, parameter selected).

Parameter selection



- ▶ Enter set-up by pressing the encoder button for at least 5 seconds.
- ▶ Select the required parameter (602).
- ▶ Enter the "External controls management" screen by pressing the encoder button.

External controls management

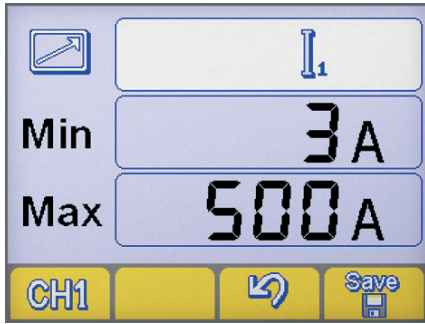

- ▶ Select the required RC remote control output (CH1, CH2, CH3, CH4) by pressing button **CH1**.
- ▶ Select the required parameter (Min-Max-parameter) by pressing the encoder button.
- ▶ Adjust the required parameter (Min-Max-parameter) by rotating the encoder.
- ▶ To save the change, press the button: **Save**.
- ▶ Cancel the operation by pressing button **↶**.

EN

5.2.5 Circuit resistance calibration (set up 705)

Allows to calibrate the generator on the current welding circuit resistance.

Parameter selection

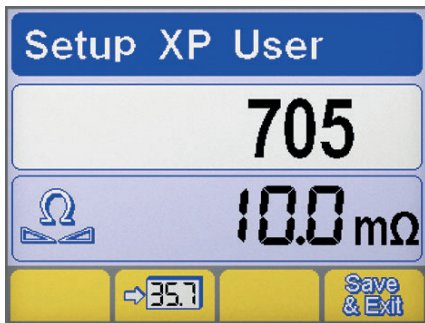

- ▶ Enter set-up by pressing the encoder button for at least 5 seconds.
- ▶ Select the required parameter (705).
- ▶ Activate the regulation of the selected parameter by pressing the encoder button.
- ▶ Connect the generator to the welding circuit (bench or piece).
- ▶ Remove the cap to put the nozzle holder tip of the exposed torch. (MIG/MAG)

Calibration

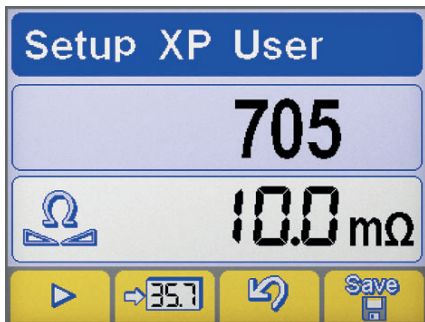

- ▶ Place the tip of the wire guide in electrical contact with the work piece. (MIG/MAG)
- ▶ Press the **▶** button to start the procedure.
- ▶ Maintain contact for at least one second.
- ▶ The value shown on the display will update after calibration.
- ▶ Confirm the operation by pressing button **Save**.
- ▶ Cancel the operation by pressing button **↶**.
- ▶ To save the change and exit the set up, press the key: **Save & Exit**.

5.2.6 Guard limits (Set up 801)

Allows the setting of the warning limits and of the guard limits.

Allows the welding process to be controlled by setting warning limits and guard limits for the main measurable parameters.

Allows the accurate control of the various welding phases.

Warning limits		⚠ MIN	⚠ MAX	Guard limits		⚠ MIN	⚠ MAX
I	Welding current			V	welding voltage		
	Gas flow reading				Robot movement speed		
	Current reading (motor 1)				Current reading (motor 2)		
	Coolant flow reading				Wire speed reading		
	Coolant temperature reading						

EN

Parameter selection

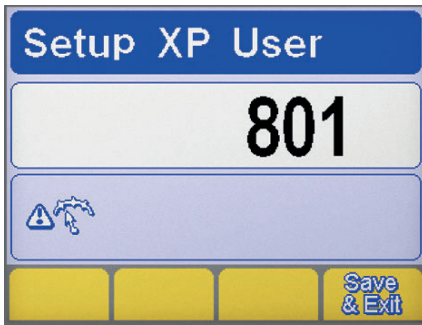

- ▶ Enter set-up by pressing the encoder button for at least 5 seconds.
- ▶ Select the required parameter (801).
- ▶ Enter the "Guard limits" screen by pressing the encoder button.

Parameter selection

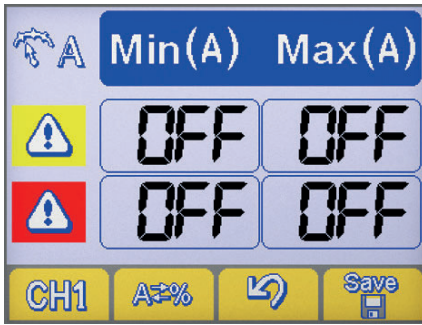

- ▶ Select the required parameter by pressing button **CH1**.
- ▶ Select the method of setting the guard limits by pressing button **A%**.

A% Mode selection

A/V Absolute value

% Percentage value

Guard limits setting

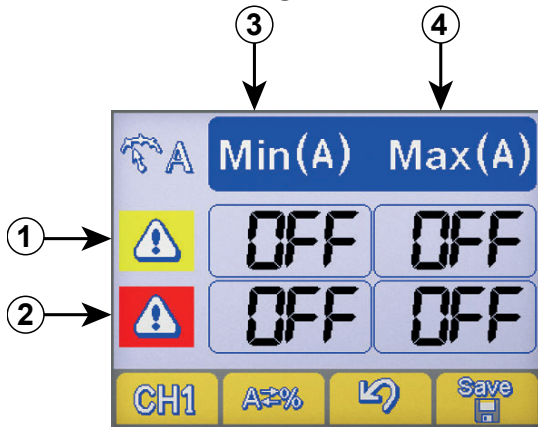

- ① Warning limits line
- ② Alarm limits line
- ③ Minimum levels column
- ④ Maximum levels column

- ▶ Select the required box by pressing the encoder key (the selected box is displayed with reverse contrast).
- ▶ Adjust the level of the selected limit by rotating the encoder.
- ▶ To save the change, press the button: **Save**.



- ▶ Passing one of the warning limits causes a visual signal to appear on the control panel.
- ▶ Passing one of the alarm limits causes a visual signal to appear on the control panel and the immediate blockage of the welding operations.
- ▶ It is possible to set start and end of welding filters to prevent error signals during the striking and extinction of the arc (consult the "Set up" section - Parameters 802-803-804).

6. MAINTENANCE



Routine maintenance must be carried out on the system according to the manufacturer's instructions. When the equipment is working, all the access and operating doors and covers must be closed and locked. The system must not be modified in any way. Prevent conductive dust from accumulating near the louvers and over them.



Any maintenance operation must be performed by qualified personnel only. The repair or replacement of any parts in the system by unauthorised personnel will invalidate the product warranty. The repair or replacement of any parts in the system must be carried out only by qualified personnel.



Disconnect the power supply before every operation!

6.1 Carry out the following periodic checks on the power source

6.1.1 System



Clean the power source inside by means of low-pressure compressed air and soft bristle brushes. Check the electric connections and all the connection cables.

6.1.2 For the maintenance or replacement of torch components, electrode holders and/or earth cables:



Check the temperature of the component and make sure that they are not overheated.



Always use gloves in compliance with the safety standards.



Use suitable wrenches and tools.

6.2 Responsibility



Failure to carry out the above maintenance will invalidate all warranties and exempt the manufacturer from any liability. The manufacturer disclaims any responsibility if the user fails to follow these instructions. For any doubts and/or problems do not hesitate to contact your nearest customer service centre.

7. ALARM CODES



ALARM

Activation of an alarm or the passing of any critical limit causes a visual signal to appear on the control panel and the immediate shut-down of welding operations.



CAUTION

























Activation of an alarm or the passing of any critical limit causes a visual signal to appear on the control panel and the immediate shut-down of welding operations.

All the alarms and all the guard limits relating to the system are listed below.

E01	Overtemperature		E02	Overtemperature	
E03	Overtemperature		E05	Overcurrent	
E06	Power module overcurrent (Boost)		E07	Wire feeder motor power supply fault	
E08	Blocked motor		E10	Power module overcurrent (Inverter)	

EN

 E11	System configuration error		 E12	Communication error (WF - DSP)	
 E13	Communication error		 E14	Invalid program	
 E15	Invalid program		 E16	Communication error (RI) (automation and robotics)	
 E17	Communication error (µP-DSP)		 E18	Invalid program	
 E19	System configuration error		 E20	Memory fault	
 E21	Data loss		 E22	Communication error (DSP)	
 E29	Incompatible measurements		 E30	Communication error (H.F.)	
 E32	Data loss		 E38	Undervoltage	
 E39	System power supply fault		 E40	System power supply fault	
 E43	Coolant shortage		 E48	Wire out (automation and robotics)	
 E49	Emergency switch (automation and robotics)		 E50	Wire stuck (automation and robotics)	
 E51	Unsupported settings (automation and robotics)		 E52	Anti-collision (automation and robotics)	
 E53	External flow switch fault (automation and robotics)		 E54	Current level exceeded (Lower limit)	
 E55	Current level exceeded (Upper limit)		 E56	Voltage level exceeded (Lower limit)	
 E57	Voltage level exceeded (Upper limit)		 E60	Speed limit exceeded (Lower limit)	
 E61	Speed limit exceeded (Upper limit)		 E62	Current level exceeded (Lower limit)	
 E63	Current level exceeded (Upper limit)		 E64	Voltage level exceeded (Lower limit)	

 E65	Voltage level exceeded (Upper limit)		 E68	Speed limit exceeded (Lower limit)	
 E69	Speed limit exceeded (Upper limit)		 E70	Guard limits set not compatible	
 E71	Coolant overtemperature		 E72	Push-pull motor overcurrent	
 E73	Wire speed limit exceeded (speed meter)		 E74	Motor 1 current level exceeded	
 E75	Motor 2 current level exceeded		 E76	Liquid coolant flow level exceeded	
 E77	Coolant temperature level exceeded		 E78	Active maintenance (automation and robotics)	

8. TROUBLESHOOTING

The system fails to come on (green LED off)

Cause

- » No mains voltage at the socket.
- » Faulty plug or cable.
- » Line fuse blown.
- » Faulty on/off switch.
- » Connection between wire feed carriage and generator incorrect or faulty.
- » Faulty electronics.

Solution

- » Check and repair the electrical system as needed.
- » Use qualified personnel only.
- » Replace the faulty component.
- » Contact the nearest service centre to have the system repaired.
- » Replace the faulty component.
- » Replace the faulty component.
- » Contact the nearest service centre to have the system repaired.
- » Check that the various parts of the system are properly connected.
- » Contact the nearest service centre to have the system repaired.

No output power (the system does not weld)

Cause

- » Faulty torch trigger button.
- » The system has overheated (temperature alarm - yellow LED on).
- » Side cover open or faulty door switch.
- » Incorrect earth connection.
- » Mains voltage out of range (yellow LED on).
- » Faulty electronics.

Solution

- » Replace the faulty component.
- » Contact the nearest service centre to have the system repaired.
- » Wait for the system to cool down without switching it off.
- » In order to ensure safe operation the side cover must be closed while welding.
- » Replace the faulty component.
- » Contact the nearest service centre to have the system repaired.
- » Earth the system correctly.
- » Read the paragraph "Installation".
- » Bring the mains voltage within the power source admissible range.
- » Connect the system correctly.
- » Read the paragraph "Connections".
- » Contact the nearest service centre to have the system repaired.

Incorrect output power

Cause

- » Incorrect selection in the welding process or faulty selector switch.

Solution

- » Select the welding process correctly.
- » Replace the faulty component.
- » Contact the nearest service centre to have the system repaired.

- | | |
|---|--|
| <ul style="list-style-type: none"> » System parameters or functions set incorrectly. | <ul style="list-style-type: none"> » Reset the system and the welding parameters. |
| <ul style="list-style-type: none"> » Faulty potentiometer/encoder for the adjustment of the welding current. | <ul style="list-style-type: none"> » Replace the faulty component. » Contact the nearest service centre to have the system repaired. |
| <ul style="list-style-type: none"> » Mains voltage out of range. | <ul style="list-style-type: none"> » Connect the system correctly. » Read the paragraph "Connections". |
| <ul style="list-style-type: none"> » Input mains phase missing. | <ul style="list-style-type: none"> » Connect the system correctly. » Read the paragraph "Connections". |
| <ul style="list-style-type: none"> » Faulty electronics. | <ul style="list-style-type: none"> » Contact the nearest service centre to have the system repaired. |

Wire feeder fails

Cause

- » Faulty torch trigger button.
- » Incorrect or worn rollers.
- » Faulty wire feeder.
- » Damaged torch liner.
- » No power supply to the wire feeder.
- » Tangled wire on the spool.
- » Melted torch nozzle (wire stuck)

Solution

- » Replace the faulty component.
- » Contact the nearest service centre to have the system repaired.
- » Replace the rollers.
- » Replace the faulty component.
- » Contact the nearest service centre to have the system repaired.
- » Replace the faulty component.
- » Contact the nearest service centre to have the system repaired.
- » Check the connection to the power source.
- » Read the paragraph "Connections".
- » Contact the nearest service centre to have the system repaired.
- » Untangle the wire or replace the wire spool.
- » Replace the faulty component.

Irregular wire feeding

Cause

- » Faulty torch trigger button.
- » Incorrect or worn rollers.
- » Faulty wire feeder.
- » Damaged torch liner.
- » Incorrect spindle clutch or misadjusted rolls locking devices.

Solution

- » Replace the faulty component.
- » Contact the nearest service centre to have the system repaired.
- » Replace the rollers.
- » Replace the faulty component.
- » Contact the nearest service centre to have the system repaired.
- » Replace the faulty component.
- » Contact the nearest service centre to have the system repaired.
- » Release the clutch.
- » Increase the rolls locking pressure.

Arc instability

Cause

- » Insufficient shielding gas.
- » Humidity in the welding gas.
- » Incorrect welding parameters.

Solution

- » Adjust the air flow.
- » Check that the diffuser and the gas nozzle of the torch are in good condition.
- » Always use quality materials and products.
- » Ensure the gas supply system is always in perfect condition.
- » Check the welding system carefully.
- » Contact the nearest service centre to have the system repaired.

Excessive spatter

Cause

- » Incorrect arc length.
- » Incorrect welding parameters.
- » Insufficient shielding gas.
- » Incorrect arc regulation.

Solution

- » Decrease the distance between the electrode and the piece.
- » Decrease the welding voltage.
- » Decrease the welding current.
- » Adjust the air flow.
- » Check that the diffuser and the gas nozzle of the torch are in good condition.
- » Increase the equivalent circuit inductive value setting.
- » Use a higher setting inductive connection.

» Incorrect welding mode.

» Decrease the torch angle.

Insufficient penetration

Cause

- » Incorrect welding mode.
- » Incorrect welding parameters.
- » Incorrect electrode.
- » Incorrect edge preparation.
- » Incorrect earth connection.
- » Pieces to be welded too big.

Solution

- » Decrease the travel speed while welding.
- » Increase the welding current.
- » Use a smaller diameter electrode.
- » Increase the chamfering.
- » Earth the system correctly.
- » Read the paragraph "Installation".
- » Increase the welding current.

Slag inclusions

Cause

- » Poor cleanliness.
- » Electrode diameter too big.
- » Incorrect edge preparation.
- » Incorrect welding mode.

Solution

- » Clean the pieces accurately before welding.
- » Use a smaller diameter electrode.
- » Increase the chamfering.
- » Decrease the distance between the electrode and the piece.
- » Move regularly during all the welding operations.

Tungsten inclusions

Cause

- » Incorrect welding parameters.
- » Incorrect electrode.
- » Incorrect welding mode.

Solution

- » Decrease the welding current.
- » Use a bigger diameter electrode.
- » Always use quality materials and products.
- » Sharpen the electrode carefully.
- » Avoid contact between the electrode and the weld pool.

Blowholes

Cause

- » Insufficient shielding gas.

Solution

- » Adjust the air flow.
- » Check that the diffuser and the gas nozzle of the torch are in good condition.

Sticking

Cause

- » Incorrect arc length.
- » Incorrect welding parameters.
- » Incorrect welding mode.
- » Pieces to be welded too big.
- » Incorrect arc regulation.

Solution

- » Increase the distance between the electrode and the piece.
- » Increase the welding voltage.
- » Increase the welding current.
- » Increase the welding voltage.
- » Angle the torch more.
- » Increase the welding current.
- » Increase the equivalent circuit inductive value setting.
- » Use a higher setting inductive connection.

Undercuts

Cause

- » Incorrect welding parameters.
- » Incorrect arc length.
- » Incorrect welding mode.
- » Insufficient shielding gas.

Solution

- » Decrease the welding current.
- » Use a smaller diameter electrode.
- » Decrease the distance between the electrode and the piece.
- » Decrease the welding voltage.
- » Decrease the side oscillation speed while filling.
- » Decrease the travel speed while welding.
- » Use gases suitable for the materials to be welded.

Oxidations

Cause

- » Insufficient shielding gas.

Solution

- » Adjust the air flow.
- » Check that the diffuser and the gas nozzle of the torch are in good condition.

Porosity

Cause

- » Grease, varnish, rust or dirt on the workpieces to be welded.
- » Grease, varnish, rust or dirt on the filler material.
- » Humidity in the filler metal.
- » Incorrect arc length.
- » Humidity in the welding gas.
- » Insufficient shielding gas.
- » The weld pool solidifies too quickly.

Solution

- » Clean the pieces accurately before welding.
- » Always use quality materials and products.
- » Keep the filler metal always in perfect condition.
- » Always use quality materials and products.
- » Keep the filler metal always in perfect condition.
- » Decrease the distance between the electrode and the piece.
- » Decrease the welding voltage.
- » Always use quality materials and products.
- » Ensure the gas supply system is always in perfect condition.
- » Adjust the air flow.
- » Check that the diffuser and the gas nozzle of the torch are in good condition.
- » Decrease the travel speed while welding.
- » Pre-heat the workpieces to be welded.
- » Increase the welding current.

Hot cracks

Cause

- » Incorrect welding parameters.
- » Grease, varnish, rust or dirt on the workpieces to be welded.
- » Grease, varnish, rust or dirt on the filler material.
- » Incorrect welding mode.
- » Pieces to be welded have different characteristics.

Solution

- » Decrease the welding current.
- » Use a smaller diameter electrode.
- » Clean the pieces accurately before welding.
- » Always use quality materials and products.
- » Keep the filler metal always in perfect condition.
- » Carry out the correct sequence of operations for the type of joint to be welded.
- » Carry out buttering before welding.

Cold cracks

Cause

- » Humidity in the filler metal.
- » Particular geometry of the joint to be welded.

Solution

- » Always use quality materials and products.
- » Keep the filler metal always in perfect condition.
- » Pre-heat the workpieces to be welded.
- » Carry out post-heating.
- » Carry out the correct sequence of operations for the type of joint to be welded.

9. WELDING THEORY

9.1 Manual Metal Arc welding (MMA)

Preparing the edges

To obtain good welding joints it is advisable to work on clean parts, free from oxidations, rust or other contaminating agents.

Choosing the electrode

The diameter of the electrode to be used depends on the thickness of the material, the position, the type of joint and the type of preparation of the piece to be welded. Electrodes of large diameter obviously require very high currents with consequent high heat supply during the welding.

Type of coating	Property	Use
Rutile	Easy to use	All positions
Acid	High melting speed	Flat
Basic	High quality of joint	All positions

Choosing the welding current

The range of welding current related to the type of electrode used is specified by the manufacturer usually on the electrode packaging.

Striking and maintaining the arc

The electric arc is produced by scratching the electrode tip on the workpiece connected to the earth cable and, once the arc has been struck, by rapidly withdrawing the electrode to the normal welding distance.

Generally, to improve the arc striking behaviour a higher initial current is given in order to heat suddenly the tip of the electrode and so aid the arc establishing (Hot Start). Once the arc has been struck, the central part of the electrode starts melting forming tiny globules which are transferred into the molten weld pool on the workpiece surface through the arc stream. The external coating of the electrode is being consumed and this supplies the shielding gas for the weld pool, ensuring the good quality of the weld. To prevent the molten material globules cause the extinguishing of the arc by short-circuiting and sticking the electrode to the weld pool, due to their proximity, a temporary increase of the welding current is given in order to melt the forming short-circuit (Arc Force). If the electrode sticks to the workpiece, the short circuit current should be reduced to the minimum (antisticking).

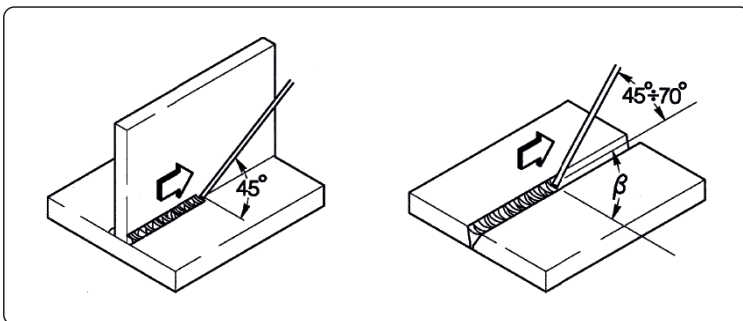

Carrying out the welding

The welding position varies depending on the number of runs; the electrode movement is normally carried out with oscillations and stops at the sides of the bead, in such a way as to avoid an excessive accumulation of filler metal at the centre.

Removing the slag

Welding using covered electrodes requires the removal of the slag after each run. The slag is removed by a small hammer or is brushed away if friable.

9.2 TIG welding (continuous arc)

Description

The TIG (Tungsten Inert Gas) welding process is based on the presence of an electric arc struck between a non-consumable electrode (pure or alloyed tungsten with an approximate melting temperature of 3370°C) and the work-piece; an inert gas (argon) atmosphere protects the weld pool. To avoid dangerous inclusions of tungsten in the joint, the electrode must never come in contact with the workpiece; for this reason the welding power source is usually equipped with an arc striking device that generates a high frequency, high voltage discharge between the tip of the electrode and the workpiece. Thus, thanks to the electric spark, ionizing the gas atmosphere, the welding arc is struck without any contact between electrode and workpiece. Another type of start is also possible, with reduced tungsten inclusions: the lift start, which does not require high frequency, but only an initial short-circuit at low current between the electrode and the workpiece; when the electrode is lifted, the arc is established and the current increases until reaching the set welding value. To improve the quality of the filling at the end of the welding bead it is important to control carefully the down slope of the current and it is necessary that the gas still flows in the welding pool for some seconds after the arc is extinguished. Under many operating conditions, it is useful to be able to use two preset welding currents and to be able to switch easily from one to the other (BILEVEL).

Welding polarity

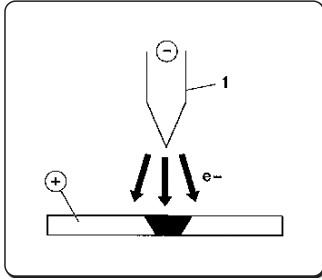

D.C.S.P. (Direct Current Straight Polarity)

This is the most used polarity and ensures limited wear of the electrode (1), since 70% of the heat is concentrated in the anode (piece).
Narrow and deep weld pools are obtained, with high travel speeds and low heat supply.

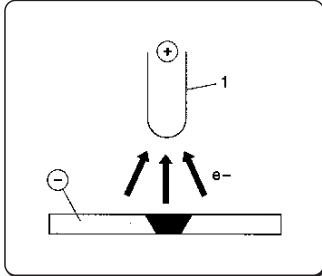

D.C.R.P. (Direct Current Reverse Polarity)

The reverse polarity is used for welding alloys covered with a layer of refractory oxide with higher melting temperature compared with metals.
High currents cannot be used, since they would cause excessive wear on the electrode.

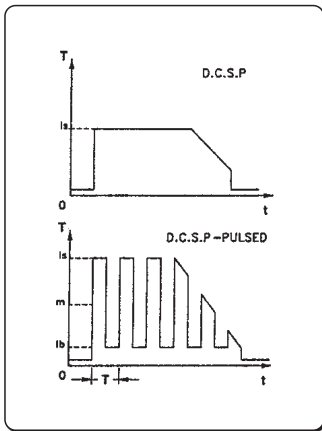

D.C.S.P.-Pulsed (Direct Current Straight Polarity Pulsed)

The use of pulsed direct current allows better control, in particular operating conditions, of the welding pool width and depth.
The welding pool is formed by the peak pulses (I_p), while the basic current (I_b) keeps the arc ignited. This operating mode helps to weld thinner metal sheets with less deformations, a better form factor and consequently a lower danger of hot cracks and gas penetration.
Increasing the frequency (MF) the arc becomes narrower, more concentrated, more stable and the quality of welding on thin sheets is further increased.

Steel TIG welding

The TIG procedure is very effective for welding both carbon and alloyed steel, for first runs on pipes and for welding where good appearance is important. Straight polarity is required (D.C.S.P.).

Preparing the edges

Careful cleaning and preparation of the edges are required.

Choosing and preparing the electrode

You are advised to use thorium tungsten electrodes (2% thorium-red coloured) or alternatively cerium or lanthanum electrodes with the following diameters:

Ø electrode	Current range
1.0 mm	15÷75 A
1.6 mm	60÷150 A
2.4 mm	130÷240 A

The electrode must be sharpened as shown in the figure.

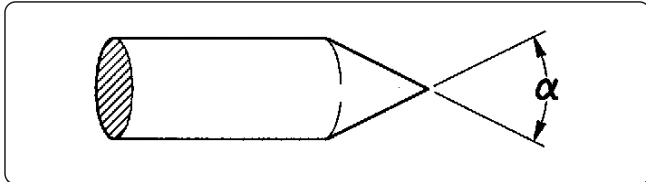

α°	Current range
30	0÷30 A
60÷90	30÷120 A
90÷120	120÷250 A

Filler metal

The filler rods must have mechanical characteristics comparable to those of the parent metal.
Do not use strips obtained from the parent metal, since they may contain working impurities that can negatively affect the quality of the welds.

Shielding gas

Typically, pure argon (99.99%) is used.

EN

Welding current	Ø electrode	Gas nozzle n°	Gas nozzle	Argon flux
30 A	0÷30 mm	4/5	6/8.0 mm	5-6 l/min
60÷90 A	30÷120 mm	4/5/6	6.5/8.0/9.5 mm	6-7 l/min
90÷120 A	120÷250 mm	6/7	9.5/11.0 mm	7-8 l/min

Copper TIG welding

Since TIG welding is a process characterized by high heat concentration, it is particularly suitable for welding materials with high thermal conductivity, like copper.

For TIG welding of copper, follow the same directions as for TIG welding of steel or special instructions.

9.3 Continuous wire welding (MIG/MAG)

Introduction

A MIG system consists of a direct current power source, wire feeder, wire spool, torch and gas.

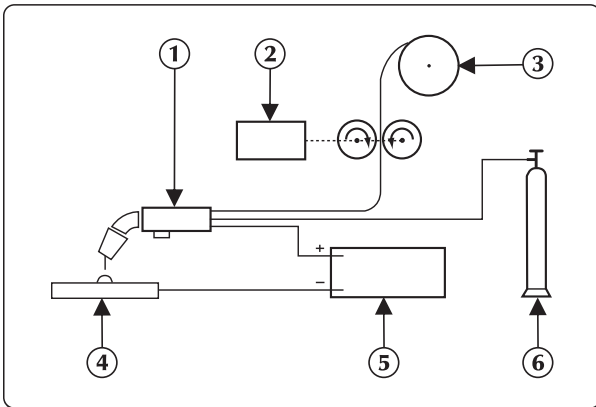

MIG manual welding system

The current is transferred to the arc through the fusible electrode (wire connected to positive pole);

In this procedure the melted metal is transferred onto the workpiece through the arc stream.

The current is transferred to the arc through the fusible electrode (wire connected to positive pole); in this procedure the melted metal is transferred onto the workpiece through the arc stream. The automatic feeding of the continuous filler material electrode (wire) is necessary to refill the wire that has melted during welding.

Methods

In MIG welding, two main metal transfer mechanisms are present and they can be classified according to the means by which metal is transferred from the electrode to the workpiece.

The first one, defined "SHORT-ARC", produces a small, fast-solidifying weld pool where metal is transferred from the electrode to the workpiece only for a short period when the electrode is in contact with the weld pool. In this timeframe, the electrode comes into direct contact with the weld pool generating a short circuit that melts the wire which is therefore interrupted. The arc then turns on again and the cycle is repeated.

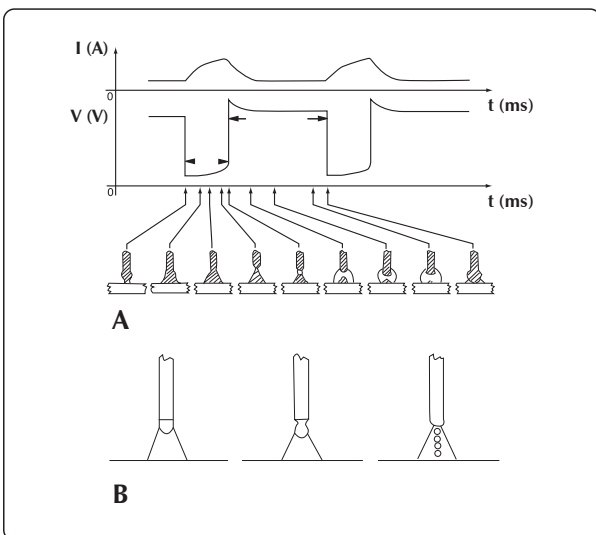

SHORT cycle and SPRAY ARC welding

Another mechanism for metal transfer is called the "SPRAY-ARC" method, where the metal transfer occurs in the form of very small drops that are formed and detached from the tip of the wire and transferred to the weld pool through the arc stream (Fig. 2b).

Welding parameters

The visibility of the arc reduces the need for the user to strictly observe the adjustment tables as he can directly monitor the weld pool.

- The voltage directly affects the appearance of the bead, but the dimensions of the weld bead can be varied according to requirements by manually moving the torch to obtain variable deposits with constant voltage.
- The wire feeding speed is proportional to the welding current.

The two figures show the relationships between the various welding parameters.

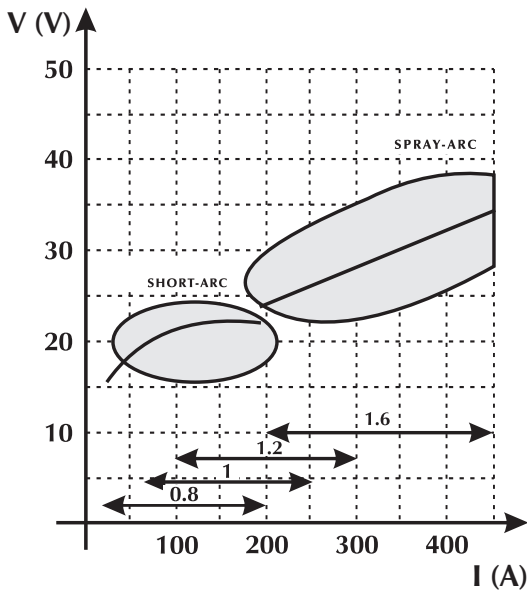
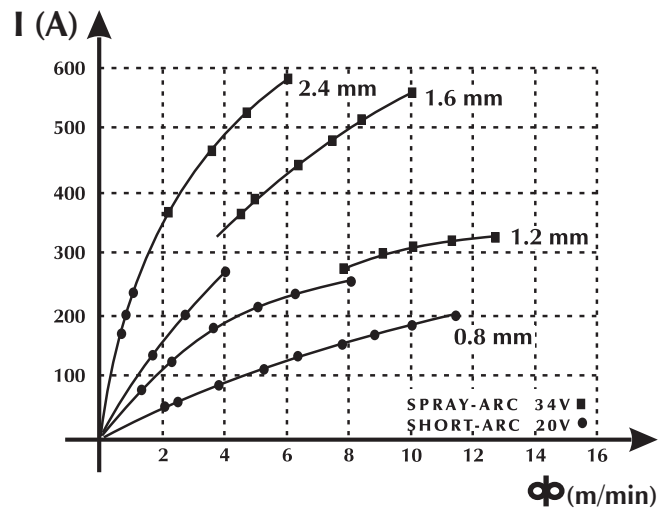
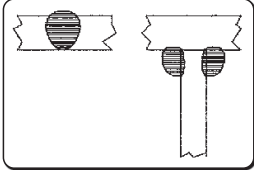
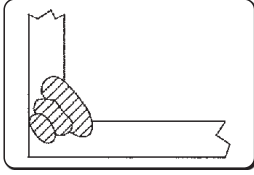
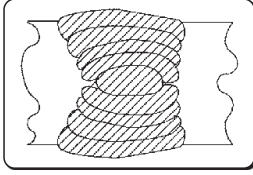

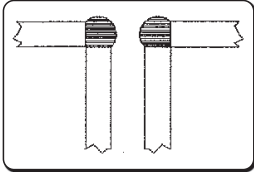
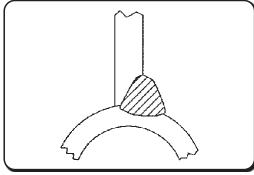
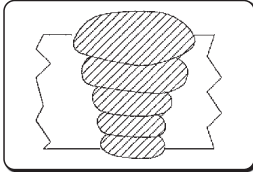
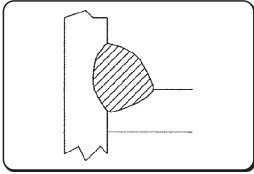
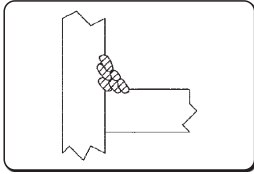
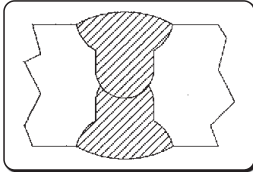

Diagram for selection the of best working characteristic.



Relationship between wire feeding speed and current amperage (melting characteristic) according to wire diameter.

Selection guide of welding parameters with reference to the most typical applications and most commonly used wires.

Voltage arc	Ø 0,8 mm	Ø 1,0-1,2 mm	Ø 1,6 mm	Ø 2,4 mm
16V - 22V SHORT - ARC				
	60 - 160 A Low penetration for thin materials	100 - 175 A Good penetration and melting control	120 - 180 A Good flat and vertical melting	150 - 200 A Not used
	<hr/>			
	24V - 28V GLOBULAR-ARC (Transition area)			
150 - 250 A Automatic fillet welding		200 - 300 A Automatic welding with high voltage	250 - 350 A Automatic welding downwards	300 - 400 A Not used
<hr/>				
30V - 45V SPRAY - ARC				
	150 - 250 A Low penetration with adjustment to 200 A	200 - 350 A Automatic welding with multiple runs	300 - 500 A Good penetration downwards	500 - 750 A Good penetration, high deposit on thick materials

Gases

MIG-MAG welding is defined mainly by the type of gas used: inert for MIG welding (Metal Inert Gas), active for MAG welding (Metal Active Gas).

- Carbon dioxide (CO₂)

Using CO₂ as a shielding gas, high penetrations and low operating cost are obtained with high feeding speed and good mechanical properties. On the other hand, the use of this gas creates considerable problems with the final chemical composition of the joints as there is a loss of easily oxidisable elements with simultaneous enrichment of carbon in the weld pool. Welding with pure CO₂ also creates other types of problems such as excessive spatter and the formation of carbon monoxide porosity.

- Argon

This inert gas is used pure in the welding of light alloys whereas, in chrome-nickel stainless steel welding, it is preferable using argon with the addition of oxygen and CO₂ in a percentage of 2% as this contributes to the stability of the arc and improves the form of the bead.

- Helium

This gas is used as an alternative to argon and permits greater penetration (on thick material) and faster wire feeding.

- Argon-Helium mixture

Provides a more stable arc than pure helium, and greater penetration and travel speed than argon.

- Argon-CO₂ and Argon-CO₂-Oxygen mixture

These mixtures are used in the welding of ferrous materials especially in SHORT-ARC operating mode as they improve the specific heat contribution. They can also be used in SPRAY-ARC.

Normally the mixture contains a percentage of CO₂ ranging from 8% to 20% and O₂ around 5%.

Consult the instruction manual of the system.

10. TECHNICAL SPECIFICATIONS

EN

Electrical characteristics			U.M.
Power supply voltage U1 (50/60 Hz)	3x230 (±15%)	3x400 (±15%)	Vac
Zmax (@PCC) *	62	62	mΩ
Slow blow line fuse	30	20	A
Communication bus	DIGITAL	DIGITAL	
Maximum input power	13.3	13.0	kVA
Maximum input power	12.8	12.4	kW
Power consumption in standby	71	71	W
Power factor (PF)	0.96	0.95	
Efficiency (μ)	85	85	%
Cos φ	0.99	0.99	
Max. input current I1max	32.9	18.8	A
Effective current I1eff	20.8	13.3	A
Adjustment range (MMA)	3-320	3-320	A
Open circuit voltage	75	75	Vdc

* This equipment complies with EN / IEC 61000-3-11.

* This equipment complies with EN / IEC 61000-3-12 if the maximum permissible mains impedance at the interface point to the public grid (point of common coupling, PCC) is smaller than or equal to the Zmax stated value. If it is connected to a public low voltage system, it is the responsibility of the installer or user of the equipment to ensure, by consultation with the distribution network operator if necessary, that the equipment may be connected.

Duty factor	3x230V	3x400V	U.M.
Duty factor MMA (40°C)			
(X=35%)	320	-	A
(X=50%)	-	320	A
(X=60%)	270	300	A
(X=100%)	230	250	A
Duty factor MMA (25°C)			
(X=60%)	320	320	A
(X=100%)	270	270	A
Duty factor TIG (40°C)			
(X=45%)	320	-	A
(X=60%)	300	320	A
(X=100%)	250	270	A
Duty factor TIG (25°C)			
(X=70%)	320	320	A
(X=100%)	270	270	A
Duty factor MIG/MAG (40°C)			
(X=35%)	320	-	A
(X=50%)	-	320	A
(X=60%)	280	310	A
(X=100%)	230	250	A
Duty factor MIG/MAG (25°C)			
(X=60%)	320	-	A
(X=70%)	-	320	A
(X=100%)	270	270	A

Physical characteristics			U.M.
IP Protection rating	IP23S		
Insulation class	H		
Dimensions (lxdxh)	620x240x460		mm
Weight	26.7		Kg
Manufacturing Standards	EN IEC 60974-1/A1:2019 EN IEC 60974-3:2019 EN 60974-10/A1:2015		
Power supply cable section	4x4		mm ²
Length of power supply cable	5		m

11. RATING PLATE

VOESTALPINE BÖHLER WELDING SELCO S.R.L. Via Palladio, 19 - ONARA (PADOVA) - ITALY				
URANOS NX 3200 PME			N°	
EN IEC 60974-1/A1:2019 60974-10/A1:2015 Class A				
	---	3A/20.0V - 320A (320A)/32.8V (32.8V)		
		X (40°C)	50% (35%)	60%
	U ₀	I ₂	320A (320A)	300A (270A) 250A (230A)
	75V	U ₂	32.8V (32.8V) 32.0V (30.8V)	30.0V (29.2V)
	---	3A/10.0V - 320A (320A)/22.8V (22.8V)		
		X (40°C)	(45%)	60%
	U ₀	I ₂	(320A)	320A (300A) 270A (250A)
	75V	U ₂	(22.8V) 22.8V (22.0V)	20.8V (20.0V)
	---	3A/14.0V - 320A (320A)/30.0V (30.0V)		
		X (40°C)	50% (35%)	60%
	U ₀	I ₂	320A (320A)	310A (280A) 250A (230A)
	75V	U ₂	30.0V (30.0V) 29.5V (28.5V)	26.5V (25.5V)
U ₁ 400V(230V)		I _{1max} 18.8A(32.9A)		I _{1eff} 13.3A(20.8A)
IP 23 S				

12. MEANING RATING PLATE

1		2			
3		4			
5		6			
7	9	23			
		11			
8	10	12	15	16	17
		13	15A	16A	17A
		14	15B	16B	17B
		12	15	16	17
8	10	13	15A	16A	17A
		14	15B	16B	17B
		12	15	16	17
		13	15A	16A	17A
14	15B	16B	17B		
18	19	20	21		
22					

CE EU declaration of conformity
 EAC EAC declaration of conformity
 UKCA UKCA declaration of conformity

- 1 Trademark
- 2 Name and address of manufacturer
- 3 Machine model
- 4 Serial no.
 XXXXXXXXXXXX Year of manufacture
- 5 Welding unit symbol
- 6 Reference to construction standards
- 7 Welding process symbol
- 8 Symbol for equipments suitable for operation in environments with increased electrical shock risk
- 9 Welding current symbol
- 10 Rated no load voltage
- 11 Max-Min current range and corresponding conventional load voltage
- 12 Intermittent cycle symbol
- 13 Rated welding current symbol
- 14 Rated welding voltage symbol
- 15 Intermittent cycle values
- 16 Intermittent cycle values
- 17 Intermittent cycle values
- 15A Rated welding current values
- 16A Rated welding current values
- 17A Rated welding current values
- 15B Conventional load voltage values
- 16B Conventional load voltage values
- 17B Conventional load voltage values
- 18 Power supply symbol
- 19 Rated power supply voltage
- 20 Maximum rated power supply current
- 21 Maximum effective power supply current
- 22 Protection rating
- 23 Rated peak voltage

EN

EU-KONFORMITÄTSERKLÄRUNG

Der Bauarbeiter

voestalpine Böhler Welding Selco S.r.l. - Via Palladio, 19 - 35019 Onara di Tombolo (PD) - ITALY
Tel. +39 049 9413/111 - Fax +39 049 9413/311 - www.voestalpine.com/welding

erklärt unter seiner alleinigen Verantwortung, dass das folgende Produkt:

URANOS NX 3200 PME	55.03.066
	55.03.070

den folgenden EU Richtlinien entspricht:

2014/35/EU LOW VOLTAGE DIRECTIVE
2014/30/EU EMC DIRECTIVE
2011/65/EU RoHS DIRECTIVE

dass die folgenden harmonisierten Normen angewendet wurden:

EN IEC 60974-1/A1:2019	WELDING POWER SOURCE
EN 60974-10/A1:2015	ELECTROMAGNETIC COMPATIBILITY REQUIREMENTS

Die Dokumentation, die die Einhaltung der Richtlinien bescheinigt, wird beim oben genannten Hersteller für Inspektionen aufbewahrt.

Jede von der Firma voestalpine Böhler Welding Selco S.r.l. nicht genehmigte Änderung hebt die Gültigkeit dieser Erklärung auf.

Onara di Tombolo, 15/10/2021

voestalpine Böhler Welding Selco s.r.l.

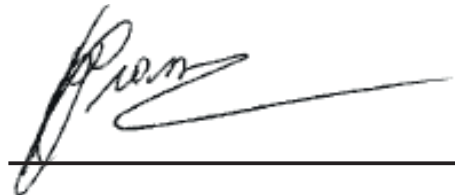

Lino Frasson

INDEX

1. WARNUNG	97
1.1 Arbeitsumgebung	97
1.2 Persönlicher Schutz und Schutz Dritter.....	97
1.3 Rauch- und Gasschutz.....	98
1.4 Brand-/Explosionsverhütung.....	98
1.5 Schutzmaßnahmen im Umgang mit Gasflaschen.....	99
1.6 Schutz vor Elektrischem Schlag.....	99
1.7 Elektromagnetische Felder und Störungen	99
1.8 Schutzart IP	100
1.9 Entsorgung	100
2. INSTALLATION	101
2.1 Heben, Transportieren und Abladen.....	101
2.2 Aufstellen der Anlage.....	101
2.3 Elektrischer Anschluss.....	101
2.4 Inbetriebnahme	102
3. PRÄSENTATION DER ANLAGE.....	104
3.1 Hintere Tafel.....	104
3.2 Buchsenfeld.....	104
3.3 Frontbedienfeld.....	104
3.4 Frontbedienfeld.....	105
4. VERWENDUNG VON GERÄTEN	106
4.1 Startbildschirm	106
4.2 Test-Anzeige.....	106
4.3 Haupt-Menü	107
4.4 Hauptbildschirmseite des E-Handsweißprozesses.....	107
5. SETUP.....	114
5.1 Setup und Parametereinstellung.....	114
5.2 Spezielle Verfahren zur Verwendung der Parameter	123
6. WARTUNG	128
6.1 Führen Sie folgende regelmäßige Überprüfungen am Generator durch	128
6.2 Verantwortung.....	128
7. ALARMCODES	128
8. FEHLERSUCHE.....	130
9. THEORETISCHE HINWEISE ZUM SCHWEISSEN	134
9.1 Schweißen mit Mantelelektroden (E-Hand-Schweißen)	134
9.2 WIG-Schweißen (kontinuierlicher Lichtbogen).....	135
9.3 Schweißen mit Endlosdrahtelektroden (MIG/MAG).....	136
10. TECHNISCHE DATEN	139
11. LEISTUNGSSCHILDER	140
12. BEDEUTUNG DER ANGABEN AUF DEM LEISTUNGSSCHILD	140
13. SCHALTPLAN	557
14. VERBINDER	559
15. ERSATZTEILVERZEICHNIS.....	560

SYMBOLE



Drohende Gefahren, die schwere Verletzungen verursachen und gefährliche Verhaltensweisen, die zu schweren Verletzungen führen können.



Verhaltensweisen, die leichte Verletzungen oder Sachschäden verursachen könnten.



Die mit diesem Symbol gekennzeichneten Anmerkungen sind technischer Art und erleichtern die Arbeitsschritte.

1. WARNUNG



Vor Arbeitsbeginn lesen Sie das Anleitungsheft sorgfältig durch und vergewissern Sie sich, ob Sie alles richtig verstanden haben.

Nehmen Sie keine Änderungen vor und führen Sie keine hier nicht beschriebenen Instandhaltungsarbeiten durch. Der Hersteller haftet nicht für Personen- oder Sachschäden, die durch unsachgemäßen Gebrauch oder Nichteinhaltung der Vorgaben dieser Anleitung seitens des Benutzers verursacht werden.

Manter sempre as instruções de utilização no local de utilização do aparelho. Para além das instruções de utilização, observar as normas gerais e os regulamentos locais de prevenção de acidentes e proteção ambiental em vigor.



Todas as pessoas envolvidas na colocação em serviço, utilização, manutenção e reparação do aparelho devem:

- ser titulares de qualificação apropriada
- dispor das competências de soldadura necessárias
- ler integralmente e respeitar rigorosamente estas instruções de utilização

Bei Fragen oder Unklarheiten im Umgang mit dem Gerät wenden Sie sich an Fachpersonal.

1.1 Arbeitsumgebung



Die gesamte Anlage darf ausschließlich für den Zweck verwendet werden, für den sie konzipiert wurde, auf die Art und in dem Umfang, der auf dem Leistungsschild und/oder im vorliegenden Handbuch festgelegt ist und gemäß den nationalen und internationalen Sicherheitsvorschriften. Ein anderer Verwendungszweck, als der ausdrücklich vom Hersteller angegebene, ist unsachgemäß und gefährlich. Der Hersteller übernimmt in solchen Fällen keinerlei Haftung.



Dieses Gerät darf nur für gewerbliche Zwecke im industriellen Umfeld angewendet werden. Der Hersteller haftet nicht für Schäden, die durch den Gebrauch der Anlage im Haushalt verursacht wurden.



Die Anlage darf nur bei Umgebungstemperaturen zwischen -10°C und +40°C (zwischen +14°F und +104°F) benutzt werden.

Die Anlage darf nur bei Umgebungstemperaturen zwischen -25°C und +55°C (zwischen -13°F und 131°F) befördert und gelagert werden.

Die Anlage darf nur in einer Umgebung benutzt werden, die frei von Staub, Säure, Gas und ätzenden Substanzen ist.

Die Anlage darf nicht in einer Umgebung mit einer relativen Luftfeuchte über 50% bei 40°C (104°F) benutzt werden.

Die Anlage darf nicht in einer Umgebung mit einer relativen Luftfeuchte über 90% bei 20°C (68°F) benutzt werden.

Die Anlage darf nicht in einer Höhe von mehr als 2000m über NN (6500 Fuß) benutzt werden.



Verwenden Sie das Gerät nicht, um Rohre aufzutauen.

Verwenden Sie das Gerät nicht, um Batterien und/oder Akkus aufzuladen.

Verwenden Sie das Gerät nicht, um Starthilfe an Motoren zu geben.

1.2 Persönlicher Schutz und Schutz Dritter



Der Schweißvorgang verursacht schädliche Strahlungs-, Lärm-, Hitze- und Gasemissionen. Erstellen Sie eine feuerfeste Trennwand, um den Schweißbereich vor Strahlen, Funken und leichter Schlacke zu schützen. Anwesende dritte Personen darauf hinweisen, nicht in den Schweißlichtbogen oder das glühende Metall zu schauen und sich ausreichend zu schützen.



Schutzkleidung anziehen, um die Haut vor Lichtbogenstrahlung, Funken und glühend heißem Metall zu schützen. Die getragene Kleidung muss den ganzen Körper bedecken und wie folgt beschaffen sein:

- unversehrt und in gutem Zustand
- feuerfest
- isolierend und trocken
- am Körper anliegend und ohne Aufschläge



Immer normgerechtes, widerstandsfähiges und wasserfestes Schuhwerk tragen.

Immer normgerechte Handschuhe tragen, die die elektrische und thermische Isolierung gewährleisten.



Masken mit seitlichem Gesichtsschutz und geeignetem Schutzfilter (mindestens Schutzstufe 10 oder höher) für die Augen tragen.



Immer Schutzbrillen mit Seitenschutz aufsetzen, insbesondere beim manuellen oder mechanischen Entfernen der Schweißschlacke.



Keine Kontaktlinsen tragen!

DE



Gehörschutz tragen, wenn ein gefährlicher Lärmpegel beim Schweißen erreicht wird. Wenn der Geräuschpegel die gesetzlich festgelegten Grenzwerte überschreitet, den Arbeitsbereich abgrenzen und prüfen, ob die Personen, die diesen Bereich betreten, Gehörschutz tragen.



Die Seitenpaneele beim Schweißen immer geschlossen halten. Die Anlage darf keiner Änderung unterzogen werden.



Die Seitenpaneele beim Schweißen immer geschlossen halten. Den Kontakt von Händen, Haaren, Kleidung, Werkzeugen usw. mit sich bewegenden Teilen vermeiden, wie: ventilatoren, zahnradern, rollen und wellen, drahtspulen. Die Zahnräder bei laufendem Drahtvorschubgerät nicht berühren. Die Anlage darf keiner Änderung unterzogen werden. Umgehen/Überbrücken der Schutzvorrichtungen an Drahtvorschubgeräten ist besonders gefährlich und befreit den Hersteller von jeglicher Haftung für Personen- und Sachschäden.



Den Kopf während des Ladens und Vorschubs des Drahts fern vom MIG/MAG-Brenner halten. Der austretende Draht kann ernsthafte Verletzungen an Händen, Gesicht und Augen verursachen.



Soeben geschweißte Werkstücke nicht berühren: die Hitze kann schwere Verbrennungen verursachen. Alle oben beschriebenen Sicherheitsvorschriften auch bei den Arbeitsschritten nach dem Schweißen berücksichtigen, da sich Zunder von den bearbeiteten und sich abkühlenden Werkstücken ablösen kann.



Sicherstellen, dass der Brenner abgekühlt ist, bevor daran Arbeiten oder Wartungen ausgeführt werden.



Sicherstellen, dass das Kühlaggregat ausgeschaltet ist, bevor die Leitungen für den Vor- und Rücklauf der Kühlflüssigkeit abgetrennt werden. Die austretende heiße Flüssigkeit kann schwere Verbrennungen verursachen.



Einen Verbandskasten griffbereit halten. Verbrennungen oder Verletzungen sind nicht zu unterschätzen.



Vor dem Verlassen des Arbeitsplatzes muss dieser gesichert werden, um Personen- und Sachschäden zu vermeiden.

1.3 Rauch- und Gasschutz



Rauch, Gas und Staub, die durch das Schweißverfahren entstehen, können gesundheitsschädlich sein. Der beim Schweißen entstehende Rauch kann unter bestimmten Umständen Krebs oder bei Schwangeren Auswirkungen auf das Ungeborene verursachen.

- Den Kopf fern von Schweißgasen und Schweißrauch halten.
- Im Arbeitsbereich für eine angemessene natürliche Lüftung bzw. Zwangsbelüftung sorgen.
- Bei ungenügender Belüftung sind Masken mit Atemgerät zu tragen.
- Wenn Schweißarbeiten in engen Räumen durchgeführt werden, sollte der Schweißer von einem außerhalb dieses Raums stehenden Kollegen beaufsichtigt werden.
- Wichtiger Hinweis: Keinen Sauerstoff für die Lüftung verwenden.
- Die Wirksamkeit der Absaugung überprüfen, indem die abgegebene Schadgasmenge regelmäßig mit den laut Sicherheitsvorschriften zulässigen Werten verglichen wird.
- Die Menge und Gefährlichkeit des erzeugten Schweißrauchs hängt vom benutzten Grundmaterial, vom Zusatzmaterial und den Stoffen ab, die man zur Reinigung und Entfettung der Werkstücke benutzt. Die Anweisungen des Herstellers und die entsprechenden technischen Datenblätter genau befolgen.
- Keine Schweißarbeiten in der Nähe von Entfettungs- oder Lackierarbeiten durchführen.
- Die Gasflaschen nur im Freien oder in gut belüfteten Räumen aufstellen.

1.4 Brand-/Explosionsverhütung



Das Schweißverfahren kann Feuer und/oder Explosionen verursachen.

- Alle entzündlichen bzw. brennbaren Stoffe oder Gegenstände aus dem Arbeitsbereich und aus dem umliegenden Bereich entfernen.
- Entzündliches Material muss mindestens 11m (35 Fuß) vom Ort, an dem geschweißt wird, entfernt sein oder entsprechend geschützt werden.
- Sprühende Funken und glühende Teilchen können leicht verstreut werden und benachbarte Bereiche auch durch kleine Öffnungen erreichen. Seien Sie beim Schutz von Personen und Gegenständen besonders aufmerksam.
- Keine Schweiß- oder Schneidarbeiten über oder in der Nähe von Druckbehältern ausführen.

- Keine Schweiß- oder Schneidarbeiten an geschlossenen Behältern oder Röhren durchführen. Beim Schweißen von Röhren oder Behältern besonders aufmerksam sein, auch wenn diese geöffnet, entleert und sorgfältig gereinigt wurden. Rückstände von Gas, Kraftstoff, Öl oder ähnlichen Substanzen können Explosionen verursachen.
- Nicht an Orten schweißen die explosive Staubteile, Gase oder Dämpfe enthalten.
- Nach dem Schweißen sicherstellen, dass der unter Spannung stehende Kreis nicht zufällig Teile berühren kann, die mit dem Massekreis verbunden sind.
- In der Nähe des Arbeitsbereichs Feuerlöschgerät platzieren.

1.5 Schutzmaßnahmen im Umgang mit Gasflaschen



Inertgasflaschen enthalten unter Druck stehendes Gas und können explodieren, wenn das Mindestmaß an Sicherheitsanforderungen für Transport, Lagerung und Gebrauch nicht gewährleistet ist.

- Die Gasflaschen müssen senkrecht an der Wand oder in anderen dafür vorgesehenen Vorrichtungen befestigt werden, damit sie nicht umfallen oder etwas anderes beschädigen können.
- Die Schutzkappe festschrauben, um das Ventil beim Transport, der Inbetriebnahme und nach Ende eines jeden Schweißvorgangs zu schützen.
- Die Flaschen weder direkter Sonneneinstrahlung noch hohen Temperaturschwankungen aussetzen. Die Flaschen dürfen keinen allzu niedrigen oder hohen Temperaturen ausgesetzt werden.
- Die Gasflaschen dürfen nicht mit offenem Feuer, elektrischen Lichtbögen, Brennern oder Schweißzangen und nicht mit beim Schweißen verspritzten glühenden Teilchen in Berührung kommen.
- Die Gasflaschen von Schweiß- und Stromkreisen im Allgemeinen fernhalten.
- Beim Öffnen des Ventils den Kopf fern von der Auslassöffnung des Gases halten.
- Das Ventil der Gasflasche immer schließen, wenn die Schweißarbeiten beendet sind.
- Niemals Schweißarbeiten an einer unter Druck stehenden Gasflasche ausführen.
- Eine Druckgasflasche darf nie direkt an den Druckminderer des Schweißgerätes angeschlossen werden! Der Druck kann die Kapazität des Druckminderers übersteigen, welcher deswegen explodieren könnte!

1.6 Schutz vor Elektrischem Schlag



Ein Stromschlag kann tödlich sein.

- Üblicherweise unter Spannung stehende Innen- oder Außenteile der gespeisten Schweißanlage nicht berühren (Brenner, Zangen, Massekabel, Elektroden, Draht, Rollen und Spulen sind elektrisch mit dem Schweißstromkreis verbunden).
- Die elektrische Isolierung der Anlage durch Benutzung trockener und ausreichend vom Erd- und Massepotential isolierter Flächen und Untergestelle sicherstellen.
- Sicherstellen, dass die Anlage an einer Steckdose und einem Stromnetz mit Schutzleiter korrekt angeschlossen wird.
- Achtung: Nie zwei Schweißbrenner oder zwei Schweißzangen gleichzeitig berühren.
- Die Schweißarbeiten sofort abbrechen, wenn das Gefühl eines elektrischen Schlags wahrgenommen wird.

1.7 Elektromagnetische Felder und Störungen



Der Strom, der durch die internen und externen Kabel der Anlage fließt, erzeugt in der unmittelbaren Nähe der Schweißkabel und der Anlage selbst ein elektromagnetisches Feld.

- Elektromagnetische Felder können die Gesundheit von Personen angreifen, die diesen langfristig ausgesetzt sind. (genaue Auswirkungen sind bis heute unbekannt).
- Elektromagnetische Felder können Störungen an Geräten wie Schrittmachern oder Hörgeräten verursachen.



Die Träger lebenswichtiger elektronischer Apparaturen (Schrittmacher) müssen die Genehmigung des Arztes einholen, bevor sie sich Verfahren wie Lichtbogenschweißen.

1.7.1 EMV in Übereinstimmung mit: EN 60974-10/A1:2015.

Klasse
B

Anlagen der Klasse B entsprechen den elektromagnetischen Kompatibilitätsanforderungen in Mischgebieten, einschließlich Wohngebieten, in denen die elektrische Leistung von dem öffentlichen Niederspannungsversorgungsnetz geliefert wird.

Klasse
A

Anlagen der Klasse A sind nicht für die Nutzung in Wohngebieten konzipiert, in denen die elektrische Leistung vom öffentlichen Niederspannungsversorgungsnetz geliefert wird. Es können potenzielle Schwierigkeiten beim Sicherstellen der elektromagnetischen Kompatibilität von Anlagen der Klasse A in diesen Umgebungen auftreten, aufgrund der ausgestrahlten Störgrößen.

Weitere Informationen finden Sie unter: LEISTUNGSSCHILDER oder TECHNISCHE DATEN.

1.7.2 Installation, Gebrauch und Bewertung des Bereichs

Dieses Gerät ist in Übereinstimmung mit den Angaben der harmonisierten Norm hergestellt EN 60974-10/A1:2015 und als Gerät der "KLASSE A" gekennzeichnet. Dieses Gerät darf nur für gewerbliche Zwecke im industriellen Umfeld angewendet werden. Der Hersteller haftet nicht für Schäden, die durch den Gebrauch der Anlage im Haushalt verursacht wurden.



Der Benutzer muss ein erfahrener Fachmann auf dem Gebiet sein und ist als solcher für die Installation und den Gebrauch des Geräts gemäß den Herstelleranweisungen verantwortlich. Wenn elektromagnetische Störungen festgestellt werden, muss der Benutzer des Gerätes das Problem lösen, wenn notwendig mit Hilfe des Kundendienstes des Herstellers.



In jedem Fall müssen die elektromagnetischen Störungen soweit reduziert werden, bis sie keine Belästigung mehr darstellen.



Bevor das Gerät installiert wird, muss der Benutzer die möglichen elektromagnetischen Probleme, die sich im umliegenden Bereich ergeben können, und insbesondere die Gesundheit, der sich in diesem Bereich aufhaltenden Personen - Träger von Schrittmachern und Hörgeräten - prüfen.

1.7.3 Anforderungen an die Netzversorgung

Hochleistungsanlagen können, aufgrund der Stromentnahme des Primärstroms aus der Netzversorgung, die Leistungsqualität des Netzes beeinflussen. Deshalb können Anschlussrichtlinien oder -anforderungen, unter Beachtung der maximal zulässigen Netzimpedanz (Z_{max}) oder der erforderlichen minimalen Netzkapazität (S_{sc}) an der Schnittstelle zum öffentlichen Netz (Netzübergabestelle) für einige Anlagentypen angewendet werden (siehe Technische Daten). In diesem Fall liegt es in der Verantwortung des Installateurs oder Betreibers der Anlage sicherzustellen, dass die Anlage angeschlossen werden darf, indem, falls notwendig, der Netzbetreiber konsultiert wird. Im Falle einer Störung können weitere Vorsichtsmaßnahmen notwendig sein; beispielsweise Filterung der Netzversorgung.

Es kann auch notwendig sein, das Versorgungskabel abzuschirmen.

Weitere Informationen finden Sie unter: TECHNISCHE DATEN.

1.7.4 Vorsichtsmaßnahmen für die Kabel

Um die Auswirkungen der elektromagnetischen Felder so gering wie möglich zu halten, sind folgende Maßnahmen zu treffen:

- Masse und Leistungskabel, wo möglich, zusammen verlegen und aneinander befestigen.
- Die Kabel nie um den Körper wickeln.
- Sich nicht zwischen Masse und Leistungskabel stellen (beide Kabel auf derselben Seite halten).
- Die Kabel müssen so kurz wie möglich sein, so dicht wie möglich beieinander liegen und am bzw. in der Nähe des Bodens verlaufen.
- Die Anlage in einem gewissen Abstand vom Bereich aufstellen, in dem geschweißt wird.
- Die Kabel müssen fern von anderen vorhandenen Kabeln verlegt sein.

1.7.5 Potentialausgleich

Der Erdanschluss aller Metallteile in der Schweißanlage (Schneidanlage) und in der Nähe derselben muss berücksichtigt werden. Die Vorschriften bezüglich des Potentialausgleiches beachten.

1.7.6 Erdung des Werkstücks

Wenn das Werkstück aus Gründen der elektrischen Sicherheit oder aufgrund seiner Größe und Lage nicht geerdet ist, könnte ein Erdanschluss des Werkstücks die Emissionen reduzieren. Es muss dringend beachtet werden, dass eine Erdung des Werkstücks weder die Unfallgefahr für den Bediener erhöhen noch andere elektrische Geräte beschädigen darf. Die Erdung muss gemäß den örtlichen Vorschriften erfolgen.

1.7.7 Abschirmung

Durch die selektive Abschirmung anderer Kabel und Geräte im umliegenden Bereich lassen sich die Probleme durch elektromagnetische Störungen reduzieren.

Die Abschirmung der gesamten Schweißanlage kann in besonderen Fällen in Betracht gezogen werden.

1.8 Schutzart IP



IP23S

- Gehäuse mit Schutz gegen Berührung gefährlicher Teile mit den Fingern und vor dem Eindringen von Fremdkörpern mit einem Durchmesser größer/gleich 12,5 mm.
- Gehäuse mit Schutz gegen Sprühwasser bis zu einem Winkel von 60° in Bezug auf die Senkrechte.
- Gehäuse mit Schutz gegen Schäden durch eindringendes Wasser, wenn die beweglichen Teile der Anlage im Stillstand sind.

1.9 Entsorgung



Das Elektrogerät nicht in den normalen Hausmüll geben!

Gemäß der europäischen Richtlinie 2012/19/EU über Elektro- und Elektronik-Altgeräte und der Umsetzung dieser Richtlinie in innerstaatliches Recht müssen die Geräte am Ende ihrer Nutzungsdauer getrennt gesammelt und einer Verwertungs- und Recyclingstelle zugeführt werden. Der Eigentümer des Geräts muss die autorisierten Sammelstellen durch Kontaktnahme der örtlichen Behörden in Erfahrung bringen. Durch die Einhaltung der Europäischen Richtlinie schützen Sie die Umwelt und die Gesundheit Ihrer Mitmenschen.

2. INSTALLATION



Die Installation darf nur von erfahrenem und vom Hersteller berechtigtem Personal ausgeführt werden.



Stellen Sie sicher, dass während der Installation der Generator vom Versorgungsnetz getrennt ist.



Die Zusammenschaltung mehrerer Generatoren (Reihen- oder Parallelschaltung) ist verboten.

2.1 Heben, Transportieren und Abladen

- Die Anlage ist mit einem Griff zur Beförderung von Hand versehen.
- Die Anlage hat keine speziellen Hebevorrichtungen.
- Einen Gabelstapler einsetzen und dabei sehr vorsichtig sein, um ein Umkippen des Generators zu vermeiden.



Das Gewicht der Anlage ist nicht zu unterschätzen, siehe Technische Daten.

Bewegen oder platzieren Sie die angehängte Last nicht über Personen oder Gegenständen.

Lassen Sie das Gerät/die Anlage nicht fallen und üben Sie keinen übermäßigen Druck auf die Anlage aus.

2.2 Aufstellen der Anlage



Folgende Vorschriften beachten:

- Sorgen Sie für freien Zugang zu den Bedienelementen und Anschlüssen.
- Stellen Sie die Anlage nicht in engen Räumen auf.
- Stellen Sie die Anlage nie auf einer Fläche mit einer Neigung von mehr als 10° auf.
- Stellen Sie die Anlage an einem trockenen und sauberen Ort mit ausreichender Belüftung auf.
- Schützen Sie die Anlage vor strömenden Regen und Sonne.

2.3 Elektrischer Anschluss



Der Generator ist mit einem Stromkabel für den Anschluss an das Stromnetz versehen.

Die Anlage kann gespeist werden mit:

- 400V dreiphasig
- 230V dreiphasig

Der Betrieb des Geräts wird für Spannungsabweichungen vom Nennwert bis zu $\pm 15\%$ garantiert.



Um Schäden an Personen oder der Anlage zu vermeiden, müssen vor dem Anschluss des Geräts an das Stromnetz die gewählte Netzspannung und die Sicherungen kontrolliert werden. Weiterhin ist sicher zu stellen, dass das Kabel an eine Steckdose mit Schutzleiterkontakt angeschlossen wird.



Die Anlage kann mit einem Generatorsatz gespeist werden. Voraussetzung ist, dass dieser unter allen möglichen Betriebsbedingungen und bei vom Generator abgegebener Höchstleistung eine stabile Versorgungsspannung gewährleistet, mit Abweichungen zum vom Hersteller erklärten Spannungswert von $\pm 15\%$. Gewöhnlich wird der Gebrauch von Generatorsätzen empfohlen, deren Leistung bei einphasigem Anschluss 2mal und bei dreiphasigem Anschluss 1,5mal so groß wie die Generatorleistung ist. Der Gebrauch elektronisch gesteuerter Generatorsätze wird empfohlen.



Zum Schutz der Benutzer muss die Anlage korrekt geerdet werden. Das Versorgungskabel ist mit einem gelb-grünen Schutzleiter versehen, der mit einem Stecker mit Schutzleiterkontakt verbunden werden muss. Dieser gelb/grüne Leiter darf ausschließlich als Schutzleiter verwendet werden. Prüfen, ob die verwendete Anlage geerdet ist und ob die Steckdose/n in gutem Zustand sind. Nur zugelassene Stecker montieren, die den Sicherheitsvorschriften entsprechen.



Der elektrische Anschluss muss gemäß den am Installationsort geltenden Gesetzen von qualifizierten Technikern, die eine spezifische Ausbildung nachweisen können, ausgeführt werden.

2.4 Inbetriebnahme

2.4.1 Anschluss für E-Hand-Schweißen



Der Anschluss in der Abbildung ergibt eine Schweißung mit umgekehrter Polung.
Um eine Schweißung mit direkter Polung zu erhalten, muss der Anschluss umgekehrt werden.

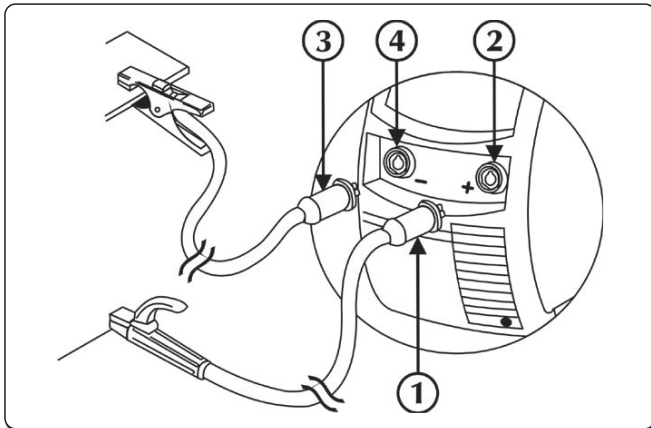

- ① Verbinder der Erdungszange
- ② Negative Leistungsbuchse (-)
- ③ Verbinder der Elektrodenhalter-Zange
- ④ Positive Leistungsbuchse (+)

- ▶ Den Verbinder der Erdungszange an die Steckdose des Minuskabels (-) des Generators anschließen. Den Stecker einstecken und im Uhrzeigersinn drehen, bis alle Teile fest sind.
- ▶ Den Verbinder der Schweißzange an die Steckdose des Pluskabels (+) des Generators anschließen. Den Stecker einstecken und im Uhrzeigersinn drehen, bis alle Teile fest sind.

2.4.2 Anschluss für WIG-Schweißen

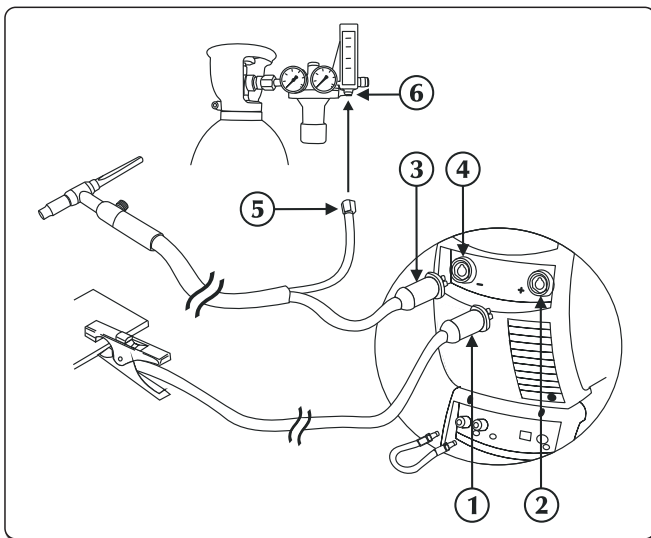



- ① Verbinder der Erdungszange
- ② Positive Leistungsbuchse (+)
- ③ WIG-Brenneranschluss
- ④ Steckdose brenner
- ⑤ Gasleitungsanschluss
- ⑥ Druckreduzierer verschrauben

- ▶ Den Verbinder der Erdungszange an die Steckdose des Pluskabels (+) des Generators anschließen. Den Stecker einstecken und im Uhrzeigersinn drehen, bis alle Teile fest sind.
- ▶ Den Anschluß der WIG-Schweißbrenner in die Steckdose der Schweißbrenner des Generators stecken. Den Stecker einstecken und im Uhrzeigersinn drehen, bis alle Teile fest sind.





Der Schutzgasstrom wird mittels eines Hahns reguliert, der sich im Allgemeinen am Schweißbrenner befindet.

- ▶ Den Verbinder des Brennergasschlauchs separat an die Gaszufuhr anschließen.
- ▶ Den roten Schlauch (Rücklauf der Kühlflüssigkeit) des Brenners mit dem entsprechenden Schnellverbinder (rot - Symbol - ) verbinden.
- ▶ Den blauen Schlauch (Vorlauf der Kühlflüssigkeit) des Brenners mit dem entsprechenden Schnellverbinder (blau - Symbol - ) verbinden.

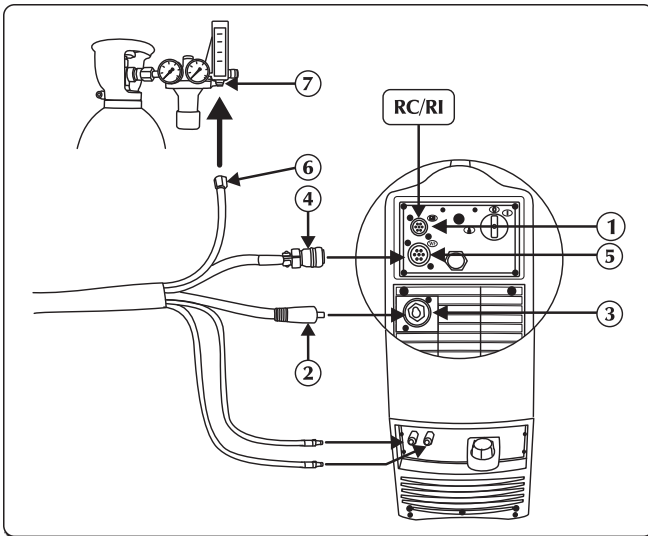
2.4.3 Anschluss für MIG/MAG-Schweißen



- ① Eingang CAN-BUS-Signalkabel
- ② Leistungskabel
- ③ Positive Leistungsbuchse (+)
- ④ Signalkabel
- ⑤ Signalkabeleingang (CAN-BUS) (Kabelstrang)
- ⑥ Brennergas
- ⑦ Gasversorgungsanschluss

- ▶ Das Leistungskabel mit entsprechender Ausgangsbuchse verbinden. Den Stecker einstecken und im Uhrzeigersinn drehen, bis alle Teile fest sind.
- ▶ Das Signalkabel des Schlauchpaketes mit dem entsprechenden Anschluss verbinden. Den Stecker einstecken und die Schraubverriegelung im Uhrzeigersinn drehen, bis alle Teile ganz fest sind.
- ▶ Den Gasschlauch des Schlauchpaketes mit dem Druckminderer der Gasflasche oder dem Anschluss der Gasleitung verbinden. Den Gasdurchfluss auf einen Wert zwischen 10 und 30 l/min einstellen.
- ▶ Den blauen Schlauch des Schlauchpaketes mit dem entsprechenden Schnellverbinder für den Rücklauf der Kühlflüssigkeit (blau - Symbol - ) verbinden.
- ▶ Den roten Schlauch des Schlauchpaketes mit dem entsprechenden Schnellverbinder für den Rücklauf der Kühlflüssigkeit (rot - Symbol - ) verbinden.

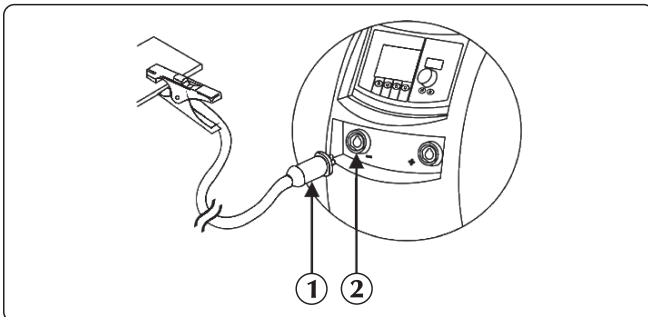

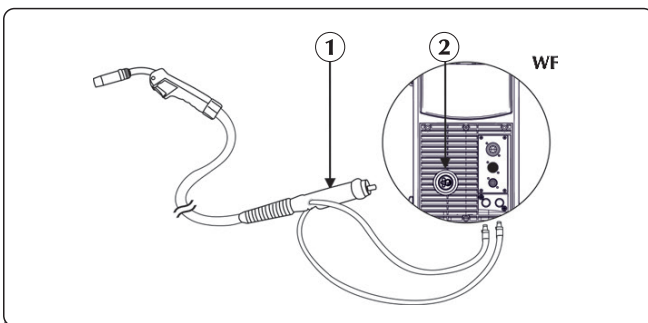

- ① Verbinder der Erdungszange
- ② Negative Leistungsbuchse (-)

- ▶ Den Verbinder der Erdungszange an die Steckdose des Minuskabels (-) des Generators anschließen. Den Stecker einstecken und im Uhrzeigersinn drehen, bis alle Teile fest sind.



- ① Brenneranschluss
- ② Verbinder

- ▶ Den blauen Schlauch (Vorlauf der Kühlflüssigkeit) des Brenners mit dem entsprechenden Schnellverbinder (blau - Symbol - ) verbinden.
- ▶ Den roten Schlauch (Rücklauf der Kühlflüssigkeit) des Brenners mit dem entsprechenden Schnellverbinder (rot - Symbol - ) verbinden.
- ▶ Den MIG/MAG-Brenner mit dem Anschluss verbinden, dabei sicherstellen, dass die Schraubverriegelung fest angeschraubt ist.

3. PRÄSENTATION DER ANLAGE

3.1 Hintere Tafel

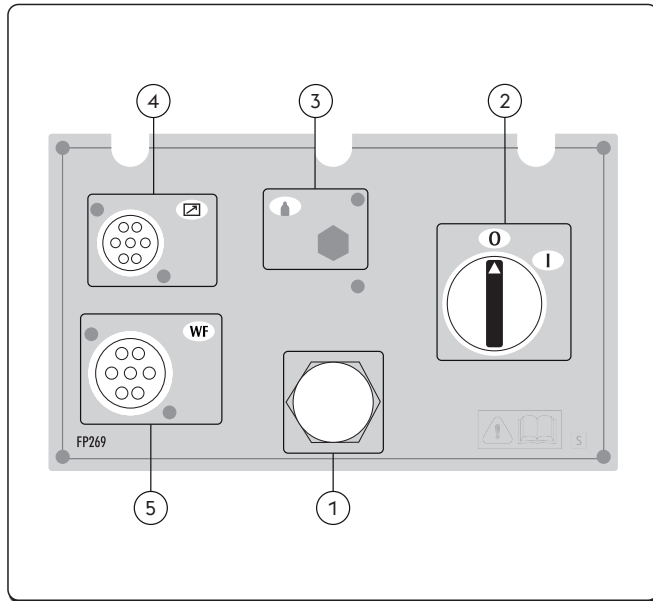

- ① **Netzkabel**
Für den Netzanschluss und die Speisung der Anlage.
- ② **Hauptschalter**
Schaltet die elektrische Leistung der Anlage ein. Er verfügt über zwei Positionen: "O" AUS; "I" EIN.
- ③ **Nicht benutzt**
- ④ **Eingang CAN-BUS-Signalkabel (RC, RI...)**
- ⑤ **Signalkabeleingang (CAN-BUS) (Kabelstrang)**

3.2 Buchsenfeld

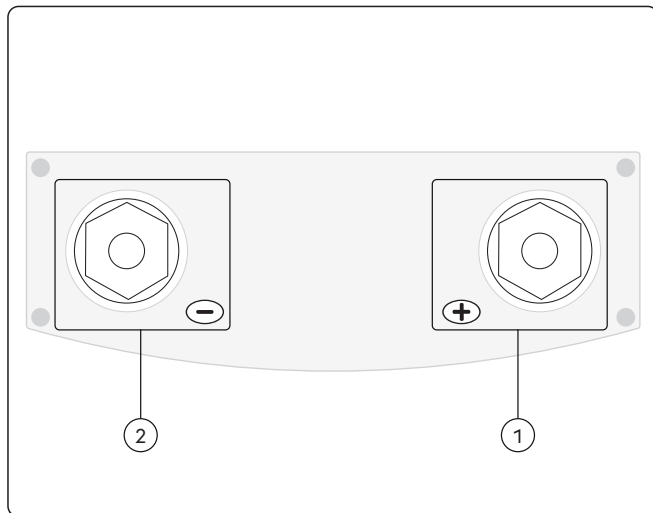

- ① **Positive Leistungsbuchse (+)**

Prozess MMA:	Elektrodenbrenner verbindung
Prozess WIG:	Erdung kabel verbindung
- ② **Negative Leistungsbuchse (-)**

Prozess MMA:	Erdung kabel verbindung
Prozess WIG:	Brenner verbindung
Prozess MIG/MAG:	Erdung kabel verbindung

3.3 Frontbedienfeld

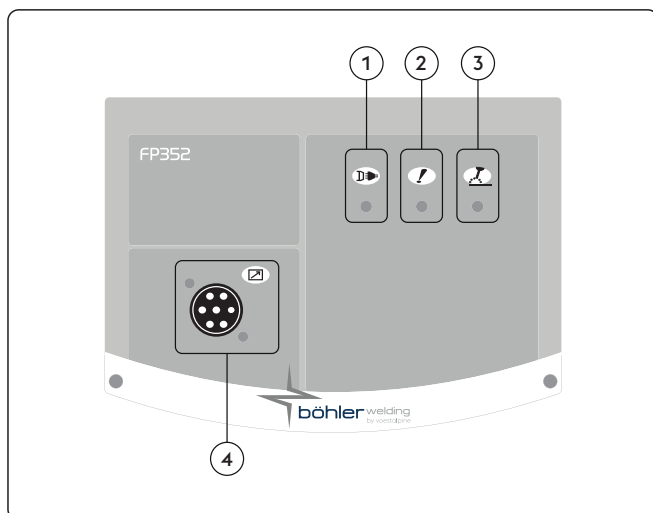





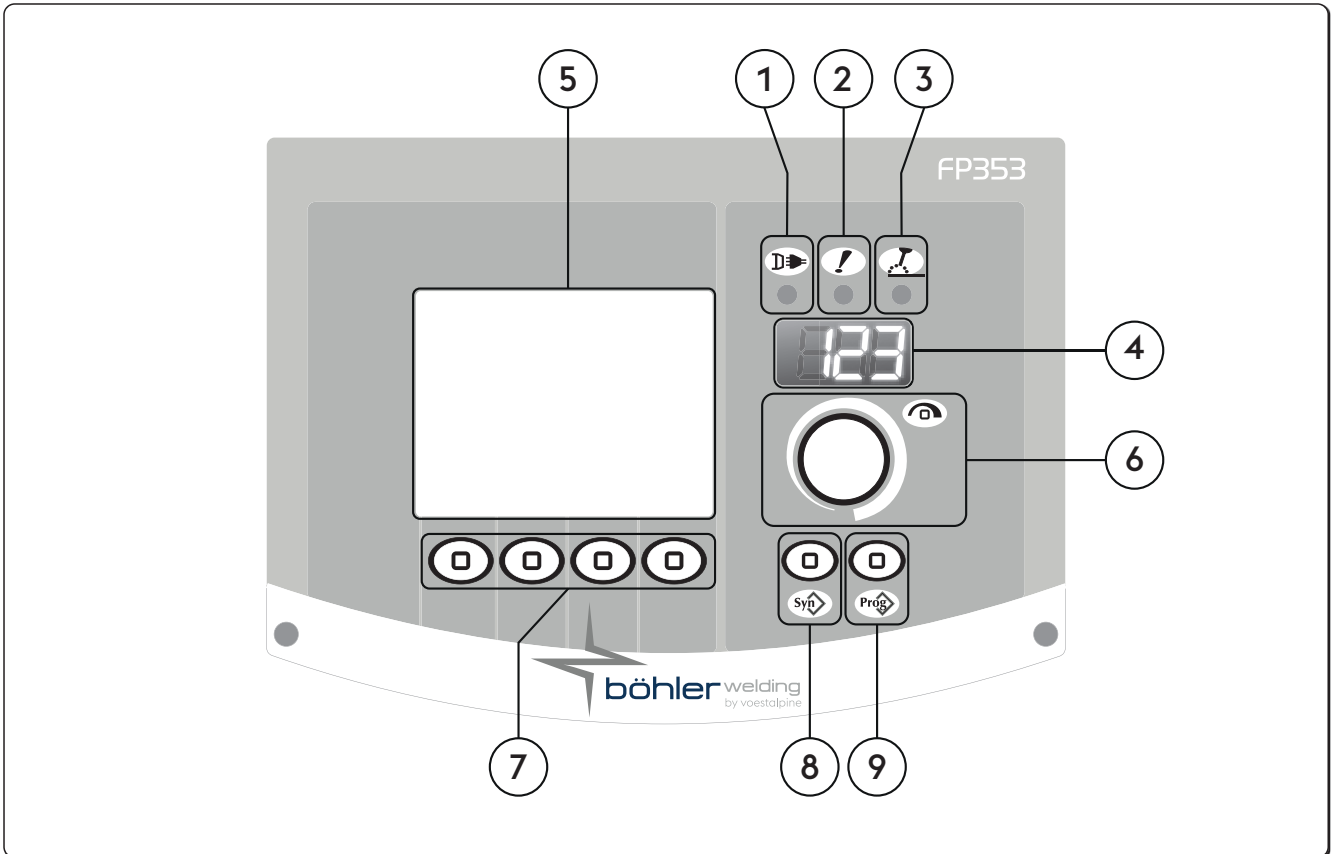

- ① **LED Versorgung**
Zeigt an, dass die Anlage an die Stromversorgung angeschlossen und eingeschaltet ist.
- ② **LED Allgemeiner Alarm**
Zeigt den möglichen Eingriff von Schutzeinrichtungen an, z. B. Temperaturschutz.
- ③ **LED Aktive Leistung**
Zeigt an, dass an den Ausgangsklemmen der Anlage Spannung anliegt.
- ④ **Eingang CAN-BUS-Signalkabel (RC, RI...)**

DE

3.4 Frontbedienfeld



DE

- ①  **LED Versorgung**
Zeigt an, dass die Anlage an die Stromversorgung angeschlossen und eingeschaltet ist.
- ②  **LED Allgemeiner Alarm**
Zeigt den möglichen Eingriff von Schutzeinrichtungen an, z. B. Temperaturschutz.
- ③  **LED Aktive Leistung**
Zeigt an, dass an den Ausgangsklemmen der Anlage Spannung anliegt.
- ④  **7-Segment-Anzeige**
Ermöglicht die Anzeige allgemeiner Geräteparameter während des Startens; Ablesen von Einstellungen, Strom und Spannung während des Schweißens und die Anzeige von Fehlercodes.
- ⑤  **LCD Display**
Ermöglicht die Anzeige allgemeiner Geräteparameter während des Startens; Ablesen von Einstellungen, Strom und Spannung während des Schweißens und die Anzeige von Fehlercodes.
Ermöglicht die verzögerungsfreie Anzeige aller Vorgänge.
- ⑥  **Hauptregler**
Ermöglicht den Zugang zum Setup, die Auswahl und Einstellung der Schweißparameter.
- ⑦  **Funktionstasten**
Ermöglicht die Auswahl der verschiedenen Funktionen der Anlage:
- Schweißverfahren E-Hand
- Schweißmethoden
- Impulsstrom
- Grafikmodus

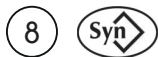

8 Programmtaste

Ermöglicht die Auswahl eines voreingestellten Schweißprogramms über die Auswahl einiger einfacher Informationen:

- Drahttyp
- Art des Gases
- Drahtdurchmesser



9 Job-Taste

Ermöglicht das Speichern und Verwalten von 240 Schweißprogrammen, die vom Bediener personalisiert werden können.

4. VERWENDUNG VON GERÄTEN

4.1 Startbildschirm

Wenn der Generator eingeschaltet wird, führt er eine Abfolge von Überprüfungen durch, um das korrekte Arbeiten der Anlage und aller angeschlossenen Geräte zu gewährleisten. An dieser Stelle wird auch der Gastest durchgeführt, um den richtigen Anschluss der Gaszufuhr zu prüfen.

4.2 Test-Anzeige

Wenn das Seitenpaneel (Spulenteil) geöffnet ist, sind Schweißarbeiten verboten. Die Test-Anzeige erscheint im LCD-Display.

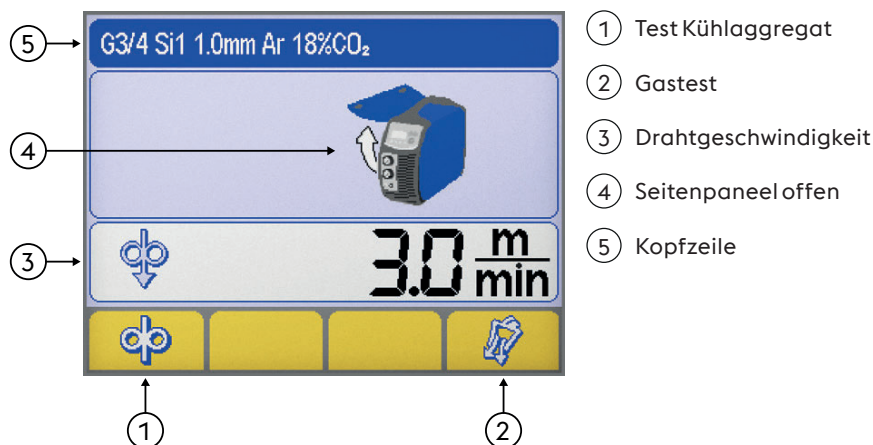

Test Kühlaggregat

Ermöglicht den manuellen Drahtvorschub ohne Gasdurchfluss und ohne dass Spannung am Draht anliegt. Ermöglicht die Einführung des Drahtes in die Drahtführungsspirale des Schweißbrenners in der Schweißvorbereitungsphase.



Gastest

Ermöglicht die Reinigung des Schutzgaskreises und die Durchführung der entsprechenden Einstellungen des Schutzgasdrucks und -durchflusses bei abgeschalteter Leistung.



Drahtvorschubgeschwindigkeit

Ermöglicht die Einstellung der Drahtvorschubgeschwindigkeit (Während der Ladephase).

Minimum	Maximal	Standard
0.5 m/min	22.0 m/min	3.0 m/min



Seitenpaneel offen



Kopfzeile

Ermöglicht die Anzeige bestimmter wichtiger Informationen in Bezug auf das gewählte Verfahren.

4.3 Haupt-Menü

Ermöglicht die Steuerung der Anlage und des Schweißverfahrens und zeigt die Haupteinstellungen an.

4.4 Hauptbildschirmseite des E-Handschweißprozesses

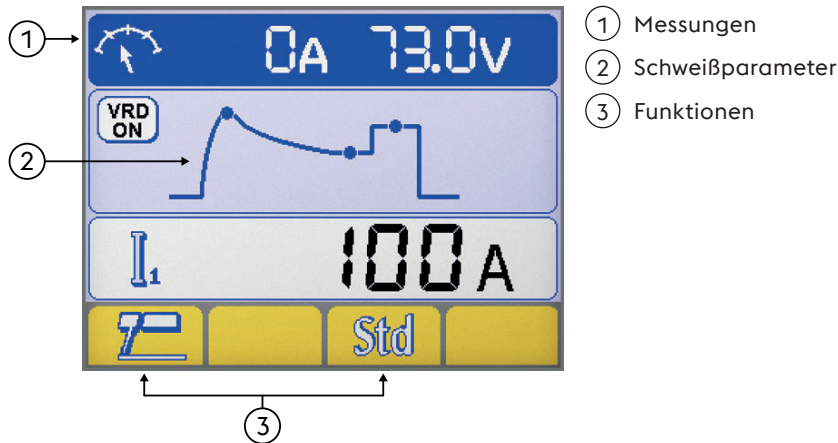

Messungen

Während der Schweißarbeiten werden der Ist-Strom und die Ist-Spannung im LCD-Display angezeigt.

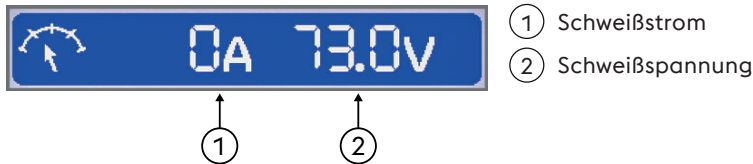

Schweißparameter

► Wählen Sie den gewünschten Parameter aus, indem Sie den Taster Encoder drücken.

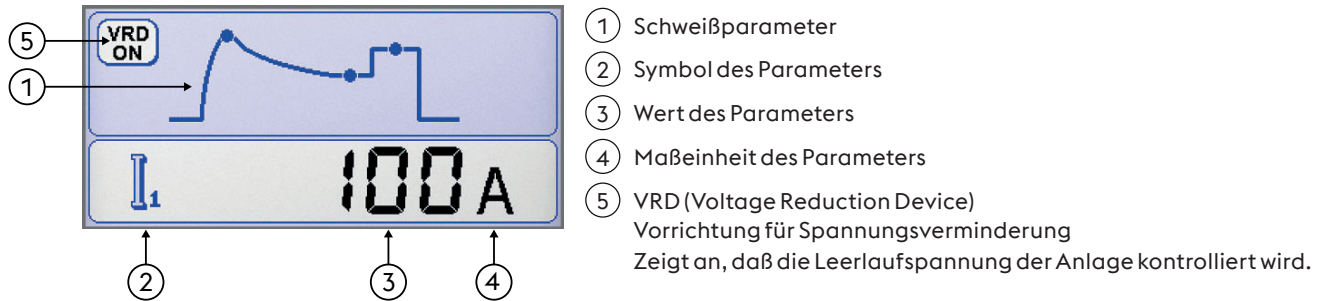

Funktionen

Ermöglicht das Einstellen der wichtigsten Funktionen des Schweißverfahrens und der Schweißmethoden.



Schweißverfahren E-Hand



DE



Synergie MMA

Zur Einstellung der optimalen Bogendynamik und zur Auswahl der benutzten Elektrode. Mit der Wahl der richtigen Bogendynamik kann der maximale Nutzen des Generators erzielt werden mit der Absicht die bestmögliche Schweißleistung zu erreichen.

Standard (Basisch/Rutil)	Cellulose	Stahl	Aluminium	Guss

Perfekte Schweißfähigkeit der verwendeten Elektrode wird nicht garantiert
Die Schweißfähigkeit hängt ab von der Qualität des Verbrauchsmaterials und dessen Aufbewahrung, den Arbeits- und Schweißbedingungen, den zahlreichen Einsatzmöglichkeiten.

DE

4.5 Hauptbildschirmseite des WIG

① Messungen
② Schweißparameter
③ Funktionen

Messungen

Während der Schweißarbeiten werden der Ist-Strom und die Ist-Spannung im LCD-Display angezeigt.

① Schweißstrom
② Schweißspannung

Schweißparameter

① Schweißparameter
▶ Wählen Sie den gewünschten Parameter aus, indem Sie den Taster Encoder drücken.
▶ Stellen Sie den Wert des gewählten Parameters ein, indem Sie den Encoder drehen.
② Symbol des Parameters
③ Wert des Parameters
④ Maßeinheit des Parameters

Funktionen

Ermöglicht das Einstellen der wichtigsten Funktionen des Schweißverfahrens und der Schweißmethoden.

① Schweißverfahren E-Hand

Schweißverfahren E-Hand



4.6 Hauptbildschirmseite des MIG/MAG-Prozesses

Basisbildschirmseite

① Kopfzeile Mig/MAG
 ② Schweißparameter
 ③ Funktionen

Grafikbildschirmseite

① Kopfzeile Mig/MAG
 ② Schweißparameter
 ③ Funktionen

Kopfzeile Mig/MAG

Ermöglicht die Anzeige bestimmter wichtiger Informationen in Bezug auf das gewählte Verfahren.

① G3/4 Si1 ② 1.0mm ③ Ar 18%CO₂

Gewählte Synergiekurve

- ① Art des Zusatzmaterials
- ② Drahtdurchmesser
- ③ Art des Gases

① I 118A ② 2.2mm ③ 3.4mm ④ V 19.5V

Schweißparameter

- ① Schweißstrom
- ② Werkstückdicke
- ③ Kehlnaht
- ④ Schweißspannung

DE

Schweißparameter (Basisbildschirmseite)

► Wählen Sie den gewünschten Parameter aus, indem Sie den Taster Encoder drücken.

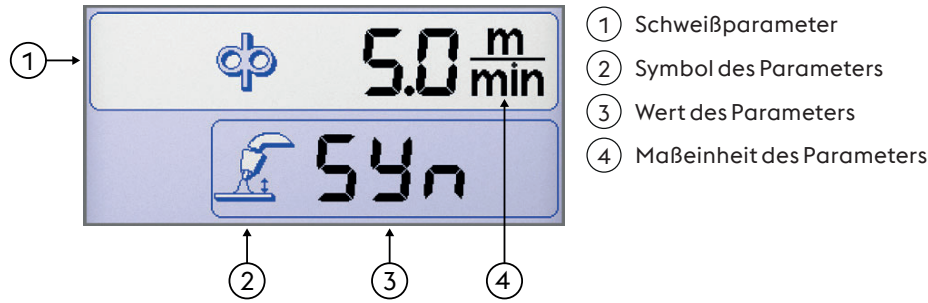

Schweißparameter (Grafikbildschirmseite)

► Wählen Sie den gewünschten Parameter aus, indem Sie den Taster Encoder drücken.

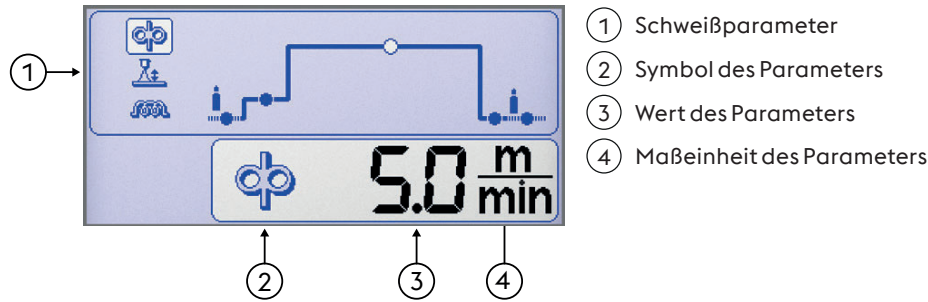

Funktionen

Ermöglicht das Einstellen der wichtigsten Funktionen des Schweißverfahrens und der Schweißmethoden.

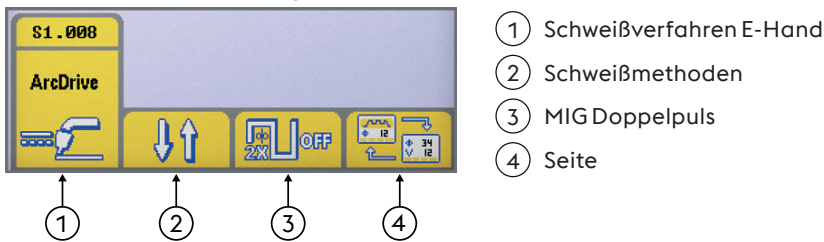

Schweißverfahren E-Hand

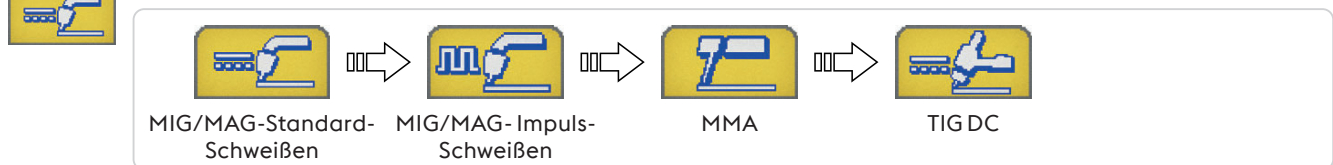

Schweißmethoden

Ermöglicht die Auswahl der Schweißmethode



2-Taktbetrieb, in zwei Stufen

Drücken des Tasters startet den Gasdurchfluss, speist den Draht mit Spannung und startet den Drahtvorschub;

beim Loslassen des Tasters werden Gas, Spannung und Drahtvorschub abgestellt.



4-Taktbetrieb, in vier Stufen

Das erste Drücken des Tasters startet den Gasdurchfluss mit manueller Gasvorströmzeit. Loslassen des Tasters legt Spannung an den Draht und startet den Vorschub. Das erneute Drücken des Tasters stoppt den Drahtvorschub und setzt den Strom zurück auf Null. Abschließendes Loslassen des Tasters beendet den Gasdurchfluss.



Hotstart und Endkraterstrom

Ermöglicht Schweißen in drei verschiedenen Leistungsstufen, die direkt vom Schweißer gewählt und gesteuert werden können, indem er den Brenntaster betätigt.

Das erste Drücken des Tasters startet den Gasdurchfluss, legt Spannung an den Draht und startet den Vorschub mit der Geschwindigkeit, die im Parameter „Drahteinschleichen“ (während des Setup) eingestellt ist und mit den relativen Synergie-Werten der Schweißparameter festgelegt wurde.

Wenn der Brenntaster losgelassen wird, ändern sich die Werte für die Drahtvorschubgeschwindigkeit und die relativen synergischen Parameter automatisch in die Grundwerte, die am Bedienfeld eingestellt sind.

Das erneute Drücken des Brenntasters bringt die Werte der Drahtgeschwindigkeit und der relativen synergischen Parameter auf die während des Setups voreingestellten Werte der Parameter des Endkraterfüllers. Loslassen des Brenntasters stoppt den Drahtvorschub und liefert die Leistung für die Drahrückbrand- und Gasnachströmphase.



MIG Doppelpuls



Doppel-Impuls nicht aktiviert



Doppel-Impuls aktiviert



Seite

Ermöglicht den Wechsel der Anzeige zwischen:



Basisbildschirmseite



Grafikbildschirmseite

Synergiekurven-Menü



Synergie

Ermöglicht die Auswahl eines voreingestellten Schweißprogramms (Synergie) über die Auswahl einiger einfacher Informationen

Wahl des Schweißprozesses

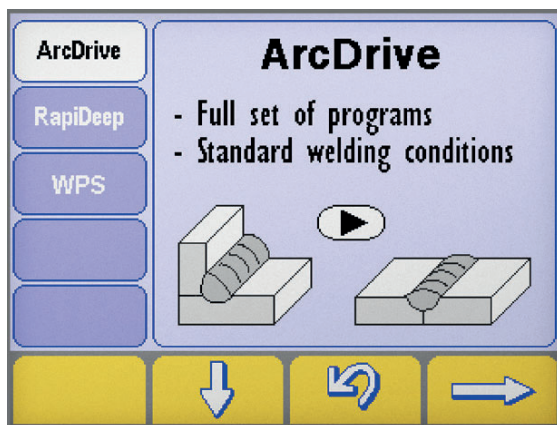

- ▶ Die Bildschirmseite „Synergien“ durch Drücken der Taste für mindestens eine Sekunde aufrufen.
- ▶ Den gewünschten Schweißprozess mit den Tasten wählen und .
- ▶ Drücken Sie die Taste um zum nächsten Schritt zu gelangen.



Schweißverfahren E-Hand

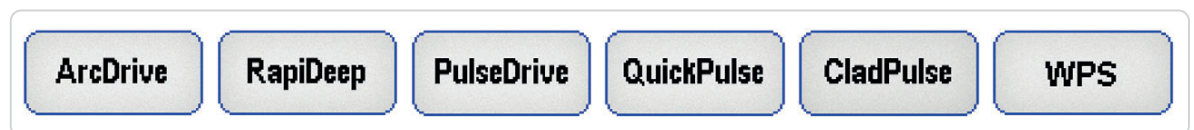

Wahlbildschirmseite der Synergie Materialtyp/Gasart

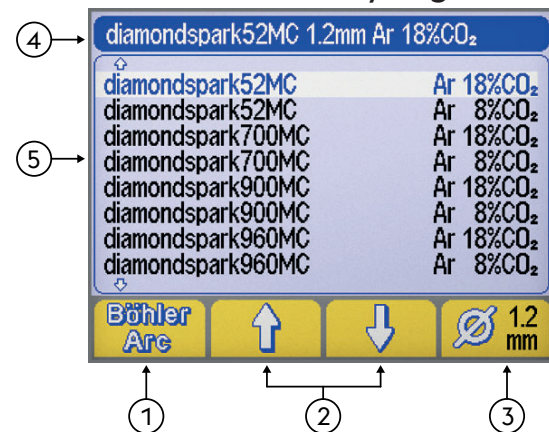

- ① Schweißprogramm (BöhlerArc/UniversalArc)
- ② Material-/Gaswahl
- ③ Drahtdurchmesser
- ④ Kopfzeile
- ⑤ Schweißprogramm



Schweißprogramm

Ermöglicht die Auswahl der Schweißprogramm



BöhlerArc



UniversalArc



Material-/Gaswahl

Ermöglicht die Auswahl von:



- Art des Zusatzmaterials
- Art des Gases



Drahtdurchmesser

Ermöglicht die Wahl des verwendeten Drahtdurchmessers (mm).

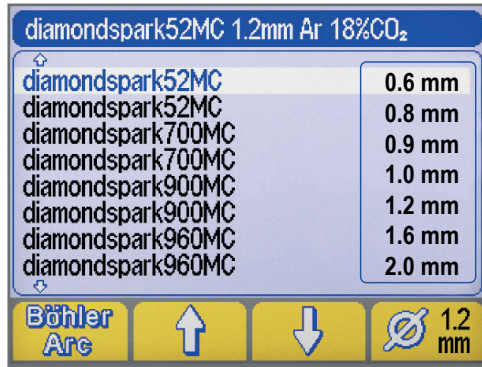

① Drahtdurchmesser

①



Kopfzeile

Ermöglicht die Anzeige bestimmter wichtiger Informationen in Bezug auf das gewählte Verfahren.



NO PROGRAM

Zeigt an, dass die gewählte Synergiekurve nicht verfügbar oder mit den anderen Einstellungen der Anlage nicht vereinbar ist.

4.7 Programm-Menü



Ermöglicht das Speichern und Verwalten von 240 Schweißprogrammen, die vom Bediener personalisiert werden können.

Programme (JOB)

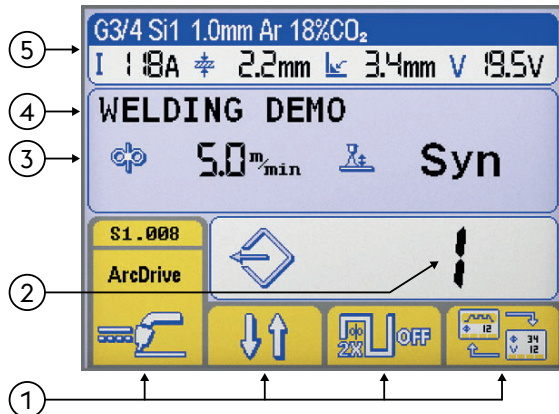

- ① Funktionen
- ② Nummer des gewählten Programms
- ③ Hauptparameter des gewählten Programms
- ④ Benennung des gewählten Programms
- ⑤ Kopfzeile

Kapitel "Haupt-Menü" einsehen

Programm-Speicher

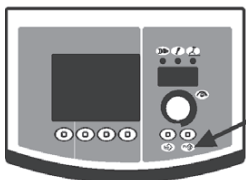

► Gehen Sie in das Menü "Programm speichern" hinein, indem Sie die Taste. für mindestens eine Sekunde aufrufen.



► Wählen Sie das gewünschte Programm (oder den freien Speicherplatz), indem Sie den Encoder drehen.

--- Speicher leer



Programm gespeichert

► Brechen Sie den Vorgang ab, indem Sie die Taste drücken. .

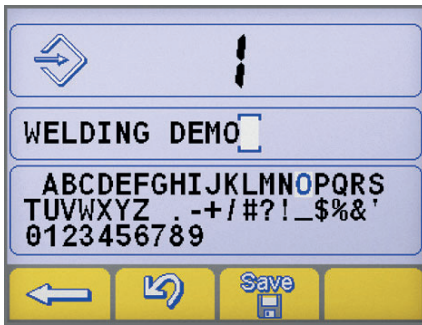
► Speichern Sie alle aktuellen Einstellungen im gewählten Programm, indem Sie die Taste drücken. .





Geben Sie einen Namen für das Programm ein.

- ▶ Wählen Sie den gewünschten Buchstaben, indem Sie den Encoder drehen.
- ▶ Speichern Sie den gewählten Buchstaben, indem Sie den Taster Encoder drücken.
- ▶ Löschen Sie das letzte Zeichen, indem Sie die Taste drücken. .
- ▶ Brechen Sie den Vorgang ab, indem Sie die Taste drücken. .
- ▶ Bestätigen Sie den Vorgang, indem Sie die Taste drücken .





Das Speichern eines neuen Programms auf einem bereits belegten Speicherplatz erfordert das Löschen des Speicherplatzes durch einen vorgeschriebenen Ablauf.

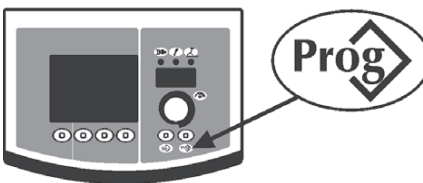

- ▶ Brechen Sie den Vorgang ab, indem Sie die Taste drücken. .
- ▶ Löschen Sie das ausgewählte Programm, indem Sie die Taste drücken. .
- ▶ Setzen Sie den Speichervorgang fort.

Programmabruf





- ▶ Durch Drücken der Taste rufen Sie das 1 verfügbare Programm auf .
- ▶ Wählen Sie das gewünschte Programm, indem Sie den Encoder drehen.
- ▶ Wählen Sie das gewünschte Programm aus, indem Sie die Taste drücken. .





Nur die belegten Programmspeicherplätze werden angezeigt, während die leeren automatisch übersprungen werden.

Programm löschen

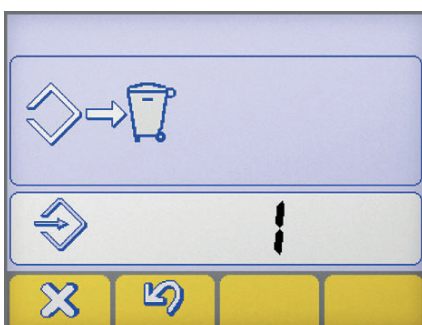

- ▶ Wählen Sie das gewünschte Programm, indem Sie den Encoder drehen.
- ▶ Löschen Sie das ausgewählte Programm, indem Sie die Taste drücken. .
- ▶ Brechen Sie den Vorgang ab, indem Sie die Taste drücken. .



- ▶ Brechen Sie den Vorgang ab, indem Sie die Taste drücken. .
- ▶ Löschen Sie das ausgewählte Programm, indem Sie die Taste drücken. .

5. SETUP

5.1 Setup und Parametereinstellung

Ermöglicht die Einstellung und Regelung einer Reihe Zusatzparameter, um die Schweißanlage besser und präziser betreiben zu können.

Die im Setup vorhandenen Parameter sind nach dem gewählten Schweißprozess geordnet und haben eine Nummerncodierung.

Zugriff auf Setup



- ▶ Erfolgt, indem 5 Sek. lang auf die Taste Encoder gedrückt wird
- ▶ Der Zugriff wird durch den Eintrag 0 am Display bestätigt.

DE

Auswahl und Einstellung des gewünschten Parameters

- ▶ Erfolgt durch Drehen des Encoders bis zur Anzeige des Nummerncodes des gewünschten Parameters.
- ▶ Durch Drücken der Taste Encoder wird nun der für den gewählten Parameter eingestellte Wert sichtbar und kann reguliert werden.

Verlassen des Setup

- ▶ Um den Abschnitt „Einstellungen“ zu verlassen, erneut auf die Taste Encoder drücken.
- ▶ Um das Setup zu verlassen, auf Parameter "0" (Speichern und Beenden) gehen und erneut auf die Taste Encoder drücken.
- ▶ Brechen Sie den Vorgang ab, indem Sie die Taste drücken .
- ▶ Zum Speichern der Änderungen und Verlassen des Setups folgende Taste drücken: .

5.1.1 Liste der Setup-Parameter (E-Hand-Schweißen)

0

Speichern und Beenden

Für das Speichern der Änderungen und Verlassen des Setup.



1

Reset

Für die Rücksetzung aller Parameter auf die Standardwerte.



3

Hot start

Für die Einstellung des Hot-Start-Wertes beim E-Hand-Schweißen.

Ermöglicht einen verstellbaren Hot-Start-Wert der Zündphasen des Bogens und erleichtert die Startvorgänge.



Basisch elektroden

Minimum	Maximal	Standard
0/aus	500%	80%

Zellulose elektroden

Minimum	Maximal	Standard
0/aus	500%	150%

CrNi-elektroden

Minimum	Maximal	Standard
0/aus	500%	100%

Aluminiumelektrode

Minimum	Maximal	Standard
0/aus	500%	120%

Gusseisenelektrode

Minimum	Maximal	Standard
0/aus	500%	100%

7

Schweißstrom

Ermöglicht die Einstellung des Schweißstroms.



Minimum	Maximal	Standard
3 A	Imax	100 A

8 Arc force



Für die Einstellung des Arc-Force-Wertes beim E-Hand-Schweißen.
Ermöglicht die Dynamikkorrektur des Bogens (plus oder minus) während des Schweißens. Dadurch wird die Arbeit des Schweißers erleichtert.

Ein Anheben des Wertes der Bogenstärke verringert das Risiko des Festklebens der Elektrode.

Basisch elektroden

Minimum	Maximal	Standard
0/aus	500%	30%

Zellulose elektroden

Minimum	Maximal	Standard
0/aus	500%	350%

CrNi-elektroden

Minimum	Maximal	Standard
0/aus	500%	30%

Aluminiumelektrode

Minimum	Maximal	Standard
0/aus	500%	100%

Gusseisenelektrode

Minimum	Maximal	Standard
0/aus	500%	70%

204 Dynamic power control (DPC)



Ermöglicht, die gewünschte U/I - Charakteristik auszuwählen.

I=C Konstanter Strom

Die Vergrößerung oder Reduzierung der Bogenhöhe hat keine Auswirkung auf den erforderlichen Schweißstrom.

Empfohlen für Elektrode: Basisch, Rutil, Sauer hohe, Stahl, Guss

1:20 Reduzierungscharakteristik mit Rampenregelung

Das Ansteigen der Bogenhöhe verursacht eine Reduzierung des Schweißstroms (und umgekehrt) entsprechend dem festen Wert von 1/20 Ampere pro Volt.

Empfohlen für Elektrode: Cellulose, Aluminium

P=C Konstante Leistung

Das Ansteigen der Bogenhöhe verursacht eine Reduzierung des Schweißstroms (und umgekehrt) entsprechend der Regel: $V \cdot I = K$

Empfohlen für Elektrode: Cellulose, Aluminium

312 Bogenabtrennspannung



Zur Einstellung des Spannungswertes, bei dem das Abtrennen des Schweißbogens erzwungen werden soll.

Verbessert den Umgang mit verschiedenen auftretenden Betriebsbedingungen.

Beim Punktschweißen zum Beispiel reduziert eine niedrige Bogenabtrennspannung die erneute Zündung des Bogens beim Entfernen der Elektrode vom Werkstück, vermindert Spritzer, Verbrennungen und Oxidation des Werkstücks.

Wenn Elektroden benutzt werden, die hohe Spannungen erfordern, sollte dagegen ein hoher Grenzwert eingestellt werden, um Bogenabtrennungen beim Schweißen zu verhindern.



Niemals eine Bogenabtrennspannung einstellen, die größer als die Leerlaufspannung des Generators ist.

Basisch elektroden

Minimum	Maximal	Standard
0/aus	99.9 V	57.0 V

Zellulose elektroden

Minimum	Maximal	Standard
0/aus	99.9 V	70.0 V

399 Schweißgeschwindigkeit



Ermöglicht die Einstellung der Ausführungsgeschwindigkeit der Schweißarbeit.

Default cm/min: Bezugsgeschwindigkeit für manuelles Schweißen.

Syn: Sinergic Wert.

Minimum	Maximal	Standard
1 cm/min	200 cm/min	15 cm/min

500 Maschineneinstellung



Ermöglicht die Auswahl der erforderlichen Grafikschnittstelle.

Ermöglicht den Zugang zu höheren Setup Levels.

Siehe Abschnitt "Interface-Personalisierung (Set up 500)"

Wert	Benutzeroberfläche
XE	Modus Easy
XA	Modus Advanced
XP	Modus Professional

Wert	Ausgewählte Ebene
USER	Bediener
SERV	Service
vaBW	vaBW

DE

DE

551 Lock/unlock
 Ermöglicht das Sperren der Bedienfelder und die Einführung eines Schutzcodes.
 Siehe Abschnitt "Lock/unlock (Set up 551)".

552 Lautstärke der akustischen Warnvorrichtung
 Zur Einstellung der Lautstärke der akustischen Warnvorrichtung.

Minimum	Maximal	Standard
0/aus	10	10

601 Schrittweite
 Ermöglicht die Regulierung eines Parameters mit einer Schrittweite, die vom Bediener persönlich eingestellt werden kann.

Minimum	Maximal	Standard
1	lmax	1

602 Externer Parameter CH1, CH2, CH3, CH4
 Ermöglicht das Verwalten externer Parameter 1, 2, 3, 4 (Minimalwert, Maximalwert, Standardwert, gewählter Parameter).
 Siehe Abschnitt "Verwaltung Externer Steuerungen (Set up 602)".

705 Kalibrierung des Schweißkreiswiderstands
 Ermöglicht die Einstellung der Anlage.
 Siehe Abschnitt "Kalibrierung des Schweißkreiswiderstands (set up 705)".

751 Stromanzeige
 Ermöglicht die Anzeige des Ist-Schweißstroms.

752 Spannungsanzeige
 Ermöglicht die Anzeige der Ist-Schweißspannung.

768 Messung Wärmeeintrag HI
 Ermöglicht das Ablesen des Wertes der Messung des Wärmeeintrags beim Schweißen.

5.1.2 Liste der Setup-Parameter (WIG-Schweißen)

0 Speichern und Beenden
 Für das Speichern der Änderungen und Verlassen des Setup.

1 Reset
 Für die Rücksetzung aller Parameter auf die Standardwerte.

7 Schweißstrom
 Ermöglicht die Einstellung des Schweißstroms.

Minimum	Maximal	Standard
3 A	lmax	100 A

399 Schweißgeschwindigkeit
 Ermöglicht die Einstellung der Ausführungsgeschwindigkeit der Schweißarbeit.
 Default cm/min: Bezugsgeschwindigkeit für manuelles Schweißen.
 Syn: Sinergic Wert.

Minimum	Maximal	Standard
1 cm/min	200 cm/min	10 cm/min

500 Maschineneinstellung



Ermöglicht die Auswahl der erforderlichen Grafikschnittstelle.
Ermöglicht den Zugang zu höheren Setup Levels.
Siehe Abschnitt "Interface-Personalisierung (Set up 500)"

Wert	Benutzeroberfläche
XE	Modus Easy
XA	Modus Advanced
XP	Modus Professional

Wert	Ausgewählte Ebene
USER	Bediener
SERV	Service
vaBW	vaBW

551 Lock/unlock



Ermöglicht das Sperren der Bedienfelder und die Einführung eines Schutzcodes.
Siehe Abschnitt "Lock/unlock (Set up 551)".

552 Lautstärke der akustischen Warnvorrichtung



Zur Einstellung der Lautstärke der akustischen Warnvorrichtung.

Minimum	Maximal	Standard
0/aus	10	10

601 Schrittweite



Ermöglicht die Regulierung eines Parameters mit einer Schrittweite, die vom Bediener persönlich eingestellt werden kann.

Minimum	Maximal	Standard
1	Imax	1

602 Externer Parameter CH1, CH2, CH3, CH4



Ermöglicht das Verwalten externer Parameter 1, 2, 3, 4 (Minimalwert, Maximalwert, Standardwert, gewählter Parameter).
Siehe Abschnitt "Verwaltung Externer Steuerungen (Set up 602)".

705 Kalibrierung des Schweißkreiswiderstands



Ermöglicht die Einstellung der Anlage.
Siehe Abschnitt "Kalibrierung des Schweißkreiswiderstands (set up 705)".

751 Stromanzeige



Ermöglicht die Anzeige des Ist-Schweißstroms.

752 Spannungsanzeige



Ermöglicht die Anzeige der Ist-Schweißspannung.

755 Gasdurchfluss-Anzeige (WFR)



Ermöglicht die Anzeige des Gasdurchfluss-Istwertes.

757 Anzeige der Drahtgeschwindigkeit



Encoder-Anzeige Motor 1.

760 Stromanzeige (Motor 1)



Ermöglicht die Anzeige des Ist-Motorstroms (Motor 1).

764 Anzeige des Kühlmitteldurchflusses



Ermöglicht die Anzeige des Kühlmitteldurchflusses.

765 Anzeige der Kühlmitteltemperatur
Ermöglicht die Anzeige des Kühlmitteltemperatur.



768 Messung Wärmeeintrag HI
Ermöglicht das Ablesen des Wertes der Messung des Wärmeeintrags beim Schweißen.



801 Schutzgrenzen
Ermöglicht die Einstellung der Warn- und Schutzgrenzen.
Ermöglicht die Steuerung des Schweißverfahrens, indem Warn- und Schutzgrenzen für die messbaren Hauptparameter eingestellt werden.
Ermöglicht die genaue Steuerung der verschiedenen Schweißphasen.
Siehe Abschnitt "Schutzgrenzen (Set up 801)".



5.1.3 Liste der Setup-Parameter (MIG/MAG-Schweißen)

0 Speichern und Beenden
Für das Speichern der Änderungen und Verlassen des Setup.



1 Reset
Für die Rücksetzung aller Parameter auf die Standardwerte.



2 Synergie
MIG/MAG-Standard-Schweißen:
Ermöglicht die Wahl zwischen manuellem (Off) MIG- oder synergischem (6) MIG-Prozess, indem das zu schweißende Material eingestellt wird.
MIG/MAG-Impuls-Schweißen:
Ermöglicht die Wahl synergischem (6) MIG-Prozess, indem das zu schweißende Material eingestellt wird.
Ermöglicht die Wahl CC/CV-Prozess.



3 Drahtvorschubgeschwindigkeit
Ermöglicht die Einstellung der Drahtvorschubgeschwindigkeit.

Minimum	Maximal	Standard
0.5 m/min	22.0 m/min	-



4 Strom
Ermöglicht die Einstellung des Schweißstroms.

Minimum	Maximal
3 A	I _{max}



5 Werkstückdicke
Ermöglicht die Einstellung der Materialdicke des Werkstückes.
Ermöglicht die Einstellung der Anlage durch die die Einstellung des Werkstückes.



6 Kehlnaht "a"
Ermöglicht die Einstellung der Tiefe der Naht in einer Winkelverbindung.



7 Spannung - Bogenlänge



Ermöglicht die Einstellung der Bogenspannung.
 Ermöglicht die Einstellung der Bogenlänge während des Schweißens.
 Hohe Spannung = langer Bogen
 Niedrige Spannung = kurzer Bogen

Manuelles Schweißen

Minimum	Maximal	Standard
5.0 V	55.5 V	5.0 V

10 Gasvorströmen



Für die Einstellung und Regelung des Gasflusses vor der Bogenzündung.
 Für das Laden des Gases in den Brenner und die Vorbereitung der Umgebung auf das Schweißen.

Minimum	Maximal	Standard
0/aus	99.9 s	0.1 s

11 Soft start



Zur Einstellung der Drahtvorschubgeschwindigkeit in den Phasen, die der Zündung des Lichtbogens vorausgehen.
 Ermöglicht eine Zündung bei reduzierter Geschwindigkeit, die daher weicher und mit weniger Spritzern erfolgt.

Minimum	Maximal	Standard
10 %	100 %	50 %

12 Motorrampe



Für die Einstellung eines allmählichen Übergangs von der Drahtgeschwindigkeit bei der Zündung auf jene beim Schweißen.

Minimum	Maximal	Standard
0/aus	1.0 s	0/aus

15 Burn back



Für die Regelung der Drahtrückbrennzeit und zur Verhinderung des Anklebens bei Schweißende.
 Ermöglicht die Einstellung der Länge des Drahtendes außerhalb des Brenners.

Minimum	Maximal	Standard
-2.00	+2.00	0/syn

16 Gasnachströmen



Für die Einstellung des Gasflusses bei Schweißende.

Minimum	Maximal	Standard
0/aus	99.9 s	2.0 s

19 Duty cycle (Doppelimpuls)



Ermöglicht die Einstellung der Einschaltdauer beim Doppelimpuls-Schweißen.

Minimum	Maximal	Standard
10 %	90 %	50 %

20 Doppel-Impuls



Ermöglicht die Einstellung der Impulsamplitude.

Minimum	Maximal	Standard
0 %	100 %	±25 %

Minimum	Maximal	Standard
0.5 m/min	22 m/min	2.5 m/min

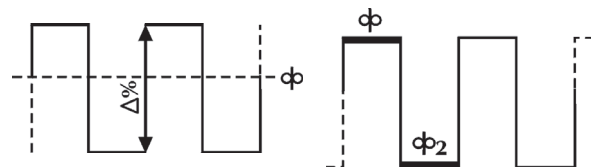

21 Impulszeit (Doppelimpuls)



Ermöglicht die Einstellung des Zyklus, z. B. des Impulswiederholungszyklus.
 Ermöglicht die Regulierung der Impulsfrequenz.

Minimum	Maximal	Standard
0.1 Hz	5.0 Hz	2.0 Hz

22 Sekundärspannung (Doppelimpuls)



Ermöglicht die Einstellung der Höhe der Impuls-Sekundärspannung.
Ermöglicht das Erreichen einer größeren Bogenstabilität während der verschiedenen Impulsphasen.

Minimum	Maximal	Standard
-5.0	+5.0	0/syn

23 Impulssteilheit (Doppelimpuls)



Ermöglicht die Einstellung einer Rampen-Zeit während des Impulsbetriebs.

Minimum	Maximal	Standard
1 %	100 %	50 %

24 Bilevel (4T - crater filler)



Für die Einstellung des Sekundärdrahtgeschwindigkeit in der Schweißmethode Bilevel.

Wenn der Schweißer den Knopf drückt und ihn schnell losläßt, geht man zum zweiten Schweißstrom "ϕ₂" über.

Drücken und schnelles Loslassen des Knopfes geht man wieder auf "ϕ" usw. über.

Minimum	Maximal	Standard
1 %	200 %	0/aus

25 Drahteinschleichen



Ermöglicht die Einstellung des Wertes der Drahtgeschwindigkeit während der Anfangs- Krater-Phase.

Ermöglicht das Ansteigen der dem Werkstück zugeführten Energie während der Phase, in der das Material (noch kalt) mehr Wärme benötigt, um gleichmäßig zu schmelzen.

Minimum	Maximal	Standard
20 %	200 %	120 %

26 Crater filler



Ermöglicht die Einstellung des Wertes der Drahtgeschwindigkeit während der Endkrater-Phase.

Ermöglicht das Absinken der dem Werkstück zugeführten Energie während der Phase, in der das Material bereits sehr heiß ist. So wird das Risiko von ungewollten Deformationen verringert.

Minimum	Maximal	Standard
20 %	200 %	80 %

27 Takten der Anfangsanstiegs



Ermöglicht die Einstellung der Zeit des Anfangsanstiegs.

Ermöglicht die Automatisierung der Funktion "Endkraterfüller".

Minimum	Maximal	Standard
0.1 s	99.9 s	0/aus

28 Takten des Endkraterfüllers



Ermöglicht die Einstellung der Zeit des "Endkraterfüllers".

Ermöglicht die Automatisierung der Funktion "Endkraterfüller".

Minimum	Maximal	Standard
0.1 s	99.9 s	0/aus

30 Punktschweißen

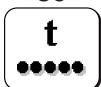

Für die Aktivierung des Punktschweißens und die Festlegung der Schweißzeit.

Minimum	Maximal	Standard
0.1 s	99.9 s	0/aus

31 Pausenzeit



Für die Aktivierung und das Festlegen der Pausenzeit zwischen einem Schweißvorgang und dem nächsten.

Minimum	Maximal	Standard
0.1 s	99.9 s	0/aus

DE

32 Sekundärspannung (MIG-Bilevel)

Ermöglicht die Einstellung der Höhe der Impuls-Sekundärspannung.
Ermöglicht das Erreichen einer größeren Bogenstabilität während der verschiedenen Impulsphasen.

Minimum	Maximal	Standard
-5.0	+5.0	0/syn

33 Sekundärinduktivität (MIG-Bilevel)

Ermöglicht die Einstellung der Höhe der Impuls-Sekundärinduktivität.
Ermöglicht das Erreichen eines schnelleren oder langsameren Bogens, um die Bewegung des Schweißers und die natürliche Schweißinstabilität zu kompensieren.
Niedrige Induktivität = reaktionsfähiger Bogen (mehr Spritzer).
Hohe Induktivität = reaktionsträger Bogen (weniger Spritzer).

Minimum	Maximal	Standard
-30	+30	0/syn

34 Drahteinschleichrampe

Für die Eingabe eines stufenweisen Übergangs vom Drahteinschleichen auf das Schweißen.

Minimum	Maximal	Standard
0 s	10 s	0/aus

35 Endkraterfüller-Rampe

Für die Eingabe eines stufenweisen Übergangs zwischen Schweißen und Endkraterfüller.

Minimum	Maximal	Standard
0 s	10 s	0/aus

202 Induktivität

Ermöglicht die elektronische Einstellung der dem Schweißkreis in Reihe geschalteten Induktivität.
Ermöglicht das Erreichen eines schnelleren oder langsameren Bogens, um die Bewegung des Schweißers und die natürliche Schweißinstabilität zu kompensieren.
Niedrige Induktivität = reaktionsfähiger Bogen (mehr Spritzer).
Hohe Induktivität = reaktionsträger Bogen (weniger Spritzer).

Minimum	Maximal	Standard
-30	+30	0/syn

331 Kompensierte durchschnittliche Spannung

Ermöglicht die Einstellung der Schweißspannung.

399 Schweißgeschwindigkeit

Ermöglicht die Einstellung der Ausführungsgeschwindigkeit der Schweißarbeit.
Default cm/min: Bezugsgeschwindigkeit für manuelles Schweißen.
Syn: Sinergic Wert.

Minimum	Maximal	Standard
syn min	syn max	35 cm/min

500 Maschineneinstellung

Ermöglicht die Auswahl der erforderlichen Grafikschnittstelle.
Ermöglicht den Zugang zu höheren Setup Levels.
Siehe Abschnitt "Interface-Personalisierung (Set up 500)"

Wert	Benutzeroberfläche	Wert	Ausgewählte Ebene
XE	Modus Easy	USER	Bediener
XA	Modus Advanced	SERV	Service
XP	Modus Professional	vaBW	vaBW

551 Lock/unlock

Ermöglicht das Sperren der Bedienfelder und die Einführung eines Schutzcodes.
Siehe Abschnitt "Lock/unlock (Set up 551)".

552 Lautstärke der akustischen Warnvorrichtung



Zur Einstellung der Lautstärke der akustischen Warnvorrichtung.

Minimum	Maximal	Standard
0/aus	10	10

601 Schrittweite



Ermöglicht die Regulierung eines Parameters mit einer Schrittweite, die vom Bediener persönlich eingestellt werden kann.

Funktion über Taste Up/Down des Brenners steuerbar.

Minimum	Maximal	Standard
1	lmax	1

602 Externer Parameter CH1, CH2, CH3, CH4



Ermöglicht das Verwalten externer Parameter 1, 2, 3, 4 (Minimalwert, Maximalwert, Standardwert, gewählter Parameter).

Siehe Abschnitt "Verwaltung Externer Steuerungen (Set up 602)".

606 U/D Brenner



Ermöglicht das Verwalten externer Parameter (U/D).

Wert	Standard	Rückruffunktion
0/aus	-	aus
1/11	X	Strom
	-	Programmabruf

705 Kalibrierung des Schweißkreiswiderstands



Ermöglicht die Einstellung der Anlage.

Siehe Abschnitt "Kalibrierung des Schweißkreiswiderstands (set up 705)".

751 Stromanzeige



Ermöglicht die Anzeige des Ist-Schweißstroms.

752 Spannungsanzeige



Ermöglicht die Anzeige der Ist-Schweißspannung.

755 Gasdurchfluss-Anzeige (WFR)



Ermöglicht die Anzeige des Gasdurchfluss-Istwertes.

757 Anzeige der Drahtgeschwindigkeit



Encoder-Anzeige Motor 1.

758 Geschwindigkeit der Roboterbewegung



Ermöglicht die Anzeige der Geschwindigkeit des Roboterarms oder der automatischen Anlage.

760 Stromanzeige (Motor 1)



Ermöglicht die Anzeige des Ist-Motorstroms (Motor 1).

761 Anzeige der Drahtgeschwindigkeit



Encoder-Anzeige Motor 2.

DE

762 Stromanzeige (Motor 2)
 Ermöglicht die Anzeige des Ist-Motorstroms (Motor 2).



763 Anzeige der Drahtgeschwindigkeit
 Anzeige des Ist-Drahtvorschubs.



764 Anzeige des Kühlmitteldurchflusses
 Ermöglicht die Anzeige des Kühlmitteldurchflusses.



765 Anzeige der Kühlmitteltemperatur
 Ermöglicht die Anzeige des Kühlmitteltemperatur.



768 Messung Wärmeeintrag HI
 Ermöglicht das Ablesen des Wertes der Messung des Wärmeeintrags beim Schweißen.



801 Schutzgrenzen
 Ermöglicht die Einstellung der Warn- und Schutzgrenzen.
 Ermöglicht die Steuerung des Schweißverfahrens, indem Warn- und Schutzgrenzen für die messbaren Hauptparameter eingestellt werden.
 Ermöglicht die genaue Steuerung der verschiedenen Schweißphasen.
 Siehe Abschnitt "Schutzgrenzen (Set up 801)".





5.2 Spezielle Verfahren zur Verwendung der Parameter

5.2.1 Personalisierung der 7-Segment-Anzeige

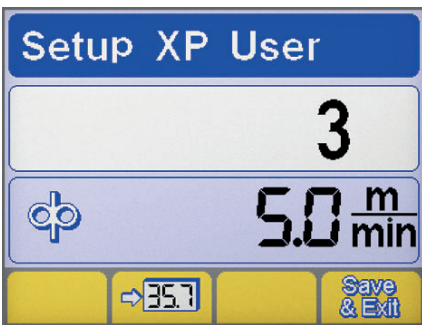
Ermöglicht die konstante Anzeige eines Parameterwerts auf dem Display mit 7 Segmenten.



- ▶ Gehen Sie ins Set-up hinein, indem Sie den Taster Encoder für mindestens 5 Sekunden drücken.
- ▶ Wählen Sie den gewünschten Parameter, indem Sie den Encoder drehen.
- ▶ Speichern Sie den gewählten Parameter in der 7-Segment-Anzeige, indem Sie die Taste drücken .
- ▶ Speichern und verlassen Sie das aktuelle Menü, indem Sie die Taste drücken .

5.2.2 Interface-Personalisierung (Set up 500)

Ermöglicht das Anpassen der Parameter im Haupt-Menü.

500 Maschineneinstellung
 Ermöglicht die Auswahl der erforderlichen Grafikschnittstelle.



Wert	Benutzeroberfläche
XE	Modus Easy
XA	Modus Advanced
XP	Modus Professional

MODUS XE



MMA

Schweißparameter



DE

WIG

Schweißparameter

Funktionen

MIG/MAG

Schweißparameter

Funktionen

MODUS XA

MMA

Schweißparameter

Funktionen

WIG

Schweißparameter

Funktionen

MIG/MAG

Schweißparameter

Funktionen

MODUS XP

MMA

Schweißparameter

Funktionen

WIG

Schweißparameter

Funktionen

MIG/MAG

Schweißparameter

Funktionen

5.2.3 Lock/unlock (Set up 551)

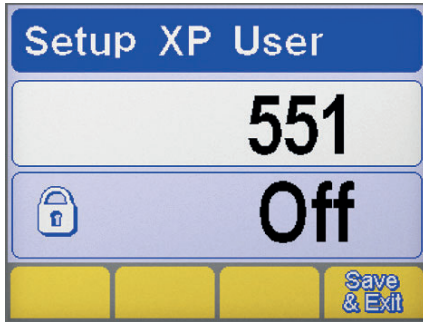

Ermöglicht das Sperren der Bedienfelder und die Einführung eines Schutzcodes.

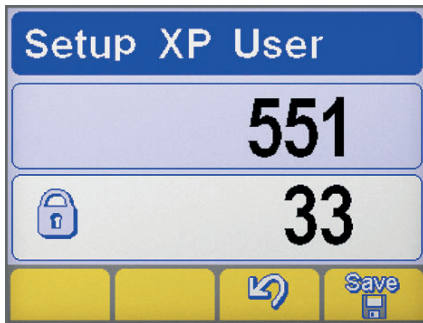

Parameterauswahl

- ▶ Gehen Sie ins Set-up hinein, indem Sie den Taster Encoder für mindestens 5 Sekunden drücken.
- ▶ Wählen Sie den gewünschten Parameter aus (551).
- ▶ Aktivieren Sie die Einstellung des gewählten Parameters, indem Sie den Taster Encoder drücken.





- ▶ Stellen Sie einen Nummerncode (Passwort) ein, indem Sie den Encoder drehen.
- ▶ Den Vorgang durch Drücken der Encoder-Taste bestätigen.
- ▶ Brechen Sie den Vorgang ab, indem Sie die Taste drücken .
- ▶ Zum Speichern der Änderungen folgende Taste drücken: .

Bedienfeldfunktionen

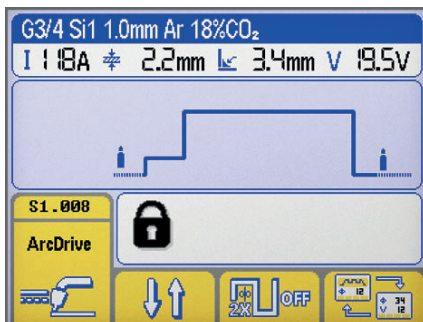

Jedes Ausführen eines Vorganges an einem gesperrten Bedienfeld ruft diese Anzeige hervor.



- ▶ Entsperren Sie das Bedienfeld zeitweise (für 5 Minuten), indem Sie den Encoder drehen und das richtige Passwort eingeben.
- ▶ Den Vorgang durch Drücken der Encoder-Taste bestätigen.
- ▶ Entsperren Sie das Bedienfeld dauerhaft, indem Sie ins Set-up hineingehen (Befolgen Sie die oben gemachten Anweisungen!) und setzen Sie den Parameter 551 zurück auf "OFF".
- ▶ Den Vorgang durch Drücken der Encoder-Taste bestätigen.
- ▶ Zum Speichern der Änderungen folgende Taste drücken: .

5.2.4 Verwaltung Externer Steuerungen (Set up 602)

Ermöglicht das Verwalten externer Parameter 2 (Minimalwert, Maximalwert, Standardwert, gewählter Parameter).

Parameterauswahl

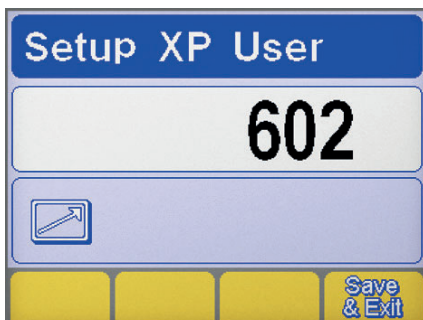

- ▶ Gehen Sie ins Set-up hinein, indem Sie den Taster Encoder für mindestens 5 Sekunden drücken.
- ▶ Wählen Sie den gewünschten Parameter aus (602).
- ▶ Gehen Sie ins Menü "Verwaltung Externer Steuerungen" hinein, indem Sie den Taster Encoder drücken.

Verwaltung Externer Steuerungen

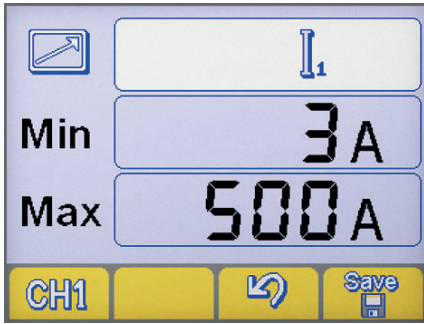

- ▶ Wählen Sie den gewünschten Ausgang der RC Fernsteuerung (CH1, CH2, CH3, CH4), indem Sie die Taste drücken
- ▶ Wählen Sie den gewünschten Parameter (Min-Max-parameter), indem Sie den Taster Encoder drücken.
- ▶ Stellen Sie den gewünschten Parameter (Min-Max-parameter) ein, indem Sie den Encoder drehen.
- ▶ Zum Speichern der Änderungen folgende Taste drücken:
- ▶ Brechen Sie den Vorgang ab, indem Sie die Taste drücken

DE

5.2.5 Kalibrierung des Schweißkreiswiderstands (set up 705)

Ermöglicht die Einstellung des Generators auf den aktuellen Widerstand des Schweißwiderstands.

Parameterauswahl

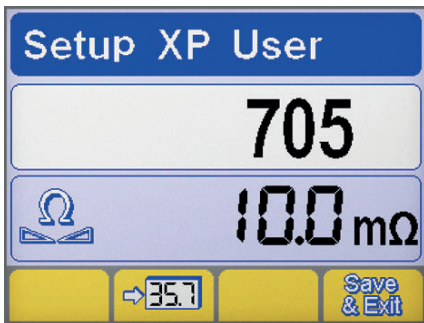

- ▶ Gehen Sie ins Set-up hinein, indem Sie den Taster Encoder für mindestens 5 Sekunden drücken.
- ▶ Wählen Sie den gewünschten Parameter aus (705).
- ▶ Aktivieren Sie die Einstellung des gewählten Parameters, indem Sie den Taster Encoder drücken.
- ▶ Den Generator an den Schweißkreislauf anschließen (Werkbank oder Werkstück).
- ▶ Die Kappe abnehmen und die angegebene Düsenspitze des Brenners einsetzen. (MIG/MAG)

Kalibrierung

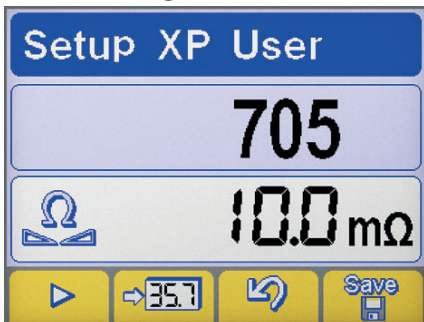

- ▶ Elektrischen Kontakt zwischen Drahtführungsspitze und Schweißwerkstück herstellen. (MIG/MAG)
- ▶ Taste zum Starten des Vorgangs drücken.
- ▶ Die Berührung muss mindestens eine Sekunde lang bestehen.
- ▶ Der am Display gezeigte Wert wird nach der Einstellung aktualisiert.
- ▶ Bestätigen Sie den Vorgang, indem Sie die Taste drücken
- ▶ Brechen Sie den Vorgang ab, indem Sie die Taste drücken
- ▶ Zum Speichern der Änderungen und Verlassen des Setups folgende Taste drücken:

5.2.6 Schutzgrenzen (Set up 801)

Ermöglicht die Einstellung der Warn- und Schutzgrenzen.

Ermöglicht die Steuerung des Schweißverfahrens, indem Warn- und Schutzgrenzen für die messbaren Hauptparameter eingestellt werden.

Ermöglicht die genaue Steuerung der verschiedenen Schweißphasen.

Warngrenzen		⚠ MIN	⚠ MAX	Schutzgrenzen		⚠ MIN	⚠ MAX
	Schweißstrom				Schweißspannung		
	Gasdurchfluss-Anzeige				Geschwindigkeit der Roboterbewegung		
	Stromanzeige (Motor 1)				Stromanzeige (Motor 2)		
	Anzeige des Kühlmitteldurchflusses				Anzeige der Drahtgeschwindigkeit		
	Anzeige der Kühlmitteltemperatur						

Parameterauswahl

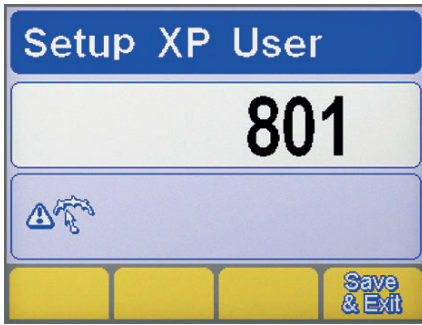

- ▶ Gehen Sie ins Set-up hinein, indem Sie den Taster Encoder für mindestens 5 Sekunden drücken.
- ▶ Wählen Sie den gewünschten Parameter aus (801).
- ▶ Gehen Sie ins Menü "Schutzgrenzen" hinein, indem Sie den Taster Encoder drücken.

Parameterauswahl

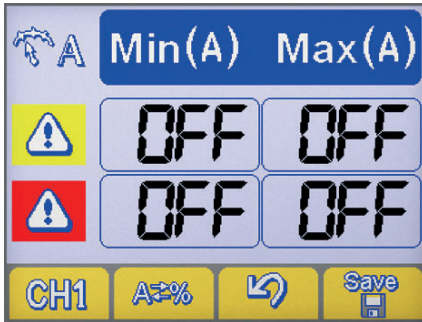

- ▶ Wählen Sie den gewünschten Parameter, indem Sie die Taste drücken **CH1**.
- ▶ Wählen Sie die Einstellungsmethode der Schutzgrenzen, indem Sie die Taste drücken. **A=%**.

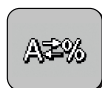

Modusauswahl



Absoluter Wert



Prozentwert

Einstellung der Schutzgrenzen

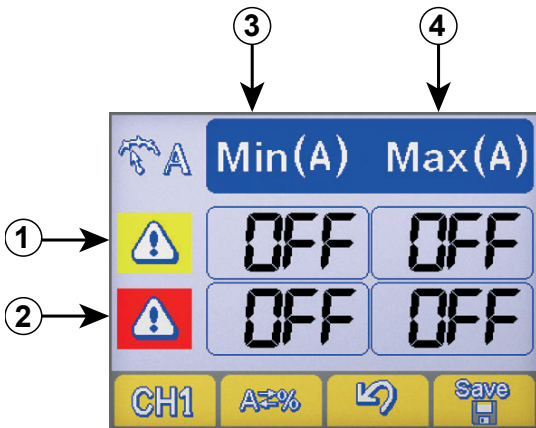

- ① Zeile Warngrenzen
- ② Zeile Alarmgrenzen
- ③ Spalte Minimalgrenze
- ④ Spalte Maximalgrenze

- ▶ Wählen Sie den gewünschten Kasten, indem Sie den Taster Encoder drücken (der ausgewählte Kasten wird invers dargestellt).
- ▶ Stellen Sie den Wert der gewählten Grenze ein, indem Sie den Encoder drehen.
- ▶ Zum Speichern der Änderungen folgende Taste drücken: **Save**.



Das Überschreiten einer der Schutzgrenzen lässt ein sichtbares Signal auf dem Bedienfeld erscheinen.





Das Überschreiten einer der Alarmgrenzen lässt ein sichtbares Signal auf dem Bedienfeld erscheinen und löst die sofortige Blockade des Schweißvorgangs aus.



Es ist möglich Anfangs- und Endfilter für das Schweißen einzustellen, um Fehlermeldungen während des Zündens und Erlöschens des Lichtbogens vorzubeugen (siehe Abschnitt "Set-up" - Parameter 802-803-804).

DE

6. WARTUNG



-  Die regelmäßige Wartung der Anlage muss nach den Angaben des Herstellers erfolgen. Wenn das Gerät in Betrieb ist, müssen alle Zugangs-, Wartungstüren und Abdeckungen geschlossen und verriegelt sein. Die Anlage darf keiner Änderung unterzogen werden. Vermeiden Sie Ansammlungen von Metallstaub in der Nähe und über den Lüftungsschlitzen.
-  Jeder Wartungseingriff darf nur von Fachpersonal ausgeführt werden. Das Reparieren oder Austauschen von Anlageteilen durch unautorisiertes Personal hebt die Produktgarantie auf. Das Reparieren oder Austauschen von Anlageteilen darf ausschließlich von Fachpersonal ausgeführt werden.
-  Trennen Sie die Anlage von der Stromzufuhr vor jedem Wartungseingriff!

6.1 Führen Sie folgende regelmäßige Überprüfungen am Generator durch

6.1.1 Anlage

-  Das Innere der Anlage mittels Druckluft mit niederem Druck und weichen Pinseln reinigen. Elektrische Verbindungen und Anschlusskabel prüfen.



6.1.2 Für die Instandhaltung oder das Austauschen von Schweißbrennersbestandteilen, der Schweißzange und/oder der Erdungskabel:

-  Die Temperatur der Teile kontrollieren und sicherstellen, dass sie nicht mehr heiß sind.
-  Immer Schutzhandschuhe anziehen, die den Sicherheitsstandards entsprechen.
-  Geeignete Schlüssel und Werkzeuge verwenden.













6.2 Verantwortung



-  Durch Unterlassung der oben genannten Wartung wird jegliche Garantie aufgehoben und der Hersteller wird von jeglicher Haftung befreit. Der Hersteller übernimmt keinerlei Haftung, falls sich der Benutzer nicht an diese Vorschriften hält. Wenden Sie sich bei jedem Zweifel und/oder bei jedem Problem an die nächstgelegene Technische Kundendienststelle.

7. ALARMCODES

-  **ALARM**
Die Auslösung eines Alarms bzw. das Überschreiten einer kritischen Warnschwelle hat eine entsprechende Anzeige am Bedienfeld sowie den sofortigen Abbruch der Schweißvorgänge zur Folge.
-  **ACHTUNG**
Die Auslösung eines Alarms bzw. das Überschreiten einer kritischen Warnschwelle hat eine entsprechende Anzeige am Bedienfeld sowie den sofortigen Abbruch der Schweißvorgänge zur Folge.

Nachstehend sind alle Alarmer und Warnschwellen der Anlage aufgelistet.

 E01	Übertemperatur		 E02	Übertemperatur	
 E03	Übertemperatur		 E05	Überstrom	
 E06	Überstrom des Leistungsmoduls (Boost)		 E07	Fehler in der Stromversorgung des Drahtvorschubmotors	

 E08 Motor blockiert 	 E10 Überstrom des Leistungsmoduls (Inverter) 
 E11 Anlagen-Konfigurationsfehler 	 E12 Kommunikationsfehler (WF - DSP) 
 E13 Kommunikationsfehler 	 E14 Ungültiges Programm 
 E15 Ungültiges Programm 	 E16 Kommunikationsfehler (RI) (automatisierung und robotik) 
 E17 Kommunikationsfehler (µP-DSP) 	 E18 Ungültiges Programm 
 E19 Anlagen-Konfigurationsfehler 	 E20 Speicher defekt 
 E21 Datenverlust 	 E22 Kommunikationsfehler (DSP) 
 E29 Maße unvereinbar 	 E30 Kommunikationsfehler (H.F.) 
 E32 Datenverlust 	 E38 Unterspannung 
 E39 Stromversorgung der Anlage Fehler 	 E40 Stromversorgung der Anlage Fehler 
 E43 Kühlmittelmangel 	 E48 Drahtmangel (automatisierung und robotik) 
 E49 Notschalter (automatisierung und robotik) 	 E50 Draht festgeklebt (automatisierung und robotik) 
 E51 Einstellungen nicht unterstützt (automatisierung und robotik) 	 E52 Anti-Kollision (automatisierung und robotik) 
 E53 Externer Gasdurchflussmesser Fehler (automatisierung und robotik) 	 E54 Stromgrenze überschritten (Untere Grenze) 
 E55 Stromgrenze überschritten (Obere Grenze) 	 E56 Spannungsgrenze überschritten (Untere Grenze) 
 E57 Spannungsgrenze überschritten (Obere Grenze) 	 E60 Geschwindigkeitsgrenze überschritten (Untere Grenze) 
 E61 Geschwindigkeitsgrenze überschritten (Obere Grenze) 	 E62 Stromgrenze überschritten (Untere Grenze) 

E63	Stromgrenze überschritten (Obere Grenze)	A ↑	E64	Spannungsgrenze überschritten (Untere Grenze)	V ↓
E65	Spannungsgrenze überschritten (Obere Grenze)	V ↑	E68	Geschwindigkeitsgrenze überschritten (Untere Grenze)	
E69	Geschwindigkeitsgrenze überschritten (Obere Grenze)		E70	Schutzgrenzen nicht kompatibel eingestellt	
E71	Übertemperatur des Kühlmittels		E72	Push-Pull-Motorüberstrom	
E73	Drahtgeschwindigkeitsbegrenzung überschritten (speed meter)		E74	Stromgrenze Motor 1 überschritten	A ϕ
E75	Stromgrenze Motor 2 überschritten	A ϕ	E76	Kühlmitteldurchflussgrenze überschritten	
E77	Kühlmitteltemperaturgrenze überschritten		E78	Wartung aktiviert (automatisierung und robotik)	

8. FEHLERSUCHE

Anlage lässt sich nicht einschalten (grüne LED aus)

Ursache

- » Keine Netzspannung an Versorgungssteckdose.
- » Stecker oder Versorgungskabel defekt.
- » Netzsicherung durchgebrannt.
- » Hauptschalter defekt.
- » Fehlerhafte oder defekte Verbindung zwischen Drahtvorschubgerät und Generator.
- » Elektronik defekt.

Lösung

- » Elektrische Anlage überprüfen und ggf. reparieren.
- » Nur Fachpersonal dazu einsetzen.
- » Schadhafte Teil ersetzen.
- » Anlage von der nächstgelegenen Kundendienststelle reparieren lassen.
- » Schadhafte Teil ersetzen.
- » Schadhafte Teil ersetzen.
- » Anlage von der nächstgelegenen Kundendienststelle reparieren lassen.
- » Überprüfen, ob die verschiedenen Teile der Anlage richtig angeschlossen sind.
- » Anlage von der nächstgelegenen Kundendienststelle reparieren lassen.

Keine Ausgangsleistung (Anlage schweißt nicht)

Ursache

- » Brenntaste defekt.
- » Anlage überhitzt (Übertempuralarm - gelbe LED an).
- » Seitliche Abdeckung geöffnet oder Türschalter defekt.
- » Masseverbindung unkorrekt.

Lösung

- » Schadhafte Teil ersetzen.
- » Anlage von der nächstgelegenen Kundendienststelle reparieren lassen.
- » Warten, bis die Anlage abgekühlt ist, die Anlage aber nicht ausschalten.
- » Aus Gründen der Arbeitssicherheit muss die seitliche Abdeckung beim Schweißen geschlossen sein.
- » Schadhafte Teil ersetzen.
- » Anlage von der nächstgelegenen Kundendienststelle reparieren lassen.
- » Korrekte Masseverbindung ausführen.
- » Siehe Kapitel "Inbetriebnahme".

» Netzspannung außerhalb des Bereiches der zulässigen Betriebsspannung (gelbe LED an).

» Netzspannung wieder in den Bereich der zulässigen Betriebsspannung des Generators bringen.
» Korrekten Anschluss der Anlage ausführen.
» Siehe Kapitel "Anschluss".

» Elektronik defekt.

» Anlage von der nächstgelegenen Kundendienststelle reparieren lassen.

Falsche Ausgangsleistung

Ursache

» Falsche Auswahl des Schweißverfahrens oder Wahlschalter defekt.

Lösung

» Korrekte Auswahl des Schweißverfahrens treffen.
» Schadhafte Teil ersetzen.
» Anlage von der nächstgelegenen Kundendienststelle reparieren lassen.

» Falsche Einstellungen der Parameter und der Funktionen der Anlage.

» Ein Reset der Anlage ausführen und die Schweißparameter neu einstellen.

» Potentiometer/Encoder zur Regulierung des Schweißstroms defekt.

» Schadhafte Teil ersetzen.
» Anlage von der nächstgelegenen Kundendienststelle reparieren lassen.

» Netzspannung außerhalb des Bereiches der zulässigen Betriebsspannung.

» Korrekten Anschluss der Anlage ausführen.
» Siehe Kapitel "Anschluss".

» Ausfall einer Phase.

» Korrekten Anschluss der Anlage ausführen.
» Siehe Kapitel "Anschluss".

» Elektronik defekt.

» Anlage von der nächstgelegenen Kundendienststelle reparieren lassen.

Drahtvorschub blockiert

Ursache

» Brennergaste defekt.

Lösung

» Schadhafte Teil ersetzen.
» Anlage von der nächstgelegenen Kundendienststelle reparieren lassen.

» Rollen nicht korrekt oder abgenutzt.

» Rollen ersetzen.

» Getriebemotor defekt.

» Schadhafte Teil ersetzen.
» Anlage von der nächstgelegenen Kundendienststelle reparieren lassen.

» Drahtführungsspirale beschädigt.

» Schadhafte Teil ersetzen.
» Anlage von der nächstgelegenen Kundendienststelle reparieren lassen.

» Drahtvorschub nicht gespeist.

» Anschluss am Generator überprüfen.
» Siehe Kapitel "Anschluss".
» Anlage von der nächstgelegenen Kundendienststelle reparieren lassen.

» Wicklung des Drahtes auf der Spule unregelmäßig.

» Verwicklung des Drahtes beheben oder Spule ersetzen.

» Brennerdüse geschmolzen (Draht klebt)

» Schadhafte Teil ersetzen.

Drahtvorschub unregelmäßig

Ursache

» Brennergaste defekt.

Lösung

» Schadhafte Teil ersetzen.
» Anlage von der nächstgelegenen Kundendienststelle reparieren lassen.

» Rollen nicht korrekt oder abgenutzt.

» Rollen ersetzen.

» Getriebemotor defekt.

» Schadhafte Teil ersetzen.
» Anlage von der nächstgelegenen Kundendienststelle reparieren lassen.

» Drahtführungsspirale beschädigt.

» Schadhafte Teil ersetzen.
» Anlage von der nächstgelegenen Kundendienststelle reparieren lassen.

» Fehleinstellung der Spulenbremse oder der Andruckrollen.

» Spulenbremse lockern.
» Druck auf die Andruckrollen erhöhen.

Unstabiler Lichtbogen

Ursache

- » Schutzgas ungenügend.
- » Feuchtigkeit im Schweißgas.
- » Schweißparameter unkorrekt.

Lösung

- » Druckluftdurchfluss korrekt regulieren.
- » Prüfen, dass Diffusor und Gasdüse am Brenner in gutem Zustand sind.
- » Immer Produkte und Materialien hochwertiger Qualität benutzen.
- » Für den einwandfreien Zustand der Gaszuleitung sorgen.
- » Schweißanlage genau kontrollieren.
- » Anlage von der nächstgelegenen Kundendienststelle reparieren lassen.

Zu viele Spritzer

Ursache

- » Bogenlänge unkorrekt.
- » Schweißparameter unkorrekt.
- » Schutzgas ungenügend.
- » Bogen dynamik unkorrekt.
- » Durchführung des Schweißens unkorrekt.

Lösung

- » Abstand zwischen Elektrode und Werkstück reduzieren.
- » Schweißspannung verringern.
- » Schweißstrom verringern.
- » Druckluftdurchfluss korrekt regulieren.
- » Prüfen, dass Diffusor und Gasdüse am Brenner in gutem Zustand sind.
- » Induktivitätswert des Schweißkreises erhöhen.
- » Ausgangsbuchse mit größerer Induktivität verwenden.
- » Brennerneigung reduzieren.

Ungenügende Durchstrahlungsdicke

Ursache

- » Durchführung des Schweißens unkorrekt.
- » Schweißparameter unkorrekt.
- » Elektrode unkorrekt.
- » Nahtvorbereitung unkorrekt.
- » Masseverbindung unkorrekt.
- » Zu große Werkstücke.

Lösung

- » Vorschubgeschwindigkeit beim Schweißen herabsetzen.
- » Schweißstrom erhöhen.
- » Eine Elektrode mit kleinerem Durchmesser benutzen.
- » Abschrägung vergrößern.
- » Korrekte Masseverbindung ausführen.
- » Siehe Kapitel "Inbetriebnahme".
- » Schweißstrom erhöhen.

Zundereinschlüsse

Ursache

- » Unvollständiges Entfernen des Zunders.
- » Elektrode mit zu großem Durchmesser.
- » Nahtvorbereitung unkorrekt.
- » Durchführung des Schweißens unkorrekt.

Lösung

- » Werkstücke vor dem Schweißen sorgfältig reinigen.
- » Eine Elektrode mit kleinerem Durchmesser benutzen.
- » Abschrägung vergrößern.
- » Abstand zwischen Elektrode und Werkstück reduzieren.
- » In allen Schweißphasen ordnungsgemäß vorgehen.

Wolfram-Einschlüsse

Ursache

- » Schweißparameter unkorrekt.
- » Elektrode unkorrekt.
- » Durchführung des Schweißens unkorrekt.

Lösung

- » Schweißstrom verringern.
- » Elektrode mit größerem Durchmesser benutzen.
- » Immer Produkte und Materialien hochwertiger Qualität benutzen.
- » Elektrode korrekt schleifen.
- » Kontakte zwischen Elektrode und Schweißbad vermeiden.

Blasen

Ursache

- » Schutzgas ungenügend.

Lösung

- » Druckluftdurchfluss korrekt regulieren.
- » Prüfen, dass Diffusor und Gasdüse am Brenner in gutem Zustand sind.

Verklebungen

Ursache	Lösung
» Bogenlänge unkorrekt.	» Abstand zwischen Elektrode und Werkstück vergrößern. » Schweißspannung erhöhen.
» Schweißparameter unkorrekt.	» Schweißstrom erhöhen. » Schweißspannung erhöhen.
» Durchführung des Schweißens unkorrekt.	» Brennerneigung erhöhen.
» Zu große Werkstücke.	» Schweißstrom erhöhen.
» Bogendynamik unkorrekt.	» Induktivitätswert des Schweißkreises erhöhen. » Ausgangsbuchse mit größerer Induktivität verwenden.

Einschnitte an den Rändern

Ursache	Lösung
» Schweißparameter unkorrekt.	» Schweißstrom verringern. » Eine Elektrode mit kleinerem Durchmesser benutzen.
» Bogenlänge unkorrekt.	» Abstand zwischen Elektrode und Werkstück reduzieren. » Schweißspannung verringern.
» Durchführung des Schweißens unkorrekt.	» Seitliche Pendelgeschwindigkeit beim Füllen reduzieren. » Vorschubgeschwindigkeit beim Schweißen herabsetzen.
» Schutzgas ungenügend.	» Gas verwenden, das für die zu schweißenden Werkstoffe geeignet ist.

Oxydationen

Ursache	Lösung
» Schutzgas ungenügend.	» Druckluftdurchfluss korrekt regulieren. » Prüfen, dass Diffusor und Gasdüse am Brenner in gutem Zustand sind.

Porosität

Ursache	Lösung
» Vorhandensein von Fett, Lack, Rost oder Schmutz auf den Werkstücken.	» Werkstücke vor dem Schweißen sorgfältig reinigen.
» Vorhandensein von Feuchtigkeit im Zusatzwerkstoff.	» Immer Produkte und Materialien hochwertiger Qualität benutzen. » Zusatzwerkstoff immer in einwandfreiem Zustand halten
» Vorhandensein von Feuchtigkeit im Zusatzwerkstoff.	» Immer Produkte und Materialien hochwertiger Qualität benutzen. » Zusatzwerkstoff immer in einwandfreiem Zustand halten
» Bogenlänge unkorrekt.	» Abstand zwischen Elektrode und Werkstück reduzieren. » Schweißspannung verringern.
» Feuchtigkeit im Schweißgas.	» Immer Produkte und Materialien hochwertiger Qualität benutzen. » Für den einwandfreien Zustand der Gaszuleitung sorgen.
» Schutzgas ungenügend.	» Druckluftdurchfluss korrekt regulieren. » Prüfen, dass Diffusor und Gasdüse am Brenner in gutem Zustand sind.
» Zu schnelles Erstarren des Schweißbads.	» Vorschubgeschwindigkeit beim Schweißen herabsetzen. » Werkstücke vorwärmen. » Schweißstrom erhöhen.

Wärmerisse

Ursache	Lösung
» Schweißparameter unkorrekt.	» Schweißstrom verringern. » Eine Elektrode mit kleinerem Durchmesser benutzen.
» Vorhandensein von Fett, Lack, Rost oder Schmutz auf den Werkstücken.	» Werkstücke vor dem Schweißen sorgfältig reinigen.
» Vorhandensein von Feuchtigkeit im Zusatzwerkstoff.	» Immer Produkte und Materialien hochwertiger Qualität benutzen. » Zusatzwerkstoff immer in einwandfreiem Zustand halten

- » Durchführung des Schweißens unkorrekt.
- » Ungleiche Eigenschaften der Werkstücke.
- » Den korrekten Arbeitsablauf für die zu schweißende Verbindung ausführen.
- » Vor dem Schweißen ein Puffern ausführen.

Kälterisse

Ursache

- » Vorhandensein von Feuchtigkeit im Zusatzwerkstoff.
- » Besondere Form der zu schweißenden Verbindung.

Lösung

- » Immer Produkte und Materialien hochwertiger Qualität benutzen.
- » Zusatzwerkstoff immer in einwandfreiem Zustand halten
- » Werkstücke vorwärmen.
- » Ein Nachwärmen ausführen.
- » Den korrekten Arbeitsablauf für die zu schweißende Verbindung ausführen.

DE

9. THEORETISCHE HINWEISE ZUM SCHWEISSEN

9.1 Schweißen mit Mantelelektroden (E-Hand-Schweißen)

Vorbereitung der Schweißkanten

Um gute Schweißergebnisse zu erhalten, ist es in jedem Fall ratsam, an sauberen Teilen zu arbeiten, die frei von Oxidation, Rost oder anderen Schmutzpartikeln sind.

Wahl der Elektrode

Der Durchmesser der Schweißelektrode hängt von der Werkstoffdicke, der Position, dem Nahttyp und von der Vorbereitung des Werkstücks ab. Elektroden mit großem Durchmesser erfordern eine hohe Stromzufuhr woraus eine hohe Wärmezufuhr beim Schweißvorgang resultiert. Durchmesser erfordern eine hohe Stromzufuhr woraus eine hohe Wärmezufuhr beim Schweißvorgang resultiert.

Art der Ummantelung	Eigenschaften	Verwendung
Rutil	Einfachheit in der alle Positionen	Verwendung
Sauer hohe	Schmelzgeschwindigkeit	ebenflächig
Basisch	gute mechanische Eigenschaften	Verwendung

Wahl des Schweißstromes

Der dem Typ der verwendeten Elektrode entsprechende Schweißstrom-Bereich wird von den Elektrodenherstellern auf der Verpackung der Elektroden angegeben.

Zündung und Aufrechterhaltung des Lichtbogens

Der elektrische Lichtbogen wird durch Reibung der Elektrodenspitze am geerdeten Schweißstück und durch rasches Zurückziehen des Stabes bis zum normalen Schweißabstand nach erfolgter Zündung des Lichtbogens hergestellt. In letzterem Fall wird die Befreiung durch einen seitlichen Ruck herbeigeführt.

Um die Bogenzündung zu verbessern, ist es im Allgemeinen von Vorteil, den Strom anfänglich gegenüber dem Grundsweißstrom zu erhöhen (Hot-Start). Nach Herstellung des Lichtbogens beginnt die Schmelzung des Mittelstückes der Elektrode, die sich tropfenförmig auf dem Schweißstück ablagert. Der äußere Mantel der Elektrode wird aufgebraucht und liefert damit das Schutzgas für die Schweißung, die somit eine gute Qualität erreicht. Um zu vermeiden, dass die Tropfen des geschmolzenen Materials, infolge unbeabsichtigten Annäherns der Elektrode an das Schweißbad, einen Kurzschluss hervorrufen und dadurch das Erlöschen des Lichtbogens verursachen, ist es nützlich, den Schweißstrom kurzzeitig, bis zur Beendigung des Kurzschlusses, zu erhöhen Falls die Elektrode am Werkstück kleben bleibt, ist es nützlich, den Kurzschlussstrom auf das Geringste zu reduzieren (Antisticking).

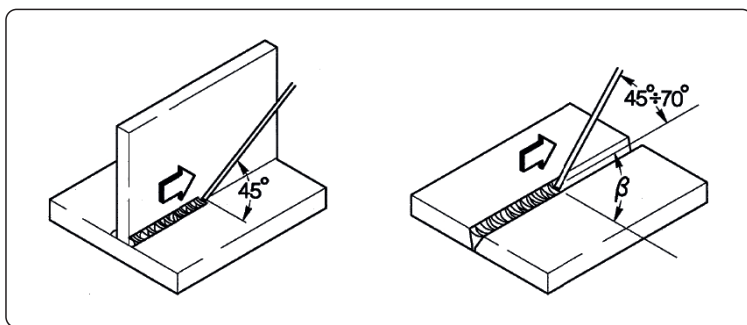

Ausführung der Schweißung

Der Neigewinkel der Elektrode ist je nach der Anzahl der Durchgänge verschieden. Die Bewegung der Elektrode wird normalerweise mit Pendeln und Anhalten an den Seiten der Schweißnaht durchgeführt, wodurch eine übermäßige Ansammlung von Schweißgut in der Mitte vermieden werden soll.

Entfernung der Schlacke

Das Schweißen mit Mantelelektroden erfordert nach jedem Durchgang die Entfernung der Schlacke. Die Entfernung der Schlacke erfolgt mittels eines kleinen Hammers oder bei leicht bröckelnder Schlacke durch Bürsten.

9.2 WIG-Schweißen (kontinuierlicher Lichtbogen)

Beschreibung

Das Prinzip des WIG-Schweißens (Wolfram-Inert-Gas-Schweißen) basiert auf einem elektrischen Lichtbogen, der zwischen einer nichtschmelzenden Elektrode (reines oder legiertes Wolfram mit einer Schmelztemperatur von ungefähr 3370°C) und dem Werkstück gezündet wird. Eine Inertgas-Atmosphäre (Argon) schützt das Schweißbad. Um gefährliche Wolframeinschlüsse in der Schweißnaht zu vermeiden, darf die Elektrode nicht mit dem zu schweißenden Stück in Berührung kommen. Aus diesem Grund wird mittels eines HF-Generators eine Entladung erzeugt, die die Zündung des elektrischen Lichtbogens ermöglicht, ohne dass die Elektrode das Werkstück berührt. Es gibt auch eine weitere Startmöglichkeit mit herabgesetzten Wolframeinschlüssen: der Lift-Start, der keine hohe Frequenz vorsieht, sondern nur eine anfängliche Kurzschlussphase bei Niederstrom zwischen Elektrode und Werkstück. Im Augenblick der Anhebung der Elektrode entsteht der Lichtbogen und die Stromzufuhr erhöht sich bis zur Erreichung des eingestellten Schweißwertes. Um die Qualität des Schweißnahtendes zu verbessern, ist es äußerst vorteilhaft, das Absinken des Schweißstroms genau kontrollieren zu können und es ist notwendig, dass das Gas auch nach dem Ausgehen des Bogens für einige Sekunden in das Schweißbad strömt. Unter vielen Arbeitsbedingungen ist es von Vorteil, über 2 voreingestellte Schweißströme zu verfügen, mit der Möglichkeit, von einem auf den anderen übergehen zu können (BILEVEL).

Schweißpolung

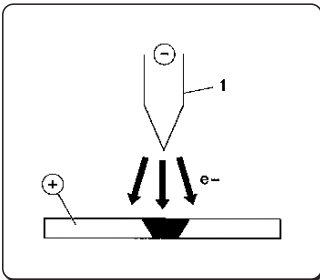

D.C.S.P. (Direct Current Straight Polarity)

Es handelt sich hierbei um die am meisten gebrauchte Polung (direkte Polung); sie bewirkt eine begrenzte Abnutzung der Elektrode (1), da sich 70% der Wärme auf der Anode (Werkstück) ansammelt.

Man erhält ein tiefes und schmales Bad durch hohe Vorschubgeschwindigkeit und daraus resultierender geringer Wärmezufuhr.

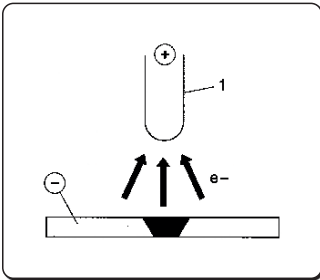

D.C.R.P. (Direct Current Reverse Polarity)

Mit der umgekehrten Polung kann man Legierungen mit einer hitzebeständigen Oxid-Beschichtung, deren wesentliche Eigenschaft eine höhere Schmelztemperatur als jene des Metalls ist, schweißen.

Trotzdem dürfen nicht zu hohe Ströme verwendet werden, da diese eine rasche Abnutzung der Elektrode verursachen würden.

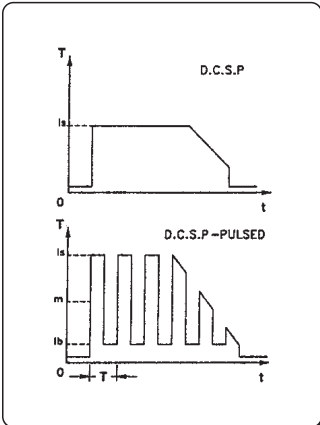

D.C.S.P.-Pulsed (Direct Current Straight Polarity Pulsed)

Die Anwendung eines Pulsstroms erlaubt in besonderen Betriebssituationen eine bessere Kontrolle des Schweißbads in Breite und Tiefe.

Das Schweißbad wird von den Spitzenimpulsen (I_p) gebildet, während der Basisstrom (I_b) den Bogen gezündet hält. Das erleichtert das Schweißen dünner Materialstärken mit geringeren Verformungen, einen besseren Formfaktor und somit eine geringere Gefahr, dass Wärmerisse und gasförmige Einschlüsse auftreten.

Durch Steigern der Frequenz (Mittelfrequenz) erzielt man einen schmalen, konzentrierteren und stabileren Bogen, was einer weiteren Verbesserung der Schweißqualität bei dünnen Materialstärken gleichkommt.

WIG-Schweißen von Stahlmaterial

Das WIG-Verfahren ist für das Schweißen sowohl von WIGlegiertem als auch von Kohlenstoffstahl, für den ersten Schweißgang von Rohren und für Schweißungen, die ein sehr gutes Aussehen haben müssen, besonders geeignet. Direktpolung erforderlich (D.C.S.P.).

Vorbereitung der Schweißkanten

Eine sorgfältige Reinigung und Nahtvorbereitung ist erforderlich.

Wahl und Vorbereitung der Elektrode

Der Gebrauch von Thoriumwolframelektroden (2% Thorium - rote Farbe) oder anstelle dessen von Zerium- oder Lanthanwolframelektroden mit folgenden Durchmessern wird empfohlen:

Ø elektrode	Strombereich
1.0 mm	15÷75 A
1.6 mm	60÷150 A
2.4 mm	130÷240 A

Die Elektrode muss wie in der Abbildung gezeigt zugespitzt werden.

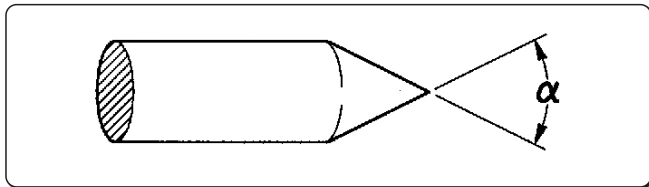

α°	Strombereich
30	0÷30 A
60÷90	30÷120 A
90÷120	120÷250 A

Schweißgut

Die mechanischen Eigenschaften der Schweißstäbe müssen in etwa jenen des Grundmaterials entsprechen.

Aus dem Grundmaterial erhaltene Streifen dürfen nicht verwendet werden, da die von der Verarbeitung herrührenden Unreinheiten die Schweißung wesentlich beeinträchtigen könnten.

Schutzgas

In der Praxis wird fast ausschließlich (99.99 %) reines Argon verwendet.

Schweißstrom	Øelektrode	Gasdüse n°	Gasdüse	Argonfluss
30 A	0÷30 mm	4/5	6/8.0 mm	5-6 l/min
60÷90 A	30÷120 mm	4/5/6	6.5/8.0/9.5 mm	6-7 l/min
90÷120 A	120÷250 mm	6/7	9.5/11.0 mm	7-8 l/min

WIG-Schweißen von Kupfer

Da es sich beim WIG-Schweißen um ein Verfahren mit einer hohen Wärmekonzentration handelt, eignet es sich besonders für das Schweißen von Material mit hoher Wärmeleitfähigkeit, wie z. B. Kupfer.

Für das WIG-Schweißen von Kupfer die gleichen Anweisungen wie für das WIG-Schweißen von Stahl bzw. spezielle Anweisungen befolgen.

9.3 Schweißen mit Endlosdrahtelektroden (MIG/MAG)

Einleitung

Ein MIG-System besteht aus einem Gleichstromgenerator, einer Vorrichtung für die Drahtzuführung, einer Drahtspule und einem Gasbrenner.

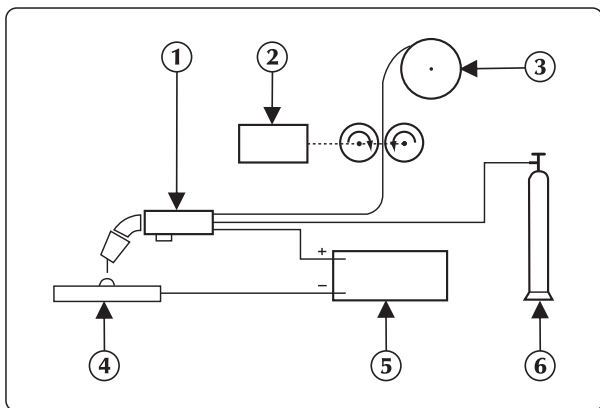

Manuelle Schweißanlage

Der Strom wird über die Schmelzelektrode (Draht mit positiver Polung) zum Bogen übertragen;

Bei diesem Verfahren wird das geschmolzene Metall durch den Bogen auf das Werkstück übertragen.

Die Drahtzuführung ist erforderlich, um den beim Schweißen geschmolzenen Elektrodendraht wieder zu ergänzen.

Verfahren

Beim Schweißen unter Schutzgas gibt es zwei Übertragungsmethoden, die sich dadurch unterscheiden, wie sich die Tropfen von der Elektrode ablösen.

Bei der ersten Methode, "KURZSCHLUSSÜBERTRAGUNG (SHORT-ARC)" genannt, tritt die Elektrode in direkten Kontakt mit dem Bad, dann wird ein Kurzschluss mit Schmelzwirkung des Drahts verursacht, der deswegen unterbrochen wird. Danach zündet der Bogen wieder und der Zyklus wiederholt sich.

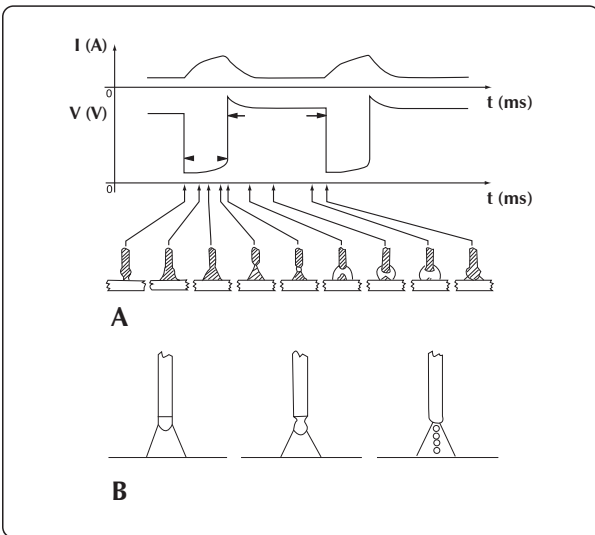

SHORT-ARC-Zyklus und SPRAY-ARC-Schweißung

Die zweite Methode für die Übertragung der Tropfen ist die sogenannte "SPRITZERÜBERTRAGUNG (SPRAY-ARC)", wobei sich die Tropfen von der Elektrode ablösen und erst danach das Schmelzbad erreichen.

Schweißparameter

Die Sichtbarkeit des Bogens verringert die Notwendigkeit einer genauesten Beachtung der Einstelltabellen durch den Schweißer, da er die Möglichkeit hat, das Schmelzbad direkt zu kontrollieren.

- Die Spannung hat einen direkten Einfluss auf das Aussehen der Schweißnaht, aber die Abmessungen der geschweißten Oberfläche können je nach Bedarf variiert werden, indem die Brennerbewegung von Hand getätigt wird, so dass man verschiedenartige Ablagerungen bei konstanter Spannung erhält.
- Die Drahtvorschubgeschwindigkeit ist proportional zum Schweißstrom.

In folgenden zwei Abbildungen werden die Beziehungen zwischen den verschiedenen Schweißparametern veranschaulicht.







Tabelle zur wahl der schweissparameter mit bezug auf die typischsten anwendungen und die am häufigsten benutzten schweisdrähte

Bogenspannung	Ø 0,8 mm	Ø 1,0-1,2 mm	Ø 1,6 mm	Ø 2,4 mm
16V - 22V SHORT - ARC				
	60 - 160 A Geringe Durchdringung bei dünnem Material	100 - 175 A Gute Kontrolle der Durchdringung und der Schmelzung	120 - 180 A Gute horizontale und vertikale Schmelzung	150 - 200 A Nicht verwendet
				
	150 - 250 A Automatisches Kehlnahtschweißen	200 - 300 A Automatisches Hochspannungsschweißen	250 - 350 A Automatisches Abwärtsschweißen	300 - 400 A Nicht verwendet
30V - 45V SPRAY - ARC				
	150 - 250 A Geringe Durchdringung mit Einstellung auf 200 A	200 - 350 A Automatisches Schweißen mit mehreren Schweißlagen	300 - 500 A Gute Durchdringung beim Abwärtsschweißen	500 - 750 A Gute Durchdringung und hohe Ablagerung auf dickem Material

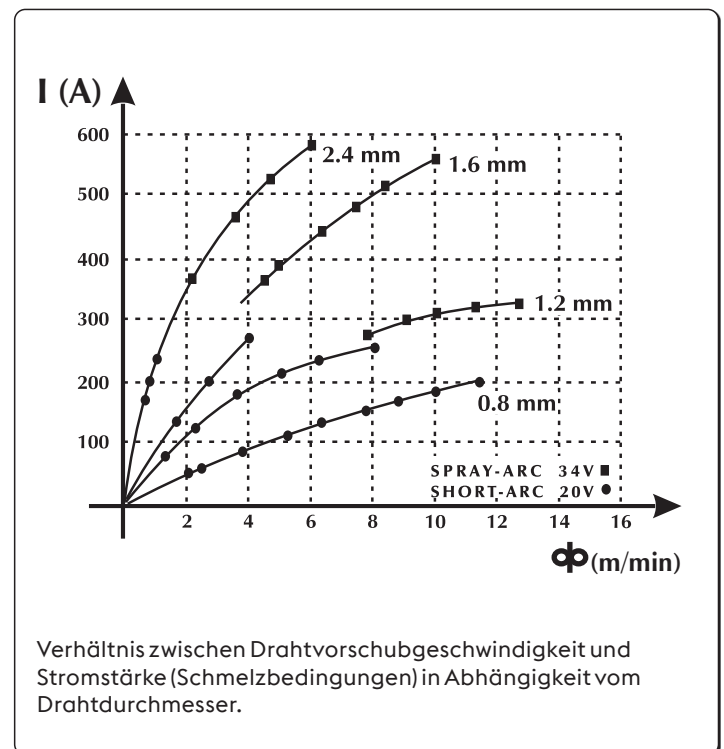
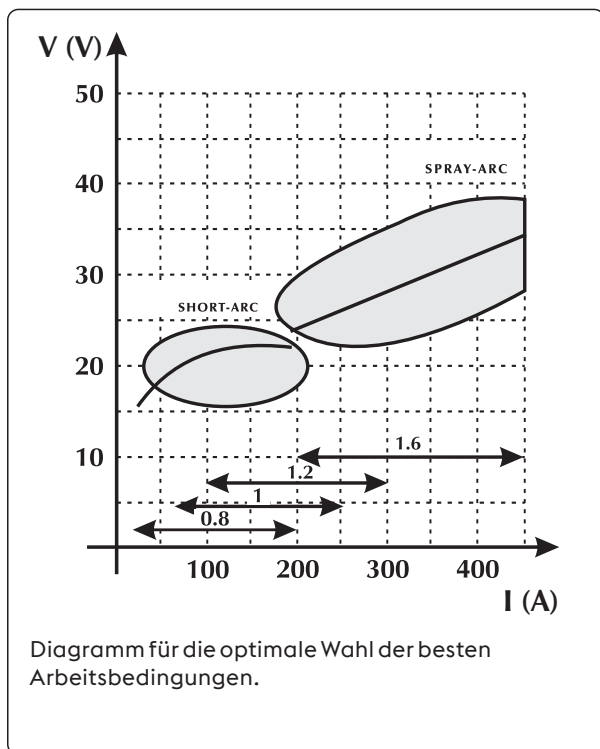
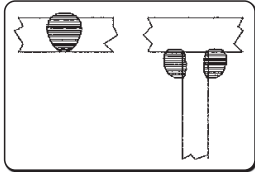
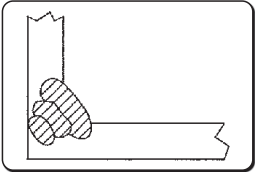
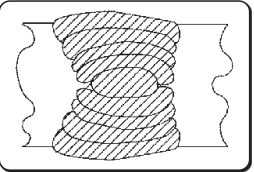
Verwendbare Gase

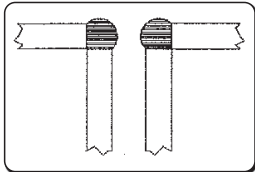
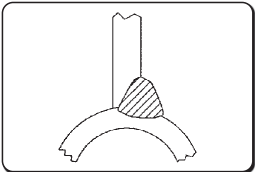
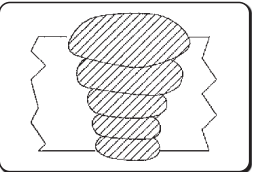
Die MIG-MAG-Schweißung ist vor allem durch den verwendeten Gastyp gekennzeichnet, Inertgase für das MIG-Schweißen (Metal Inert Gas), und Aktivgase für das MAG-Schweißen (Metal Active Gas).

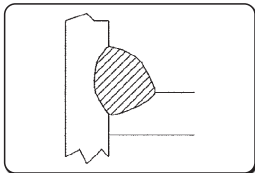
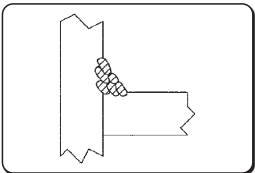
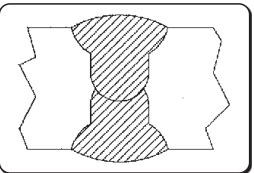
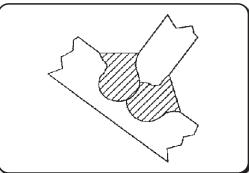
- Kohlendioxid (CO₂)

Mit CO₂ als Schutzgas werden hohe Durchdringungen mit guter Vorschubgeschwindigkeit und guten mechanischen Eigenschaften bei geringen Betriebskosten erreicht. Der Gebrauch dieses Gases verursacht jedoch erhebliche Probleme, was die chemische Endzusammensetzung der Verbindungen betrifft, da man einen Verlust an leicht oxidierbaren Elementen hat und das Bad gleichzeitig mit Kohlenstoff angereichert wird. Das Schweißen mit reinem CO₂ ist auch Grund für andere Probleme, wie zu viele Spritzer und Bildung von Porositäten durch Kohlenmonoxid.

- Argon

Dieses Inertgas wird in reiner Form beim Schweißen von Leichtlegierungen verwendet, wogegen man zum Schweißen von rostfreiem Chrom-Nickelstahl einen 2%-igen Zusatz von Sauerstoff und CO₂ vorzieht, der zur Bogenstabilität und zu einer besseren Form der Schweißnaht beiträgt.

- Helium

Dieses Gas wird anstelle von Argon benutzt und ermöglicht bessere Durchdringungen (auf dickem Material) und höhere Vorschubgeschwindigkeiten.

- Argon-Helium-Mischung

Im Vergleich zu reinem Helium erhält man einen stabileren Bogen, mit mehr Durchdringung und größerer Vorschubgeschwindigkeit als mit Argon.

- Argon-CO₂-Mischung und Argon-CO₂-Sauerstoff-Mischung

Diese Mischungen werden beim Schweißen von Eisenmaterial verwendet, vor allem beim SHORT-ARC-Schweißen, da der spezifische Wärmezusatz verbessert wird. Dies schließt aber den Gebrauch dieser Mischungen für das SPRAY-ARC-Schweißen nicht aus.

Die Mischung enthält gewöhnlich einen CO₂-Anteil von 8% bis 20% und einen O₂-Anteil um 5%.

Lesen Sie die Bedienungsanleitung der Anlage.

10. TECHNISCHE DATEN

Elektrische Eigenschaften			U.M.
Versorgungsspannung U1 (50/60 Hz)	3x230 (±15%)	3x400 (±15%)	Vac
Zmax (@PCC)*	62	62	mΩ
Netzsicherung (träge)	30	20	A
Kommunikation-Bus	DIGITAL	DIGITAL	
Max. Leistungsaufnahme	13.3	13.0	kVA
Max. Leistungsaufnahme	12.8	12.4	kW
Leistungsaufnahme im deaktivierten Zustand	71	71	W
Leistungsfaktor (PF)	0.96	0.95	
Wirkungsgrad (μ)	85	85	%
Cos φ	0.99	0.99	
Max. Stromaufnahme I1max	32.9	18.8	A
Effektivstrom I1eff	20.8	13.3	A
Arbeitsbereich (MMA)	3-320	3-320	A
Leerlaufspannung Uo	75	75	Vdc

* Diese Anlage entspricht der EN / IEC 61000-3-11.

* Die Anlage entspricht der Norm EN / IEC 61000-3-12, wenn die maximal zulässige Netzimpedanz an der Schnittstelle zum öffentlichen Netz (Netzübergabestelle) kleiner oder gleich dem festgelegten Wert Zmax ist. Wenn sie an ein öffentliches Niederspannungsversorgungsnetz angeschlossen wird, liegt es in der Verantwortung des Installateurs oder Betreibers der Anlage sicherzustellen, dass die Anlage angeschlossen werden darf, indem, falls notwendig, der Netzbetreiber konsultiert wird.

Nutzungsfaktor	3x230V	3x400V	U.M.
Nutzungsfaktor MMA (40°C)			
(X=35%)	320	-	A
(X=50%)	-	320	A
(X=60%)	270	300	A
(X=100%)	230	250	A
Nutzungsfaktor MMA (25°C)			
(X=60%)	320	320	A
(X=100%)	270	270	A
Nutzungsfaktor WIG (40°C)			
(X=45%)	320	-	A
(X=60%)	300	320	A
(X=100%)	250	270	A
Nutzungsfaktor WIG (25°C)			
(X=70%)	320	320	A
(X=100%)	270	270	A
Nutzungsfaktor MIG/MAG (40°C)			
(X=35%)	320	-	A
(X=50%)	-	320	A
(X=60%)	280	310	A
(X=100%)	230	250	A
Nutzungsfaktor MIG/MAG (25°C)			
(X=60%)	320	-	A
(X=70%)	-	320	A
(X=100%)	270	270	A

Physikalische Eigenschaften			U.M.
Schutzart IP	IP23S		
Isolationsklasse	H		
Abmessungen (LxBxH)	620x240x460		mm
Gewicht	26.7		Kg
Konstruktionsnormen	EN IEC 60974-1/A1:2019 EN IEC 60974-3:2019 EN 60974-10/A1:2015		
Abschnitt netzkabel	4x4		mm ²
Länge des Versorgungskabel	5		m

11. LEISTUNGSSCHILDER

VOESTALPINE BÖHLER WELDING SELCO S.R.L. Via Palladio, 19 - ONARA (PADOVA) - ITALY			
URANOS NX 3200 PME		N°	
EN IEC 60974-1/A1:2019 60974-10/A1:2015 Class A			
3A/20.0V - 320A (320A)/32.8V (32.8V)			
X (40°C) 50% (35%) 60% 100%			
S	U ₀	I ₂	I ₁
	75V	320A (320A) 300A (270A) 250A (230A)	32.8V (32.8V) 32.0V (30.8V) 30.0V (29.2V)
3A/10.0V - 320A (320A)/22.8V (22.8V)			
X (40°C) (45%) 60% 100%			
S	U ₀	I ₂	I ₁
	75V	(320A) 320A (300A) 270A (250A)	22.8V (22.0V) 20.8V (20.0V)
3A/14.0V - 320A (320A)/30.0V (30.0V)			
X (40°C) 50% (35%) 60% 100%			
S	U ₀	I ₂	I ₁
	75V	320A (320A) 310A (280A) 250A (230A)	30.0V (30.0V) 29.5V (28.5V) 26.5V (25.5V)
U ₁ 400V(230V)		I _{lmax} 18.8A(32.9A)	I _{leff} 13.3A(20.8A)
IP 23 S		MADE IN ITALY	

DE

12. BEDEUTUNG DER ANGABEN AUF DEM LEISTUNGSSCHILD

1		2			
3		4			
5		6			
7	9	23			
		11			
8	10	12	15	16	17
		13	15A	16A	17A
		14	15B	16B	17B
7	9	11			
		11			
8	10	12	15	16	17
		13	15A	16A	17A
		14	15B	16B	17B
18	19	20	21		
22	MADE IN ITALY				

- 1 Marke
- 2 Herstellername und -adresse
- 3 Gerätemodell
- 4 Seriennummer
X**XX**XXXXXXXXXX Baujahr
- 5 Symbol des Schweißmaschinentyps
- 6 Hinweis auf die Konstruktionsnormen
- 7 Symbol des Schweißverfahrens
- 8 Symbol für die Schweißmaschinen, die sich zum Betrieb in Räumen mit großer Stromschlaggefahr eignen
- 9 Symbol des Schweißstroms
- 10 Leerlauf-Nennspannung
- 11 Bereich des Nenn-Höchst- und Nenn-Mindestschweißstroms und der entsprechenden Lastspannung
- 12 Symbol für den unterbrochenen Betrieb
- 13 Symbol des Nenn-Schweißstroms
- 14 Symbol der Nenn-Schweißspannung
- 15 Werte für den unterbrochenen Betrieb
- 16 Werte für den unterbrochenen Betrieb
- 17 Werte für den unterbrochenen Betrieb
- 15A Werte des Nenn-Schweißstroms
- 16A Werte des Nenn-Schweißstroms
- 17A Werte des Nenn-Schweißstroms
- 15B Werte der üblichen Lastspannung
- 16B Werte der üblichen Lastspannung
- 17B Werte der üblichen Lastspannung
- 18 Symbol der Stromversorgung
- 19 Versorgungs-Nennspannung
- 20 Maximale Nennstromaufnahme
- 21 Maximale Effektivstromaufnahme
- 22 Schutzart
- 23 Spitzenspannung Nennwert

CE EU-Konformitätserklärung
 EAC EAC-Konformitätserklärung
 UKCA UKCA-Konformitätserklärung

DÉCLARATION DE CONFORMITÉ UE

Le constructeur

voestalpine Böhler Welding Selco S.r.l. - Via Palladio, 19 - 35019 Onara di Tombolo (PD) - ITALY
Tél. +39 049 9413/111 - Fax +39 049 9413/311 - www.voestalpine.com/welding

déclare sous sa seule responsabilité que le produit suivant:

URANOS NX 3200 PME	55.03.066
	55.03.070

est conforme aux directives EU:

2014/35/EU **LOW VOLTAGE DIRECTIVE**
2014/30/EU **EMC DIRECTIVE**
2011/65/EU **RoHS DIRECTIVE**

et que les normes harmonisées suivantes ont été appliquées:

EN IEC 60974-1/A1:2019	WELDING POWER SOURCE
EN 60974-10/A1:2015	ELECTROMAGNETIC COMPATIBILITY REQUIREMENTS

La documentation certifiant le respect des directives sera tenue à disposition pour les inspections chez le fabricant susmentionné.

Toute intervention ou modification non autorisée par voestalpine Böhler Welding Selco S.r.l. annulera la validité de cette déclaration.

Onara di Tombolo, 15/10/2021

voestalpine Böhler Welding Selco s.r.l.

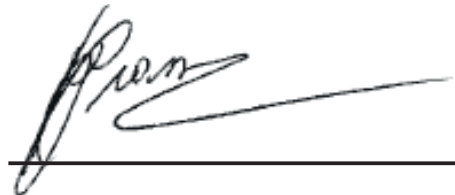

Lino Frasson

INDEX GENERAL

1. AVERTISSEMENT	143
1.1 Environnement d'utilisation	143
1.2 Protection individuelle et de l'entourage	143
1.3 Protection contre les fumées et les gaz	144
1.4 Prévention contre le risque d'incendie et d'explosion	144
1.5 Prévention dans l'emploi de bouteilles de gaz	145
1.6 Protection contre les décharges électriques	145
1.7 Champs électromagnétiques et interférences	145
1.8 Degré de protection IP	146
1.9 Élimination	146
2. INSTALLATION	147
2.1 Mode de soulèvement, de transport et de déchargement	147
2.2 Installation de l'appareil	147
2.3 Branchement et raccordement	147
2.4 Mise en service	148
3. PRÉSENTATION DE L'APPAREIL	150
3.1 Panneau arrière	150
3.2 Panneau prises	150
3.3 Panneau de commande frontal	150
3.4 Panneau de commande frontal	151
4. UTILISATION DE L'INSTALLATION	152
4.1 Ecran de démarrage	152
4.2 Ecran de test	152
4.3 Ecran principal	153
4.4 Écran principal du procédé MMA	153
5. MENU SET UP	160
5.1 Set up et paramétrage des paramètres	160
5.2 Procédures spécifiques d'utilisation des paramètres	170
6. ENTRETIEN	174
6.1 Contrôles périodiques sur le générateur	175
6.2 Responsabilité	175
7. CODES D'ALARMES	175
8. DIAGNOSTIC ET SOLUTIONS	177
9. INFORMATIONS GENERALES SUR LE SOUDAGE	181
9.1 Soudage à l'électrode enrobée (MMA)	181
9.2 Soudage TIG (arc en soudure continue)	181
9.3 Soudage en continu (MIG/MAG)	183
10. CARACTÉRISTIQUES TECHNIQUES	186
11. PLAQUE DONNÉES	187
12. SIGNIFICATION DE LA PLAQUE DES DONNÉES	188
13. SCHÉMA	557
14. CONNECTEURS	559
15. LISTE DE PIÈCES DÉTACHÉES	560

SYMBOLOGIE



Dangers imminents qui causent de graves lésions et comportements risqués qui pourraient causer de graves lésions.



Comportements qui pourraient causer des lésions sans gravité ou des dommages aux biens.



Les notes précédées par ce symbole sont de caractère technique et facilitent les opérations.

1. AVERTISSEMENT



Avant de commencer toute opération, assurez-vous d'avoir bien lu et bien compris ce manuel.

N'apportez pas de modification et n'effectuez pas d'opération de maintenance si elles ne sont pas indiquées dans ce manuel. Le fabricant n'est pas responsable des dommages causés aux personnes ou aux objets en cas de non-respect ou de mise en pratique incorrecte des instructions de ce manuel.

Bewaar de gebruiksaanwijzing altijd op de plaats waar het apparaat wordt gebruikt. Naast de gebruiksaanwijzing dienen ook de algemene regels en plaatselijke voorschriften ter voorkoming van ongevallen en ter bescherming van het milieu in acht te worden genomen.



Ledereen die met de inbedrijfstelling, het gebruik, het onderhoud en de reparatie van het apparaat is belast moet:

- in het bezit zijn van een passende kwalificatie
- over de nodige lasvaardigheden beschikken
- deze gebruiksaanwijzing volledig doorlezen en strikt naleven

Prière de consulter du personnel qualifié en cas de doute ou de problème sur l'utilisation de l'installation, même si elle n'est pas décrite ici.

1.1 Environnement d'utilisation



Chaque installation ne doit être utilisée que dans le but exclusif pour lequel elle a été conçue, de la façon et dans les limites prévues sur la plaque signalétique et/ou dans ce manuel, selon les directives nationales et internationales relatives à la sécurité. Un usage autre que celui expressément déclaré par le fabricant doit être considéré comme inapproprié et dangereux et décharge ce dernier de toute responsabilité.



Cet appareil doit être utilisé exclusivement dans un but professionnel, dans un environnement industriel. Le fabricant n'est pas responsable des dommages causés en cas d'usage domestique.



L'installation doit être utilisée dans un local dont la température est comprise entre -10 et +40°C (entre +14 et +104°F).

L'installation doit être transportée et stockée dans un local dont la température est comprise entre -25 et +55°C (entre -13 et 131°F).

L'installation doit être utilisée dans un local sans poussière, ni acide, ni gaz ou autres substances corrosives.

L'installation ne doit pas être utilisée dans un local dont le taux d'humidité dépasse 50% à 40°C (104°F).

L'installation ne doit pas être utilisée dans un local dont le taux d'humidité dépasse 90% à 20°C (68°F).

L'installation ne doit pas être utilisée à une altitude supérieure à 2000 m au dessus du niveau de la mer (6500 pieds).



Ne pas utiliser cet appareil pour dégeler des tuyaux.

Ne pas utiliser cet appareil pour recharger des batteries et/ou des accumulateurs.

Ne pas utiliser cet appareil pour démarrer des moteurs.

1.2 Protection individuelle et de l'entourage



Le procédé de soudage constitue une source nocive de radiations, de bruit, de chaleur et d'émanations gazeuses. Installer une cloison de séparation ignifuge afin de protéger la zone de soudage des rayons, projections et déchets incandescents. Rappeler aux personnes dans la zone de soudage de ne fixer ni les rayons de l'arc, ni les pièces incandescentes et de porter des vêtements de protection appropriés.



Porter des vêtements de protection afin de protéger la peau contre les rayons de l'arc, les projections ou contre le métal incandescent. Les vêtements portés doivent couvrir l'ensemble du corps et:

- être en bon état
- être ignifuges
- être isolants et secs
- coller au corps et ne pas avoir de revers



Toujours porter des chaussures conformes aux normes, résistantes et en mesure de bien isoler de l'eau.

Toujours utiliser des gants conformes aux normes et en mesure de garantir l'isolation électrique et thermique.



Utiliser un masque avec des protections latérales pour le visage et un filtre de protection adéquat pour les yeux (au moins NR10 ou supérieur).



Toujours porter des lunettes de sécurité avec des coques latérales, particulièrement lors du nettoyage manuel ou mécanique des cordons de soudage.



Ne pas utiliser de lentilles de contact!

FR



Utiliser un casque contre le bruit si le procédé de soudage atteint un niveau de bruit dangereux. Si le niveau de bruit dépasse les limites prescrites par la loi, délimiter la zone de travail et s'assurer que les personnes qui y accèdent portent un casque ou des bouchons de protection.



Toujours laisser les panneaux latéraux fermés durant les opérations de soudage. L'installation ne doit absolument pas être modifiée.



Toujours laisser les panneaux latéraux fermés durant les opérations de soudage. Veiller à ce que les mains, les cheveux, les vêtements, les outils ... ne soient pas en contact avec des pièces en mouvement tels que: ventilateurs, engrenages, galets et arbres, bobines de fil. Ne pas toucher les galets lorsque le dévidage du fil est activé. L'installation ne doit absolument pas être modifiée. Ôter les dispositifs de protection sur les dévidoirs est extrêmement dangereux et décharge le fabricant de toute responsabilité en cas d'accident ou de dommages sur des personnes ou sur des biens.



Ne pas approcher la tête de la torche MIG/MAG durant le chargement et l'avancement du fil. Le fil en sortant peut provoquer des blessures graves aux mains, au visage et aux yeux.



Éviter de toucher les pièces qui viennent d'être soudées car la forte chaleur pourrait provoquer des brûlures graves. Suivre également toutes les précautions indiquées plus haut en fin de soudage car des résidus en cours de refroidissement pourraient se détacher des pièces usinées.



S'assurer que la torche est froide avant d'intervenir dessus ou d'effectuer une opération d'entretien quelconque.



S'assurer que le groupe de refroidissement est éteint avant de déconnecter les tuyaux de circulation du liquide réfrigérant. Le liquide chaud en sortie pourrait provoquer des brûlures graves.



Avoir à disposition une trousse de secours. Ne pas sous-estimer les brûlures ou les blessures.



Avant de quitter le poste de travail, sécuriser la zone afin d'empêcher tout risque d'accident ou de dommages aux personnes ou aux biens.

1.3 Protection contre les fumées et les gaz



Les fumées, les gaz et les poussières produits par le procédé de soudage peuvent être nocifs pour la santé.

Les fumées qui se dégagent durant le processus de soudage peuvent, dans certaines circonstances, provoquer le cancer ou nuire au fœtus chez les femmes enceintes.

- Veiller à ne pas être en contact avec les gaz et les fumées de soudage.
- Prévoir une ventilation adéquate, naturelle ou forcée, dans la zone de travail.
- En cas d'aération insuffisante, utiliser un masque à gaz spécifique.
- En cas d'opérations de soudage dans des locaux de petites dimensions, il est conseillé de faire surveiller l'opérateur par un collègue situé à l'extérieur.
- Ne pas utiliser d'oxygène pour la ventilation.
- S'assurer que l'aspiration est efficace en contrôlant régulièrement si les gaz nocifs ne dépassent pas les valeurs admises par les normes de sécurité.
- La quantité et le niveau de risque des fumées produites dépendent du métal de base utilisé, du métal d'apport et des substances éventuelles utilisées pour nettoyer et dégraisser les pièces à souder. Suivre attentivement les instructions du fabricant et les fiches techniques correspondantes.
- Ne pas effectuer d'opérations de soudage à proximité d'ateliers de dégraissage ou de peinture.
- Placer les bouteilles de gaz dans des endroits ouverts ou dans un local bien aéré.

1.4 Prévention contre le risque d'incendie et d'explosion



Le procédé de soudage peut causer des incendies et/ou des explosions.

- Débarrasser la zone de travail et ses abords de tous les matériaux et objets inflammables ou combustibles.
- Les matériaux inflammables doivent se trouver à au moins 11 mètres (35 pieds) de la zone de soudage et être entièrement protégés.
- Les projections et les particules incandescentes peuvent facilement être projetées à distance, même à travers des fissures. Veiller à ce que les personnes et les biens soient à une distance suffisante de sécurité.
- Ne pas effectuer de soudures sur ou à proximité de récipients sous pression.

- Ne pas effectuer d'opérations de soudage ou de découpage sur des containers ou des tubes fermés. Faire très attention au moment de souder des tuyaux ou des containers, même ouverts, vidés et nettoyés soigneusement. Des résidus de gaz, de carburant, d'huile ou autre pourraient provoquer une explosion.
- Ne pas souder dans une atmosphère contenant des poussières, des gaz ou des vapeurs explosives.
- S'assurer, en fin de soudage, que le circuit sous tension ne peut pas toucher accidentellement des pièces connectées au circuit de masse.
- Installer à proximité de la zone de travail un équipement ou un dispositif anti-incendie.

1.5 Prévention dans l'emploi de bouteilles de gaz



Les bouteilles de gaz inertes contiennent du gaz sous pression et peuvent exploser si les conditions requises en matière de transport, de conservation et d'utilisation ne sont pas garanties.

- Les bouteilles doivent être rangées verticalement contre le mur ou contre un support et être maintenues par des moyens appropriés pour qu'elles ne tombent pas et éviter des chocs mécaniques accidentels.
- Visser le capuchon pour protéger la valve durant le transport ou la mise en service et chaque fois que les opérations de soudage sont terminées.
- Ne pas laisser les bouteilles au soleil et ne pas les exposer aux gros écarts de températures trop élevées ou trop extrêmes. Ne pas exposer les bouteilles à des températures trop basses ou trop élevées.
- Veiller à ce que les bouteilles ne soient pas en contact avec une flamme, avec un arc électrique, avec une torche ou une pince porte-électrodes, ni avec des projections incandescentes produites par le soudage.
- Garder les bouteilles loin des circuits de soudage et des circuits électriques en général.
- Éloigner la tête de l'orifice de sortie du gaz au moment d'ouvrir la valve de la bouteille.
- Toujours refermer la valve de la bouteille quand les opérations de soudage sont terminées.
- Ne jamais souder une bouteille de gaz sous pression.
- Ne jamais relier une bouteille d'air comprimé directement au réducteur de pression de la machine! Si la pression dépasse la capacité du réducteur, celui-ci pourrait exploser!

1.6 Protection contre les décharges électriques



Une décharge électrique peut être mortelle.

- Éviter de toucher les parties normalement sous tension à l'intérieur ou à l'extérieur de l'installation de soudage quand cette dernière est alimentée (les torches, les pinces, les câbles de masse, les électrodes, les fils, les galets et les bobines sont branchés au circuit de soudage).
- Garantir l'isolation de l'installation et de l'opérateur en utilisant des sols et des plans secs et suffisamment isolés de la terre.
- S'assurer que l'installation soit connectée correctement à une fiche et à un réseau muni d'un conducteur de mise à la terre.
- Ne pas toucher en même temps deux torches ou deux pinces porte-électrodes.
- Interrompre immédiatement les opérations de soudage en cas de sensation de décharge électrique.

1.7 Champs électromagnétiques et interférences



Le passage du courant dans les câbles à l'intérieur et à l'extérieur de l'installation crée un champ électromagnétique à proximité de cette dernière et des câbles de soudage.

- Les champs électromagnétiques peuvent avoir des effets (jusqu'ici inconnus) sur la santé de ceux qui y sont exposés pendant un certain temps.
- Les champs électromagnétiques peuvent interférer avec d'autres appareils tels que les stimulateurs cardiaques ou les appareils acoustiques.



Les personnes qui portent un stimulateur cardiaque (pacemaker) ou un appareil auditif doivent consulter le médecin avant d'effectuer des opérations de soudure à l'arc.

1.7.1 Classification CEM selon la norme: EN 60974-10/A1:2015.

Classe
B

Los dispositivos de clase B cumplen con los requisitos de compatibilidad electromagnética en entornos industriales y residenciales, incluyendo las áreas residenciales en las que la energía eléctrica se suministra desde un sistema público de baja tensión.

Classe
A

Los dispositivos de clase A no están destinados al uso en áreas residenciales en las que la energía eléctrica se suministra desde un sistema público de baja tensión. Il pourrait être difficile d'assurer la compatibilité électromagnétique d'appareils de classe A dans de tels environnements, en raison de perturbations par rayonnement ou conduction.

Pour plus d'informations, consultez le chapitre: PLAQUE DONNÉES ou CARACTÉRISTIQUES TECHNIQUES.

1.7.2 Installation, utilisation et évaluation de la zone

Ce matériel a été fabriqué conformément aux dispositions relatives à la norme harmonisée EN 60974-10/A1:2015 et est considéré comme faisant partie de la "CLASSE A". Cet appareil doit être utilisé exclusivement dans un but professionnel, dans un environnement industriel. Le fabricant n'est pas responsable des dommages causés en cas d'usage domestique.



L'utilisateur, qui doit être un expert dans le domaine, est responsable en tant que tel de l'installation et de l'utilisation de l'appareil selon les instructions du constructeur. Si des perturbations électromagnétiques apparaissent, il est de la responsabilité de l'utilisateur de résoudre le problème en demandant conseil au service après-vente du constructeur.



Dans tous les cas, les perturbations électromagnétiques doivent être réduites de manière à ne plus représenter une gêne.



Avant l'installation de l'appareil, l'utilisateur devra évaluer les problèmes électromagnétiques potentiels qui pourraient survenir aux abords de la zone de travail et en particulier sur la santé des personnes situées à proximité (personnes portant un pacemaker ou un appareil auditif).

1.7.3 Exigences de l'alimentation de secteur

Le courant primaire peut entraîner des distortions du réseau sur les appareils de forte puissance. Aussi les restrictions et exigences de connexion sur les impédances maximum autorisées du réseau (Z_{max}) ou sur la capacité d'alimentation minimum (S_{sc}) requise au point d'interface du réseau public (point de couplage commun, PCC), peuvent s'appliquer à quelques modèles d'appareils (se reporter aux caractéristiques techniques). Dans ce cas, il est de la responsabilité de l'installateur ou de l'utilisateur de l'appareil de s'assurer, en consultant l'opérateur de réseau de distribution si nécessaire, que l'appareil peut être connecté. En cas d'interférence, il pourrait être nécessaire de prendre des précautions supplémentaires, telles que le filtrage de l'alimentation de secteur.

Il faut également envisager la possibilité de blinder le câble d'alimentation.

Pour plus d'informations, consultez le chapitre: CARACTÉRISTIQUES TECHNIQUES.

1.7.4 Précautions concernant les câbles

Se conformer aux règles suivantes pour réduire les effets des champs électromagnétiques:

- Enrouler l'un avec l'autre et fixer, quand cela est possible, le câble de masse et le câble de puissance.
- Ne jamais enrouler les câbles autour du corps.
- Ne pas se placer entre le câble de masse et le câble de puissance (les mettre tous les deux du même côté).
- Les câbles doivent rester les plus courts possible, être placés proche l'un de l'autre à même le sol ou près du niveau du sol.
- Placer l'installation à une certaine distance de la zone de soudage.
- Les câbles ne doivent pas être placés à proximité d'autres câbles.

1.7.5 Branchement equipotentiel

Le branchement à la masse de tous les composants métalliques de l'installation de soudage (découpage) et adjacents à cette installation doit être envisagé. Respecter les normes nationales concernant la branchement equipotentiel.

1.7.6 Mise a la terre de la pièce à souder

Quand la pièce à souder n'est pas reliée à la terre, pour des motifs de sécurité électrique ou à cause de son encombrement et de sa position, un branchement reliant la pièce à la terre pourrait réduire les émissions. Il faut veiller à ce que la mise à la terre de la pièce à souder n'augmente pas le risque d'accident pour les utilisateurs ou de dommages sur d'autres appareils électriques. Respecter les normes nationales concernant la mise à la terre.

1.7.7 Blindage

Le blindage sélectif d'autres câbles et appareils présents à proximité de la zone peut réduire les problèmes d'interférences. Le blindage de toute l'installation de soudage peut être envisagé pour des applications spéciales.

1.8 Degré de protection IP



IP23S

- Boîtier de protection contre l'accès aux parties dangereuses par un doigt et contre des corps solides étrangers ayant un diamètre supérieur/égal à 12.5 mm.
- Grille de protection contre une pluie tombant à 60°.
- Boîtier protégé contre les effets nuisibles dus à la pénétration d'eau lorsque les parties mobiles de l'appareil ne sont pas encore en fonctionnement.

1.9 Élimination



Ne pas éliminer les équipements électriques avec les déchets ménagers !

Conformément à la Directive européenne 2012/19/UE relative aux déchets d'équipements électriques et électroniques et à sa mise en œuvre conformément aux lois nationales, les équipements électriques qui ont atteint la fin de leur cycle de vie doivent être collectés séparément et envoyés à un centre de récupération et d'élimination. Le propriétaire de l'équipement doit identifier les centres de collecte agréés en se renseignant auprès des autorités locales. L'application de la Directive Européenne permettra de respecter l'environnement et la santé des êtres humains.

2. INSTALLATION



L'installation ne peut être effectuée que par du personnel expérimenté et agréé par le constructeur.



Pendant l'installation, s'assurer que le générateur est déconnecté du réseau.



Il est interdit de connecter, en série ou en parallèle, des générateurs.

2.1 Mode de soulèvement, de transport et de déchargement

- L'appareil est équipé d'une poignée permettant le portage à la main.
- La machine ne dispose d'aucun élément spécifique pour le levage.
- Utiliser un chariot élévateur à fourches en faisant très attention au moment de déplacer le générateur afin d'éviter de le faire basculer.



Ne pas sous-évaluer le poids de l'installation, se reporter aux caractéristiques techniques.

Ne pas faire passer ou arrêter la charge suspendue au-dessus de personnes ou d'objets.

Ne pas laisser tomber le matériel ou ne pas créer de pression inutile sur l'appareil.

2.2 Installation de l'appareil



Observer les règles suivantes:

- Réserver un accès facile aux commandes et aux connexions de l'appareil.
- Ne pas installer l'appareil dans des locaux de petites dimensions.
- Ne jamais placer la machine sur un plan incliné de plus de 10° par rapport à l'horizontale.
- Installer le matériel dans un endroit sec, propre et avec une aération appropriée.
- Mettre l'installation à l'abri de la pluie battante et ne pas l'exposer aux rayons du soleil.

2.3 Branchement et raccordement



Le générateur est doté d'un câble d'alimentation pour le branchement au réseau.

L'appareil peut être alimenté en:

- 400V triphasé
- 230V triphasé

Le fonctionnement de l'appareil est garanti pour des tensions avec une tolérance de $\pm 15\%$ par rapport à la valeur nominale.



Contrôler la tension sélectionnée et les fusibles AVANT de brancher la machine au réseau pour éviter des dommages aux personnes ou à l'installation. Contrôler également si le câble est branché à une prise munie d'un contact de terre.



L'appareil peut être alimenté par groupe électrogène à condition que celui-ci garantisse une tension d'alimentation stable entre $\pm 15\%$ par rapport à la valeur de tension nominale déclarée par le fabricant, dans toutes les conditions de fonctionnement possibles et à la puissance maximale pouvant être fournie par le générateur. Il est généralement conseillé d'utiliser un groupe électrogène dont la puissance est égale à 2 fois celle du générateur s'il est monophasé et à 1.5 fois s'il est triphasé. Il est conseillé d'utiliser un groupe électrogène à contrôle électronique.



L'installation doit être branchée correctement à la terre pour garantir la sécurité des utilisateurs. Le conducteur (jaune - vert) fourni pour la mise à la terre du câble d'alimentation doit être branché à une fiche munie d'un contact de terre. Ce fil jaune/vert ne doit JAMAIS être utilisé avec d'autres conducteurs de tension. S'assurer que la mise à la terre est bien présente dans l'installation utilisée et vérifier le bon état des prises de courant. Utiliser exclusivement des fiches homologuées conformes aux normes de sécurité.



L'installation électrique doit être réalisée par un personnel technique qualifié, et conformément aux lois du pays dans lequel est effectuée cette opération.

2.4 Mise en service

2.4.1 Raccordement pour le soudage MMA



Le branchement décrit ci-dessous donne comme résultat une soudure avec une polarité inverse. Inverser le branchement pour obtenir une soudure avec une polarité directe.

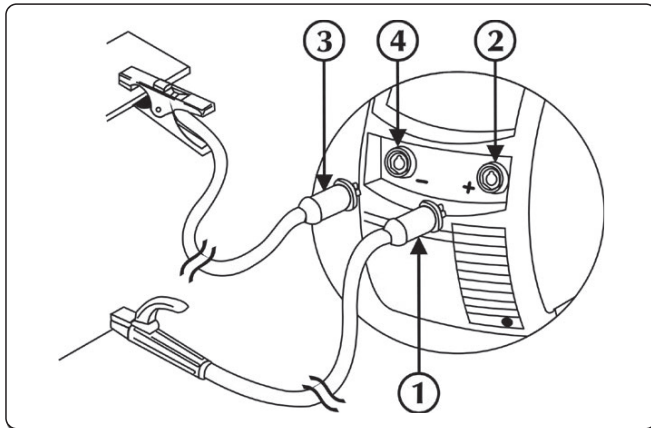

- ① Connecteur de pince de terre
- ② Raccord de puissance négative (-)
- ③ Connecteur de pince porte-électrode
- ④ Raccord de puissance positive (+)

- ▶ Brancher le connecteur du câble de la pince de masse à la prise négative (-) du générateur. Introduire la prise et tourner dans le sens des aiguilles d'une montre jusqu'à ce que les parties soient bien fixées.
- ▶ Brancher le connecteur du câble de la pince porte-électrode à la prise positive (+) du générateur. Introduire la prise et tourner dans le sens des aiguilles d'une montre jusqu'à ce que les parties soient bien fixées.

2.4.2 Raccordement pour le soudage TIG

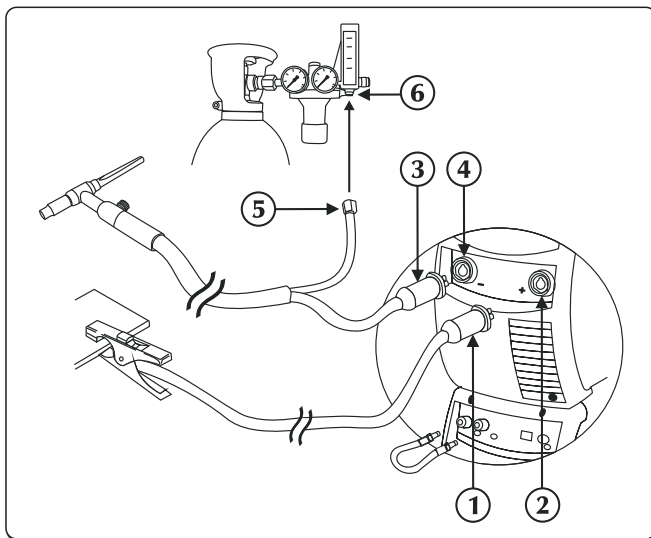



- ① Connecteur de pince de terre
- ② Raccord de puissance positive (+)
- ③ Raccord torche TIG
- ④ Prise de torche
- ⑤ Connecteur de tuyau de gaz
- ⑥ Réducteur de pression

- ▶ Brancher le connecteur de câble de la pince de masse à la prise positive (+) du générateur. Introduire la prise et tourner dans le sens des aiguilles d'une montre jusqu'à ce que les parties soient bien fixées.
- ▶ Brancher le raccord de la torche TIG à la prise de la torche du générateur. Introduire la prise et tourner dans le sens des aiguilles d'une montre jusqu'à ce que les parties soient bien fixées.



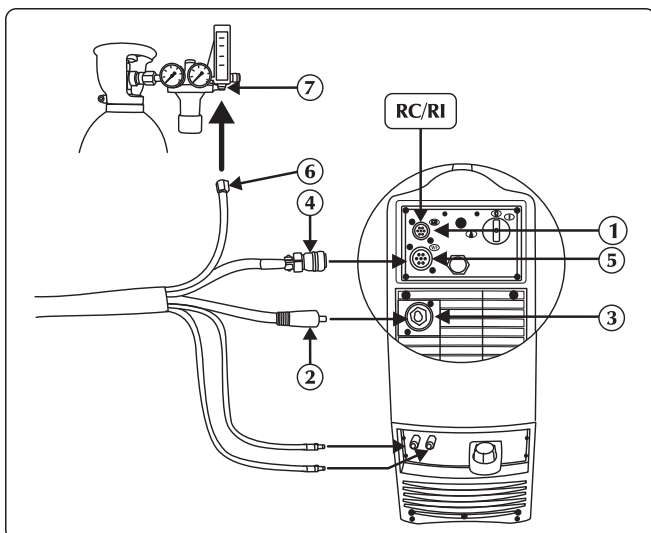

Régler le débit de gaz de protection à l'aide d'un robinet généralement positionné sur la torche.

- ▶ Brancher séparément le connecteur du tuyau de gaz de la torche au réseau de distribution du gaz.
- ▶ Relier le tuyau du liquide de refroidissement de la torche (symbole rouge) au raccord rapide d'entrée (symbole rouge ) du refroidisseur.
- ▶ Relier le tuyau du liquide de refroidissement de la torche (symbole bleu) au raccord rapide (symbole bleu ) de sortie du refroidisseur.

2.4.3 Raccordement pour le soudage MIG/MAG

- ① Entrée du câble d'interface (CAN-BUS)
- ② Câble de puissance
- ③ Raccord de puissance positive (+)
- ④ Câble de signal
- ⑤ Entrée du câble de signal (CAN-BUS) (faisceau de câbles)
- ⑥ Tuyau gaz
- ⑦ Raccordement de l'alimentation en gaz

- ▶ Brancher le câble de puissance au connecteur correspondant. Introduire la prise et tourner dans le sens des aiguilles d'une montre jusqu'à ce que les parties soient bien fixées.
- ▶ Brancher le câble d'interface au connecteur correspondant. Introduire le connecteur et tourner la bague dans le sens des aiguilles d'une montre jusqu'à un serrage parfait et sécurisé des pièces.
- ▶ Relier le tuyau de gaz au réducteur de pression de la bouteille ou au raccord d'alimentation du gaz. Régler le débit du gaz de 10 à 30 l/min.
- ▶ Relier le tuyau du liquide de refroidissement (symbole bleu) au raccord rapide (symbole bleu ) de sortie du refroidisseur.
- ▶ Relier le tuyau du liquide de refroidissement (symbole rouge) au raccord rapide d'entrée (symbole rouge ) du refroidisseur.

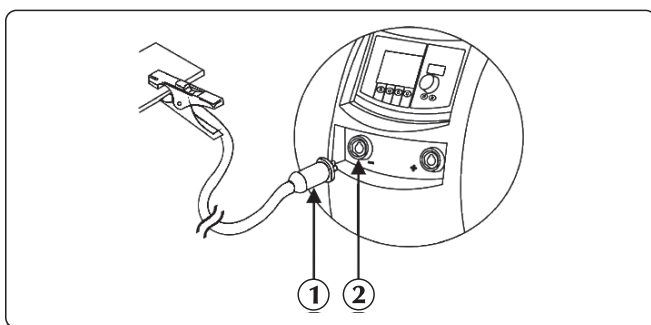

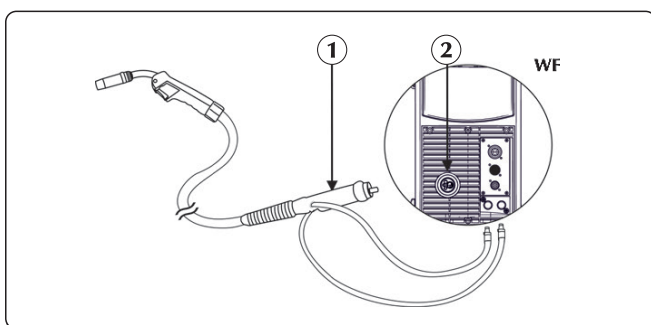

- ① Connecteur de pince de terre
- ② Raccord de puissance négative (-)

- ▶ Brancher le connecteur du câble de la pince de masse à la prise négative (-) du générateur. Introduire la prise et tourner dans le sens des aiguilles d'une montre jusqu'à ce que les parties soient bien fixées.



- ① Raccord torche
- ② Connecteur

- ▶ Relier le tuyau du liquide de refroidissement de la torche (symbole bleu) au raccord rapide (symbole bleu ) de sortie du refroidisseur.
- ▶ Relier le tuyau du liquide de refroidissement de la torche (symbole rouge) au raccord rapide d'entrée (symbole rouge ) du refroidisseur.
- ▶ Brancher la torche MIG/MAG au raccord central, en s'assurant du bon serrage de la connexion.

FR

3. PRÉSENTATION DE L'APPAREIL

3.1 Panneau arrière

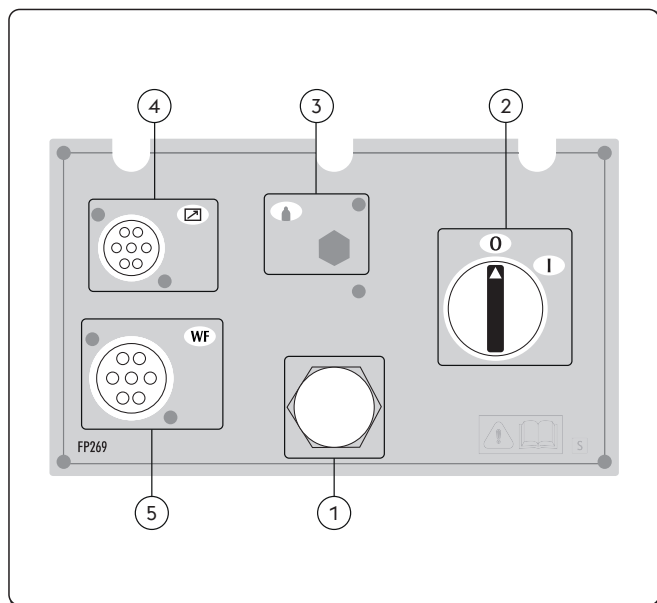

- ① **Câble d'alimentation**
Il permet d'alimenter l'installation en la branchant au secteur.
- ② **Interrupteur Marche/arrêt**
Il commande l'allumage électrique du générateur. Il a deux positions, "0" éteint, "I" allumé.
- ③ **Non utilisé**
- ④ **Entrée du câble d'interface CAN-BUS (RC, RI...)**
- ⑤ **Entrée du câble de signal (CAN-BUS) (faisceau de câbles)**

3.2 Panneau prises

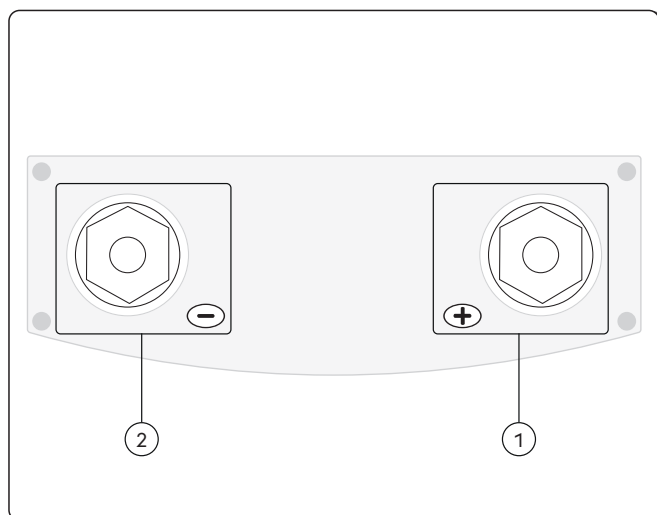

- ① **Raccord de puissance positive (+)**
Processus MMA: Connexion torche d'électrode
Processus TIG: Connexion câble de masse
- ② **Raccord de puissance négative (-)**
Processus MMA: Connexion câble de masse
Processus TIG: Connexion torche
Procédé MIG/MAG: Connexion câble de masse



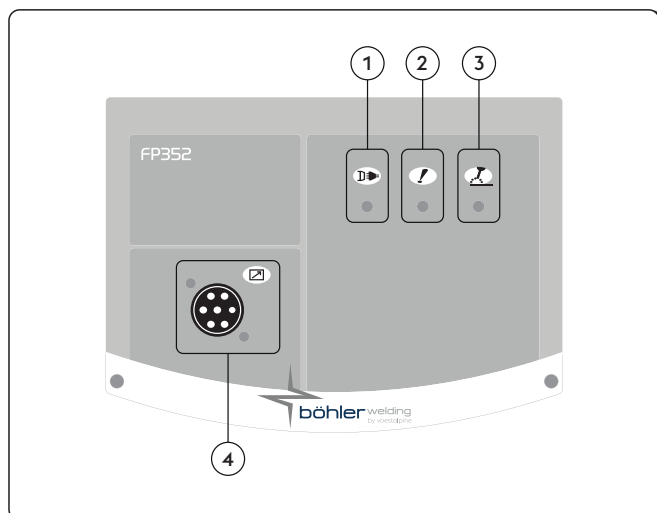



3.3 Panneau de commande frontal

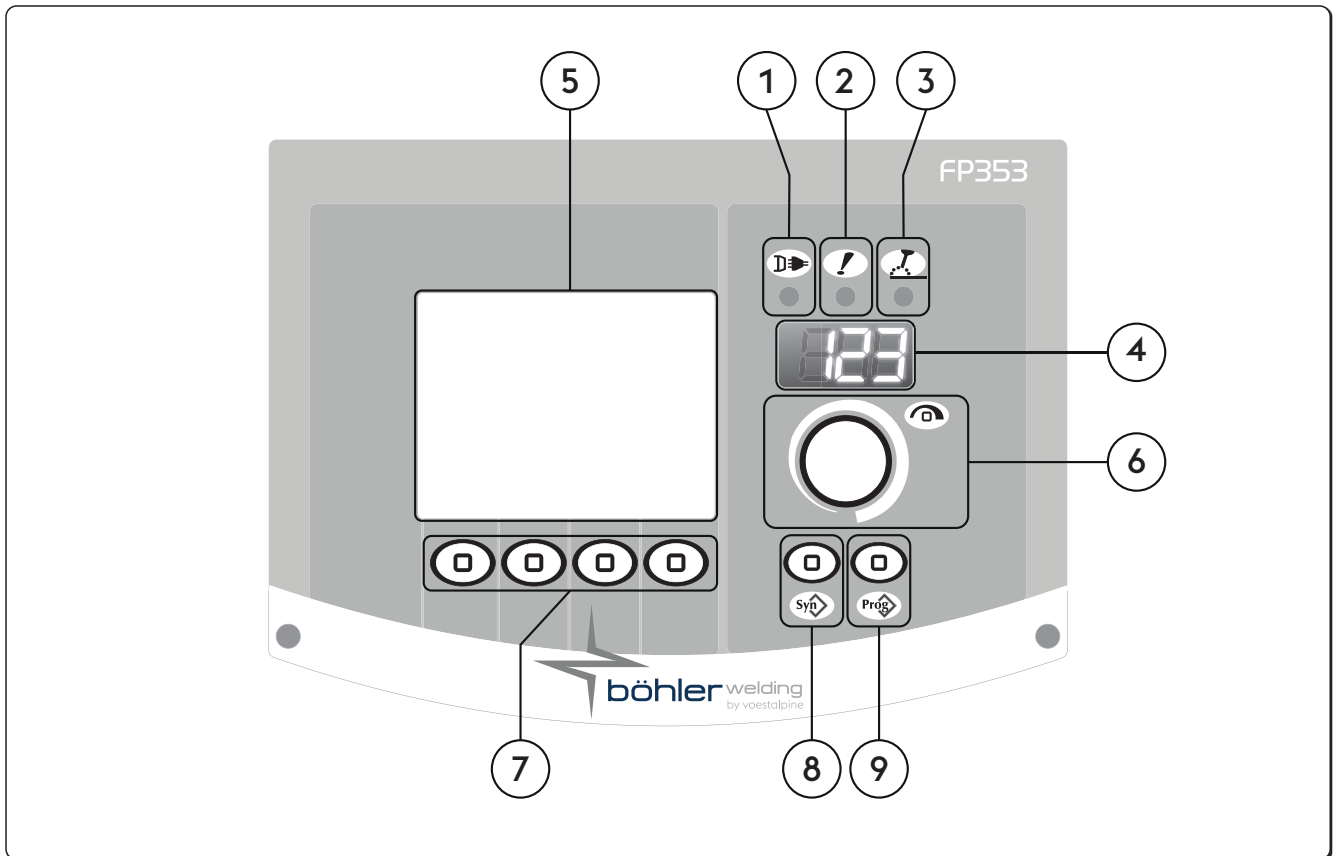

- ① **LED d'alimentation**
Indique que le générateur est connecté au réseau et qu'il est sous tension.
- ② **LED d'alarme générale**
Indique l'intervention possible des systèmes de protection, tels que la protection thermique.
- ③ **LED de puissance active**
Indique la présence de tension sur les connexions de sortie du générateur.
- ④ **Entrée du câble d'interface CAN-BUS (RC, RI...)**

3.4 Panneau de commande frontal



- ①  **LED d'alimentation**
Indique que le générateur est connecté au réseau et qu'il est sous tension.
- ②  **LED d'alarme générale**
Indique l'intervention possible des systèmes de protection, tels que la protection thermique.
- ③  **LED de puissance active**
Indique la présence de tension sur les connexions de sortie du générateur.
- ④  **Affichage des données**
Permet l'affichage des différents paramètres de soudage lors de la mise en route, des réglages, la lecture de l'intensité et de la tension pendant le soudage, ainsi que la codification des défauts.
- ⑤  **LCD display**
Permet l'affichage des différents paramètres de soudage lors de la mise en route, des réglages, la lecture de l'intensité et de la tension pendant le soudage, ainsi que la codification des défauts.
Permet l'affichage instantané de toutes les opérations.
- ⑥  **Bouton de réglage principal**
Permet l'accès au menu et la sélection et le réglage des paramètres de soudage.
- ⑦  **Touches de fonction**
Permet la sélection des diverses fonctions du système:
 - Procésos de soldadura
 - Procédures de soudage
 - Courant de pulsation
 - Mode graphique

8 **Touche des programmes**

Permet la sélection d'un programme de soudage préselectionné en choisissant quelques réglages simples:

- Type de fil
- Type de gaz
- Diamètre de fil

9 **Touche job**

Permet l'enregistrement et la gestion de 240 programmes de soudage qui peuvent être personnalisés par l'opérateur.

4. UTILISATION DE L'INSTALLATION

4.1 Ecran de démarrage

Dès sa mise en route, le générateur va procéder à une série de tests afin de garantir le fonctionnement correct de l'appareil et des dispositifs connectés. A ce stade, le test gaz est également activé pour vérifier la connexion correcte du système d'alimentation gaz.

4.2 Ecran de test

Lorsque le panneau latéral (compartiment bobine) est ouvert, les opérations de soudage sont indisponibles. L'écran test apparaît sur l'afficheur LCD.

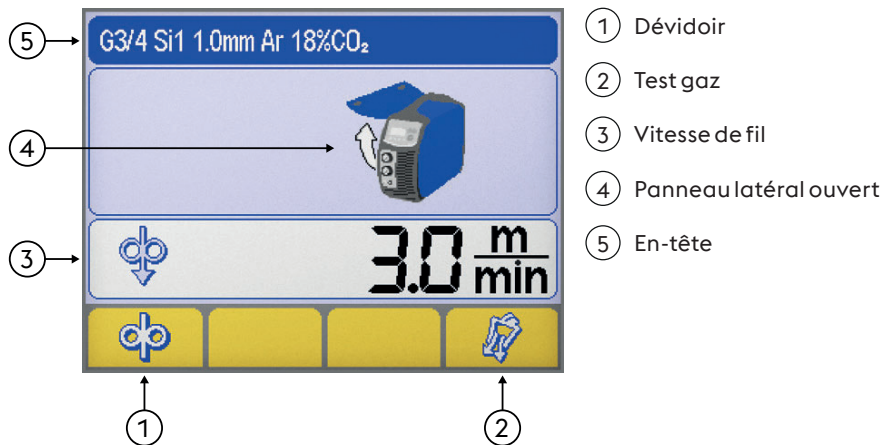

Dévidoir

Permet l'avance manuelle du fil sans apport de gaz et sans que le fil soit alimenté. Permet l'insertion du fil dans la gaine de torche durant les phases de préparation du soudage.



Test gaz

Permet au circuit de gaz de se libérer d'éventuelles impuretés et de procéder aux réglages préliminaires de débit et de pression de gaz sans que l'alimentation soit branchée.



Vitesse du fil

Permet le réglage de la vitesse d'avance de fil (au cours de l'étape de chargement).

Minimum	Maximum	Réglage par défaut
0.5 m/min	22.0 m/min	3.0 m/min



Panneau latéral ouvert



En-tête

Permet l'affichage de certaines informations importantes relatives au procédé sélectionné.

4.3 Ecran principal

Permet la gestion de l'équipement et du procédé de soudage, en affichant les réglages principaux.

4.4 Écran principal du procédé MMA

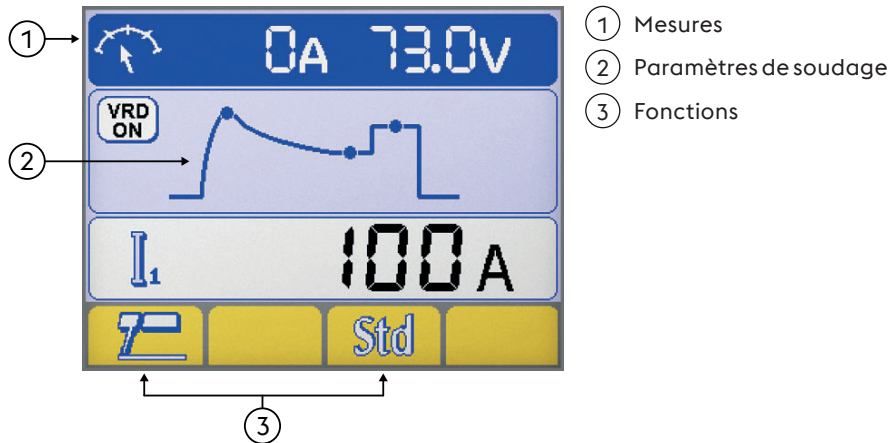

Mesures

Durant l'opération de soudage, les valeurs de tension et courant réels sont affichées sur l'afficheur LCD.

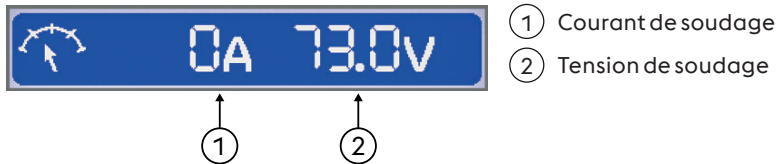

Paramètres de soudage

► Sélectionner le paramètre choisi en appuyant sur le bouton de réglage.

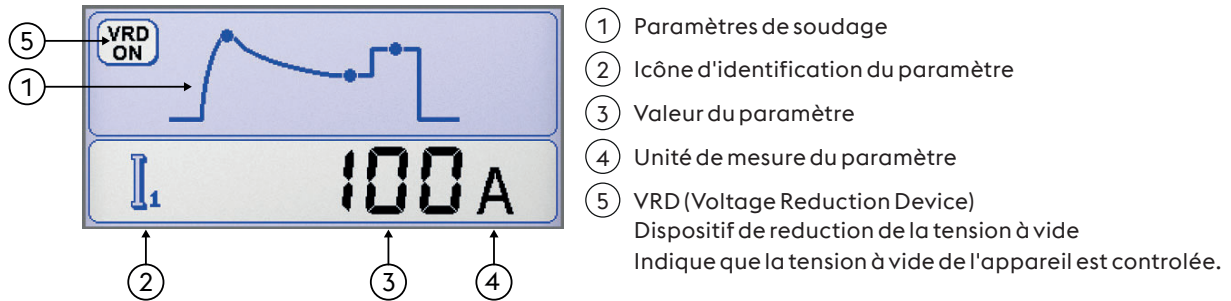

Fonctions

Permet la sélection des plus importantes fonctions de procédé et de mode de soudage.





Synergie MMA

Pour saisir la meilleure dynamique d'arc en sélectionnant le type d'électrode utilisée. La sélection de la bonne dynamique d'arc permet de bénéficier de générateur pour obtenir les meilleures performances de soudage.



La soudabilité parfaite de l'électrode utilisée n'est pas garantie. La soudabilité dépend de la qualité des consommables et de leur stockage, des conditions de soudage et d'utilisation, des applications possibles nombreuses..

4.5 Écran principal du procédé TIG

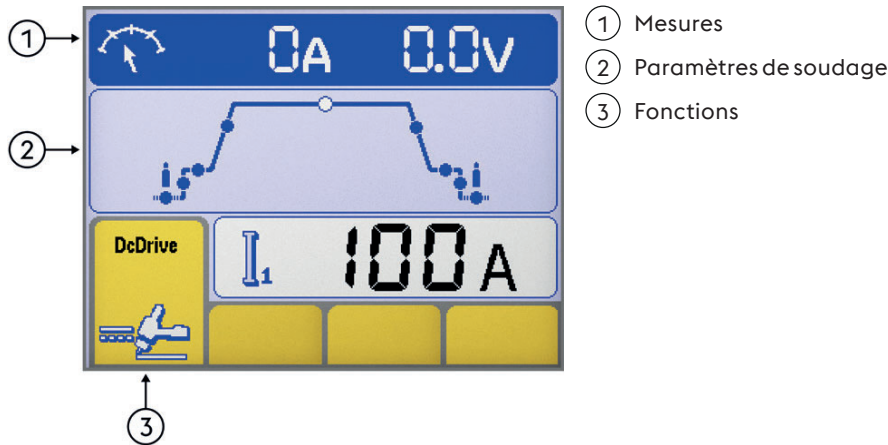

FR

Mesures

Durant l'opération de soudage, les valeurs de tension et courant réels sont affichées sur l'afficheur LCD.

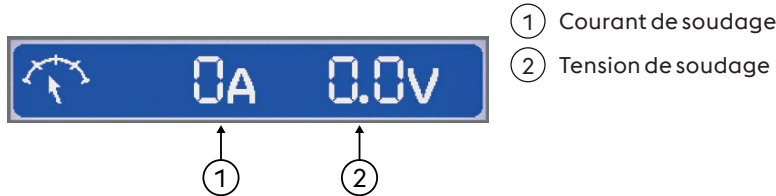

Paramètres de soudage

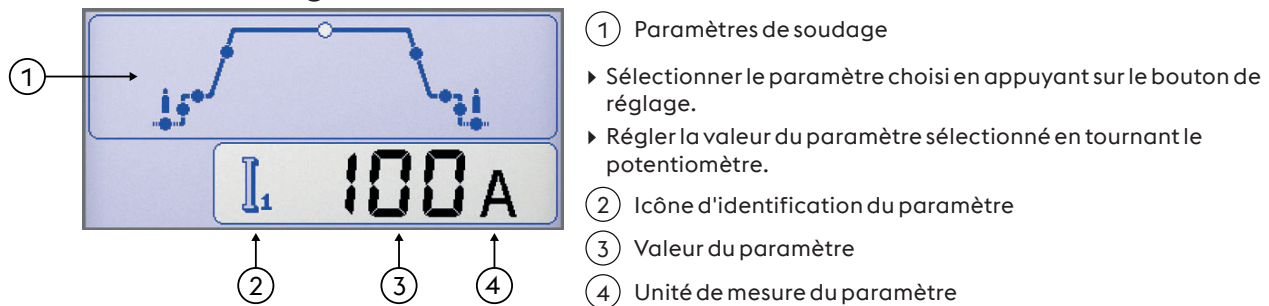

Fonctions

Permet la sélection des plus importantes fonctions de procédé et de mode de soudage.

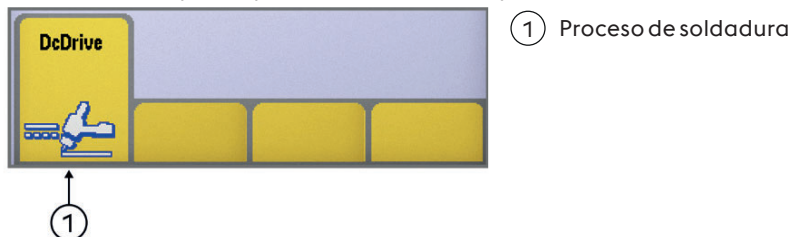

Proceso de soldadura

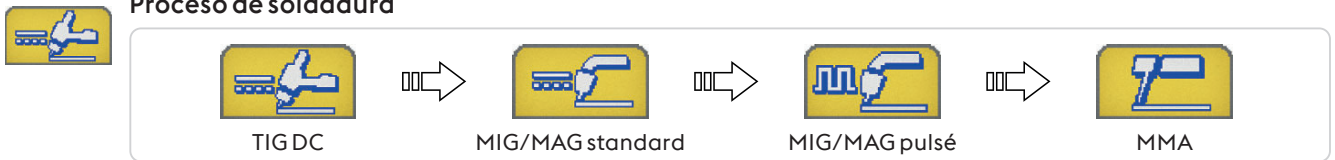

4.6 Écran principal du procédé MIG/ MAG

Écran de base

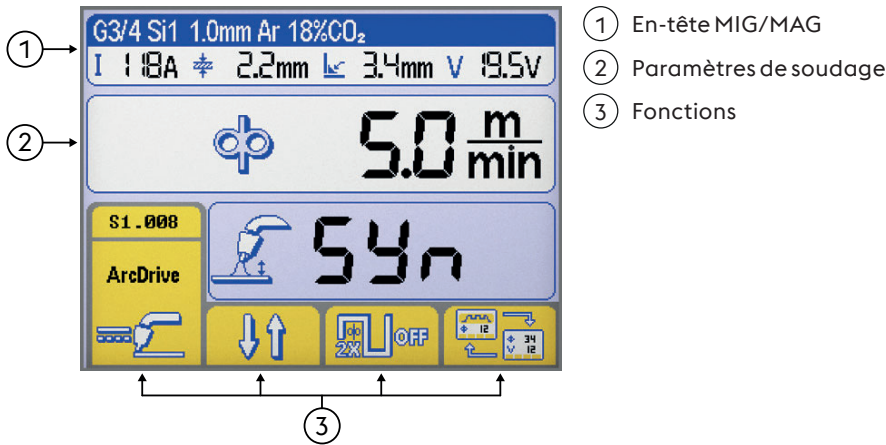

Écran graphique

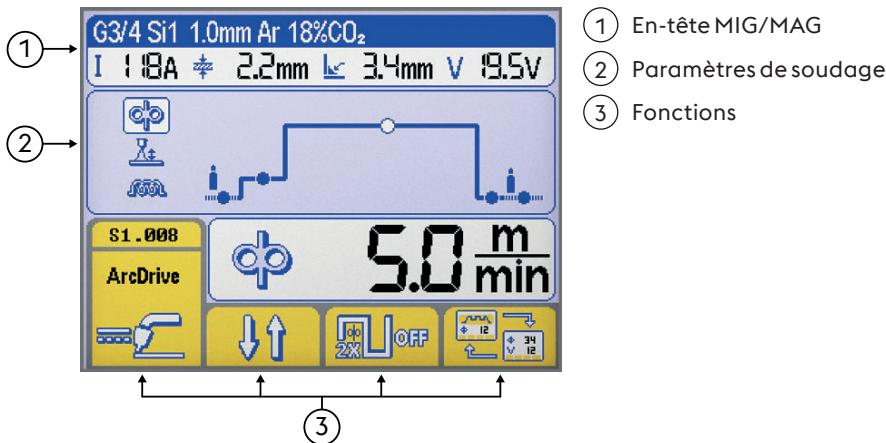

En-tête MIG/MAG

Permet l'affichage de certaines informations importantes relatives au procédé sélectionné.

G3/4 Si1 1.0mm Ar 18%CO₂

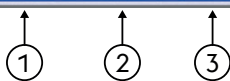

Courbe synergique sélectionnée

- ① Type de métal d'apport
- ② Diamètre de fil
- ③ Type de gaz

I 118A 2.2mm 3.4mm V 19.5V



Paramètres de soudage

- ① Courant de soudage
- ② Épaisseur de la pièce
- ③ Cordon d'angle
- ④ Tension de soudage

Paramètres de soudage (Écran de base)

► Sélectionner le paramètre choisi en appuyant sur le bouton de réglage.

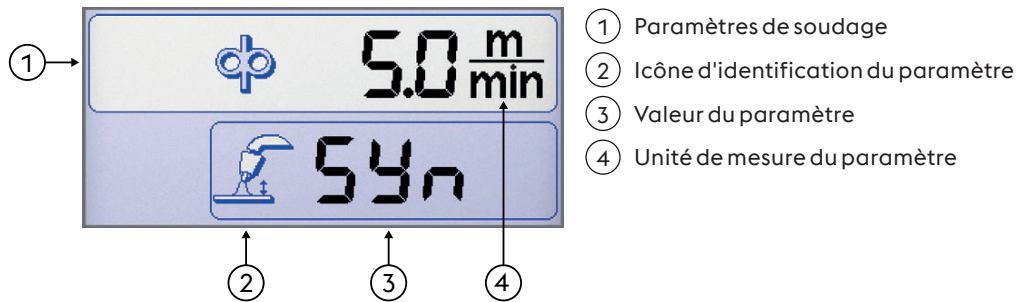

Paramètres de soudage (Écran graphique)

► Sélectionner le paramètre choisi en appuyant sur le bouton de réglage.

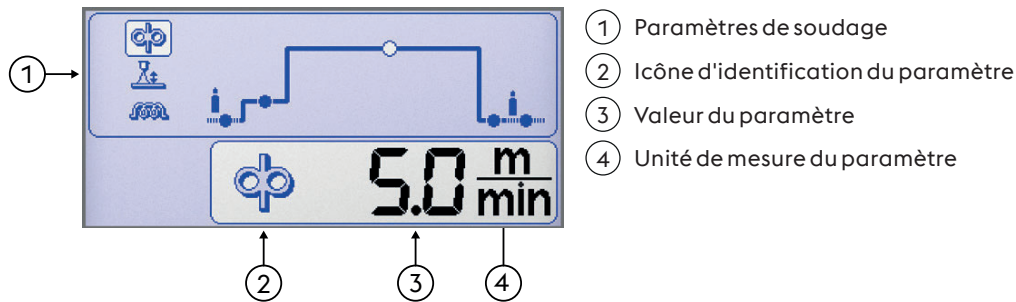

FR

Fonctions

Permet la sélection des plus importantes fonctions de procédé et de mode de soudage.

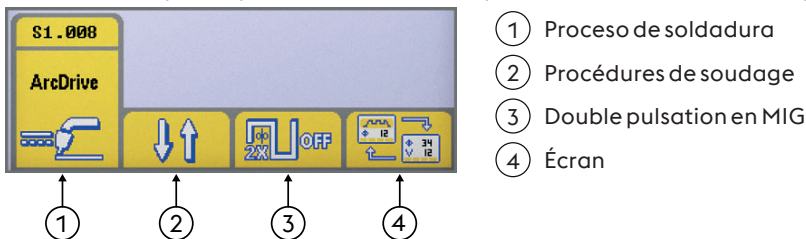

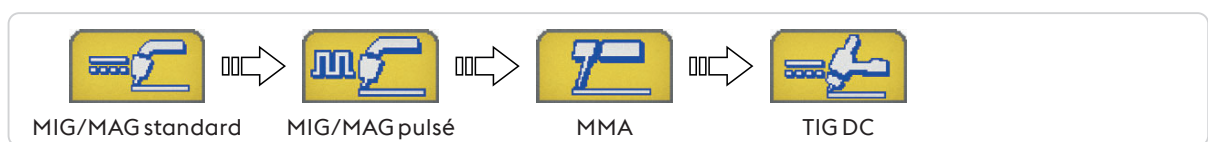

Proceso de soldadura



Procédures de soudage

Permet la sélection du mode de soudage

- 
2 Temps
 En mode 2 temps, une pression sur la gâchette libère le gaz, alimente la tension du fil et active son dévidage;
 relâcher la gâchette stoppe le gaz, la tension et le dévidage du fil.
- 
4 Temps
 En mode 4 temps, une première pression sur la gâchette libère le gaz pendant le temps de pré-gaz manuel. Relâcher la gâchette active la tension du fil et son dévidage. La pression suivante stoppe l'avance fil et active le dernier processus qui ramène l'intensité à zéro. Relâcher la gâchette provoque l'arrêt de l'alimentation du gaz.
- 
Evanouissement (anti-crater)
 Permet au soudeur le contrôle et l'accès direct par la gâchette à 3 niveaux de soudage.
 Une première pression libère le gaz, alimente la tension du fil qui active son dévidage à une vitesse pré-réglée dans les paramètres initiaux et selon des valeurs synergiques relatives aux paramètres de soudage.
 Relâcher la gâchette permet à la vitesse de fil et aux paramètres synergiques relatifs de revenir automatiquement aux valeurs de départ enregistrées sur le panneau de commande.
 Une nouvelle pression sur la gâchette permet à la vitesse de fil et aux paramètres synergiques relatifs de retrouver les valeurs de paramètres d'anti-cratère pré-réglés durant la préparation.
 Relâcher la gâchette provoque l'arrêt du dévidage du fil et enclenche le burn back (retour de fil) et le temps de post-gaz.

Double pulsation en MIG

Double pulsation actif

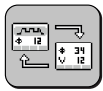

Double pulsation non actif

Écran

Permet de changer l'affichage entre :



Écran de base







Écran graphique

Écran de courbes synergiques

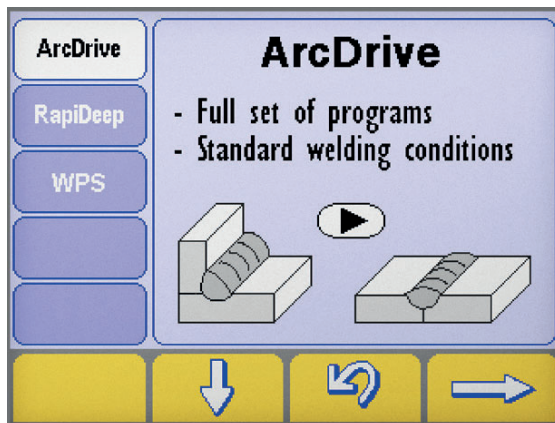
Synergie

Permet la sélection d'un programme de soudage préselectionné (synergie) en choisissant quelques réglages simples

Sélection du procédé de soudage

- ▶ Entrer dans l'écran « synergies » en appuyant sur la touche  pendant au moins une seconde.
- ▶ Sélectionner le procédé souhaité en appuyant sur les touches  et 
- ▶ Appuyer sur le bouton  pour passer à l'étape suivante.

FR

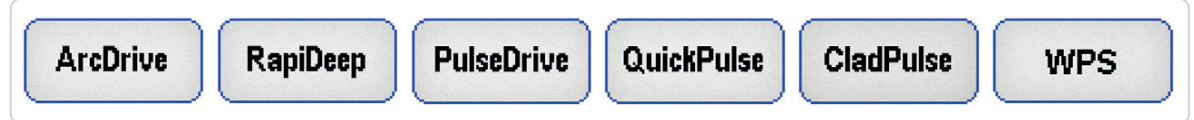
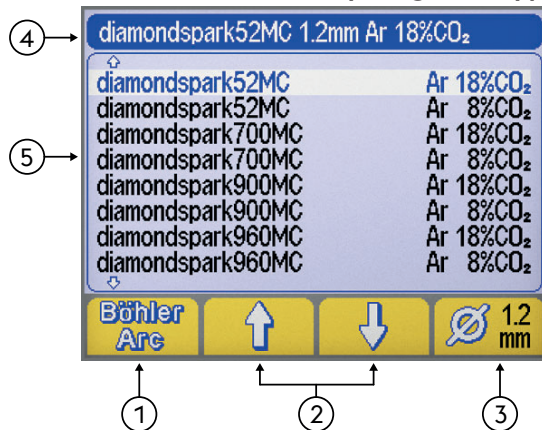
Proceso de soldadura

Écran de sélection de la synergie du type de matériau/gaz

- ① Programme de soudage (BöhlerArc/UniversalArc)
- ② Sélection du matériau/gaz
- ③ Diamètre de fil
- ④ En-tête
- ⑤ Programme de soudage

Programme de soudage

Permet la sélection du programme de soudage



BöhlerArc



UniversalArc

Sélection du matériau/gaz

Permet de régler:



- Type de métal d'apport
- Type de gaz



Diamètre de fil

Permet la sélection du diamètre de fil utilisé (mm).

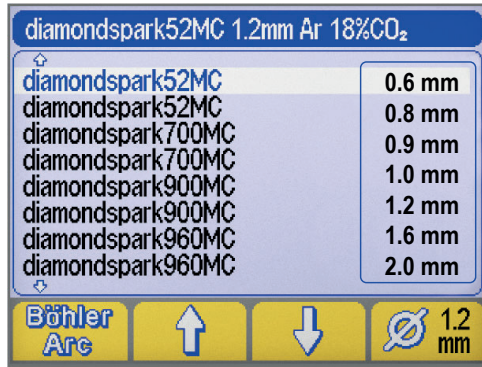

① Diamètre de fil

①

FR



En-tête

Permet l'affichage de certaines informations importantes relatives au procédé sélectionné.



PAS DE PROGRAMME

Indique que le programme de synergie sélectionné n'est pas disponible ou n'est pas compatible avec les réglages de l'autre installation.

4.7 Ecran de programmes



Permet l'enregistrement et la gestion de 240 programmes de soudage qui peuvent être personnalisés par l'opérateur.

Programmes (JOB)

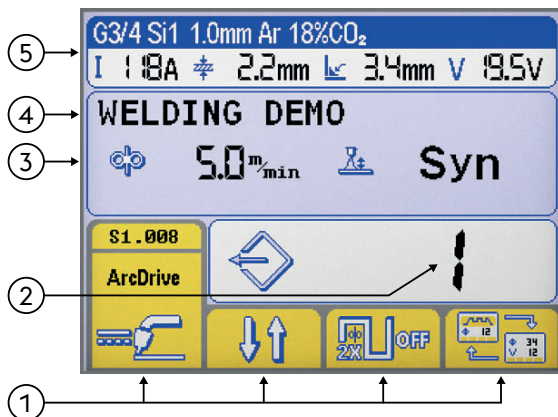

- ① Fonctions
- ② Numéro du programme sélectionné
- ③ Principaux paramètres du programme sélectionné
- ④ Description of du programme sélectionné
- ⑤ En-tête

Consulter la section "Ecran principal"

Programmation

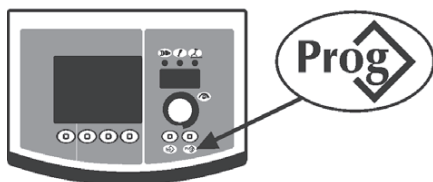

▶ Entrer dans le menu « program storage » (enregistrement programme) par une pression sur la touche. pendant au moins une seconde.



▶ Sélectionner le programme choisi (ou la mémoire vide) en tournant le potentiomètre.

--- **Mémoire vide**



Programme enregistré

▶ Annuler l'opération par une pression sur la touche .

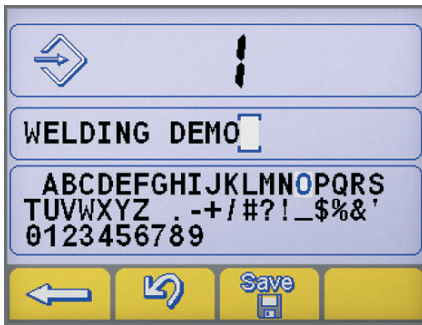
▶ Enregistrer tous les réglages sur le programme sélectionné par une pression sur la touche. .





Inscrire la description du programme.

- ▶ Sélectionner la lettre souhaitée en tournant le potentiomètre.
- ▶ Enregistrer la lettre sélectionnée par une pression sur le bouton de réglage.
- ▶ Supprimer la dernière lettre par une pression sur la touche. .
- ▶ Annuler l'opération par une pression sur la touche .
- ▶ Confirmer l'opération par une pression sur la touche .





L'enregistrement d'un nouveau programme sur une position de mémoire déjà occupée nécessite la suppression de la position de la mémoire par une procédure obligatoire.

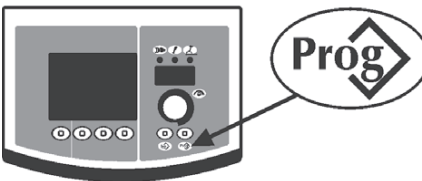

- ▶ Annuler l'opération par une pression sur la touche .
- ▶ Déprogrammer le programme sélectionné par une pression sur la touche. .
- ▶ Reprendre la procédure d'enregistrement.

Rappel de programme





- ▶ Récupérer le 1er programme disponible par une pression sur la touche .
- ▶ Sélectionner le programme souhaité en tournant le potentiomètre.
- ▶ Sélectionner le programme désiré par une pression sur la touche. .





Seules les positions de mémoires occupées par un programme sont retrouvées, les programmes vides seront automatiquement sautés.

Annulation d'un programme



- ▶ Sélectionner le programme souhaité en tournant le potentiomètre.
- ▶ Déprogrammer le programme sélectionné par une pression sur la touche. .
- ▶ Annuler l'opération par une pression sur la touche .



- ▶ Annuler l'opération par une pression sur la touche .
- ▶ Déprogrammer le programme sélectionné par une pression sur la touche. .

5. MENU SET UP

5.1 Set up et paramétrage des paramètres

Il permet de saisir et de régler toute une série de paramètres supplémentaires pour une gestion plus précise du système de soudage.

Les paramètres présents dans le menu set up sont organisés en fonction du processus de soudage sélectionné et possèdent un code numérique.

Entrée dans le menu set up



- ▶ Il suffit d'appuyer pendant 5 s sur potentiomètre
- ▶ L'entrée sera confirmée par la mention 0 sur l'écran.

FR

Sélection et réglage du paramètre désiré

- ▶ Tourner le potentiomètre pour afficher le code numérique relatif au paramètre désiré.
- ▶ Le fait d'appuyer sur le potentiomètre permet alors d'afficher la valeur saisie pour le paramètre sélectionné et le réglage correspondant.

Sortie du menu set up

- ▶ Appuyer de nouveau sur le potentiomètre pour quitter la section "réglage".
- ▶ Se placer sur le paramètre "0" (memoriser et quitter) et appuyer sur potentiomètre pour quitter le menu set up.
- ▶ Annuler l'opération par une pression sur la touche
- ▶ Pour enregistrer la modification et quitter la configuration, appuyez sur la touche:

5.1.1 Liste des paramètres du menu set up (MMA)

0

Mémoriser et quitter

Cette touche permet de mémoriser les modifications et de quitter le menu set up.



1

Réinitialisation (reset)

Cette touche permet de ramener tous les paramètres à la valeur par défaut.



3

Surintensité à l'amorçage

Il permet de régler la valeur de hot start en MMA.

Permet d'avoir un démarrage plus ou moins "chaud" durant les phases d'amorçage de l'arc, ce qui facilite en fait les opérations de démarrage.



Électrode basique

Minimum	Maximum	Réglage par défaut
0/off	500%	80%

Électrode cellulosique

Minimum	Maximum	Réglage par défaut
0/off	500%	150%

Électrode CrNi

Minimum	Maximum	Réglage par défaut
0/off	500%	100%

Électrode aluminium

Minimum	Maximum	Réglage par défaut
0/off	500%	120%

Électrode de fonte

Minimum	Maximum	Réglage par défaut
0/off	500%	100%

7 Courant de soudage



Il permet de régler le courant de soudage.

Minimum	Maximum	Réglage par défaut
3 A	I _{max}	100 A

8 Arc force



Il permet de régler la valeur de l'Arc force en MMA.

Permet d'avoir une réponse dynamique plus ou moins énergétique durant le soudage, ce qui facilite en fait le travail du soudeur.

Augmenter la valeur de l'arc force pour réduire les risques de collage de l'électrode.

Électrode basique

Minimum	Maximum	Réglage par défaut
0/off	500%	30%

Électrode cellulosique

Minimum	Maximum	Réglage par défaut
0/off	500%	350%

Électrode CrNi

Minimum	Maximum	Réglage par défaut
0/off	500%	30%

Électrode aluminium

Minimum	Maximum	Réglage par défaut
0/off	500%	100%

Électrode de fonte

Minimum	Maximum	Réglage par défaut
0/off	500%	70%

204 Dynamic power control (DPC)

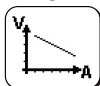

Permet aux caractéristiques V/I choisies d'être sélectionnées.

I=C Courant constant

L'augmentation ou la diminution de la hauteur d'arc n'a aucun effet sur le courant de soudage exigé.

Recommandé pour l'électrode: Basique, Rutile, Acide, Acier, Fonte

1:20 Diminution du gradient de contrôle

L'augmentation de la hauteur d'arc entraîne une baisse du courant de soudage (et vice versa) selon une valeur imposée de 1 à 20 Amps par volt.

Recommandé pour l'électrode: Cellulosique, Aluminium

P=C Puissance constante

L'augmentation de la hauteur d'arc entraîne une baisse du courant de soudage (et vice versa) selon la règle: $V \cdot I = K$

Recommandé pour l'électrode: Cellulosique, Aluminium

312 Tension de coupure de l'arc



Pour saisir la valeur de tension à laquelle l'arc électrique est obligé de s'éteindre.

Cette fonction permet de gérer les différentes conditions de fonctionnement qui se présentent.

Durant la phase de soudure point par point par exemple, une basse tension de coupure de l'arc réduit le réamorçage de l'arc lorsque l'on éloigne l'électrode de la pièce, réduisant ainsi les projections, les brûlures et l'oxydation de cette dernière.

S'il faut utiliser des électrodes qui demandent une haute tension, il est au contraire conseillé de saisir un seuil haut pour éviter que l'arc ne s'éteigne durant le soudage.



Ne jamais saisir une tension de coupure d'arc supérieure à la tension à vide du générateur.

Électrode basique

Minimum	Maximum	Réglage par défaut
0/off	99.9 V	57.0 V

Électrode cellulosique

Minimum	Maximum	Réglage par défaut
0/off	99.9 V	70.0 V

399 Vitesse de découpage



Permet de régler la vitesse de soudage.

Default cm/min: vitesse de référence en soudage manuel.

Syn: valeur sinergique.

Minimum	Maximum	Réglage par défaut
1 cm/min	200 cm/min	15 cm/min

500 Configuration de la machine



Permet la sélection de l'interface graphique exigée.
Permet l'accès aux niveaux les plus hauts du set-up (sélection).
Consulter le paragraphe "Personnalisation d'interface (Set up 500)"

Valor	Interface Utilisateur
XE	Mode Simple
XA	Mode Avancé
XP	Mode Expert

Valor	Niveau sélectionné
USER	Utilisateur
SERV	Service
vaBW	vaBW

551 Lock/unlock



Permet le blocage d'accès au panneau de commandes et la possibilité d'insérer un code de protection.
Consulter le paragraphe "Lock/unlock (Set up 551)".

552 Tonalité du vibreur sonore



Pour régler la tonalité du vibreur sonore.

Minimum	Maximum	Réglage par défaut
0/off	10	10

601 Réglage graduel



Permet le réglage graduel d'un paramètre qui peut être personnalisé par l'opérateur.

Minimum	Maximum	Réglage par défaut
1	Imax	1

602 Paramètre externe CH1, CH2, CH3, CH4



Permet la gestion du paramètre externe 1, 2, 3, 4 (valeur minimum, valeur maximum, valeur par défaut, paramètre sélectionné).
Consulter le paragraphe "Gestion des commandes externes (Set up 602)".

705 Calibration de résistance du circuit



Permet l'étalonnage du système.
Consulter le paragraphe "Calibration de résistance du circuit (set up 705)".

751 Lecture du courant



Permet l'affichage de la valeur réelle du courant de soudage.

752 Lecture de la tension



Permet l'affichage de la valeur réelle de la tension de soudage.

768 Mesure de l'apport de chaleur HI



Permet de lire la valeur de la mesure de l'apport thermique en soudage.

5.1.2 Liste des paramètres de configuration (TIG)

0 Mémoriser et quitter



Cette touche permet de mémoriser les modifications et de quitter le menu set up.

1 Réinitialisation (reset)



Cette touche permet de ramener tous les paramètres à la valeur par défaut.

7
Courant de soudage

Il permet de régler le courant de soudage.

Minimum	Maximum	Réglage par défaut
3 A	I _{max}	100 A

399
Vitesse de découpage

Permet de régler la vitesse de soudage.

Default cm/min: vitesse de référence en soudage manuel.

Syn: valeur sinergique.

Minimum	Maximum	Réglage par défaut
1 cm/min	200 cm/min	10 cm/min

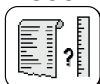
500
Configuration de la machine

Permet la sélection de l'interface graphique exigée.

Permet l'accès aux niveaux les plus hauts du set-up (sélection).

Consulter le paragraphe "Personnalisation d'interface (Set up 500)"

Valor	Interface Utilisateur	Valor	Niveau sélectionné
XE	Mode Simple	USER	Utilisateur
XA	Mode Avancé	SERV	Service
XP	Mode Expert	vaBW	vaBW

551
Lock/unlock

Permet le blocage d'accès au panneau de commandes et la possibilité d'insérer un code de protection.

Consulter le paragraphe "Lock/unlock (Set up 551)".

552
Tonalité du vibreur sonore

Pour régler la tonalité du vibreur sonore.

Minimum	Maximum	Réglage par défaut
0/off	10	10

601
Réglage graduel

Permet le réglage graduel d'un paramètre qui peut être personnalisé par l'opérateur.

Minimum	Maximum	Réglage par défaut
1	I _{max}	1

602
Paramètre externe CH1, CH2, CH3, CH4

Permet la gestion du paramètre externe 1, 2, 3, 4 (valeur minimum, valeur maximum, valeur par défaut, paramètre sélectionné).

Consulter le paragraphe "Gestion des commandes externes (Set up 602)".

705
Calibration de résistance du circuit

Permet l'étalonnage du système.

Consulter le paragraphe "Calibration de résistance du circuit (set up 705)".

751
Lecture du courant

Permet l'affichage de la valeur réelle du courant de soudage.

752
Lecture de la tension

Permet l'affichage de la valeur réelle de la tension de soudage.

FR

FR

755 **Lecture du débit gaz (WFR)**
 Permet l'affichage de la valeur réelle du débit gaz.

757 **Lecture vitesse fil**
 Lecture encodeur moteur 1.

760 **Lecture du courant (moteur 1)**
 Permet l'affichage de la valeur réelle du courant (moteur 1).

764 **Lecture du débit du liquide réfrigérant**
 Permet l'affichage de la valeur du liquide réfrigérant.

765 **Lecture du température du liquide réfrigérant**
 Permet l'affichage de la valeur réelle du température du liquide réfrigérant.

768 **Mesure de l'apport de chaleur HI**
 Permet de lire la valeur de la mesure de l'apport thermique en soudage.

801 **Limites de sécurité**
 Permet la sélection des limites d'avertissement et de sécurité.
 Permet de contrôler le procédé de soudage en mettant des limites de sécurité et d'avertissement sur les principaux paramètres de soudage mesurables.
 Permet le contrôle précis des différentes phases de soudage.
 Consulter le paragraphe "Limites de sécurité (Set up 801)".

5.1.3 Liste des paramètres de configuration (MIG/MAG)

0 **Mémoriser et quitter**
 Cette touche permet de mémoriser les modifications et de quitter le menu set up.

1 **Réinitialisation (reset)**
 Cette touche permet de ramener tous les paramètres à la valeur par défaut.

2 **Synergie**

MIG/MAG standard:
 Permet la sélection du procédé de soudage MIG manuel (Off) ou MIG synergique (6) par l'enregistrement du matériau à souder.

MIG/MAG pulsé:
 Permet la sélection du procédé de soudage MIG synergique (6) par l'enregistrement du matériau à souder.
 Permet la sélection du procédé de soudage CC/CV.

3 **Vitesse du fil**
 Permet le réglage de la vitesse d'avance de fil.

Minimum	Maximum	Réglage par défaut
0.5 m/min	22.0 m/min	-

4 Courant

Il permet de régler le courant de soudage.

Minimum	Maximum
3 A	I _{max}

5 Épaisseur de la pièce

Permet la sélection de l'épaisseur de la pièce à souder.
 Permet le réglage de l'appareil grâce au réglage de la pièce à souder.

6 Cordon d'angle "a"

Permet de régler la profondeur du cordon sur une soudure d'angle.

7 Tension - longueur d'arc

Permet le réglage de la tension d'arc.
 Permet le réglage de la hauteur d'arc pendant le soudage.

Tension élevée = arc long

Tension basse = arc court

Soudage manuel

Minimum	Maximum	Réglage par défaut
5.0 V	55.5 V	5.0 V

10 Pré-gaz

Cette touche permet de sélectionner et de régler l'arrivée du gaz avant l'amorçage de l'arc.
 Elle permet d'alimenter le gaz dans la torche et de préparer la soudure.

Minimum	Maximum	Réglage par défaut
0/off	99.9 s	0.1 s

11 Soft start

Cette touche permet de régler la vitesse d'avancement du fil durant les phases qui précèdent l'amorçage.
 Elle permet un amorçage à vitesse réduite, donc plus doux et avec moins de projections.

Minimum	Maximum	Réglage par défaut
10 %	100 %	50 %

12 Rampe moteur

Cette touche permet une transition graduelle entre la vitesse d'amorçage du fil et la vitesse du fil.

Minimum	Maximum	Réglage par défaut
0/off	1.0 s	0/off

15 Burn back

Cette touche permet de régler le temps de fusion du fil en l'empêchant de coller en fin de soudure.
 Elle permet de régler la longueur de l'extrémité du fil qui dépasse de la torche.

Minimum	Maximum	Réglage par défaut
-2.00	+2.00	0/syn

16 Post gaz

Il permet de régler l'arrivée du gaz en fin de soudage.

Minimum	Maximum	Réglage par défaut
0/off	99.9 s	2.0 s

FR

19 Duty cycle (double pulsé)



Permet le réglage du duty cycle en mode double pulsé.

Minimum	Maximum	Réglage par défaut
10 %	90 %	50 %

20 Double pulsation



Permet le réglage de l'amplitude de pulsation.

Minimum	Maximum	Réglage par défaut
0 %	100 %	±25 %
Minimum	Maximum	Réglage par défaut
0.5 m/min	22 m/min	2.5 m/min

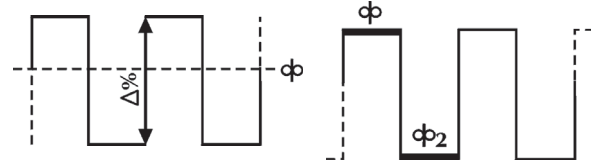

21 Fréquence de pulsation (double pulsé)



Permet le réglage du cycle, par ex. de la période de répétition de la pulsation.

Permet le réglage de la fréquence de pulsation.

Minimum	Maximum	Réglage par défaut
0.1 Hz	5.0 Hz	2.0 Hz

22 Tension secondaire (double pulsé)



Permet le réglage de la tension du niveau de pulsation secondaire.

Permet d'obtenir une plus grande stabilité de l'arc pendant les différentes phases de pulsation.

Minimum	Maximum	Réglage par défaut
-5.0	+5.0	0/syn

23 Rampes de pulsation (double pulsé)



Permet le réglage du temps de pente durant le mode de pulsation.

Minimum	Maximum	Réglage par défaut
1 %	100 %	50 %

24 Bilevel (4T - crater filler)



Il permet de régler la vitesse de fil secondaire dans le mode de soudage bilevel.

En appuyant sur la gachette et puis en la relâchant rapidement, "φ₂" on passe au niveau.

Chaque fois qu'on repète cette opération on change le niveau du courant de "φ" et vice versa.

Minimum	Maximum	Réglage par défaut
1 %	200 %	0/off

25 Montée initiale



Permet le réglage de la valeur de vitesse de fil durant la première phase anti-cratère de soudage.

Permet d'augmenter l'énergie fournie à la pièce pendant la phase durant laquelle la matière, encore froide, nécessite plus de chaleur pour fondre uniformément.

Minimum	Maximum	Réglage par défaut
20 %	200 %	120 %

26 Crater filler



Permet le réglage de la valeur de vitesse de fil pendant la phase de fin de soudage.

Permet de réduire l'énergie fournie à la pièce pendant la phase durant laquelle la matière est déjà très chaude, réduisant ainsi le risque de déformations inutiles.

Minimum	Maximum	Réglage par défaut
20 %	200 %	80 %

27 Temps d'incrément initial



Permet de régler le temps d'incrément initial.
 Permet d'automatiser la fonction "anticratère".

Minimum	Maximum	Réglage par défaut
0.1 s	99.9 s	0/off

28 Temps d'anti-cratère

Permet de régler le temps "anti-cratère".
 Permet d'automatiser la fonction "anticratère".

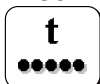
Minimum	Maximum	Réglage par défaut
0.1 s	99.9 s	0/off

30 Soudage par point

Permet l'accès au mode « soudage par point » et le réglage de la durée du point.

Minimum	Maximum	Réglage par défaut
0.1 s	99.9 s	0/off

31 Point d'arrêt

Cette touche permet d'activer le mode "point d'arrêt" et de régler l'intervalle des points entre deux soudures.

Minimum	Maximum	Réglage par défaut
0.1 s	99.9 s	0/off

32 Tension secondaire (Bilevel MIG)

Permet le réglage de la tension du niveau de pulsation secondaire.
 Permet d'obtenir une plus grande stabilité de l'arc pendant les différentes phases de pulsation.

Minimum	Maximum	Réglage par défaut
-5.0	+5.0	0/syn

33 Inductance secondaire (Bilevel MIG)

Permet le réglage de l'inductance du niveau de pulsation secondaire.
 Permet d'obtenir un arc plus ou moins rapide pour compenser les mouvements du soudeur et l'instabilité naturelle de la soudure.

Inductance basse = arc réactif (plus de projections).
 Inductance haute = arc moins réactif (moins de projections).

Minimum	Maximum	Réglage par défaut
-30	+30	0/syn

34 Rampe incrément initial

Permet de régler un passage progressif entre l'incrément initial et le soudage.

Minimum	Maximum	Réglage par défaut
0 s	10 s	0/off

35 Rampe crater filler

Permet de régler un passage progressif entre le soudage et le crater filler.

Minimum	Maximum	Réglage par défaut
0 s	10 s	0/off

FR

202 Inductance



Permet le réglage électronique de l'inductance de série du circuit de soudage.
Permet d'obtenir un arc plus ou moins rapide pour compenser les mouvements du soudeur et l'instabilité naturelle de la soudure.

Inductance basse = arc réactif (plus de projections).
Inductance haute = arc moins réactif (moins de projections).

Minimum	Maximum	Réglage par défaut
-30	+30	0/syn

331 Tension moyenne compensée



Permet de régler la tension de soudage.

399 Vitesse de découpage



Permet de régler la vitesse de soudage.
Default cm/min: vitesse de référence en soudage manuel.
Syn: valeur sinergique.

Minimum	Maximum	Réglage par défaut
syn min	syn max	35 cm/min

500 Configuration de la machine



Permet la sélection de l'interface graphique exigée.
Permet l'accès aux niveaux les plus hauts du set-up (sélection).
Consulter le paragraphe " Personnalisation d'interface (Set up 500)"

Valor	Interface Utilisateur
XE	Mode Simple
XA	Mode Avancé
XP	Mode Expert

Valor	Niveau sélectionné
USER	Utilisateur
SERV	Service
vaBW	vaBW

551 Lock/unlock



Permet le blocage d'accès au panneau de commandes et la possibilité d'insérer un code de protection.
Consulter le paragraphe " Lock/unlock (Set up 551)".

552 Tonalité du vibreur sonore



Pour régler la tonalité du vibreur sonore.

Minimum	Maximum	Réglage par défaut
0/off	10	10

601 Réglage graduel



Permet le réglage graduel d'un paramètre qui peut être personnalisé par l'opérateur.
Fonctionnalité contrôlée par le bouton haut / bas de la torche.

Minimum	Maximum	Réglage par défaut
1	Imax	1

602 Paramètre externe CH1, CH2, CH3, CH4



Permet la gestion du paramètre externe 1, 2, 3, 4 (valeur minimum, valeur maximum, valeur par défaut, paramètre sélectionné).

Consulter le paragraphe "Gestion des commandes externes (Set up 602)".

606 Torche U/D

Permet la gestion du paramètre externe (U/D).

Valor	Réglage par défaut	Fonction de rappel
0/off	-	off
1/I1	X	Courant
	-	Rappel de programme

705 Calibration de résistance du circuit

Permet l'étalonnage du système.

Consulter le paragraphe "Calibration de résistance du circuit (set up 705)".

751 Lecture du courant

Permet l'affichage de la valeur réelle du courant de soudage.

752 Lecture de la tension

Permet l'affichage de la valeur réelle de la tension de soudage.

755 Lecture du débit gaz (WFR)

Permet l'affichage de la valeur réelle du débit gaz.

757 Lecture vitesse fil

Lecture encodeur moteur 1.

758 Vitesse du mouvement robot

Permet l'affichage de la vitesse du mouvement du bras d'un robot ou d'un dispositif d'automatisation.

760 Lecture du courant (moteur 1)

Permet l'affichage de la valeur réelle du courant (moteur 1).

761 Lecture vitesse fil

Lecture encodeur moteur 2.

762 Lecture du courant (moteur 2)

Permet l'affichage de la valeur réelle du courant (moteur 2).

763 Lecture vitesse fil

Lecture réelle de l'avancement du fil.

764 Lecture du débit du liquide réfrigérant

Permet l'affichage de la valeur du liquide réfrigérant.

765 Lecture du température du liquide réfrigérant



Permet l'affichage de la valeur réelle du température du liquide réfrigérant.

768 Mesure de l'apport de chaleur HI



Permet de lire la valeur de la mesure de l'apport thermique en soudage.

801 Limites de sécurité



Permet la sélection des limites d'avertissement et de sécurité.

Permet de contrôler le procédé de soudage en mettant des limites de sécurité et d'avertissement sur les principaux paramètres de soudage mesurables.

Permet le contrôle précis des différentes phases de soudage.

Consulter le paragraphe "Limites de sécurité (Set up 801)".

5.2 Procédures spécifiques d'utilisation des paramètres

5.2.1 Personnalisation de l'écran à 7 segments

Permet d'afficher en permanence la valeur d'un paramètre sur l'écran à 7 segments.

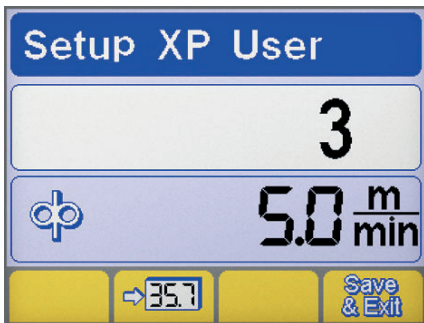

- ▶ Entrer dans le menu de sélection (Set-up) par une pression d'au moins 5 secondes sur le bouton de réglage.
- ▶ Sélectionner le paramètre souhaité en tournant le potentiomètre.
- ▶ Enregistrer le paramètre sélectionné dans l'écran à 7 segments par une pression sur la touche .
- ▶ Sauvegarder et sortir de l'écran en cours par une pression sur la touche .

5.2.2 Personnalisation d'interface (Set up 500)

Permet la personnalisation des paramètres sur le menu principal.

500 Configuration de la machine



Permet la sélection de l'interface graphique exigée.

Valor	Interface Utilisateur
XE	Mode Simple
XA	Mode Avancé
XP	Mode Expert

MODE XE

MMA	
Paramètres de soudage	
TIG	
Paramètres de soudage	
Fonctions	
MIG/MAG	
Paramètres de soudage	
Fonctions	

MODE XA

MMA	
Paramètres de soudage	
Fonctions	
TIG	
Paramètres de soudage	
Fonctions	
MIG/MAG	
Paramètres de soudage	
Fonctions	

FR

MODE XP

MMA	
Paramètres de soudage	
Fonctions	
TIG	
Paramètres de soudage	
Fonctions	
MIG/MAG	
Paramètres de soudage	
Fonctions	

5.2.3 Lock/unlock (Set up 551)

Permet le blocage d'accès au panneau de commandes et la possibilité d'insérer un code de protection.

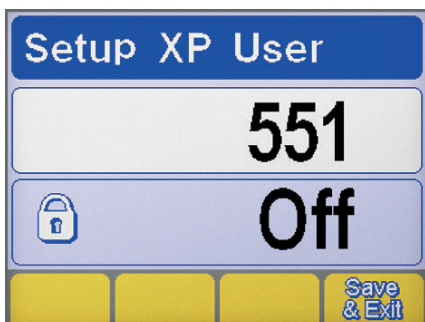

- Sélection du paramètre**
- ▶ Entrer dans le menu de sélection (Set-up) par une pression d'au moins 5 secondes sur le bouton de réglage.
 - ▶ Sélectionner le paramètre désiré (551).
 - ▶ Activer le réglage du paramètre sélectionné par une pression sur le bouton de réglage.

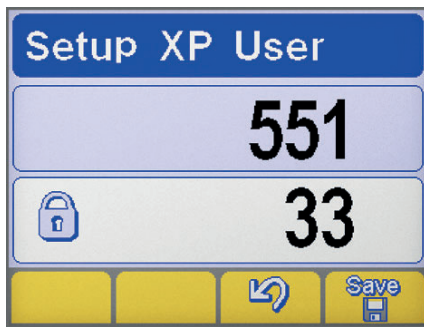

- ▶ Sélectionner un code numérique (mot de passe) en tournant le potentiomètre.
- ▶ Confirmez l'opération en appuyant sur la touche de l'encodeur.
- ▶ Annuler l'opération par une pression sur la touche
- ▶ Pour enregistrer la modification, appuyez sur la touche:

Fonctions du panneau



La poursuite de toute opération sur un panneau de contrôle bloqué fait apparaître un écran spécial.

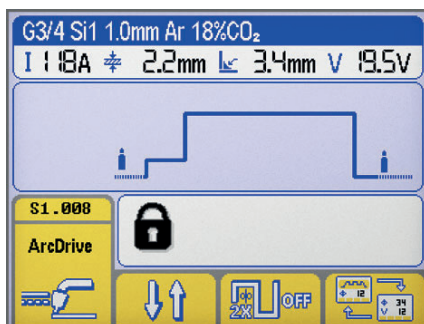

- ▶ Accéder temporairement (5 minutes) aux fonctionnalités du panneau en tournant le potentiomètre et en entrant le mot de passe correct.
- ▶ Confirmez l'opération en appuyant sur la touche de l'encodeur.
- ▶ Déverrouiller définitivement le panneau de commande en entrant dans le menu de sélection (Set-up) (suivre les instructions décrites ci-dessus) et ramener le paramètre 551 en position « off ».
- ▶ Confirmez l'opération en appuyant sur la touche de l'encodeur.
- ▶ Pour enregistrer la modification, appuyez sur la touche:

5.2.4 Gestion des commandes externes (Set up 602)

Permet la gestion du paramètre externe 2 (valeur minimum, valeur maximum, valeur par défaut, paramètre sélectionné).

Sélection du paramètre

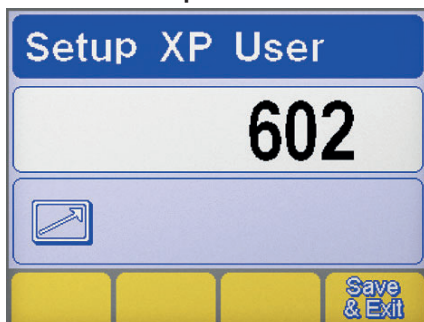

- ▶ Entrer dans le menu de sélection (Set-up) par une pression d'au moins 5 secondes sur le bouton de réglage.
- ▶ Sélectionner le paramètre désiré (602).
- ▶ Entrer dans l'écran de « Gestion des commandes externes » par une pression sur le bouton de réglage.

Gestion des commandes externes

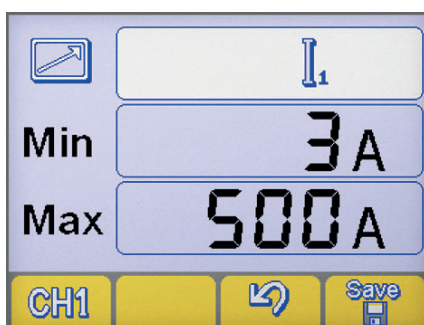

- ▶ Sélectionner la sortie de commande à distance RC désirée (CH1, CH2, CH3, CH4) par une pression sur la touche
- ▶ Sélectionner le paramètre souhaité (Min-Max-parametre) par une pression sur le bouton de réglage.
- ▶ Régler le paramètre souhaité (Min-Max-parametre) en tournant le potentiomètre.
- ▶ Pour enregistrer la modification, appuyez sur la touche:
- ▶ Annuler l'opération par une pression sur la touche

5.2.5 Calibration de résistance du circuit (set up 705)

Permet de calibrer le générateur sur la résistance du circuit de soudage actuel.

Sélection du paramètre

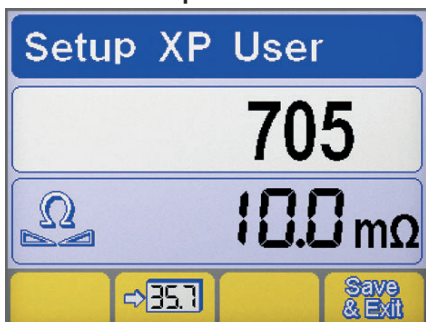

- ▶ Entrer dans le menu de sélection (Set-up) par une pression d'au moins 5 secondes sur le bouton de réglage.
- ▶ Sélectionner le paramètre désiré (705).
- ▶ Activer le réglage du paramètre sélectionné par une pression sur le bouton de réglage.
- ▶ Connectez le générateur au circuit de soudage (banc ou pièce).
- ▶ Retirez le capuchon pour exposer l'extrémité du porte-buse de la torche. (MIG/MAG)

Étalonnage

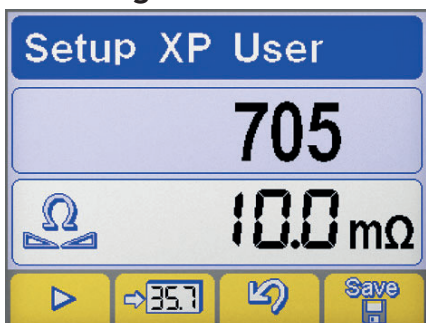

- ▶ Placer la buse guide fil en contact électrique avec la pièce à souder. (MIG/MAG)
- ▶ Appuyez sur la touche pour lancer la procédure.
- ▶ Maintenez le contact pendant au moins une seconde.
- ▶ La valeur affichée sur l'écran sera mise à jour après l'étalonnage.
- ▶ Confirmer l'opération par une pression sur la touche .
- ▶ Annuler l'opération par une pression sur la touche .
- ▶ Pour enregistrer la modification et quitter la configuration, appuyez sur la touche: .

FR

5.2.6 Limites de sécurité (Set up 801)

Permet la sélection des limites d'avertissement et de sécurité.

Permet de contrôler le procédé de soudage en mettant des limites de sécurité et d'avertissement sur les principaux paramètres de soudage mesurables.

Permet le contrôle précis des différentes phases de soudage.

Seuil d'alerte			Limites de sécurité		
Courant de soudage			tension de soudage		
Lecture du débit gaz			Vitesse du mouvement robot		
Lecture du courant (moteur 1)			Lecture du courant (moteur 2)		
Lecture du débit du liquide réfrigérant			Lecture vitesse fil		
Lecture du température du liquide réfrigérant					

Sélection du paramètre

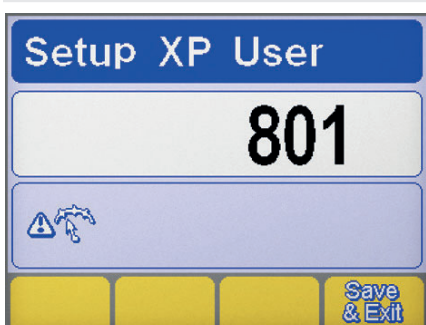

- ▶ Entrer dans le menu de sélection (Set-up) par une pression d'au moins 5 secondes sur le bouton de réglage.
- ▶ Sélectionner le paramètre désiré (801).
- ▶ Entrer sur l'écran « Limites de sécurité » par une pression sur le bouton de réglage.

Sélection du paramètre

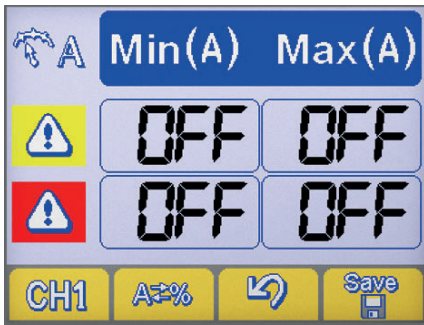

- ▶ Sélectionner le paramètre souhaité par une pression sur la touche **CH1**.
- ▶ Sélectionner le mode de sélection des limites de sécurité par une pression sur la touche **A=V**.

A=V Configuration de la machine

A/V Valeur absolue

% Valeur en pourcentage

FR

Configuration des seuils de protection

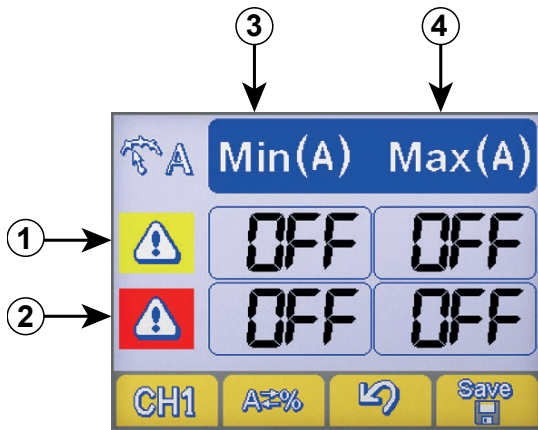

- ① Ligne de limite d'avertissement
- ② Ligne de limites d'alarmes
- ③ Colonne de niveaux minimums
- ④ Colonne de niveaux maximums

- ▶ Sélectionner la case souhaitée par une pression sur le bouton de réglage (la case sélectionnée apparaît en surbrillance).
- ▶ Régler le niveau de la limite sélectionnée en tournant le potentiomètre.
- ▶ Pour enregistrer la modification, appuyez sur la touche: **Save**.



- Dépasser une des limites d'avertissement déclenche un signal visuel sur le panneau de commandes.
- Dépasser une des limites d'alarme déclenche un signal visuel sur le panneau de commandes et le blocage immédiat des opérations de soudage.
- Il est possible de mettre des filtres de début et de fin de soudure afin d'éviter des messages d'erreur durant l'amorçage et l'extinction de l'arc (consulter le paragraphe « Set up » - Paramètres 802-803-804).

6. ENTRETIEN



Effectuer l'entretien courant de l'installation selon les indications du constructeur. Toutes les portes d'accès et de service et les couvercles doivent être fermés et bien fixés lorsque l'appareil est en marche. L'installation ne doit absolument pas être modifiée. Eviter l'accumulation de poussière métallique à proximité et sur les grilles d'aération.



Toute opération éventuelle de maintenance doit exclusivement être effectuée par du personnel qualifié. La réparation ou le remplacement de pièces de la part de personnel non autorisé implique l'annulation immédiate de la garantie du produit. La réparation ou le remplacement de pièces doit exclusivement être effectué par du personnel technique qualifié.



Couper l'alimentation électrique de l'installation avant toute intervention!

6.1 Contrôles périodiques sur le générateur

6.1.1 Système



Effectuer le nettoyage interne avec de l'air comprimé à basse pression et des brosses souples. Contrôler les connexions électriques et tous les câbles de branchement.

6.1.2 Pour la maintenance ou le remplacement des composants des torches, de la pince porte-électrode et/ou des câbles de masse:



Contrôler la température des composants et s'assurer qu'ils ne sont pas trop chauds.



Toujours porter des gants conformes aux normes.



Utiliser des clefs et des outils adéquats.

6.2 Responsabilité



Le constructeur décline toute responsabilité si l'opérateur ne respecte pas ces instructions. Le constructeur décline toute responsabilité si l'opérateur ne respecte pas ces instructions. En cas de doute et/ou de problème, n'hésitez pas à consulter le dépanneur agréé le plus proche.

7. CODES D'ALARMES



ALARME

L'intervention d'une alarme ou le dépassement d'un seuil critique de protection entraîne une signalisation visuelle sur le panneau de commande et le blocage immédiat des opérations de soudage.















ATTENTION

L'intervention d'une alarme ou le dépassement d'un seuil critique de protection entraîne une signalisation visuelle sur le panneau de commande et le blocage immédiat des opérations de soudage.

Ci-dessous figure la liste de toutes les alarmes et de tous les seuils critiques de protection du système.

E01	Surtempérature		E02	Surtempérature	
E03	Surtempérature		E05	Surintensité	
E06	Surintensité du module de puissance (Boost)		E07	Défaut du système d'alimentation du moteur du dévidoir	
E08	Moteur bloqué		E10	Surintensité du module de puissance (Inverter)	
E11	Erreur de configuration du système		E12	Erreur de communication (WF - DSP)	
E13	Erreur de communication		E14	Programme non valide	
E15	Programme non valide		E16	Erreur de communication (RI) (automatisation et robotique)	

 E17	Erreur de communication (μ P-DSP)		 E18	Programme non valide	
 E19	Erreur de configuration du système		 E20	Mémoire défectueuse	
 E21	Perte de données		 E22	Erreur de communication (DSP)	
 E29	Mesures incompatibles		 E30	Erreur de communication (H.F.)	
 E32	Perte de données		 E38	Sous-tension	
 E39	Défaut d'alimentation du système		 E40	Défaut d'alimentation du système	
 E43	Liquide de refroidissement manquant		 E48	Fil manquant (automatisation et robotique)	
 E49	Interrupteur d'urgence (automatisation et robotique)		 E50	Fil collé (automatisation et robotique)	
 E51	Paramètres non pris en charge (automatisation et robotique)		 E52	Anti-collision (automatisation et robotique)	
 E53	Erreur de fluxostat externe (automatisation et robotique)		 E54	Niveau de courant dépassé (Limite inférieure)	
 E55	Niveau de courant dépassé (Limite supérieure)		 E56	Niveau de tension dépassé (Limite inférieure)	
 E57	Niveau de tension dépassé (Limite supérieure)		 E60	Limite de vitesse dépassée (Limite inférieure)	
 E61	Limite de vitesse dépassée (Limite supérieure)		 E62	Niveau de courant dépassé (Limite inférieure)	
 E63	Niveau de courant dépassé (Limite supérieure)		 E64	Niveau de tension dépassé (Limite inférieure)	
 E65	Niveau de tension dépassé (Limite supérieure)		 E68	Limite de vitesse dépassée (Limite inférieure)	
 E69	Limite de vitesse dépassée (Limite supérieure)		 E70	Seuils de protection définis incompatibles	
 E71	Surchauffe liquide de refroidissement		 E72	Surintensité du moteur push-pull	

 E73	Limite de vitesse du fil dépassée (speed meter)	
 E74	Niveau de courant moteur 1 dépassé	
 E75	Niveau de courant moteur 2 dépassé	
 E76	Niveau de débit du liquide de refroidissement dépassé	
 E77	Niveau de température du liquide de refroidissement	
 E78	Maintenance active (automatisation et robotique)	

8. DIAGNOSTIC ET SOLUTIONS

L'installation ne s'allume pas (le voyant vert est éteint)

Cause	Solution
» Pas de tension de réseau au niveau de la prise d'alimentation.	» Effectuer une vérification et procéder à la réparation de l'installation électrique. » S'adresser à un personnel spécialisé.
» Connecteur ou câble d'alimentation défectueux.	» Remplacer le composant endommagé. » S'adresser service après-vente le plus proche pour la réparation de l'installation.
» Fusible grillé.	» Remplacer le composant endommagé.
» Interrupteur marche/arrêt défectueux.	» Remplacer le composant endommagé. » S'adresser service après-vente le plus proche pour la réparation de l'installation.
» Connexion entre le dévidoir et le générateur incorrect ou défectueux.	» Vérifier que les différentes parties du système sont correctement connectées.
» Installation électronique défectueuse.	» S'adresser service après-vente le plus proche pour la réparation de l'installation.

Absence de puissance à la sortie (l'installation ne soude pas)

Cause	Solution
» Gâchette de torche défectueux.	» Remplacer le composant endommagé. » S'adresser service après-vente le plus proche pour la réparation de l'installation.
» Installation a surchauffé (défaut thermique - voyant jaune allumé).	» Attendre que le système refroidisse sans éteindre l'installation.
» Panneau latéral ouvert ou contact de la porte défectueux.	» Pour la sécurité de l'opérateur, le panneau latéral doit être fermé pendant les phases de soudage. » Remplacer le composant endommagé. » S'adresser service après-vente le plus proche pour la réparation de l'installation.
» Connexion à la masse incorrecte.	» Procéder à la connexion correcte à la masse. » Consulter le paragraphe "Mise en service".
» Tension de réseau hors plage (voyant jaune allumé).	» Ramener la tension de réseau dans la plage d'alimentation du générateur » Effectuer le raccordement correct de l'installation. » Consulter le paragraphe "Raccordement".
» Installation électronique défectueuse.	» S'adresser service après-vente le plus proche pour la réparation de l'installation.

Courant de sortie incorrect

Cause	Solution
» Sélection erronée du mode de soudage ou sélecteur défectueux.	» Procéder à la sélection correcte du mode de soudage. » Remplacer le composant endommagé. » S'adresser service après-vente le plus proche pour la réparation de l'installation.

» Réglages erronés des paramètres et des fonctions de l'installation.	» Réinitialiser l'installation et régler de nouveau les paramètres de soudage.
» Potentiomètre d'interface du réglage du courant de soudage défectueux.	» Remplacer le composant endommagé. » S'adresser service après-vente le plus proche pour la réparation de l'installation.
» Tension de réseau hors plage.	» Effectuer le raccordement correct de l'installation. » Consulter le paragraphe "Raccordement".
» Phase manquante.	» Effectuer le raccordement correct de l'installation. » Consulter le paragraphe "Raccordement".
» Installation électronique défectueuse.	» S'adresser service après-vente le plus proche pour la réparation de l'installation.

Dévidage du fil bloqué

Cause	Solution
» Gâchette de torche défectueux.	» Remplacer le composant endommagé. » S'adresser service après-vente le plus proche pour la réparation de l'installation.
» Galets non adaptés ou usés.	» Remplacer les galets.
» Moto réducteur défectueux.	» Remplacer le composant endommagé. » S'adresser service après-vente le plus proche pour la réparation de l'installation.
» Gaine de la torche endommagée.	» Remplacer le composant endommagé. » S'adresser service après-vente le plus proche pour la réparation de l'installation.
» Dévidoir non alimenté	» Vérifier la connexion au générateur. » Consulter le paragraphe "Raccordement". » S'adresser service après-vente le plus proche pour la réparation de l'installation.
» Enroulement du fil sur la bobine irrégulier.	» Réajuster le fil ou remplacer la bobine.
» Buse de la torche a fondu (le fil colle)	» Remplacer le composant endommagé.

Dévidage du fil irrégulier

Cause	Solution
» Gâchette de torche défectueux.	» Remplacer le composant endommagé. » S'adresser service après-vente le plus proche pour la réparation de l'installation.
» Galets non adaptés ou usés.	» Remplacer les galets.
» Moto réducteur défectueux.	» Remplacer le composant endommagé. » S'adresser service après-vente le plus proche pour la réparation de l'installation.
» Gaine de la torche endommagée.	» Remplacer le composant endommagé. » S'adresser service après-vente le plus proche pour la réparation de l'installation.
» Embayage d'axe dur ou dispositifs de blocage des galets mal réglés.	» Desserrer levier de frein. » Augmenter la pression sur les galets.

Instabilité de l'arc

Cause	Solution
» Gaz de protection insuffisant.	» Régler le débit de gaz. » Vérifier le bon état de la buse et du diffuseur gaz de la torche.
» Présence d'humidité dans le gaz de soudage.	» Toujours utiliser des produits et des matériaux de qualité. » Veiller à maintenir l'installation d'alimentation du gaz en parfaites conditions.
» Paramètres de soudage incorrects.	» Effectuer un contrôle de l'installation de soudage. » S'adresser service après-vente le plus proche pour la réparation de l'installation.

Projections excessives
Cause

- » Longueur de l'arc incorrecte.

- » Paramètres de soudage incorrects.

- » Gaz de protection insuffisant.

- » Dynamique d'arc incorrecte.

- » Mode de soudage incorrect.

Solution

- » Réduire la distance entre l'électrode et la pièce.

- » Réduire la tension de soudage.

- » Réduire la tension de soudage.

- » Régler le débit de gaz.

- » Vérifier le bon état de la buse et du diffuseur gaz de la torche.

- » Changer la masse de place sur une valeur supérieure.

- » Utilisez une prise inductive plus grande.

- » Réduire l'inclinaison de la torche.

Pénétration insuffisante
Cause

- » Mode de soudage incorrect.

- » Paramètres de soudage incorrects.

- » Electrode inadaptée.

- » Préparation incorrecte des bords.

- » Connexion à la masse incorrecte.

- » Dimension des pièces à souder trop importante.

Solution

- » Réduire la vitesse de progression du soudage.

- » Augmenter l'intensité de soudage.

- » Utiliser une électrode de diamètre inférieur.

- » Augmenter le chanfrein.

- » Procéder à la connexion correcte à la masse.

- » Consulter le paragraphe "Mise en service".

- » Augmenter l'intensité de soudage.

Inclusions de scories
Cause

- » Encrassement.

- » Diamètre de l'électrode trop gros.

- » Préparation incorrecte des bords.

- » Mode de soudage incorrect.

Solution

- » Effectuer un nettoyage des pièces avant d'effectuer le soudage.

- » Utiliser une électrode de diamètre inférieur.

- » Augmenter le chanfrein.

- » Réduire la distance entre l'électrode et la pièce.

- » Avancer régulièrement pendant toutes les phases de soudage.

Inclusions de tungstène
Cause

- » Paramètres de soudage incorrects.

- » Electrode inadaptée.

- » Mode de soudage incorrect.

Solution

- » Réduire la tension de soudage.

- » Utiliser une électrode de diamètre supérieur.

- » Toujours utiliser des produits et des matériaux de qualité.

- » Affûter correctement l'électrode.

- » Eviter les contacts entre l'électrode et le bain de soudure.

Soufflures
Cause

- » Gaz de protection insuffisant.

Solution

- » Régler le débit de gaz.

- » Vérifier le bon état de la buse et du diffuseur gaz de la torche.

Collages
Cause

- » Longueur de l'arc incorrecte.

- » Paramètres de soudage incorrects.

- » Mode de soudage incorrect.

- » Dimension des pièces à souder trop importante.

- » Dynamique d'arc incorrecte.

Solution

- » Augmenter la distance entre l'électrode et la pièce.

- » Augmenter la tension de soudage.

- » Augmenter l'intensité de soudage.

- » Augmenter la tension de soudage.

- » Augmenter l'inclinaison de la torche.

- » Augmenter l'intensité de soudage.

- » Changer la masse de place sur une valeur supérieure.

- » Utilisez une prise inductive plus grande.

FR

Effondrement du métal

Cause	Solution
» Paramètres de soudage incorrects.	» Réduire la tension de soudage. » Utiliser une électrode de diamètre inférieur.
» Longueur de l'arc incorrecte.	» Réduire la distance entre l'électrode et la pièce. » Réduire la tension de soudage.
» Mode de soudage incorrect.	» Réduire la vitesse d'oscillation latérale de remplissage. » Réduire la vitesse de progression du soudage.
» Gaz de protection insuffisant.	» Utiliser des gaz adaptés aux matériaux à souder.

Oxydations

Cause	Solution
» Gaz de protection insuffisant.	» Régler le débit de gaz. » Vérifier le bon état de la buse et du diffuseur gaz de la torche.

Porosité

Cause	Solution
» Présence de graisse, de peinture, de rouille ou de saleté sur les pièces à souder.	» Effectuer un nettoyage des pièces avant d'effectuer le soudage.
» Présence de graisse, de peinture, de rouille ou de saleté sur métal d'apport.	» Toujours utiliser des produits et des matériaux de qualité. » Toujours conserver le d'apport en parfaites conditions.
» Présence d'humidité dans le métal d'apport.	» Toujours utiliser des produits et des matériaux de qualité. » Toujours conserver le d'apport en parfaites conditions.
» Longueur de l'arc incorrecte.	» Réduire la distance entre l'électrode et la pièce. » Réduire la tension de soudage.
» Présence d'humidité dans le gaz de soudage.	» Toujours utiliser des produits et des matériaux de qualité. » Veiller à maintenir l'installation d'alimentation du gaz en parfaites conditions.
» Gaz de protection insuffisant.	» Régler le débit de gaz. » Vérifier le bon état de la buse et du diffuseur gaz de la torche.
» Solidification du bain de soudure trop rapide.	» Réduire la vitesse de progression du soudage. » Préchauffer les pièces à souder. » Augmenter l'intensité de soudage.

Faissures chaudes

Cause	Solution
» Paramètres de soudage incorrects.	» Réduire la tension de soudage. » Utiliser une électrode de diamètre inférieur.
» Présence de graisse, de peinture, de rouille ou de saleté sur les pièces à souder.	» Effectuer un nettoyage des pièces avant d'effectuer le soudage.
» Présence de graisse, de peinture, de rouille ou de saleté sur métal d'apport.	» Toujours utiliser des produits et des matériaux de qualité. » Toujours conserver le d'apport en parfaites conditions.
» Mode de soudage incorrect.	» Suivre les étapes correctes pour le type de joint à souder.
» Pièces à souder présentant des caractéristiques différentes.	» Effectuer un beurrage avant de procéder au soudage.

Faissures froides

Cause	Solution
» Présence d'humidité dans le métal d'apport.	» Toujours utiliser des produits et des matériaux de qualité. » Toujours conserver le d'apport en parfaites conditions.
» Géométrie spéciale du joint à souder.	» Préchauffer les pièces à souder. » Effectuer un post-chauffage. » Suivre les étapes correctes pour le type de joint à souder.

9. INFORMATIONS GENERALES SUR LE SOUDAGE

9.1 Soudage à l'électrode enrobée (MMA)

Préparation des bords

Pour obtenir une bonne soudure, il est toujours conseillé de travailler sur des pièces propres, sans oxydation, ni rouille ou autre agent contaminant.

Choix de l'électrode

Le diamètre de l'électrode à utiliser dépend de l'épaisseur de la pièce, de la position, du type de joint et du type de préparation de la pièce à souder. Les électrodes de gros diamètre ont besoin d'intensité et de températures plus élevées pendant le soudage.

Type d'enrobage	Propriétés	Utilisation
Rutile	Facilité d'emploi	Toutes positions
Acide	Vitesse de fusion élevée	Plat
Basique	Caract. mécaniques	Toutes positions

Choix du courant de soudage

La gamme du courant de soudage relative au type d'électrode utilisé est spécifiée sur le boîtier des électrodes.

Amorçage et maintien de l'arc

On amorce l'arc électrique en frottant la pointe de l'électrode sur la pièce à souder connectée à un câble de masse, et une fois que l'arc a jailli, retirer la baguette rapidement jusqu'à la distance de soudage normale.

En général une surintensité de l'intensité par rapport l'intensité initiale du soudage (Hot-Start) est utile pour améliorer l'amorçage de l'arc. Après l'amorçage de l'arc, la fusion de la partie centrale de l'électrode commence; celle-ci se dépose sur la pièce à souder sous forme de gouttes. L'enrobage extérieur de l'électrode consommée fournit le gaz de protection pour la soudure, assurant ainsi une bonne qualité de soudure. Pour éviter que les gouttes fondues éteignent l'arc en court-circuitant et collant l'électrode sur le cordon, par un rapprochement accidentel entre les deux éléments, une augmentation momentanée de l'intensité de soudage est produite jusqu'à la fin du court-circuit (Arc Force). Réduire le courant de court-circuit au minimum (anti-collage) si l'électrode reste collée à la pièce à souder.

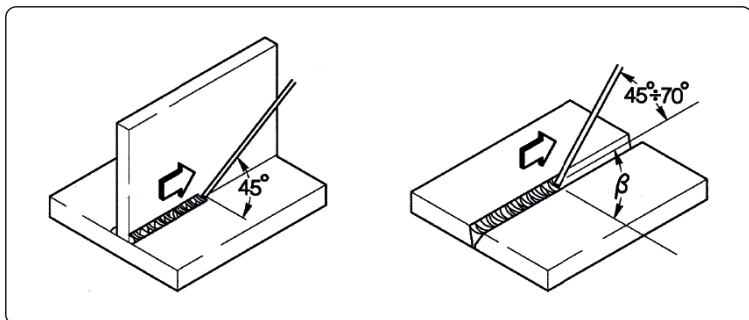

Exécution de la soudure

L'angle d'inclinaison de l'électrode varie en fonction du nombre de passes, le mouvement de l'électrode est normalement exécuté par oscillations et arrêts sur les bords du cordon de façon à éviter une accumulation excessive de dépôt au centre.

Nettoyage des scories

Le soudage par électrodes enrobées implique obligatoirement le prélèvement des scories après chaque passe. Le nettoyage se fait à l'aide d'un petit marteau ou d'une brosse métallique en cas de scories friables.

9.2 Soudage TIG (arc en soudure continue)

Description

Les principes du mode de soudage TIG (Tungsten Inert Gas) est basé sur un arc électrique qui jaillit entre une électrode infusible (tungstène pur ou alliage, température de fusion à environ 3370°C) et la pièce. Une atmosphère de gaz inerte (argon) protège le bain. Afin d'éviter des inclusions de tungstène dangereuses dans la soudure, l'électrode ne doit jamais toucher la pièce à souder, et c'est pour cela qu'on génère une décharge à l'aide d'un générateur HF, ce qui permet d'amorcer l'arc électrique à distance. Il existe un autre type d'amorçage, avec des inclusions de tungstène en faible quantité: l'amorçage au contact (lift arc) qui ne prévoit pas une haute fréquence mais seulement un court-circuit à faible intensité entre l'électrode et la pièce; en éloignant l'électrode l'arc s'amorcera et l'intensité augmentera jusqu'à atteindre la valeur de soudage programmée. Pour améliorer la qualité de la fin du cordon de soudure, il est utile de pouvoir vérifier avec précision l'évanouissement de l'intensité. Le gaz doit continuer à sortir sur le bain de soudure pendant quelques secondes après l'extinction de l'arc. Dans de nombreuses conditions opérationnelles, il est utile de disposer de 2 intensités de soudage préprogrammées et de pouvoir passer facilement de l'une à l'autre (BILEVEL, 4 temps à 2 niveaux).

FR

Polarité du soudage

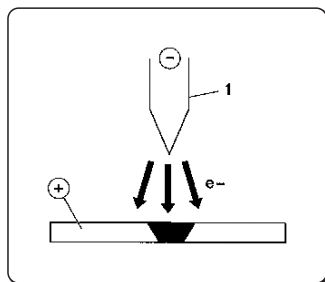

D.C.S.P. (Direct Current Straight Polarity)

Il s'agit de la polarité la plus utilisée (polarité directe ou normale), permettant une usure limitée de l'électrode (1) du fait que 70% de la chaleur se concentre sur l'anode (pièce).

On obtient des bains étroits et profonds avec de grandes vitesses d'avance et donc un apport thermique peu élevé.

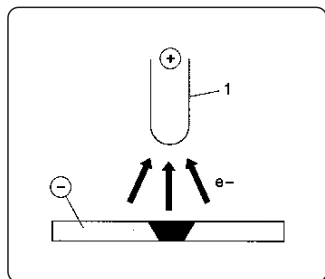

D.C.R.P. (Direct Current Reverse Polarity)

La polarité est inverse et cela permet de souder des alliages recouverts par une couche d'oxyde réfractaire avec une température de fusion supérieure à celle du métal.

On ne peut cependant pas employer des courants élevés car ils seraient la cause d'une usure importante de l'électrode.

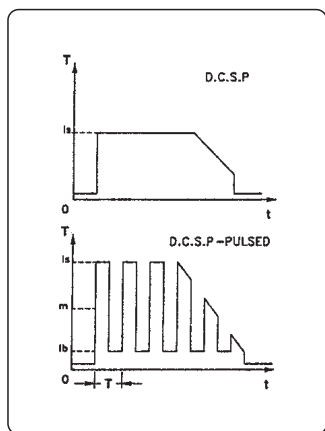

D.C.S.P.-Pulsed (Direct Current Straight Polarity Pulsed)

L'adoption d'un courant continu pulsé permet de mieux contrôler le bain de soudure, en des conditions d'exploitation spéciales.

Le bain de soudure se forme suite aux impulsions de crête (I_p), tandis que le courant de base (I_b) maintient l'arc allumé. Ce procédé facilite le soudage des faibles épaisseurs en obtenant des résultats de soudure avec moindres déformations, un meilleur facteur de marche et par conséquent un danger de fissures chaudes et d'inclusions gazeuses réduit.

Quand on augmente la fréquence (moyenne fréquence), on obtient un arc plus étroit, plus concentré et plus stable, et par la suite une plus grande qualité de la soudure des épaisseurs faibles.

FR

Soudage TIG des aciers

Le procédé TIG est très efficace pour souder de l'acier au carbone ou des alliages, pour la première passe sur les tubes et pour les soudures qui doivent avoir un aspect esthétique parfait. La polarité directe (D.C.S.P.) est nécessaire dans ce cas.

Préparation des bords

Le procédé impose un nettoyage parfait des bords et une préparation soignée.

Choix et préparation de l'électrode

Il est conseillé d'utiliser des électrodes en tungstène au thorium (2% de thorium couleur rouge) ou bien des électrodes au cérium ou au lanthane avec les diamètres suivants:

Ø électrode	Gamme de courant
1.0 mm	15÷75 A
1.6 mm	60÷150 A
2.4 mm	130÷240 A

L'électrode doit être affûtée comme indiqué sur le schéma.

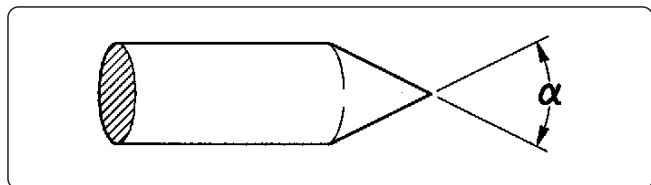

α°	Gamme de courant
30	0÷30 A
60÷90	30÷120 A
90÷120	120÷250 A

Métal d'apport

Les baguettes d'apport doivent avoir des propriétés mécaniques identiques à celles du matériau de base. Il est déconseillé d'utiliser des chutes provenant pièce à souder car elles peuvent contenir des impuretés dues à la manipulation et compromettre le soudage.

Gaz de protection

On utilise presque toujours l'Argon pur (99,99%).

Courant de soudage	Ø électrode	Buse n°	Buse	Flux d'argon
30 A	0÷30 mm	4/5	6/8.0 mm	5-6 l/min
60÷90 A	30÷120 mm	4/5/6	6.5/8.0/9.5 mm	6-7 l/min
90÷120 A	120÷250 mm	6/7	9.5/11.0 mm	7-8 l/min

Soudage TIG du cuivre

Le TIG étant un procédé à forte concentration thermique, il est particulièrement indiqué pour le soudage de matériaux à haute conduction thermique comme le cuivre.

Pour la soudure TIG du cuivre, suivre les mêmes indications que pour la soudure TIG de l'acier ou les textes spécifiques.

9.3 Soudage en continu (MIG/MAG)
Introduction

Un système MIG est formé d'un générateur à courant continu, d'un dévidoir de fil, d'une bobine de fil, d'une torche et de gaz.

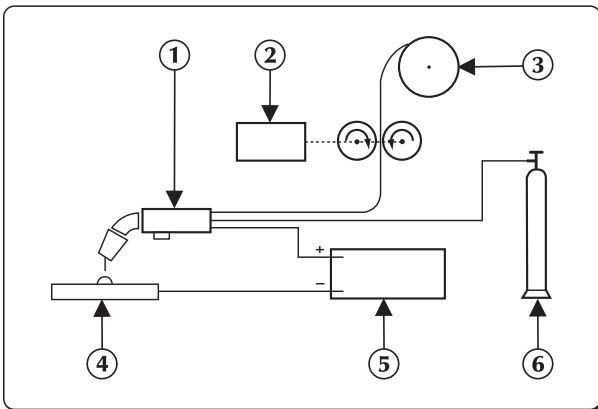
Installation de soudage MIG manuel

Le courant est transféré à l'arc par l'électrode fusible (câble placé sur la polarité positive);

Le métal fondu est déposé sur la pièce à souder à travers.

L'alimentation du fil est nécessaire pour remplacer le fil d'apport fondu durant la soudure.

Méthodes adoptées

Pour la soudure sous protection de gaz, la façon dont les gouttes se détachent de l'électrode permet d'avoir deux systèmes de transfert.

La première méthode appelée "TRANSFERT PAR COURTS-CIRCUITS (SHORT-ARC)" met l'électrode directement en contact avec le bain. Il se produit donc un court-circuit qui fond le fil qui s'interrompt, l'arc se rallume ensuite et le cycle se répète.

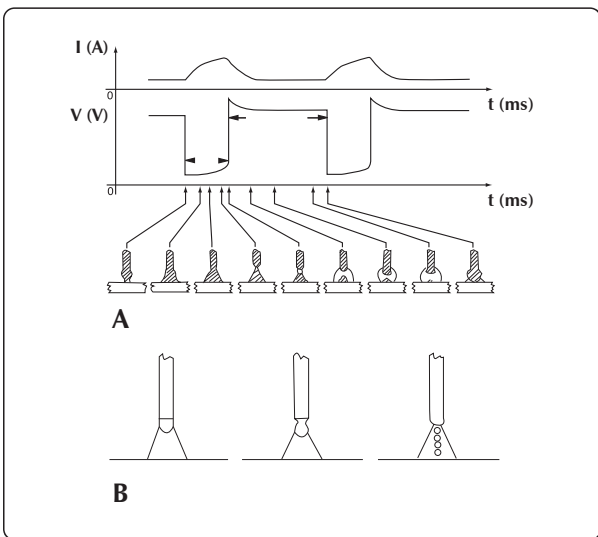
Régime ARC COURT (short arc) et régime ARC LONG/ PULVERISATION AXIALE (spray arc)

Une autre méthode pour obtenir le transfert des gouttes est celle appelée "TRANSFERT PAR PULVERISATION AXIALE (SPRAY-ARC)". Elle permet aux gouttes de se détacher de l'électrode et de tomber dans le bain de fusion en un deuxième temps.

FR

Paramètres de soudage

La visibilité de l'arc évite à l'opérateur de suivre strictement les panneaux de réglage, ce qui lui permet de contrôler le bain de fusion.

- La tension influe directement sur l'aspect du cordon, mais la taille du cordon peut être modifiée en fonction des exigences en agissant manuellement sur le mouvement de la torche afin d'obtenir des dépôts variables avec une tension constante.
- La vitesse d'avancement du fil dépend de l'intensité de soudage.

Les deux figures suivantes montrent les relations qui existent entre les différents paramètres de soudage.





Diagramme pour choisir la meilleure caractéristique de travail.

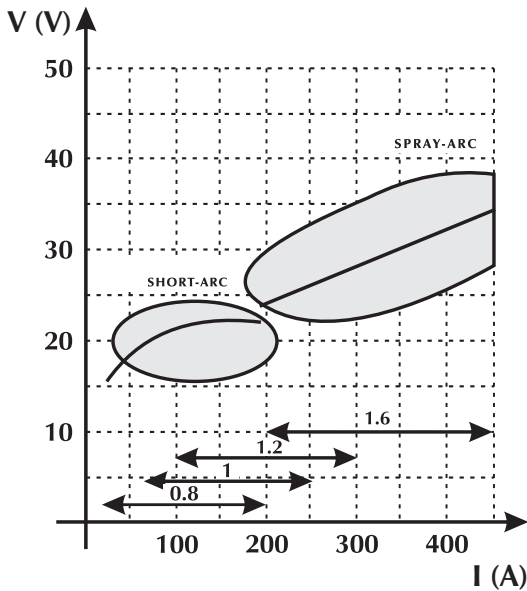
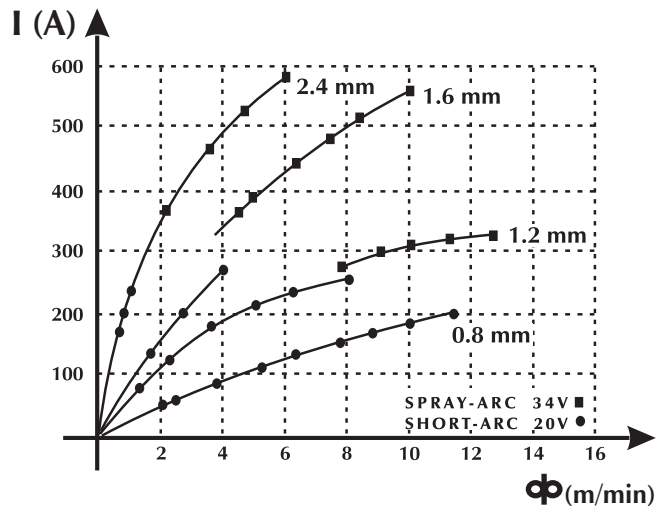
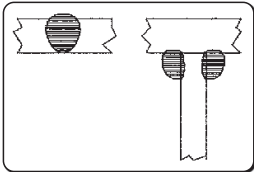
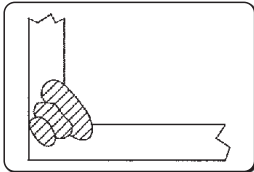
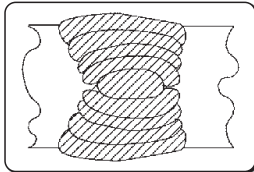

Rapport entre la vitesse d'avancement du fil et l'intensité du courant (caractéristique de fusion) en fonction du diamètre du fil.

Tableau permettant de choisir les paramètres de soudage en fonction des applications les plus classiques et des fils utilisés couramment

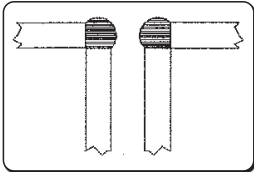
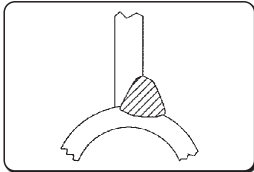
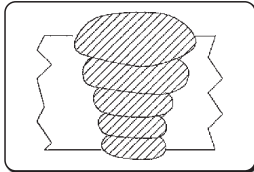
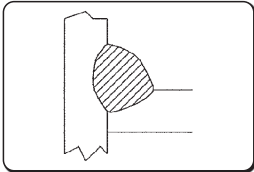
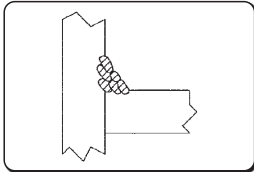
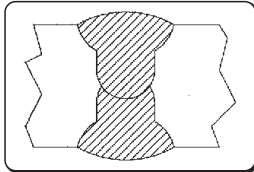
Tension de l'arc	Ø 0,8 mm	Ø 1,0-1,2 mm	Ø 1,6 mm	Ø 2,4 mm
16V - 22V SHORT - ARC				
	60 - 160 A Faible pénétration pour des fines épaisseurs	100 - 175 A Bon contrôle de la pénétration et de la fusion	120 - 180 A Bonne fusion à plat et verticale	150 - 200 A Non utilisé
	<hr/>			
	24V - 28V REGIME GLOBULAIRE (Zone de transition)			
150 - 250 A Soudure automatique d'angle		200 - 300 A Soudure automatique avec une tension élevée	250 - 350 A Soudure automatique descendante	300 - 400 A Non utilisé
<hr/>				
30V - 45V SPRAY - ARC				
	150 - 250 A Faible pénétration avec réglage à 200 A	200 - 350 A Soudure automatique à plusieurs passes	300 - 500 A Bonne pénétration avec une soudure descendante	500 - 750 A Bonne pénétration avec beaucoup de dépôt sur de grosses épaisseurs

FR

Gaz utilisables

La soudure MIG-MAG se caractérise surtout par le type de gaz utilisé, inerte pour la soudure MIG (Metal Inert Gas) et actif pour la soudure MAG (Metal Active Gas).

- Dioxyde de carbone (CO₂)

En utilisant le CO₂ comme gaz de protection, on obtient une pénétration optimale avec une grande vitesse d'avancement et de bonnes propriétés mécaniques, en ayant peu de frais. L'emploi de ce gaz donne malgré tout de gros problèmes sur la composition chimique finale des joints car il y a une perte d'éléments facilement oxydables et, en même temps, une augmentation de carbone dans le bain. La soudure avec du CO₂ pur donne également d'autres types de problèmes tels que la présence excessive de projections et la formation de porosités dues au monoxyde de carbone.

- Argon

Ce gaz inerte est utilisé pour souder des alliages légers mais il est préférable d'ajouter un pourcentage de 2% d'oxygène et de CO₂ pour souder l'acier inoxydable au chrome-nickel, ce qui contribue à la stabilité de l'arc et à améliorer la forme du cordon.

- Hélium

Utilisé à la place de l'argon, ce gaz permet davantage de pénétration (sur de grosses épaisseurs) et augmente la vitesse d'avancement.

- Mélange Argon-Hélium

Il permet d'obtenir un arc plus stable par rapport à l'hélium pur, davantage de pénétration et de vitesse par rapport à l'argon.

- Mélange Argon- CO₂ et Argon- CO₂-Oxygène

Ce type de mélange est utilisé pour souder des matériaux ferreux, surtout dans des conditions d'ARC COURT (short arc), car il améliore l'apport thermique spécifique. On peut néanmoins l'utiliser également dans des conditions d'ARC LONG/PULVERISATION AXIALE (spray arc).

Le mélange contient normalement un pourcentage entre 8% et 20% de CO₂ et environ 5% de O₂. Consulter le manuel d'instructions du générateur.

10. CARACTÉRISTIQUES TECHNIQUES

Caractéristiques électriques			U.M.
Tension d'alimentation U1 (50/60 Hz)	3x230 (±15%)	3x400 (±15%)	Vac
Zmax (@PCC) *	62	62	mΩ
Fusible retardé	30	20	A
Communication bus	DIGITAL	DIGITAL	
Puissance maximum absorbée	13.3	13.0	kVA
Puissance maximum absorbée	12.8	12.4	kW
Puissance absorbée à l'état inactif	71	71	W
Facteur de puissance (PF)	0.96	0.95	
Rendement (μ)	85	85	%
Cos φ	0.99	0.99	
Courant maximum absorbé I1max	32.9	18.8	A
Courant effectif I1eff	20.8	13.3	A
Gamme de réglage (MMA)	3-320	3-320	A
Tension du moteur de dévidoir Uo	75	75	Vdc

* Cet appareil pas conforme à la norme EN / IEC 61000-3-11.

* Ce matériel répond aux normes EN / IEC 61000-3-12 si l'impédance maximum possible du réseau au point d'interface du réseau public (point commun de couplage, PCC) est inférieure ou égale à la valeur donnée "Zmax". S'il est connecté à un réseau public basse tension, il est de la responsabilité de l'installateur ou de l'utilisateur de s'assurer, en consultant l'opérateur de réseau de distribution si nécessaire, que l'appareil peut être connecté.

Facteur d'utilisation	3x230V	3x400V	U.M.
Facteur d'utilisation MMA (40°C)			
(X=35%)	320	-	A
(X=50%)	-	320	A
(X=60%)	270	300	A
(X=100%)	230	250	A
Facteur d'utilisation MMA (25°C)			
(X=60%)	320	320	A
(X=100%)	270	270	A
Facteur d'utilisation TIG (40°C)			
(X=45%)	320	-	A
(X=60%)	300	320	A
(X=100%)	250	270	A
Facteur d'utilisation TIG (25°C)			
(X=70%)	320	320	A
(X=100%)	270	270	A
Facteur d'utilisation MIG/MAG (40°C)			
(X=35%)	320	-	A
(X=50%)	-	320	A
(X=60%)	280	310	A
(X=100%)	230	250	A
Facteur d'utilisation MIG/MAG (25°C)			
(X=60%)	320	-	A
(X=70%)	-	320	A
(X=100%)	270	270	A

Caractéristiques physiques			U.M.
Degré de protection IP	IP23S		
Classe d'isolation	H		
Dimensions (lxdxh)	620x240x460		mm
Poids	26.7		Kg
Normes de construction	EN IEC 60974-1/A1:2019 EN IEC 60974-3:2019 EN 60974-10/A1:2015		
Section câble d'alimentation	4x4		mm ²
Longueur du câble d'alimentation	5		m

11. PLAQUE DONNÉES

VOESTALPINE BÖHLER WELDING SELCO S.R.L. Via Palladio,19 - ONARA (PADOVA) - ITALY				
URANOS NX 3200 PME			N°	
EN 60974-1/A1:2019 IEC 60974-10/A1:2015 Class A				
	---	3A/20.0V - 320A (320A)/32.8V (32.8V)		
		X (40°C)	50% (35%)	60%
	U ₀	I ₂	320A (320A)	300A (270A) 250A (230A)
	75V	U ₂	32.8V (32.8V)	32.0V (30.8V) 30.0V (29.2V)
	---	3A/10.0V - 320A (320A)/22.8V (22.8V)		
		X (40°C)	(45%)	60%
	U ₀	I ₂	(320A)	320A (300A) 270A (250A)
	75V	U ₂	(22.8V)	22.8V (22.0V) 20.8V (20.0V)
	---	3A/14.0V - 320A (320A)/30.0V (30.0V)		
		X (40°C)	50% (35%)	60%
	U ₀	I ₂	320A (320A)	310A (280A) 250A (230A)
	75V	U ₂	30.0V (30.0V)	29.5V (28.5V) 26.5V (25.5V)
U ₁ 400V(230V)		I _{1max} 18.8A(32.9A)		I _{1eff} 13.3A(20.8A)
IP 23 S				

12. SIGNIFICATION DE LA PLAQUE DES DONNÉES

1		2			
3		4			
5		6			
7	9	23			
		11			
8	10	12	15	16	17
		13	15A	16A	17A
		14	15B	16B	17B
7	9	11			
		12	15	16	17
8	10	13	15A	16A	17A
		14	15B	16B	17B
18	19	20	21		
22					

CE Déclaration de conformité UE
 EAC Déclaration de conformité EAC
 UKCA Déclaration de conformité UKCA

- 1 Marque de fabrique
- 2 Nom et adresse du constructeur
- 3 Modèle de l'appareil
- 4 N° de série
 XXXXXXXXXXXX Année de fabrication
- 5 Symbole du type de générateur
- 6 Référence aux normes de construction
- 7 Symbole du mode de soudage
- 8 Symbole pour les générateurs susceptibles d'être utilisés dans des locaux à fort risque de décharges électriques
- 9 Symbole du courant de soudage
- 10 Tension nominale à vide
- 11 Gamme du courant maximum et minimum et de la tension conventionnelle de charge correspondante.
- 12 Symbole du cycle d'intermittence
- 13 Symbole du courant nominal de soudage
- 14 Symbole de la tension nominale de soudage
- 15 Valeurs du cycle d'intermittence
- 16 Valeurs du cycle d'intermittence
- 17 Valeurs du cycle d'intermittence
- 15A Valeurs du courant nominal de soudage
- 16A Valeurs du courant nominal de soudage
- 17A Valeurs du courant nominal de soudage
- 15B Valeurs de la tension conventionnelle de charge
- 16B Valeurs de la tension conventionnelle de charge
- 17B Valeurs de la tension conventionnelle de charge
- 18 Symbole pour l'alimentation
- 19 Tension nominale d'alimentation
- 20 Courant maximum nominal d'alimentation
- 21 Courant maximum effectif d'alimentation
- 22 Degré de protection
- 23 Tension nominal de pic

FR

FR

DECLARACIÓN UE DE CONFORMIDAD

El constructor

voestalpine Böhler Welding Selco S.r.l. - Via Palladio, 19 - 35019 Onara di Tombolo (PD) - ITALY
Tel. +39 049 9413/111 - Fax +39 049 9413/311 - www.voestalpine.com/welding

declara bajo su exclusiva responsabilidad que el siguiente producto:

URANOS NX 3200 PME	55.03.066
	55.03.070

es conforme a las directivas EU:

2014/35/EU LOW VOLTAGE DIRECTIVE
2014/30/EU EMC DIRECTIVE
2011/65/EU RoHS DIRECTIVE

y que se han aplicado las siguientes normas armonizadas:

EN IEC 60974-1/A1:2019	WELDING POWER SOURCE
EN 60974-10/A1:2015	ELECTROMAGNETIC COMPATIBILITY REQUIREMENTS

La documentación que acredite el cumplimiento de las directivas se mantendrá disponible para inspecciones en el mencionado fabricante.

Toda reparación, o modificación, no autorizada por voestalpine Böhler Welding Selco S.r.l. hará decaer la validez invalidará esta declaración.

Onara di Tombolo, 15/10/2021

voestalpine Böhler Welding Selco s.r.l.

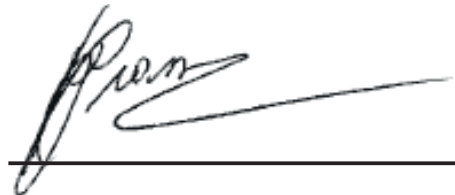

Lino Frasson

INDICE

1. ADVERTENCIA	191
1.1 Entorno de utilización	191
1.2 Protección personal y de terceros	191
1.3 Protección contra los humos y gases	192
1.4 Prevención contra incendios/explosiones	192
1.5 Prevención durante el uso de las botellas de gas	193
1.6 Protección contra descargas eléctricas	193
1.7 Campos electromagnéticos y interferencias	193
1.8 Grado de protección IP	194
1.9 Eliminación	194
2. INSTALACIÓN	195
2.1 Elevación, transporte y descarga	195
2.2 Colocación del equipo	195
2.3 Conexión	195
2.4 Instalación	196
3. PRESENTACIÓN DEL SISTEMA	198
3.1 Panel posterior	198
3.2 Panel de las tomas	198
3.3 Panel de mandos frontal	198
3.4 Panel de mandos frontal	199
4. UTILIZACIÓN DEL EQUIPO	200
4.1 Pantalla de inicio	200
4.2 Pantalla de test	200
4.3 Pantalla principal	201
4.4 Pantalla principal del proceso MMA	201
5. CONFIGURACIÓN	208
5.1 Configuración y ajuste de los parámetros	208
5.2 Procedimientos específicos de uso de los parámetros	217
6. MANTENIMIENTO	222
6.1 Controles periódicos de la fuente de alimentación	222
6.2 Responsabilidad	222
7. CODIFICACIÓN DE ALARMAS	222
8. DIAGNÓSTICO Y SOLUCIÓN DE PROBLEMAS	224
9. NOCIONES TEÓRICAS SOBRE LA SOLDADURA	228
9.1 Soldaduras con electrodo recubierto (MMA)	228
9.2 Soldadura TIG (arco continuo)	229
9.3 Soldadura con alambre continuo (MIG/MAG)	230
10. CARACTERÍSTICAS TÉCNICAS	233
11. PLACA DE CARACTERÍSTICAS	234
12. SIGNIFICADO DE LA ETIQUETA DE LOS DATOS	234
13. ESQUEMA	557
14. CONECTORES	559
15. LISTA DE REPUESTOS	560

SÍMBOLOS



Peligros inminentes que causan lesiones graves y comportamientos peligrosos que podrían causar lesiones graves.



Comportamientos que podrían causar lesiones no leves, o daños a las cosas.



Las notas anteceditas precedidas de este símbolo son de carácter técnico y facilitan las operaciones.

1. ADVERTENCIA



Antes de comenzar cualquier tipo de operación, tiene que haber comprendido el contenido del presente manual. No efectúe modificaciones ni mantenimientos no descritos en este manual. El fabricante no es responsable por daños a personas o cosas causados por una lectura, o una puesta en aplicación negligente de cuanto escrito del contenido de este manual.

Förvara alltid bruksanvisningen på den plats där apparaten används. Följ utöver bruksanvisningen även de allmänna föreskrifterna och gällande lokala bestämmelser om förebyggande av olyckor och miljöskydd.



Alla personer som ansvarar för driftsättningen, användningen, underhållet och reparationen av apparaten ska

- ha rätt kvalifikation
- ha nödvändiga svetskunskaper
- läsa hela bruksanvisningen och följa den noggrant

En caso de dudas o problemas sobre la utilización del equipo, aunque no se indiquen aquí, consulte con personal cualificado.

1.1 Entorno de utilización



El equipo debe utilizarse exclusivamente para las operaciones para las cuales ha sido diseñado, en los modos y dentro de los campos previstos en la placa de identificación y/o en este manual, según las directivas nacionales e internacionales sobre la seguridad. Un uso diferente del declarado por el fabricante se considera inadecuado y peligroso; en dicho caso, el fabricante no asumirá ninguna responsabilidad.



Este equipo tiene que debe utilizarse sólo para fines profesionales en un local industrial. El fabricante no responde de daños provocados por un uso del equipo en entornos domésticos.



El equipo debe utilizarse en locales con una temperatura comprendida entre -10°C y +40°C (entre +14°F y +104°F). El equipo debe transportarse y almacenarse en locales con una temperatura comprendida entre -25°C y +55°C (entre -13°F y 131°F).

El equipo debe utilizarse en locales sin polvo, ácidos, gases ni otras sustancias corrosivas.

El equipo debe utilizarse en locales con una humedad relativa no superior al 50% a 40°C (104°F).

El equipo debe utilizarse en locales con una humedad relativa no superior al 90% a 20°C (68°F).

El equipo debe utilizarse a una altitud máxima sobre el nivel del mar de 2000 m (6500 pies).



No utilizar dicho aparato para descongelar tubos.

No utilice el equipo para cargar baterías ni acumuladores.

No utilice el equipo para hacer arrancar motores.

1.2 Protección personal y de terceros



El proceso de soldadura es una fuente nociva de radiaciones, ruido, calor y emanaciones gaseosas. Coloque una pared divisoria ignífuga para proteger la zona de soldadura de los rayos, chispas y escorias incandescentes. Advierta a las demás personas que se protejan de los rayos del arco, o del metal incandescente y que no los fijamente.



Póngase prendas de protección para proteger la piel de los rayos del arco y de las chispas, o del metal incandescente. La indumentaria utilizada debe cubrir todo el cuerpo y debe ser:

- íntegra y en buenas condiciones
- ignífuga
- aislante y seca
- ceñida al cuerpo y sin dobleces



Utilice siempre zapatos resistentes y herméticos al agua.

Utilice siempre guantes que garanticen el aislamiento eléctrico y térmico.



Use máscaras con protecciones laterales para la cara y filtro de protección adecuado para los ojos (al menos NR10 o mayor).



Utilice siempre gafas de seguridad con aletas laterales, especialmente cuando tenga que deba retirar manual o mecánicamente las escorias de soldadura.



¡No use lentes de contacto!



Use auriculares si el proceso de soldadura es muy ruidoso. Si el nivel de ruido supera los límites indicados por la ley, delimite la zona de trabajo y cerciórese de que las personas que entren en la misma estén protegidas con auriculares.



Mantenga siempre las tapas laterales cerradas durante los trabajos de soldadura. El equipo no debe ser modificado.



Mantenga siempre las tapas laterales cerradas durante los trabajos de soldadura. Evite el contacto entre manos, cabellos, ropas, herramientas, etc. y piezas móviles, a saber: ventiladores, ruedas dentadas, rodillos y ejes, bobinas de hilo. No trabaje sobre las ruedas dentadas cuando el alimentador de alambre está funcionando. El equipo no debe ser modificado. La desactivación de los dispositivos de protección en las unidades de avance del alambre es muy peligrosa y el fabricante no asumirá ninguna responsabilidad por los daños provocados a personas y bienes.



Mantenga la cabeza lejos de la antorcha mig/mag durante la carga y el avance del alambre. El alambre que sale puede provocar lesiones graves en las manos, el rostro y los ojos.



No toque las piezas recién soldadas, el calor excesivo podría provocar graves quemaduras. Tome todas las medidas de precaución anteriores incluso durante los trabajos de post-soldadura, puesto que de las piezas que se están enfriando podrían saltar escorias.



Compruebe que la antorcha se haya enfriado antes de efectuar trabajos o mantenimientos.



Compruebe que el grupo de refrigeración esté apagado antes de desconectar los tubos de suministro y de retorno del líquido refrigerante. El líquido caliente que sale podría provocar graves quemaduras.



Tenga a mano un equipo de primeros auxilios. No subestime quemaduras o heridas.



Antes de abandonar el puesto de trabajo, tome todas las medidas de seguridad para dejar la zona de trabajo segura y así impedir accidentes graves a personas o bienes.

1.3 Protección contra los humos y gases



Los humos, gases y polvos producidos por la soldadura pueden ser perjudiciales para la salud. El humo producido durante la soldadura en determinadas circunstancias, puede provocar cáncer o daños al feto en las mujeres embarazadas.

- Mantenga la cabeza lejos de los gases y del humo de soldadura.
- Proporcione una ventilación adecuada, natural o forzada, en la zona de trabajo.
- En el caso de ventilación insuficiente, utilice mascarillas con respiradores.
- En el caso de soldaduras en lugares angostos, se aconseja que una persona controle al operador desde el exterior.
- No use oxígeno para la ventilación.
- Compruebe la eficacia de la aspiración, comparando periódicamente las emisiones de gases nocivos con los valores admitidos por las normas de seguridad.
- La cantidad y el peligro de los humos producidos dependen del material utilizado, del material de soldadura y de las sustancias utilizadas para la limpieza y el desengrase de las piezas a soldar. Respete escrupulosamente las indicaciones del fabricante y las fichas técnicas.
- No suelde en lugares donde se efectúen desengrases o donde se pinte.
- Coloque las botellas de gas en espacios abiertos, o con una buena circulación de aire.

1.4 Prevención contra incendios/explosiones



El proceso de soldadura puede originar incendios y/o explosiones.

- Retire de la zona de trabajo y de aquella la circundante los materiales, o u objetos inflamables o combustibles.
- Los materiales inflamables deben estar a 11 metros (35 pies) como mínimo del local de soldadura o deben estar protegidos perfectamente.
- Las proyecciones de chispas y partículas incandescentes pueden llegar fácilmente a las zonas de circundantes, incluso a través de pequeñas aberturas. Observe escrupulosamente la seguridad de las personas y de los bienes.
- No suelde encima o cerca de recipientes bajo presión.
- No suelde recipientes o tubos cerrados. Tenga mucho cuidado durante la soldadura de tubos o recipientes, incluso si éstos están abiertos, vacíos y bien limpios. Los residuos de gas, combustible, aceite o similares podrían provocar explosiones.
- No suelde en lugares donde haya polvos, gas, o vapores explosivos.

- Al final de la soldadura, compruebe que el circuito bajo tensión no puede tocar accidentalmente piezas conectadas al circuito de masa.
- Coloque en la cerca de la zona de trabajo un equipo o dispositivo antiincendio.

1.5 Prevención durante el uso de las botellas de gas



Las botellas de gas inerte contienen gas bajo presión y pueden explotar si no se respetan las condiciones mínimas de transporte, mantenimiento y uso.

- Las botellas deben estar sujetas verticalmente a paredes o a otros soportes con elementos adecuados para que no se caigan ni se choquen contra otros objetos.
- Enrosque la tapa de protección de la válvula durante el transporte, la puesta en servicio y cuando concluyan las operaciones de soldadura.
- No exponga las botellas directamente a los rayos solares, a cambios bruscos de temperatura, a temperaturas muy altas o muy bajas. No exponga las botellas a temperaturas muy rígidas ni demasiado altas o bajas.
- Las botellas no deben tener contacto con llamas libres, con arcos eléctricos, antorchas, pinzas portaelectrodos, ni con las proyecciones incandescentes producidas por la soldadura.
- Mantenga las botellas lejos de los circuitos de soldadura y de los circuitos de corriente eléctrica en general.
- Mantenga la cabeza lejos del punto de salida del gas cuando abra la válvula de la botella.
- Cierre la válvula de la botella cuando haya terminado de soldar.
- Nunca suelde sobre una botella de gas bajo presión.
- No conecte una botella de aire comprimido directamente con el reductor de la máquina! Si la presión sobrepasa la capacidad del reductor, éste podría estallar!

1.6 Protección contra descargas eléctricas



Las descargas eléctricas suponen un peligro de muerte.

- No toque las piezas internas ni externas bajo tensión del equipo de soldadura mientras el equipo éste se encuentre activado (antorchas, pinzas, cables de masa, electrodos, alambres, rodillos y bobinas están conectados eléctricamente al circuito de soldadura).
- Compruebe el aislamiento eléctrico del equipo, utilizando superficies y bases secas y aisladas perfectamente del potencia de tierra y de masa de la tierra.
- Compruebe que el equipo esté conectado correctamente a una toma y a una fuente de alimentación dotada de conductor de protección de tierra.
- No toque simultáneamente dos antorchas, o dos pinzas portaelectrodos.
- Interrumpa inmediatamente la soldadura si nota una descarga eléctrica.

1.7 Campos electromagnéticos y interferencias



El paso de la corriente a través de los cables internos y externos del equipo crea un campo electromagnético cerca de los cables de soldadura y del mismo equipo.

- Los campos electromagnéticos pueden ser perjudiciales (desconocen los efectos exactos) para la salud de una persona expuesta durante mucho tiempo.
- Los campos electromagnéticos pueden interferir con otros equipos tales como marcapasos o aparatos acústicos.



Las personas con aparatos electrónicos vitales (marcapasos) deberían consultar al médico antes de acercarse al área donde se están efectuando soldaduras por arco.

1.7.1 Clasificación EMC in acuerdo con la Normativa: EN 60974-10/A1:2015.



Le matériel de classe B est conforme aux exigences de compatibilité électromagnétique en milieu industriel et résidentiel, y compris en environnement résidentiel où l'alimentation électrique est distribuée par un réseau public basse tension.



Le matériel de classe A n'est pas conçu pour être utilisé en environnement résidentiel où l'alimentation électrique est distribuée par un réseau public basse tension. Puede ser potencialmente difícil asegurar la compatibilidad electromagnética de los dispositivos de clase A en estas áreas, a causa de las perturbaciones irradiadas y conducidas.

Para más información, consulte el capítulo: ETIQUETA DE DATOS o CARACTERÍSTICAS TÉCNICAS.

1.7.2 Instalación, uso y evaluación del área

Este equipo responde a las indicaciones especificaciones de la norma armonizada EN 60974-10/A1:2015 y se identifica como de "CLASE A". Este equipo tiene que debe utilizarse sólo para fines profesionales en un local industrial. El fabricante no responde de daños provocados por un uso del equipo en entornos domésticos.



El usuario debe ser un experto del sector y como tal es responsable de la instalación y del uso del aparato según las indicaciones del fabricante. Si se detectasen perturbaciones electromagnéticas, el usuario del equipo tendrá que resolver la situación sirviéndose de la asistencia técnica del fabricante.



Debe procurar reducir las perturbaciones electromagnéticas hasta un nivel que no resulte molesto.



Antes de instalar este equipo, el usuario tiene que evaluar los potenciales problemas electro-magnéticos que podrían producirse en la zona circundante y, en particular, la salud de las personas expuestas, por ejemplo: personas con marcapasos y aparatos acústicos.

1.7.3 Requisitos de alimentación de red

Los dispositivos de elevada potencia pueden influir en la calidad de la energía de la red de distribución a causa de la corriente absorbida. Consiguientemente, para algunos tipos de dispositivos (consulte los datos técnicos) pueden aplicarse algunas restricciones de conexión o algunos requisitos en relación con la máxima impedancia de red admitida (Z_{max}) o la mínima potencia de instalación (S_{sc}) disponible en el punto de interacción con la red pública (punto de acoplamiento común - "Point of Common Coupling" PCC). En este caso, es responsabilidad del instalador o del usuario, consultando al gestor de la red si es necesario, asegurarse de que el dispositivo se puede conectar. En caso de interferencia, podría ser necesario tomar adicionales, como por ejemplo colocar filtros en la alimentación de la red.

Además, considere la posibilidad de blindar el cable de alimentación.

Para más información, consulte el capítulo: CARACTERÍSTICAS TÉCNICAS.

1.7.4 Precauciones en el uso de los cables

Para minimizar los efectos de los campos electromagnéticos, respete las siguientes reglas:

- Enrolle juntos y fije, cuando sea posible, el cable de masa y el cable de potencia.
- No se enrolle los cables alrededor del cuerpo.
- No se coloque entre el cable de masa y el cable de potencia (mantenga ambos cables del mismo lado).
- Los cables tienen que ser lo más cortos posible, estar situarse cerca el uno del otro y pasar por encima o cerca del nivel del suelo.
- Coloque el equipo a una cierta distancia de la zona de soldadura.
- Los cables deben estar apartados de otros cables.

1.7.5 Conexión equipotencial

Tenga en cuenta que todos los componentes metálicos de la instalación del equipo de soldadura (corte) y aquéllos los que se encuentran cerca tienen que estar conectados a tierra. Respete las normativas nacionales referentes a la conexión equipotencial.

1.7.6 Puesta a tierra de la pieza de trabajo

Cuando la pieza de trabajo no está conectada a tierra por motivos de seguridad eléctrica, o a debido a sus dimensiones y posición, la conexión a tierra entre la pieza y la tierra de la pieza podría reducir las emisiones. Es importante procurar en que la conexión a tierra de la pieza de trabajo no aumente el riesgo de accidente de los operadores, y que no dañe otros aparatos eléctricos. Respete las normativas nacionales referentes a la conexión a tierra.

1.7.7 Blindaje

El blindaje selectivo de otros cables y aparatos presentes en la zona circundante puede reducir los problemas de interferencia. En caso de aplicaciones especiales, también puede considerarse el blindaje de todo el equipo de soldadura.

1.8 Grado de protección IP



IP23S

- Para evitar el contacto de los dedos con partes peligrosas y la entrada de cuerpos sólidos extraños de diámetro mayor/igual a 12.5 mm.
- Envoltura protegida contra la lluvia a 60° sobre la vertical.
- Envoltura protegida contra los efectos perjudiciales debidos a la entrada de agua, cuando las partes móviles del aparato no están en movimiento.

1.9 Eliminación



¡No arroje nunca el equipo eléctrico entre los residuos comunes!

Con arreglo a la Directiva Europea 2012/19/UE sobre Residuos de Aparatos Eléctricos y Electrónicos y su implementación de acuerdo con las leyes nacionales, los aparatos eléctricos que hayan llegado al final de su ciclo de vida deben recogerse por separado y enviarse a un centro de recuperación y eliminación. El propietario del aparato debe identificar los centros de recogida autorizados consultando con las Administraciones Locales. La aplicación de la Directiva Europea permitirá mejorar el medio ambiente y la salud humana.

2. INSTALACIÓN



La instalación debe efectuarla solamente personal experto y habilitado por el fabricante.



Durante la instalación compruebe que el la fuente de alimentación esté desconectada de la toma de corriente.



La conexión de los fuentes de alimentación en serie o en paralelo está prohibida.

2.1 Elevación, transporte y descarga

- El equipo incorpora un asa que permite desplazarlo a mano.
- El equipo no incorpora elementos específicos para la elevación.
- Utilice una carretilla elevadora de horquillas, desplazándose con cuidado a fin de evitar que el generador pueda volcarse.



No subestime el peso del equipo, consulte las características técnicas.
No traslade ni detenga la carga encima de personas u objetos.
No aplique una presión excesiva sobre el equipo.

2.2 Colocación del equipo



Observe las siguientes normas:

- El acceso a los mandos y conexiones tiene que ser fácil.
- No coloque el equipo en lugares estrechos.
- No coloque nunca el equipo sobre una superficie con una inclinación superior a 10° respecto del plano horizontal.
- Coloque el equipo en un lugar seco, limpio y con ventilación apropiada.
- Proteja la instalación de la lluvia y del sol.

2.3 Conexión

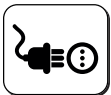

El equipo incluye un cable de alimentación para la conexión a la red.
El equipo puede alimentarse con:

- 400V trifásica
- 230V trifásica

El funcionamiento del equipo está garantizado para tensiones que se alejan de hasta el $\pm 15\%$ del valor nominal; (ejemplo: Vnom 400V la tensión de trabajo está comprendida entre 320V y 440V).



Para evitar daños a las personas o a la instalación, es necesario controlar la tensión de red seleccionada y los fusibles ANTES de conectar la máquina a la red. Compruebe también que el cable esté conectado a una toma con contacto de tierra.



Es posible alimentar el equipo mediante un grupo electrógeno, siempre que garantice una tensión de alimentación estable entre el $\pm 15\%$ respecto del valor de la tensión nominal declarado por el fabricante, en todas las condiciones de funcionamiento posibles y con la máxima potencia suministrable por el generador nominal. Por lo general, se aconseja utilizar grupos electrógenos de potencia con el doble de potencia de la fuente de alimentación si es monofásica, y equivalente a 1,5 veces si es trifásica. Se aconseja la utilización de grupos electrógenos con controlador electrónico.



Para la protección de los usuarios, el equipo debe estar correctamente conectado a tierra. El cable de alimentación cuenta con un conductor (amarillo - verde) para la puesta a tierra, que debe ser conectarse a una clavija con contacto de tierra. NUNCA use el cable amarillo/verde junto con otro cable para tomar la corriente. Compruebe que el equipo disponga de conexión a tierra y que las tomas de corriente estén en buenas condiciones. Instale sólo enchufes homologados de acuerdo con las normativas de seguridad.



La instalación eléctrica debe efectuarla personal técnico con requisitos técnico profesionales específicos y de conformidad con las leyes del país en el cual se efectúa la instalación.

2.4 Instalación

2.4.1 Conexión para la soldadura MMA



La conexión que muestra la figura da como resultado una soldadura con polaridad invertida. Para obtener una soldadura con polaridad directa, invierta la conexión.

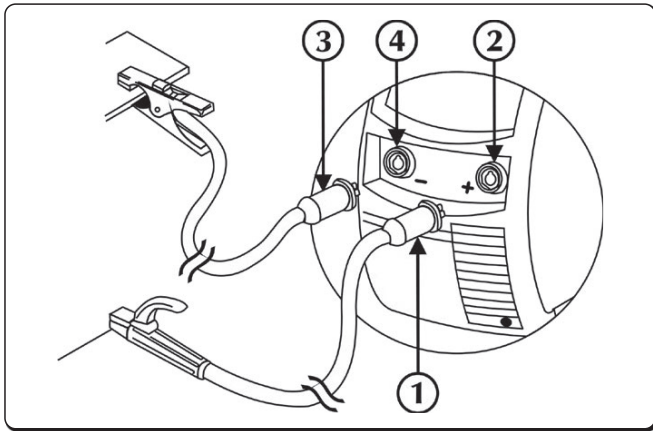

- ① Conector de la pinza de masa
- ② Toma negativa de potencia (-)
- ③ Conector de la pinza portaelectrodos
- ④ Toma positiva de potencia (+)

- ▶ Conecte el conector del cable de la pinza de masa a la toma negativa (-) del generador. Inserte la clavija y gire hacia la derecha que todas las piezas queden fijadas.
- ▶ Conecte el conector del cable de la pinza portaelectrodo a la toma positiva (+) del generador. Inserte la clavija y gire hacia la derecha que todas las piezas queden fijadas.

2.4.2 Conexión para la soldadura TIG

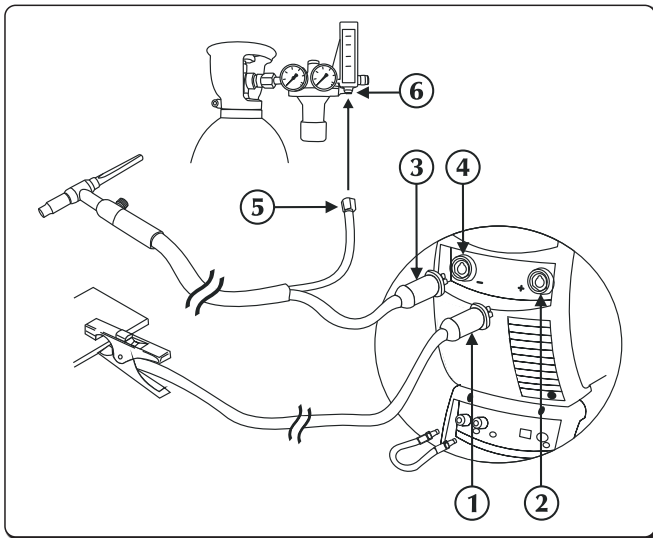

- ① Conector de la pinza de masa
- ② Toma positiva de potencia (+)
- ③ Conexión de la antorcha TIG
- ④ Toma de antorcha
- ⑤ Conector de tubería de gas
- ⑥ Reductor de presión

- ▶ Conecte el conector del cable de la pinza de masa a la toma positiva (+) del generador. Inserte la clavija y gire hacia la derecha que todas las piezas queden fijadas.
- ▶ Conecte la unión de la antorcha TIG a la toma de la antorcha del generador. Inserte la clavija y gire hacia la derecha que todas las piezas queden fijadas.



Puede ajustar el flujo de gas de protección con la llave situada normalmente sobre la antorcha.

- ▶ Conecte por separado el conector del tubo de gas de la antorcha a la distribución del gas.
- ▶ Conecte el tubo de retorno del líquido refrigerante agua de color rojo de la antorcha al conector de entrada de la unidad de refrigeración (color rojo - símbolo).
- ▶ Conecte el tubo de alimentación del líquido refrigerante agua de color azul de la antorcha al conector de salida de la unidad de refrigeración (color azul - símbolo).

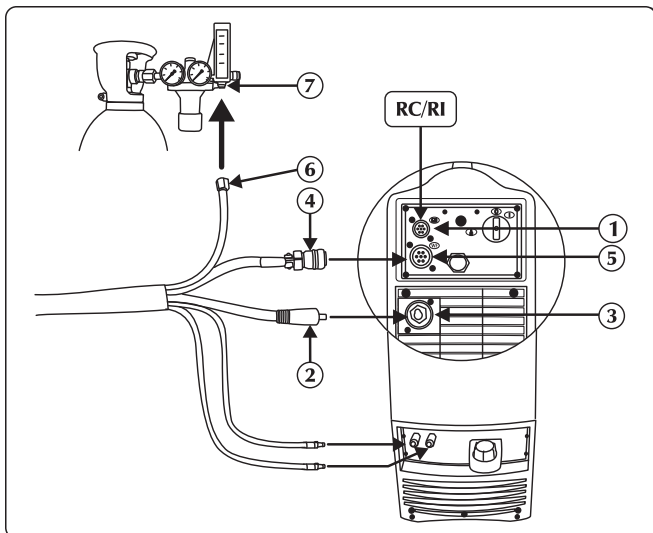
2.4.3 Conexión para soldadura MIG/MAG

- ① Entrada de cable de señal (CAN-BUS)
- ② Cable de potencia
- ③ Toma positiva de potencia (+)
- ④ Cable de señal
- ⑤ Entrada del cable de señal (CAN-BUS) (Manguera)
- ⑥ Tubo de gas
- ⑦ Conexión alimentación de gas

- ▶ Conecte el cable de potencia a del haz de cables en la toma correspondiente. Inserte la clavija y gire hacia la derecha que todas las piezas queden fijadas.
- ▶ Inserte el cable de señal al del haz de cables en el conector correspondiente. Inserte el conector y gire la tuerca en sentido horario hasta que las piezas queden completamente fijadas.
- ▶ Conecte el tubo de gas al reductor de presión de la botella o al racor de suministro del gas. Ajuste el flujo de gas de 10 a 30 l/min.
- ▶ Conecte el tubo de alimentación del líquido refrigerante agua del haz de cables (color azul) al conector de salida de la unidad de refrigeración (color azul - símbolo).
- ▶ Conecte el tubo de retorno del líquido refrigerante agua del haz de cables (color rojo) al conector de entrada de la unidad de refrigeración (color rojo - símbolo).

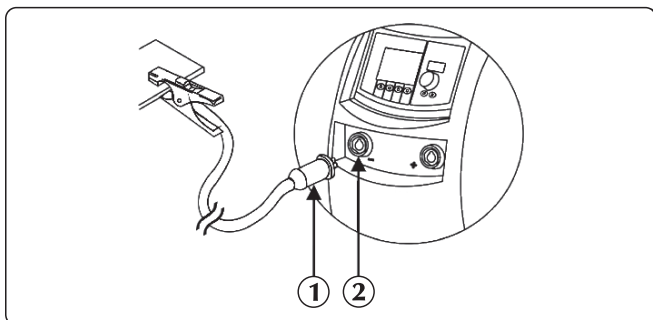

- ① Conector de la pinza de masa
- ② Toma negativa de potencia (-)

- ▶ Conecte el conector del cable de la pinza de masa a la toma negativa (-) del generador. Inserte la clavija y gire hacia la derecha que todas las piezas queden fijadas.

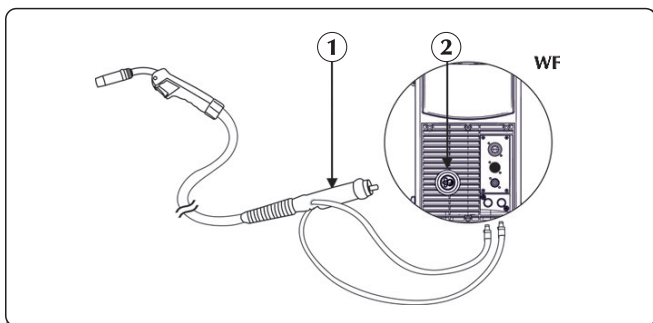

- ① Conexión de la antorcha
- ② Conectore

- ▶ Conecte el tubo de alimentación del líquido refrigerante agua de color azul de la antorcha al conector de salida de la unidad de refrigeración (color azul - símbolo).
- ▶ Conecte el tubo de retorno del líquido refrigerante agua de color rojo de la antorcha al conector de entrada de la unidad de refrigeración (color rojo - símbolo).
- ▶ Conectar la antorcha MIG/MAG al adaptador central comprobando que el anillo de sujeción esté totalmente apretado.

ES

3. PRESENTACIÓN DEL SISTEMA

3.1 Panel posterior

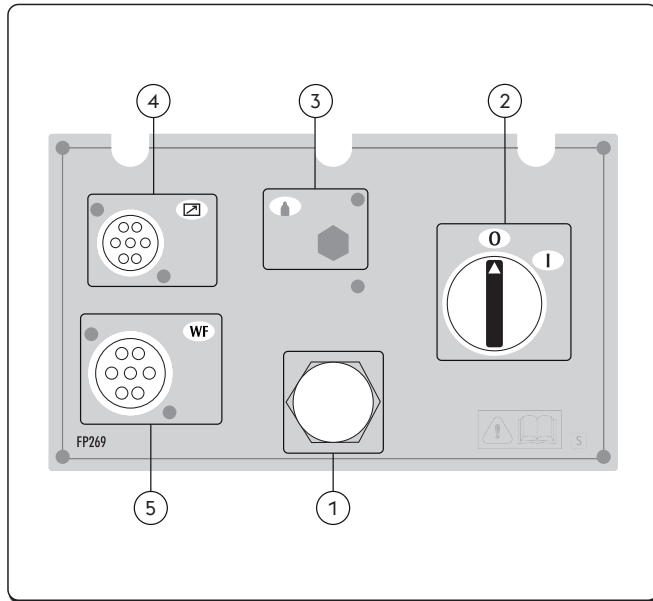

- ① **Cable de alimentación.**
Conecta el sistema a la red.
- ② **Conmutador de activación**
Activa la soldadora.
Tiene dos posiciones "0" desactivado; "I" activado.
- ③ **No utilizado**
- ④ **Entrada de cable de señal CAN-BUS (RC, RI...)**
- ⑤ **Entrada del cable de señal (CAN-BUS) (Manguera)**

3.2 Panel de las tomas

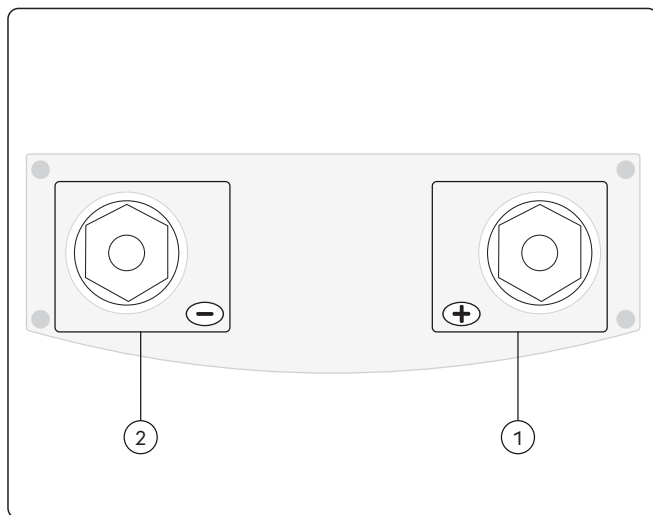

- ① **Toma positiva de potencia (+)**
Proceso MMA: Conexión antorcha de electrodos
Proceso TIG: Conexión cable de tierra
- ② **Toma negativa de potencia (-)**
Proceso MMA: Conexión cable de tierra
Proceso TIG: Conexión antorcha
Proceso MIG/MAG: Conexión cable de tierra

3.3 Panel de mandos frontal

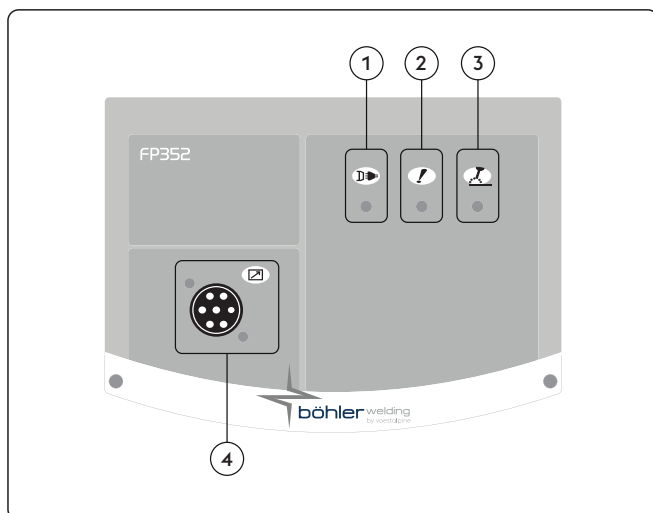





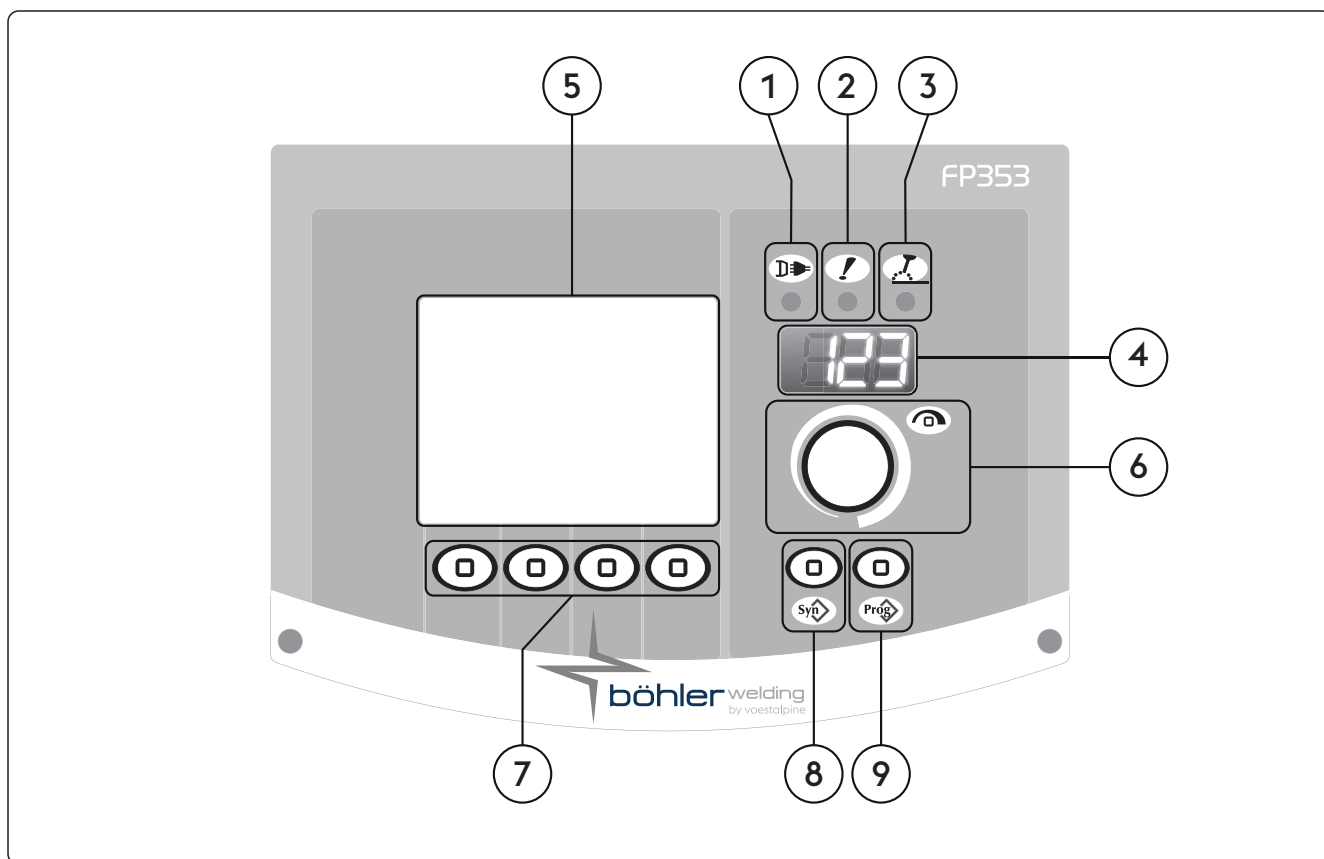

- ① **Led de encendido**
Indica que el equipo está conectado a la red y está activado.
- ② **Led de alarma general**
Indica la posible intervención de dispositivos de protección como la protección de temperatura.
- ③ **Led de potencia activa**
Indica la presencia de tensión en las conexiones de la toma del equipo.
- ④ **Entrada de cable de señal CAN-BUS (RC, RI...)**

3.4 Panel de mandos frontal



ES

- 1  **Led de encendido**
Indica que el equipo está conectado a la red y está activado.
- 2  **Led de alarma general**
Indica la posible intervención de dispositivos de protección como la protección de temperatura.
- 3  **Led de potencia activa**
Indica la presencia de tensión en las conexiones de la toma del equipo.
- 4  **Pantalla de 7 segmentos**
Permite que se visualicen los parámetros generales de soldadura de la máquina durante el arranque, los ajustes, las lecturas de corriente y tensión, durante la soldadura, y en la codificación de las alarmas.
- 5  **Pantalla LCD**
Permite que se visualicen los parámetros generales de soldadura de la máquina durante el arranque, los ajustes, las lecturas de corriente y tensión, durante la soldadura, y en la codificación de las alarmas.
Permite visualizar instantáneamente todas las operaciones.
- 6  **Encoder**
Permite que la entrada se configure, así como la selección y la configuración de los parámetros de soldadura.
- 7  **Botones de función**
Permiten seleccionar las diferentes funciones del equipo:
 - Procedé de soudage
 - Sequencia del micro interruptor
 - Tipos de corriente
 - Modalidad gráfica

8 Botón programas

Permite seleccionar un programa de soldadura predefinido mediante la selección de algunas informaciones sencillas:

- Tipo de hilo
- Tipo de gas
- Diámetro del alambre

9 Botón job

Permite memorizar y gestionar 240 programas de soldadura personalizables por el usuario.

4. UTILIZACIÓN DEL EQUIPO

4.1 Pantalla de inicio

Durante el arranque, el generador realiza una serie de verificaciones para garantizar el correcto funcionamiento del equipo y de todos los dispositivos conectados al mismo. En esta fase también se realiza la prueba de gas para establecer la correcta conexión con el sistema de alimentación del gas.

4.2 Pantalla de test

Cuando se abre el panel lateral (alojamiento de la bobina), las operaciones de soldadura quedan inhabilitadas. Compare la pantalla de test con lo que se visualice en la LCD.

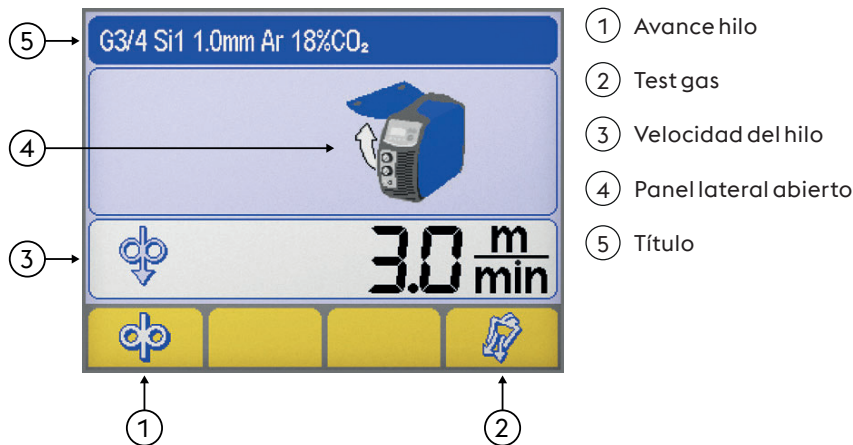

ES



Avance hilo

Permite el avance manual del alambre sin flujo de gas y sin el alambre bajo tensión. Permite la inserción del alambre en la cubierta de la antorcha durante las fases de preparación de la soldadura.



Test gas

Permite limpiar de impurezas el circuito del gas y realizar los ajustes preliminares apropiados de presión y de flujo del gas, sin activar el equipo.



Velocidad del hilo

Permite regular la velocidad de avance del hilo (durante la etapa de carga).

Mínimo	Máximo	Por defecto
0.5 m/min	22.0 m/min	3.0 m/min



Panel lateral abierto



Título

Permite visualizar la información más importante relativa al proceso seleccionado.

4.3 Pantalla principal

Permite la gestión del equipo y del proceso de soldadura, mostrando los ajustes principales.

4.4 Pantalla principal del proceso MMA

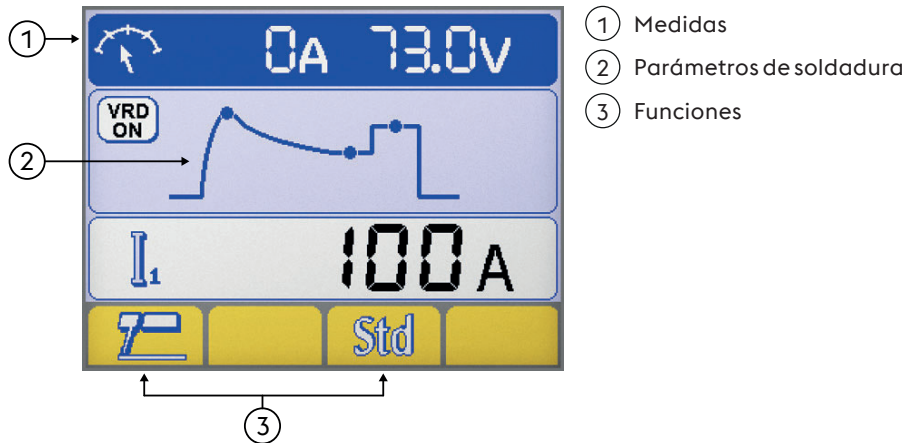

Medidas

Durante las fases de soldadura, se visualizan en la pantalla LCD los valores reales de corriente y de tensión.

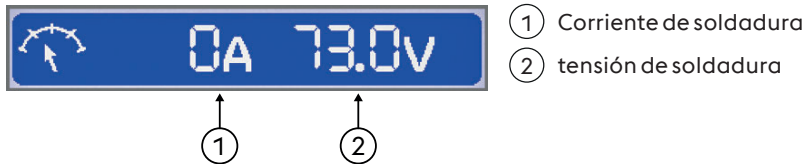

Parámetros de soldadura

► Seleccione el parámetro deseado pulsando la tecla encoder.

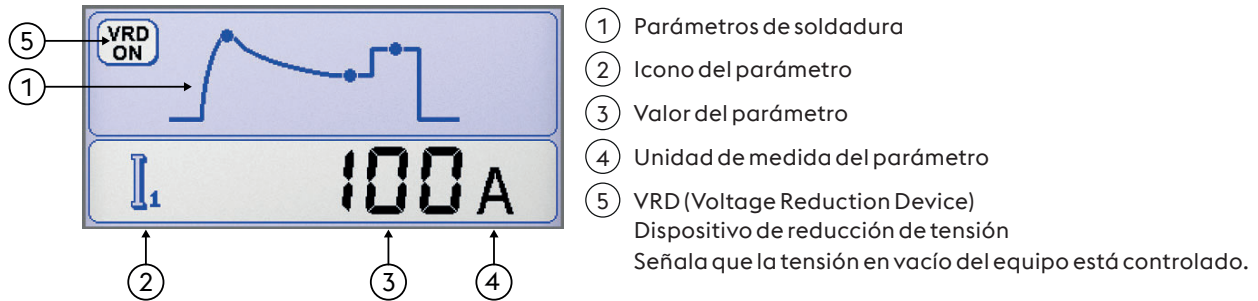

Funciones

Permiten el ajuste de las funciones de proceso y del modo de soldadura más importantes.



ES



Sinergia MMA

Permite configurar la mejor dinámica de arco seleccionando el tipo de electrodo utilizado.

Si selecciona una dinámica de arco correcta podrá aprovechar al máximo el equipo con el objetivo de obtener las mejores prestaciones posibles en soldadura.



No se garantiza una soldadura perfecta del electrodo utilizado.

La soldadura depende de la calidad de los consumibles y de su conservación, de los modos operativos y de las condiciones de soldadura, de las numerosas aplicaciones posibles...

4.5 Pantalla principal del proceso TIG

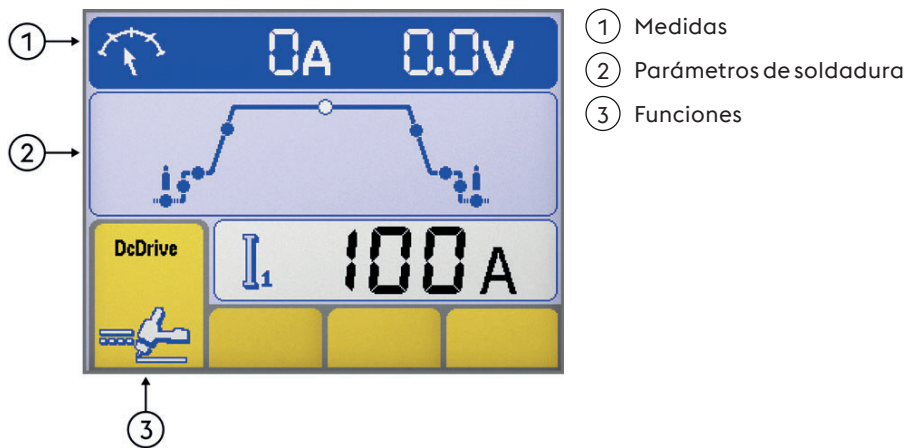

Medidas

Durante las fases de soldadura, se visualizan en la pantalla LCD los valores reales de corriente y de tensión.

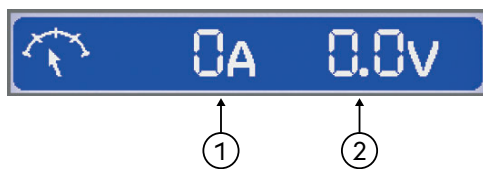

- ① Corriente de soldadura
- ② tensión de soldadura

Parámetros de soldadura

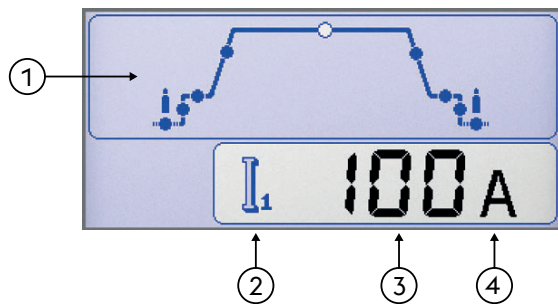

- ① Parámetros de soldadura
 - ▶ Seleccione el parámetro deseado pulsando la tecla encoder.
 - ▶ Regule el valor del parámetro seleccionado girando el encoder.
- ② Icono del parámetro
- ③ Valor del parámetro
- ④ Unidad de medida del parámetro

Funciones

Permiten el ajuste de las funciones de proceso y del modo de soldadura más importantes.

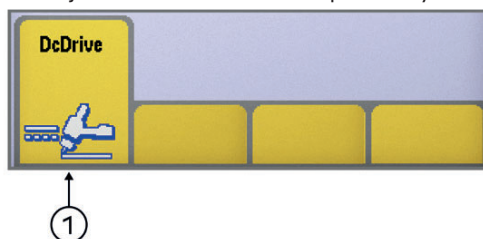

- ① Procédé de soudage



Procédé de soudage

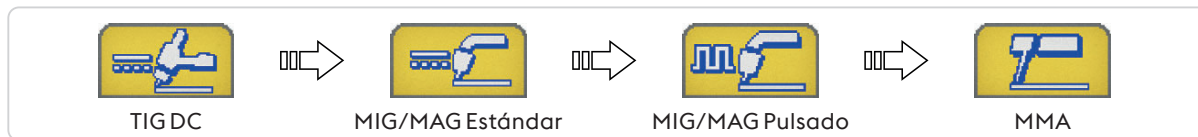

4.6 Pantalla principal del proceso MIG/MAG

Pantalla básica

① Título MIG/MAG
 ② Parámetros de soldadura
 ③ Funciones

Pantalla gráfica

① Título MIG/MAG
 ② Parámetros de soldadura
 ③ Funciones

Título MIG/MAG

Permite visualizar la información más importante relativa al proceso seleccionado.

G3/4 Si1 1.0mm Ar 18%CO₂

- ①
- ②
- ③

Curva sinérgica seleccionada

- ① Tipo de material de aportación
- ② Diámetro del alambre
- ③ Tipo de gas

I 118A 2.2mm 3.4mm V 19.5V

- ①
- ②
- ③
- ④

Parámetros de soldadura

- ① Corriente de soldadura
- ② Grosor de la pieza
- ③ Cordón angular
- ④ tensión de soldadura

ES

Parámetros de soldadura (Pantalla básica)

► Seleccione el parámetro deseado pulsando la tecla encoder.

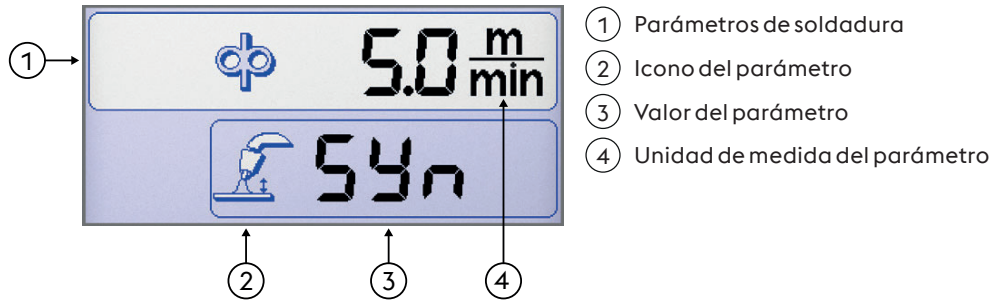

Parámetros de soldadura (Pantalla gráfica)

► Seleccione el parámetro deseado pulsando la tecla encoder.

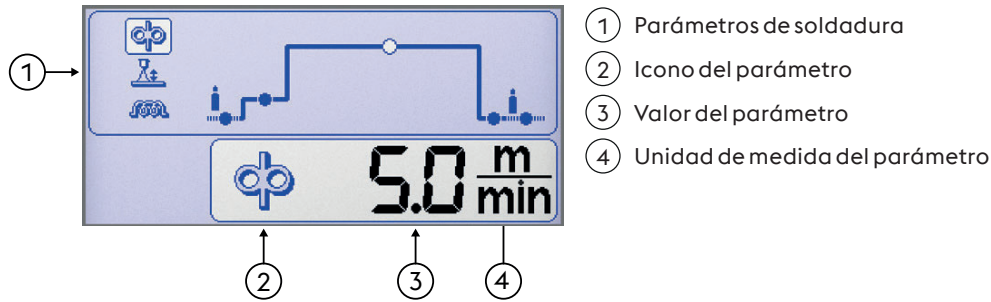

ES

Funciones

Permiten el ajuste de las funciones de proceso y del modo de soldadura más importantes.

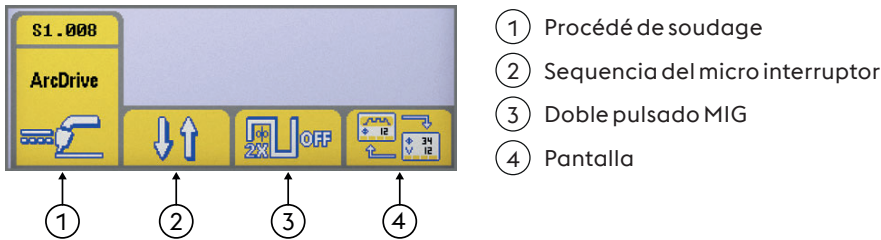

Procedé de soudage



Secuencia del micro interruptor

Permite seleccionar el modo de soldadura



2 Tiempos

En dos tiempos, al pulsar el botón el gas fluye, se suministra tensión al alambre y lo hace avanzar; al soltarlo, se desactivan el gas, la tensión y el avance del alambre.



4 Tiempos

En cuatro tiempos, la primera pulsación del botón hace que el gas fluya con un tiempo de pre-gas manual; al soltarlo, se activa la tensión del alambre y su avance. La siguiente presión del botón detiene el alambre y hace que se inicie el proceso final, que vuelve a llevar la corriente hasta cero; al soltar el botón por última vez se desactiva el flujo de gas.



Crater filler

Permite realizar una soldadura con tres niveles diferentes de potencia, que el soldador puede seleccionar y controlar directamente utilizando el botón de la antorcha.

Al pulsar el botón por primera vez el gas fluye, se activa la tensión del alambre y éste avanza a la velocidad establecida por el parámetro "incremento inicial" (durante la configuración) y con los valores sinérgicos relativos de los parámetros de soldadura.

Al soltar el botón de la antorcha, la velocidad del alambre y los parámetros sinérgicos relativos cambian automáticamente a los valores principales establecidos en el panel de control.

La siguiente presión del botón de la antorcha hace que la velocidad del alambre y los parámetros sinérgicos relativos vuelvan a los valores preestablecidos (durante la configuración) del parámetro de relleno de huecos.

Al soltar el botón de la antorcha se detiene el avance del alambre y se suministra alimentación para los tiempos de burn back y post-gas.



Doble pulsado MIG



Doble pulsación activado



Doble pulsación desactivado

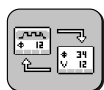

Pantalla

Permite el cambio de visualización entre:



Pantalla básica



Pantalla gráfica

Pantalla de curva sinérgica



Sinergia

Permite seleccionar un programa de soldadura predefinido (sinergia) mediante la selección de algunas informaciones sencillas

Selección del proceso de soldadura

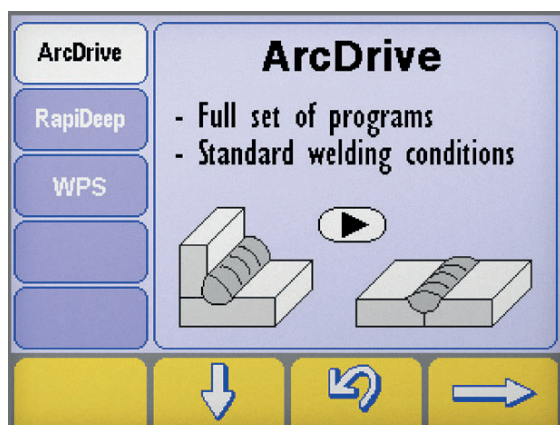

- ▶ Entre a la pantalla "sinergias" pulsando el botón durante al menos un segundo.
- ▶ Seleccione el proceso deseado pulsando los botones y .
- ▶ Pulse el botón para ir al siguiente paso.

ES



Procédez de soudage

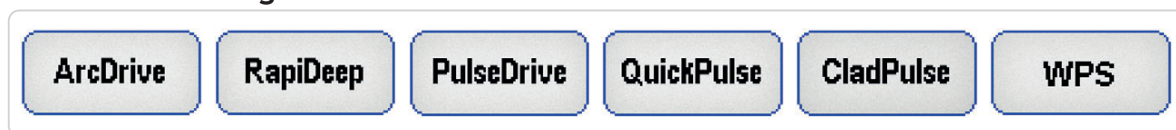

Pantalla de selección de sinergia Tipo de material/Tipo de gas

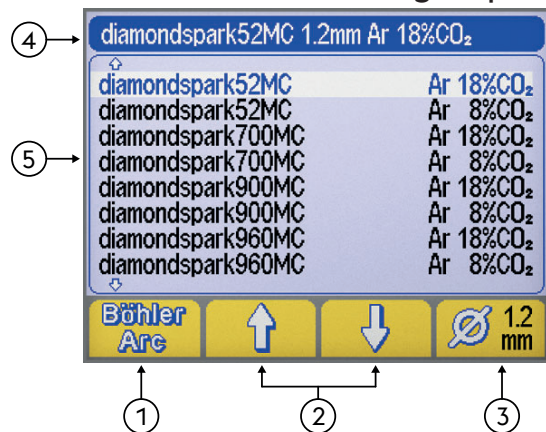

- Programa de soldadura (BöhlerArc/UniversalArc)
- Selección del material/gas
- Diámetro del alambre
- Título
- Programa de soldadura



Programa de soldadura

Permite seleccionar el programa de soldadura



BöhlerArc



UniversalArc



Selección del material/gas

Pulse la sección de:



• Tipo de material de aportación



• Tipo de gas



Diámetro del alambre

Permite la selección del diámetro del alambre utilizado (mm).

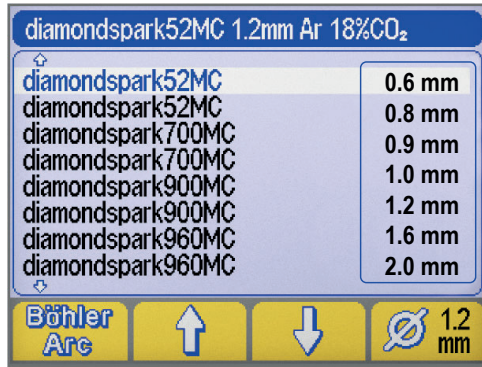

① Diámetro del alambre

①



Título

Permite visualizar la información más importante relativa al proceso seleccionado.



NO PROGRAM

Indica que la curva sinérgica seleccionada no está disponible o no es coherente con las demás configuraciones del equipo.

ES

4.7 Pantalla de programas



Permite memorizar y gestionar 240 programas de soldadura personalizables por el usuario.

Programas (JOB)

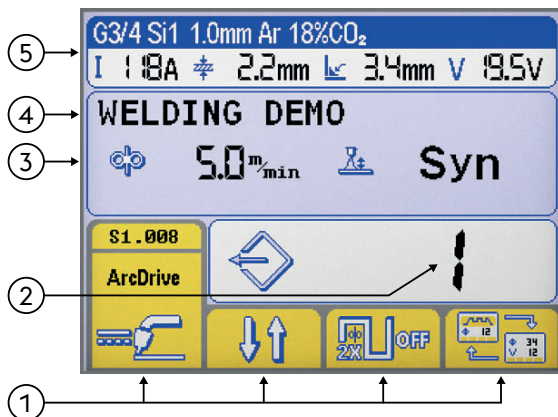

- ① Funciones
- ② Número del programa seleccionado
- ③ Parámetros principales del programa seleccionado
- ④ Descripción del programa seleccionado
- ⑤ Título

Consulte la sección "Pantalla principal"

Memorizar programas

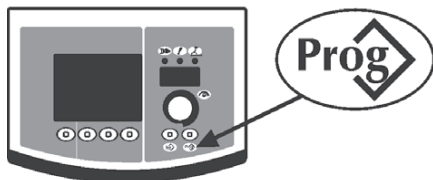

▶ Entre en la pantalla "memorización programa" pulsando la tecla **Prog** durante al menos un segundo.



▶ Seleccione el programa (o la memoria vacía) deseado girando el encoder.

--- Memoria vacía

Programa memorizado

▶ Anule la operación pulsando la tecla **Esc**.

▶ Guarde todos los ajustes actuales en el programa seleccionado pulsando la tecla **Save**.

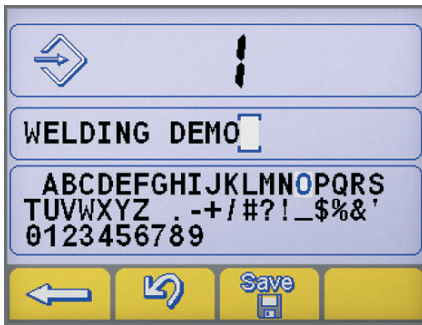

Introduzca una descripción del programa.

- ▶ Seleccione la letra deseada girando el encoder.
- ▶ Memorice la letra seleccionada pulsando el encoder.
- ▶ Cancele la última letra pulsando la tecla
- ▶ Anule la operación pulsando la tecla
- ▶ Anule la operación pulsando la tecla



La memorización de un nuevo programa en una memoria ya ocupada implica la cancelación de la memoria mediante un procedimiento obligatorio.



- ▶ Anule la operación pulsando la tecla
- ▶ Elimine el programa seleccionado pulsando la tecla
- ▶ Reanude el procedimiento de memorización.

Recuperar programas

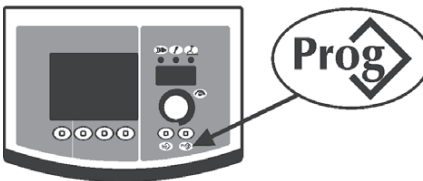

- ▶ Recupere el 1er programa disponible pulsando la tecla
- ▶ Seleccione el programa deseado girando el encoder.
- ▶ Seleccione el programa deseado pulsando la tecla



Se recupera sólo la memoria ocupada por un programa, mientras que las vacías se omiten automáticamente.

Cancelar programa



- ▶ Seleccione el programa deseado girando el encoder.
- ▶ Elimine el programa seleccionado pulsando la tecla
- ▶ Anule la operación pulsando la tecla



- ▶ Anule la operación pulsando la tecla
- ▶ Elimine el programa seleccionado pulsando la tecla

5. CONFIGURACIÓN

5.1 Configuración y ajuste de los parámetros

Permite la configuración y el ajuste de una serie de parámetros adicionales para garantizar un mejor y más preciso control del sistema de soldadura.

Los parámetros presentes en la configuración están organizados según el proceso de soldadura seleccionado y tienen una codificación numérica.

Entrada a la configuración

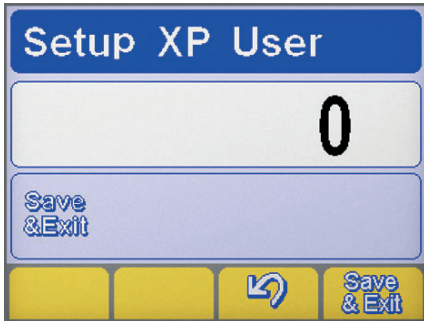

- ▶ Se produce pulsando durante 5 segundos la tecla encoder
- ▶ La entrada será confirmada con un 0 en la pantalla.

Selección y ajuste del parámetro deseado

- ▶ El parámetro se selecciona girando el encoder hasta visualizar el código numérico relativo al parámetro deseado.
- ▶ Si pulsa la tecla encoder en este momento, podrá ver y ajustar el valor definido para el parámetro seleccionado.

Salida de la "configuración"

- ▶ Para salir de la sección "ajuste", pulse nuevamente el encoder.
- ▶ Para salir de la configuración, pase al parámetro "0" (guardar y salir) y pulse la tecla encoder.
- ▶ Anule la operación pulsando la tecla .
- ▶ Para guardar la modificación y salir de la configuración, pulse el botón: .

5.1.1 Lista de los parámetros de la configuración (MMA)

0

Guardar y salir

Permite guardar las modificaciones y salir de la configuración.



1

Reset

Permite recuperar los valores por defecto de todos los parámetros.



3

Hot start

Permite ajustar el valor de hot start en MMA.

Permite un arranque más o menos "caliente" durante el cebado del arco, facilitando las operaciones de comienzo de la soldadura.



Electrodos básico

Mínimo	Máximo	Por defecto
0/off	500%	80%

Electrodos celulósico

Mínimo	Máximo	Por defecto
0/off	500%	150%

Electrodos CrNi

Mínimo	Máximo	Por defecto
0/off	500%	100%

Electrodos de aluminio

Mínimo	Máximo	Por defecto
0/off	500%	120%

Electrodos de hierro fundido

Mínimo	Máximo	Por defecto
0/off	500%	100%

7

Corriente de soldadura

Permite ajustar la corriente de soldadura.



Mínimo	Máximo	Por defecto
3 A	I _{max}	100 A

8 Arc force

Permite ajustar el valor del Arc force en MMA.

Permite una respuesta dinámica, más o menos energética, durante la soldadura facilitando el trabajo del soldador.

Aumentar el valor del Arc force para reducir los riesgos de adhesión del electrodo.

Electrodos básico

Mínimo	Máximo	Por defecto
0/off	500%	30%

Electrodos celulósico

Mínimo	Máximo	Por defecto
0/off	500%	350%

Electrodos CrNi

Mínimo	Máximo	Por defecto
0/off	500%	30%

Electrodos de aluminio

Mínimo	Máximo	Por defecto
0/off	500%	100%

Electrodos de hierro fundido

Mínimo	Máximo	Por defecto
0/off	500%	70%

204 Dynamic power control (DPC)

Permite la selección de la característica V/I deseada.

I=C Corriente constante

El aumento o la reducción de la altura del arco no tiene ninguna influencia sobre la corriente de soldadura generada.

Recomendado para electrodo: Básico, Rutilo, Ácido, Acero inox, Hierro colado

1:20 Característica declinante con regulación de rampa

El aumento de la altura del arco provoca la reducción de la corriente de soldadura (y viceversa) según el valor ajustado de 1 a 20 Amperios para cada Voltio.

Recomendado para electrodo: Celulosico, Aluminio

P=C Potencia constante

El aumento de la altura del arco provoca la reducción de la corriente de soldadura (y viceversa) según la fórmula $V \cdot I = K$

Recomendado para electrodo: Celulosico, Aluminio

312 Tensión de desprendimiento del arco

Permite ajustar el valor de tensión al que se fuerza la desactivación del arco eléctrico.

Permite una gestión mejorada de las diferentes condiciones de funcionamiento que se crean.

Por ejemplo, durante la soldadura por puntos, una baja tensión de desprendimiento del arco reduce las llamas al alejarse el electrodo de la pieza reduciendo las salpicaduras, quemaduras y la oxidación de la pieza.

Si utiliza electrodos que exigen altas tensiones, se aconseja ajustar un umbral alto para evitar que el arco de soldadura se desactive durante la soldadura.



Nunca ajuste una tensión de desprendimiento del arco mayor que la tensión en vacío de la fuente de alimentación.

Electrodos básico

Mínimo	Máximo	Por defecto
0/off	99.9 V	57.0 V

Electrodos celulósico

Mínimo	Máximo	Por defecto
0/off	99.9 V	70.0 V

399 Velocidad de desplazamiento

Permite configurar la velocidad de ejecución de la soldadura.

Default cm/min: velocidad de referencia para la soldadura manual.

Syn: valor sinérgico.

Mínimo	Máximo	Por defecto
1 cm/min	200 cm/min	15 cm/min

500 Configuración de la máquina

Permite seleccionar el interface gráfico deseado.

Permite acceder a los niveles superiores de la configuración.

Consulte la sección "Personalizar el interfaz (Set up 500)"

Valeur	Interfaz Usuario
XE	Modo Easy
XA	Modo Advanced
XP	Modo Professional

Valeur	Nivel seleccionado
USER	Usuario
SERV	Service
vaBW	vaBW

551 Lock/unlock



Permite bloquear los comandos del panel e introducir un código de protección. Consulte la sección "Lock/unlock (Set up 551)".

552 Tono zumbador



Permite ajustar el tono del zumbador.

Mínimo	Máximo	Por defecto
0/off	10	10

601 Paso de regulación



Permite regular un parámetro con paso personalizable del operario.

Mínimo	Máximo	Por defecto
1	Imax	1

602 Parámetro externo CH1, CH2, CH3, CH4



Permite la gestión del parámetro externo 1, 2, 3, 4 (valor mínimo, valor máximo, valor por defecto, parámetro seleccionado).

Consulte la sección "Gestión de comandos externos (Set up 602)".

705 Ajuste resistencia del circuito



Permite ajustar el equipo.

Consulte la sección "Ajuste resistencia del circuito (set up 705)".

751 Lectura de corriente



Permite visualizar el valor real de la corriente de soldadura.

752 Lectura de tensión



Permite visualizar el valor real de la tensión de soldadura.

768 Medición del aporte térmico HI



Permite leer el valor de la medida del aporte térmico en la soldadura.

5.1.2 Lista de los parámetros de configuración (TIG)

0 Guardar y salir



Permite guardar las modificaciones y salir de la configuración.

1 Reset



Permite recuperar los valores por defecto de todos los parámetros.

7 Corriente de soldadura



Permite ajustar la corriente de soldadura.

Mínimo	Máximo	Por defecto
3 A	Imax	100 A

399 Velocidad de desplazamiento



Permite configurar la velocidad de ejecución de la soldadura.

Default cm/min: velocidad de referencia para la soldadura manual.

Syn: valor sinérgico.

Mínimo	Máximo	Por defecto
1 cm/min	200 cm/min	10 cm/min

500 Configuración de la máquina

Permite seleccionar el interface gráfico deseado.
Permite acceder a los niveles superiores de la configuración.
Consulte la sección "Personalizar el interfaz (Set up 500)"

Valeur	Interfaz Usuario
XE	Modo Easy
XA	Modo Advanced
XP	Modo Professional

Valeur	Nivel seleccionado
USER	Usuario
SERV	Service
vaBW	vaBW

551 Lock/unlock

Permite bloquear los comandos del panel e introducir un código de protección.
Consulte la sección "Lock/unlock (Set up 551)".

552 Tono zumbador

Permite ajustar el tono del zumbador.

Mínimo	Máximo	Por defecto
0/off	10	10

601 Paso de regulación

Permite regular un parámetro con paso personalizable del operario.

Mínimo	Máximo	Por defecto
1	Imax	1

602 Parámetro externo CH1, CH2, CH3, CH4

Permite la gestión del parámetro externo 1, 2, 3, 4 (valor mínimo, valor máximo, valor por defecto, parámetro seleccionado).

Consulte la sección "Gestión de comandos externos (Set up 602)".

705 Ajuste resistencia del circuito

Permite ajustar el equipo.

Consulte la sección "Ajuste resistencia del circuito (set up 705)".

751 Lectura de corriente

Permite visualizar el valor real de la corriente de soldadura.

752 Lectura de tensión

Permite visualizar el valor real de la tensión de soldadura.

755 Lectura de capacidad del gas (WFR)

Permite visualizar el valor real del flujo de gas.

757 Lectura de la velocidad del alambre

Lectura encoder motor 1.

760 Lectura de corriente (motor 1)

Permite visualizar el valor real de la corriente (motor 1).

764 Lectura del flujo del líquido refrigerante

Permite visualizar el valor del líquido refrigerante.

765 Lectura de temperatura del líquido refrigerante



Permite visualizar el valor real de la temperatura del líquido refrigerante.

768 Medición del aporte térmico HI



Permite leer el valor de la medida del aporte térmico en la soldadura.

801 Límites de seguridad



Permite ajustar los límites de atención y los límites de seguridad.

Permite controlar el proceso de soldadura ajustando en los principales parámetros mensurables límites de atención y límites de seguridad.

Permite un control preciso de las distintas fases de soldadura.

Consulte la sección "Límites de seguridad (Set up 801)".

5.1.3 Lista de los parámetros de la configuración (MIG/MAG)

0 Guardar y salir



Permite guardar las modificaciones y salir de la configuración.

1 Reset



Permite recuperar los valores por defecto de todos los parámetros.

2 Sinergia



MIG/MAG Estándar:

Permite la selección del proceso de MIG manual (Off) o de MIG sinérgico () especificando el tipo de material a soldar.

MIG/MAG Pulsado:

Permite la selección del proceso de MIG sinérgico () especificando el tipo de material a soldar.
Permite la selección del proceso de CC/CV.

3 Velocidad del hilo



Permite regular la velocidad de avance del hilo.

Mínimo	Máximo	Por defecto
0.5 m/min	22.0 m/min	-

4 Corriente



Permite ajustar la corriente de soldadura.

Mínimo	Máximo
3 A	I _{max}

5 Grosor de la pieza



Permite ajustar el espesor de la pieza a soldar.

Permite ajustar el equipo mediante la regulación de la pieza a soldar.

6 Cordón angular "a"



Permite configurar la profundidad del cordón en una unión angular.

7 Tensión - longitud de arco

Permite regular la tensión del arco.
Permite regular la longitud del arco en soldadura.

Tensión alta = arco largo

Tensión baja = arco corto

Modalidad manual

Mínimo	Máximo	Por defecto
5.0 V	55.5 V	5.0 V

10 Pre gas

Permite ajustar y regular el flujo de gas antes del cebado del arco.
Permite la salida del gas en la antorcha y la preparación del ambiente entorno para la soldadura.

Mínimo	Máximo	Por defecto
0/off	99.9 s	0.1 s

11 Soft start



Permite el ajuste de la velocidad de avance del alambre durante las fases cebado del arco.
Permite un cebado a velocidad reducida y por tanto más suave y con menos salpicaduras.

Mínimo	Máximo	Por defecto
10 %	100 %	50 %

12 Rampa del motor

Permite configurar un paso gradual entre la velocidad del alambre de cebado y la de soldadura.

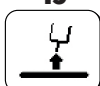
Mínimo	Máximo	Por defecto
0/off	1.0 s	0/off

15 Burn back

Permite el ajuste del tiempo de salida del alambre impidiendo que se pegue al final de la soldadura.
Permite ajustar la longitud del trozo de alambre externo a la antorcha.

Mínimo	Máximo	Por defecto
-2.00	+2.00	0/syn

16 Post-gas

Permite ajustar el flujo de gas al final de la soldadura.

Mínimo	Máximo	Por defecto
0/off	99.9 s	2.0 s

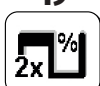
19 Duty cycle (doble pulsado)

Permite regular el duty cycle en doble pulsado.

Mínimo	Máximo	Por defecto
10 %	90 %	50 %

20 Doble pulsación

Permite regular la amplitud de la pulsación.

Mínimo	Máximo	Por defecto
0 %	100 %	±25 %

Mínimo	Máximo	Por defecto
0.5 m/min	22 m/min	2.5 m/min

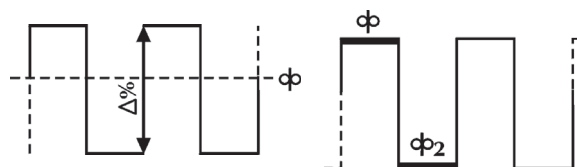
21 Frecuencia de impulsos (doble pulsado)

Permite regular el periodo, es decir, el ciclo de repetición de la pulsación.
Permite regular la frecuencia del impulso.

Mínimo	Máximo	Por defecto
0.1 Hz	5.0 Hz	2.0 Hz

ES

22 Tensión secundaria (doble pulsado)



Permite regular la tensión del nivel de pulsación secundaria.
Permite obtener mayor estabilidad del arco en las distintas fases de pulsación.

Mínimo	Máximo	Por defecto
-5.0	+5.0	0/syn

23 Rampas de impulsos (doble pulsado)



Permite ajustar un tiempo de rampa en la fase de pulsación.

Mínimo	Máximo	Por defecto
1 %	100 %	50 %

24 Bilevel (4T - crater filler)



Permite ajustar la velocidad del hilo secundaria en el modo de soldadura Bilevel.

Si el soldador aprieta y suelta rápidamente el pulsador se pasa a “φ₂”.
Volviendo a apretar y soltar rápidamente el pulsador, se pasa a “φ” y así sucesivamente.

Mínimo	Máximo	Por defecto
1 %	200 %	0/off

25 Incremento inicial



Permite regular el valor de la velocidad del hilo durante la primera fase de soldadura del "crater-filler".
Permite incrementar la energía transmitida a la pieza en la fase en la que el material (todavía frío) necesita más calor para fundir de forma homogénea.

Mínimo	Máximo	Por defecto
20 %	200 %	120 %

26 Crater filler



Permite regular el valor de la velocidad del hilo durante la fase de finalización de la soldadura.
Permite reducir la energía transmitida a la pieza en la fase en la que el material ya está muy caliente, reduciendo los riesgos de deformaciones innecesarias.

Mínimo	Máximo	Por defecto
20 %	200 %	80 %

27 Temporización incremento inicial



Permite configurar el tiempo de incremento inicial.
Permite automatizar la función "crater filler".

Mínimo	Máximo	Por defecto
0.1 s	99.9 s	0/off

28 Temporización crater filler



Permite configurar el tiempo de "crater filler".
Permite automatizar la función "crater filler".

Mínimo	Máximo	Por defecto
0.1 s	99.9 s	0/off

30 Soldadura por puntos

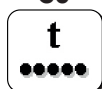

Permite activar el proceso de "soldadura por puntos" y establecer el tiempo de soldadura.

Mínimo	Máximo	Por defecto
0.1 s	99.9 s	0/off

31 Punto pausa

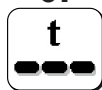

Permite habilitar el proceso de "punto de pausa" y establecer el tiempo de parada entre una soldadura y otra.

Mínimo	Máximo	Por defecto
0.1 s	99.9 s	0/off

32 Tensión secundaria (Bilevel MIG)

Permite regular la tensión del nivel de pulsación secundaria.
Permite obtener mayor estabilidad del arco en las distintas fases de pulsación.

Mínimo	Máximo	Por defecto
-5.0	+5.0	0/syn

33 Inductancia secundaria (Bilevel MIG)

Permite regular la inductancia del nivel de pulsación secundaria.
Permite obtener un arco relativamente rápido en la compensación de los movimientos del soldador y de la inestabilidad natural de la soldadura.

Inductancia baja = arco reactivo (más salpicaduras).
Inductancia alta = arco poco reactivo (menos salpicaduras).

Mínimo	Máximo	Por defecto
-30	+30	0/syn

34 Rampa de aumento inicial

Permite configurar un paso gradual entre el aumento inicial y la soldadura.

Mínimo	Máximo	Por defecto
0 s	10 s	0/off

35 Rampa crater filler

Permite configurar un paso gradual entre la soldadura y el crater filler.

Mínimo	Máximo	Por defecto
0 s	10 s	0/off

202 Inductancia

Permite una regulación electrónica de la inductancia serie del circuito de soldadura.
Permite obtener un arco relativamente rápido en la compensación de los movimientos del soldador y de la inestabilidad natural de la soldadura.

Inductancia baja = arco reactivo (más salpicaduras).
Inductancia alta = arco poco reactivo (menos salpicaduras).

Mínimo	Máximo	Por defecto
-30	+30	0/syn

331 Tensión media compensada

Permite configurar la tensión de soldadura.

399 Velocidad de desplazamiento

Permite configurar la velocidad de ejecución de la soldadura.
Default cm/min: velocidad de referencia para la soldadura manual.
Syn: valor sinérgico.

Mínimo	Máximo	Por defecto
syn min	syn max	35 cm/min

500 Configuración de la máquina

Permite seleccionar el interface gráfico deseado.
Permite acceder a los niveles superiores de la configuración.
Consulte la sección "Personalizar el interfaz (Set up 500)"

Valeur	Interfaz Usuario	Valeur	Nivel seleccionado
XE	Modo Easy	USER	Usuario
XA	Modo Advanced	SERV	Service
XP	Modo Professional	vaBW	vaBW

551 Lock/unlock

Permite bloquear los comandos del panel e introducir un código de protección.
Consulte la sección "Lock/unlock (Set up 551)".

ES

552 Tono zumbador



Permite ajustar el tono del zumbador.

Mínimo	Máximo	Por defecto
0/off	10	10

601 Paso de regulación



Permite regular un parámetro con paso personalizable del operario. Funcionalidad controlada por botón antorcha arriba / abajo.

Mínimo	Máximo	Por defecto
1	Imax	1

602 Parámetro externo CH1, CH2, CH3, CH4



Permite la gestión del parámetro externo 1, 2, 3, 4 (valor mínimo, valor máximo, valor por defecto, parámetro seleccionado).

Consulte la sección "Gestión de comandos externos (Set up 602)".

606 Antorcha U/D



Permite la gestión del parámetro externo (U/D).

Valeur	Por defecto	Función de devolución de llamada
0/off	-	off
1/I1	X	Corriente
	-	Recuperar programas

705 Ajuste resistencia del circuito



Permite ajustar el equipo.

Consulte la sección "Ajuste resistencia del circuito (set up 705)".

751 Lectura de corriente



Permite visualizar el valor real de la corriente de soldadura.

752 Lectura de tensión



Permite visualizar el valor real de la tensión de soldadura.

755 Lectura de capacidad del gas (WFR)



Permite visualizar el valor real del flujo de gas.

757 Lectura de la velocidad del alambre



Lectura encoder motor 1.

758 Velocidad de desplazamiento del robot



Permite visualizar la velocidad de desplazamiento del brazo de un robot o de una automatización.

760 Lectura de corriente (motor 1)



Permite visualizar el valor real de la corriente (motor 1).

761 Lectura de la velocidad del alambre



Lectura encoder motor 2.

762 Lectura de corriente (motor 2)
Permite visualizar el valor real de la corriente (motor 2).



763 Lectura de la velocidad del alambre
Lectura real de avance del hilo.



764 Lectura del flujo del líquido refrigerante
Permite visualizar el valor del líquido refrigerante.



765 Lectura de temperatura del líquido refrigerante
Permite visualizar el valor real de la temperatura del líquido refrigerante.



768 Medición del aporte térmico HI
Permite leer el valor de la medida del aporte térmico en la soldadura.



801 Límites de seguridad
Permite ajustar los límites de atención y los límites de seguridad.
Permite controlar el proceso de soldadura ajustando en los principales parámetros mensurables límites de atención y límites de seguridad.
Permite un control preciso de las distintas fases de soldadura.
Consulte la sección "Límites de seguridad (Set up 801)".



5.2 Procedimientos específicos de uso de los parámetros

5.2.1 Personalizar pantalla 7 segmentos

Permite visualizar constantemente el valor de un parámetro en la pantalla de 7 segmentos.

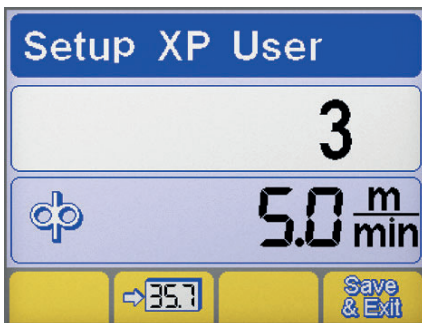

- ▶ Entre en la configuración pulsando la tecla encoder durante al menos 5 segundos.
- ▶ Seleccione el parámetro deseado girando el encoder.
- ▶ Memorice el parámetro seleccionado en la pantalla de 7 segmentos pulsando la tecla **35.7**.
- ▶ Guarde y salga de la pantalla actual pulsando la tecla **Save**.

5.2.2 Personalizar el interfaz (Set up 500)

Permite personalizar los parámetros en la pantalla principal.

500 Configuración de la máquina
Permite seleccionar el interface gráfico deseado.



Valeur	Interfaz Usuario
XE	Modo Easy
XA	Modo Advanced
XP	Modo Professional

MODALIDAD XE

MMA

Parámetros de soldadura



TIG

Parámetros de soldadura

Funciones

MIG/MAG

Parámetros de soldadura

Funciones

MODALIDAD XA

MMA

Parámetros de soldadura

Funciones

TIG

Parámetros de soldadura

Funciones

MIG/MAG

Parámetros de soldadura

Funciones

MODALIDAD XP

MMA

Parámetros de soldadura

Funciones

TIG

Parámetros de soldadura

Funciones

MIG/MAG

Parámetros de soldadura

Funciones

ES

5.2.3 Lock/unlock (Set up 551)

Permite bloquear los comandos del panel e introducir un código de protección.

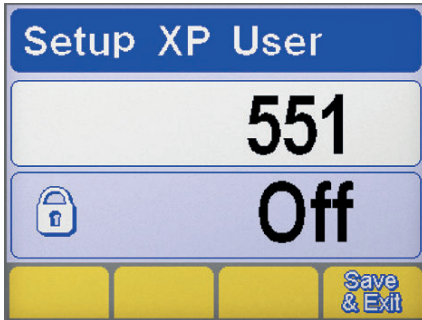

Selección parámetro

- ▶ Entre en la configuración pulsando la tecla encoder durante al menos 5 segundos.
- ▶ Seleccione el parámetro deseado (551).
- ▶ Active la regulación del parámetro seleccionado pulsando la tecla encoder.

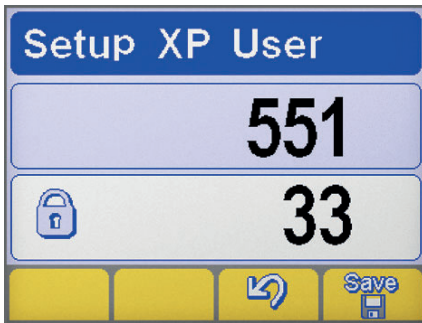

- ▶ Ajuste una codificación numérica (contraseña) girando el encoder.
- ▶ Confirme la operación pulsando el botón encoder.
- ▶ Anule la operación pulsando la tecla .
- ▶ Para guardar la modificación, pulse el botón: .

Funciones del panel



Al ejecutar cualquier operación en un panel de comandos bloqueado, aparecerá una pantalla especial.

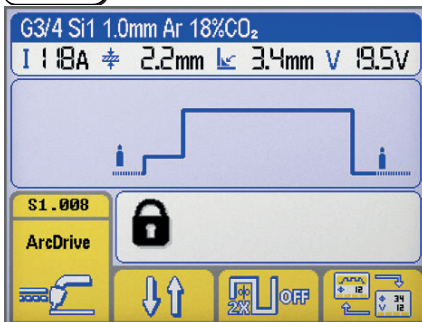

- ▶ Acceda temporalmente (5 minutos) a las funciones del panel girando el encoder e introduciendo el código numérico correcto.
- ▶ Confirme la operación pulsando el botón encoder.
- ▶ Puede desbloquear definitivamente el panel de comandos entrando en la configuración (siga las indicaciones descritas anteriormente) y reajustando el parámetro 551 a "off".
- ▶ Confirme la operación pulsando el botón encoder.
- ▶ Para guardar la modificación, pulse el botón: .

5.2.4 Gestión de comandos externos (Set up 602)

Permite la gestión del parámetro externo 2 (valor mínimo, valor máximo, valor por defecto, parámetro seleccionado).

Selección parámetro



- ▶ Entre en la configuración pulsando la tecla encoder durante al menos 5 segundos.
- ▶ Seleccione el parámetro deseado (602).
- ▶ Entre en la pantalla "Gestión de comandos externos" pulsando la tecla encoder.

Gestión de comandos externos

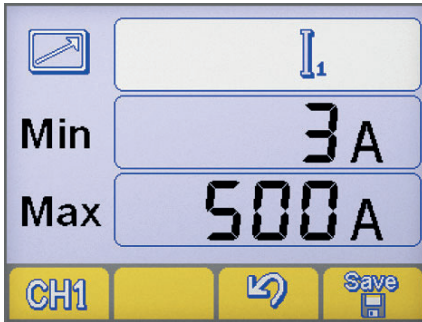

- ▶ Seleccione la salida de control RC deseada (CH1, CH2, CH3, CH4) pulsando la tecla. **CH1**
- ▶ Seleccione el parámetro deseado (Mín.-Máx.-parámetro) pulsando la tecla encoder.
- ▶ Regule el parámetro deseado (Mín.-Máx.-parámetro) girando el encoder.
- ▶ Para guardar la modificación, pulse el botón: **Save**.
- ▶ Anule la operación pulsando la tecla **Esc**.

5.2.5 Ajuste resistencia del circuito (set up 705)

Permite ajustar el generador en la resistencia del circuito de soldadura actual.

Selección parámetro

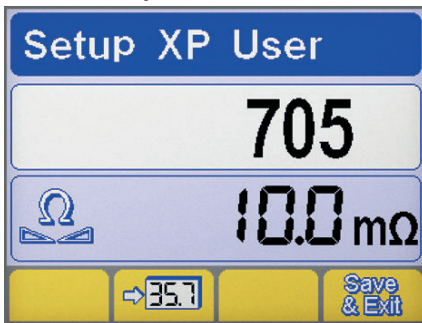

- ▶ Entre en la configuración pulsando la tecla encoder durante al menos 5 segundos.
- ▶ Seleccione el parámetro deseado (705).
- ▶ Active la regulación del parámetro seleccionado pulsando la tecla encoder.
- ▶ Conecte el generador al circuito de soldadura (banco o pieza).
- ▶ Retire la tobera para colocar la punta de contacto expuesta de la antorcha. (MIG/MAG)

ES

Pantalla de "INFO"

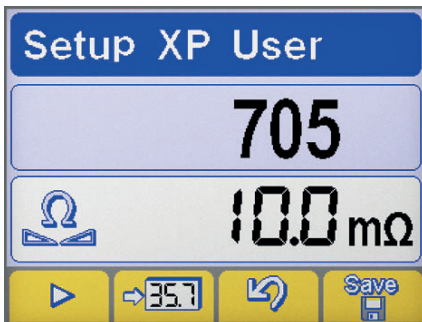

- ▶ Ponga en contacto eléctrico la punta del guía-hilo y la pieza a soldar. (MIG/MAG)
- ▶ Pulse el botón **▶** para iniciar el procedimiento.
- ▶ Mantenga el contacto durante al menos un segundo.
- ▶ El valor que se visualiza en la pantalla se actualizará cuando se complete el ajuste.
- ▶ Anule la operación pulsando la tecla **Save**.
- ▶ Anule la operación pulsando la tecla **Esc**.
- ▶ Para guardar la modificación y salir de la configuración, pulse el botón: **Save & Exit**.

5.2.6 Límites de seguridad (Set up 801)

Permite ajustar los límites de atención y los límites de seguridad.

Permite controlar el proceso de soldadura ajustando en los principales parámetros mensurables límites de atención y límites de seguridad.

Permite un control preciso de las distintas fases de soldadura.



Corriente de soldadura



tensión de soldadura



Lectura de capacidad del gas



Velocidad de desplazamiento del robot



Lectura de corriente (motor 1)



Lectura de corriente (motor 2)



Lectura del flujo del líquido refrigerante



Lectura de la velocidad del alambre



Lectura de temperatura del líquido refrigerante

Selección parámetro

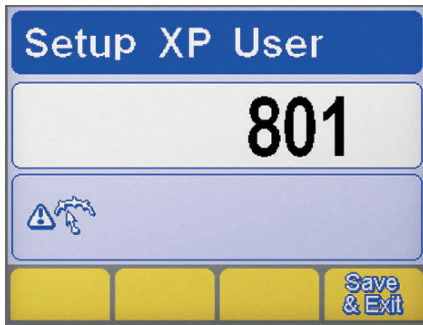

- ▶ Entre en la configuración pulsando la tecla encoder durante al menos 5 segundos.
- ▶ Seleccione el parámetro deseado (801).
- ▶ Entre en la pantalla "Límites de seguridad" pulsando la tecla encoder.

Selección del parámetro

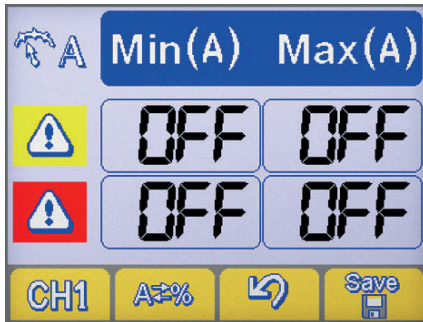

- ▶ Seleccione el parámetro deseado pulsando la tecla **CH1**.
- ▶ Seleccione el modo de ajuste de los límites de seguridad pulsando la tecla **A=%**.

A=% Configuración de la máquina

A/V Valor absoluto

% Valor porcentual

Configuración límites de protección

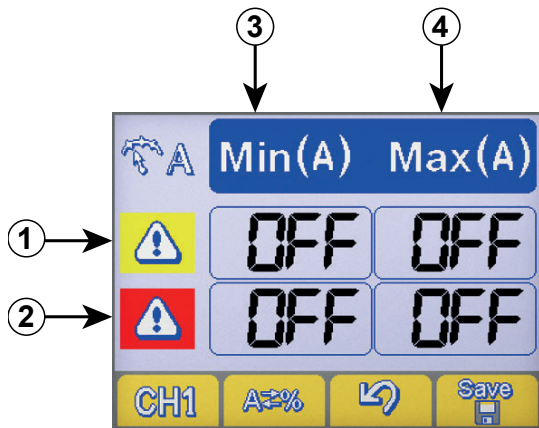

- ① Línea de los límites de atención
- ② Línea de los límites de alarma
- ③ Columna de los niveles mínimos
- ④ Columna de los niveles máximos

- ▶ Seleccione la casilla deseada pulsando la tecla encoder (la casilla seleccionada se visualiza con contraste invertido).
- ▶ Regule el nivel del límite seleccionado girando el encoder.
- ▶ Para guardar la modificación, pulse el botón: **Save**.



- Si supera uno de los límites de atención, se visualizará una señal en el panel de comandos.
- Si supera uno de los límites de alarma, se visualizará una señal en el panel de comandos y se bloquearán inmediatamente las operaciones de soldadura.
- Es posible ajustar los filtros de inicio y finalización de la soldadura para evitar señales de error en las fases de inicio y fin del arco (consulte la sección "Configuración" - Parámetros 802-803-804).

6. MANTENIMIENTO



Efectúe el mantenimiento ordinario del equipo según las indicaciones del fabricante. Cuando el equipo esté funcionando, todas las puertas de acceso y de servicio y las tapas tienen que estar cerradas y fijadas perfectamente. El equipo no debe ser modificado. Procure que no se forme polvo metálico en proximidad y cerca o encima de las aletas de ventilación.



El mantenimiento debe efectuarlo personal cualificado. La reparación o la sustitución de componentes del sistema por parte de personal no autorizado provoca la caducidad inmediata de la garantía del producto. La reparación o sustitución de componentes del equipo debe ser hecha realizarla personal técnico cualificado.



¡Antes de cada operación, desconecte el equipo!

6.1 Controles periódicos de la fuente de alimentación

6.1.1 Equipo



Limpie el interior con aire comprimido a baja presión y con pinceles de cerdas suaves. Compruebe las conexiones eléctricas y todos los cables de conexión.

6.1.2 Para el mantenimiento o la sustitución de los componentes de las antorchas, de la pinza portaelectrodo y/o de los cables de masa:



Controle la temperatura de los componentes y compruebe que no estén sobrecalentados.



Utilice siempre guantes conformes a las normativas.



Use llaves y herramientas adecuadas.

6.2 Responsabilidad



La carencia de este mantenimiento, provocará la caducidad de todas las garantías y el fabricante se considerará exento de toda responsabilidad. Si el operador no respetara las instrucciones descritas, el fabricante declina cualquier responsabilidad. Si tuviera dudas y/o problemas no dude en consultar al centro de asistencia técnica más cercano.

7. CODIFICACIÓN DE ALARMAS



ALARMA

La activación de una alarma o la superación de un límite de seguridad crítico provoca una señal visual en el panel de mandos y el bloqueo inmediato de las operaciones de soldadura.



ATENCIÓN

La activación de una alarma o la superación de un límite de seguridad crítico provoca una señal visual en el panel de mandos y el bloqueo inmediato de las operaciones de soldadura.

A continuación se enumeran todas las alarmas y todos los límites de protección relativos al sistema.

	E01 Exceso de temperatura	
--	---------------------------	--

	E02 Exceso de temperatura	
--	---------------------------	--

	E03 Exceso de temperatura	
--	---------------------------	--

	E05 Sobrecorriente	
--	--------------------	--

	E06 Sobrecorriente módulo de potencia (Boost)	
--	---	--

	E07 Fallo del sistema de alimentación del motor del alimentador de alambre	
--	--	--

	E08 Moteur bloqué	
--	-------------------	--

	E10 Sobrecorriente módulo de potencia (Inverter)	
--	--	--

 E11	Error de configuración del sistema		 E12	Error de comunicación (WF - DSP)	
 E13	Error de comunicación		 E14	Programa no válido	
 E15	Programa no válido		 E16	Error de comunicación (RI) (Automatización y robótica)	
 E17	Error de comunicación (μ P-DSP)		 E18	Programa no válido	
 E19	Error de configuración del sistema		 E20	Memoria averiada	
 E21	Pérdida de datos		 E22	Error de comunicación (DSP)	
 E29	Medidas incompatibles		 E30	Error de comunicación (H.F.)	
 E32	Pérdida de datos		 E38	Subtensión	
 E39	Fallo alimentación del equipo		 E40	Fallo alimentación del equipo	
 E43	Falta líquido refrigerante		 E48	Falta alambre (Automatización y robótica)	
 E49	Interruptor de emergencia (Automatización y robótica)		 E50	Alambre pegado (Automatización y robótica)	
 E51	Configuraciones no admitidas (Automatización y robótica)		 E52	Anticolisión (Automatización y robótica)	
 E53	Error interruptor de flujo externo (Automatización y robótica)		 E54	Superado el nivel de corriente (Límite inferior)	
 E55	Superado el nivel de corriente (Límite superior)		 E56	Superado el nivel de tensión (Límite inferior)	
 E57	Superado el nivel de tensión (Límite superior)		 E60	Superado el límite de velocidad (Límite inferior)	
 E61	Superado el límite de velocidad (Límite superior)		 E62	Superado el nivel de corriente (Límite inferior)	
 E63	Superado el nivel de corriente (Límite superior)		 E64	Superado el nivel de tensión (Límite inferior)	

	Superado el nivel de tensión (Límite superior)			Superado el límite de velocidad (Límite inferior)	
	Superado el límite de velocidad (Límite superior)			Límites de protección configurados no compatibles	
	Sobretensión líquido refrigerante			Sobrecorriente motor push-pull	
	Superado el límite de velocidad del alambre (speed meter)			Superado el nivel de corriente motor 1	
	Superado el nivel de corriente motor 2			Superado el nivel de flujo líquido refrigerante	
	Nivel de temperatura líquido refrigerante			Mantenimiento activo (Automatización y robótica)	

8. DIAGNÓSTICO Y SOLUCIÓN DE PROBLEMAS

El sistema no se activa (led verde apagado)

Causa

- » No hay tensión de red en la toma de alimentación.
- » Enchufe o cable de alimentación averiado.
- » Fusible de línea quemado.
- » Conmutador de alimentación averiado.
- » Conexión tras el carro de la bobina y generador no correcto o defectuoso.
- » Electrónica averiada.

Solución

- » Compruebe y repare la instalación eléctrica.
- » Consulte con personal experto.
- » Sustituya el componente averiado.
- » Contacte con el centro de asistencia más cercano para la reparación del sistema.
- » Sustituya el componente averiado.
- » Sustituya el componente averiado.
- » Contacte con el centro de asistencia más cercano para la reparación del sistema.
- » Verificar las correctas conexiones de los distintos elementos del equipo.
- » Contacte con el centro de asistencia más cercano para la reparación del sistema.

Falta de potencia de salida (el sistema no suelda)

Causa

- » Botón de la antorcha averiado.
- » Equipo sobrecalentado (alarma de temperatura - led amarillo iluminado).
- » Tapa lateral abierta o conmutador de la puerta averiado.
- » Conexión de masa incorrecta.
- » Tensión de red fuera de rango (led amarillo iluminado).
- » Electrónica averiada.

Solución

- » Sustituya el componente averiado.
- » Contacte con el centro de asistencia más cercano para la reparación del sistema.
- » Espere a que se enfríe el sistema desactivarlo.
- » Para la seguridad del operador la tapa lateral debe estar cerrada durante la soldadura.
- » Sustituya el componente averiado.
- » Contacte con el centro de asistencia más cercano para la reparación del sistema.
- » Conecte correctamente la masa.
- » Consulte el párrafo "Instalación".
- » Restablezca la tensión de red dentro del campo de la fuente de alimentación.
- » Conecte correctamente el equipo.
- » Consulte el párrafo "Conexiones".
- » Contacte con el centro de asistencia más cercano para la reparación del sistema.

Suministro de potencia incorrecto

Causa	Solución
» Selección incorrecta del proceso de soldadura o selector averiado.	» Seleccione correctamente el proceso de soldadura. » Sustituya el componente averiado. » Contacte con el centro de asistencia más cercano para la reparación del sistema.
» Configuraciones incorrectas de los parámetros y de las funciones de la instalación.	» Reinicie el sistema y vuelva a configurar los parámetros de soldadura.
» Potenciómetro/encoder para el ajuste de la corriente de soldadura averiado.	» Sustituya el componente averiado. » Contacte con el centro de asistencia más cercano para la reparación del sistema.
» Tensión de red fuera de rango.	» Conecte correctamente el equipo. » Consulte el párrafo "Conexiones".
» Falta una fase.	» Conecte correctamente el equipo. » Consulte el párrafo "Conexiones".
» Electrónica averiada.	» Contacte con el centro de asistencia más cercano para la reparación del sistema.

Alimentación del alambre bloqueada

Causa	Solución
» Botón de la antorcha averiado.	» Sustituya el componente averiado. » Contacte con el centro de asistencia más cercano para la reparación del sistema.
» Rodillos inadecuados o gastados.	» Sustituya los rodillos.
» Alimentador del alambre averiado.	» Sustituya el componente averiado. » Contacte con el centro de asistencia más cercano para la reparación del sistema.
» Recubrimiento de la antorcha dañado.	» Sustituya el componente averiado. » Contacte con el centro de asistencia más cercano para la reparación del sistema.
» El alimentador del alambre no recibe corriente.	» Compruebe la conexión a la fuente de alimentación. » Consulte el párrafo "Conexiones". » Contacte con el centro de asistencia más cercano para la reparación del sistema.
» Alambre enredado en la bobina.	» Desenrede el alambre o sustituya la bobina.
» Boquilla de la antorcha fundida (hilo pegado).	» Sustituya el componente averiado.

Alimentación de alambre irregular

Causa	Solución
» Botón de la antorcha averiado.	» Sustituya el componente averiado. » Contacte con el centro de asistencia más cercano para la reparación del sistema.
» Rodillos inadecuados o gastados.	» Sustituya los rodillos.
» Alimentador del alambre averiado.	» Sustituya el componente averiado. » Contacte con el centro de asistencia más cercano para la reparación del sistema.
» Recubrimiento de la antorcha dañado.	» Sustituya el componente averiado. » Contacte con el centro de asistencia más cercano para la reparación del sistema.
» Embrague enrollador o dispositivos de bloqueo de los rodillos mal regulados.	» Afloje el embrague. » Aumente la presión en los rodillos.

Inestabilidad del arco

Causa	Solución
» Protección de gas insuficiente.	» Ajuste el flujo de gas. » Compruebe que el difusor y la boquilla de gas de la antorcha estén en buenas condiciones.

- | | |
|--|--|
| » Presencia de humedad en el gas de soldadura. | » Utilice siempre productos y materiales de calidad. |
| » Parámetros de soldadura incorrectos. | » Mantenga en perfectas condiciones el sistema de suministro del gas. |
| » Parámetros de soldadura incorrectos. | » Compruebe cuidadosamente el sistema de soldadura. |
| » Protección de gas insuficiente. | » Contacte con el centro de asistencia más cercano para la reparación del sistema. |

Proyecciones excesivas de salpicaduras

- | Causa | Solución |
|--|---|
| » Longitud de arco incorrecta. | » Reduzca la distancia entre electrodo y pieza. |
| » Parámetros de soldadura incorrectos. | » Reduzca la tensión de soldadura. |
| » Protección de gas insuficiente. | » Reduzca la tensión de soldadura. |
| » Dinámica de arco incorrecta. | » Ajuste el flujo de gas. |
| » Modo de soldadura incorrecto. | » Compruebe que el difusor y la boquilla de gas de la antorcha estén en buenas condiciones. |
| » Dinámica de arco incorrecta. | » Aumente el valor inductivo del circuito. |
| » Modo de soldadura incorrecto. | » Utilice una toma inductiva mayor. |
| » Modo de soldadura incorrecto. | » Reduzca la inclinación de la antorcha. |

Insuficiente penetración

- | Causa | Solución |
|--|--|
| » Modo de soldadura incorrecto. | » Reduzca la velocidad de avance durante la soldadura. |
| » Parámetros de soldadura incorrectos. | » Aumente la corriente de soldadura. |
| » Electrodo inadecuado. | » Utilice un electrodo de diámetro más pequeño. |
| » Preparación incorrecta de los bordes. | » Aumente la apertura del achaflanado. |
| » Conexión de masa incorrecta. | » Conecte correctamente la masa. |
| » Las piezas a soldar son demasiado grandes. | » Consulte el párrafo "Instalación". |
| » Las piezas a soldar son demasiado grandes. | » Aumente la corriente de soldadura. |

Inclusiones de escoria

- | Causa | Solución |
|---|--|
| » Limpieza incompleta. | » Limpie perfectamente las piezas antes de la soldadura. |
| » Electrodo de diámetro muy grueso. | » Utilice un electrodo de diámetro más pequeño. |
| » Preparación incorrecta de los bordes. | » Aumente la apertura del achaflanado. |
| » Modo de soldadura incorrecto. | » Reduzca la distancia entre electrodo y pieza. |
| » Modo de soldadura incorrecto. | » Avance regularmente durante la soldadura. |

Inclusiones de tungsteno

- | Causa | Solución |
|--|---|
| » Parámetros de soldadura incorrectos. | » Reduzca la tensión de soldadura. |
| » Electrodo inadecuado. | » Utilice un electrodo de diámetro superior. |
| » Modo de soldadura incorrecto. | » Utilice siempre productos y materiales de calidad. |
| » Modo de soldadura incorrecto. | » Afile correctamente el electrodo. |
| » Modo de soldadura incorrecto. | » Evite los contactos entre electrodo y soldadura de inserción. |

Sopladuras

- | Causa | Solución |
|-----------------------------------|---|
| » Protección de gas insuficiente. | » Ajuste el flujo de gas. |
| » Protección de gas insuficiente. | » Compruebe que el difusor y la boquilla de gas de la antorcha estén en buenas condiciones. |

Encoladura

- | Causa | Solución |
|--------------------------------|---|
| » Longitud de arco incorrecta. | » Aumente la distancia entre electrodo y pieza. |
| » Longitud de arco incorrecta. | » Aumente la tensión de soldadura. |

» Parámetros de soldadura incorrectos.

» Aumente la corriente de soldadura.

» Aumente la tensión de soldadura.

» Modo de soldadura incorrecto.

» Aumente el ángulo de inclinación de la antorcha.

» Las piezas a soldar son demasiado grandes.

» Aumente la corriente de soldadura.

» Dinámica de arco incorrecta.

» Aumente el valor inductivo del circuito.

» Utilice una toma inductiva mayor.

Incisiones marginales

Causa

» Parámetros de soldadura incorrectos.

Solución

» Reduzca la tensión de soldadura.
» Utilice un electrodo de diámetro más pequeño.

» Longitud de arco incorrecta.

» Reduzca la distancia entre electrodo y pieza.
» Reduzca la tensión de soldadura.

» Modo de soldadura incorrecto.

» Reduzca la velocidad de oscilación lateral en el llenado.
» Reduzca la velocidad de avance durante la soldadura.

» Protección de gas insuficiente.

» Utilice gases adecuados para los materiales a soldar.

Oxidaciones

Causa

» Protección de gas insuficiente.

Solución

» Ajuste el flujo de gas.
» Compruebe que el difusor y la boquilla de gas de la antorcha estén en buenas condiciones.

Porosidades

Causa

» Presencia de grasa, pintura, óxido o suciedad en las piezas a soldar.

Solución

» Limpie perfectamente las piezas antes de la soldadura.

» Presencia de grasa, pintura, óxido o suciedad en el material de aportación.

» Utilice siempre productos y materiales de calidad.
» Mantenga siempre en perfectas condiciones el material de aportación.

» Presencia de humedad en el material de aportación.

» Utilice siempre productos y materiales de calidad.
» Mantenga siempre en perfectas condiciones el material de aportación.

» Longitud de arco incorrecta.

» Reduzca la distancia entre electrodo y pieza.
» Reduzca la tensión de soldadura.

» Presencia de humedad en el gas de soldadura.

» Utilice siempre productos y materiales de calidad.
» Mantenga en perfectas condiciones el sistema de suministro del gas.

» Protección de gas insuficiente.

» Ajuste el flujo de gas.
» Compruebe que el difusor y la boquilla de gas de la antorcha estén en buenas condiciones.

» Solidificación muy rápida de la soldadura de inserción.

» Reduzca la velocidad de avance durante la soldadura.
» Precaliente las piezas a soldar.
» Aumente la corriente de soldadura.

Grietas en caliente

Causa

» Parámetros de soldadura incorrectos.

Solución

» Reduzca la tensión de soldadura.
» Utilice un electrodo de diámetro más pequeño.

» Presencia de grasa, pintura, óxido o suciedad en las piezas a soldar.

» Limpie perfectamente las piezas antes de la soldadura.

» Presencia de grasa, pintura, óxido o suciedad en el material de aportación.

» Utilice siempre productos y materiales de calidad.
» Mantenga siempre en perfectas condiciones el material de aportación.

» Modo de soldadura incorrecto.

» Siga las secuencias operativas correctas para el tipo de unión a soldar.

» Piezas a soldar con características diferentes.

» Aplique un depósito superficial preliminar antes de la soldadura.

Grietas en frío

Causa

- » Presencia de humedad en el material de aportación.
- » Forma especial de la unión a soldar.

Solución

- » Utilice siempre productos y materiales de calidad.
- » Mantenga siempre en perfectas condiciones el material de aportación.
- » Precaliente las piezas a soldar.
- » Haga un postcalentamiento.
- » Siga las secuencias operativas correctas para el tipo de unión a soldar.

9. NOCIONES TEÓRICAS SOBRE LA SOLDADURA

9.1 Soldaduras con electrodo recubierto (MMA)

Preparación de los bordes

Para obtener buenas soldaduras es recomendable trabajar sobre piezas limpias, no oxidadas, sin herrumbre ni otros agentes contaminadores.

Elección del electrodo

El diámetro del electrodo que se ha de emplear depende del espesor del material, de la posición, del tipo de unión y del tipo de preparación de la pieza a soldar. Los electrodos de mayor diámetro requieren corrientes muy elevadas y en consecuencia una mayor aportación térmica en la soldadura.

Tipo de revestimiento	Propiedades	Uso
Rútilo	Facilidad de uso	Todas las posiciones
Ácido	Alta velocidad de fusión	Plano
Básico	Alta calidad de la unión	Todas las posiciones

Elección de la corriente de soldadura

La gama de la corriente de soldadura relativa al tipo de electrodo utilizado está especificada por el fabricante en el mismo embalaje de los electrodos.

Encendido y mantenimiento del arco

El arco eléctrico se produce al frotar la punta del electrodo sobre la pieza a soldar conectada al cable de masa y, una vez encendido el arco, retirando rápidamente el electrodo hasta situarlo en la distancia de soldadura normal.

Para mejorar el encendido del arco es útil, en general, un incremento inicial de corriente respecto a la corriente base de soldadura (Hot Start). Una vez que se ha producido el arco eléctrico, empieza la fusión de la parte central del electrodo que se deposita en forma de gotas en la pieza a soldar. El revestimiento externo del electrodo se consume, suministrando así el gas de protección para la soldadura y garantizando su buena calidad. Para evitar que las gotas de material fundido, apaguen el arco al provocar un cortocircuito y pegarse el electrodo al baño de soldadura, debido a su proximidad, se produce un aumento provisional de la corriente de soldadura para fundir el cortocircuito (Arc Force). Si el electrodo quedara pegado a la pieza por a soldar es útil reducir al mínimo la corriente de cortocircuito (antisticking).

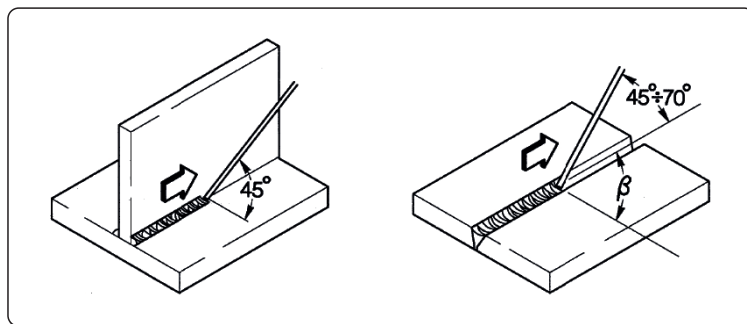

Ejecución de la soldadura

El ángulo de inclinación del electrodo cambia según el número de pasadas; el movimiento del electrodo se realiza normalmente con oscilaciones y paradas a los lados del cordón para evitar la excesiva acumulación del material de aportación en la parte central.

Retirar la escoria

La soldadura mediante electrodos recubiertos obliga a retirar la escoria tras cada pasada. La limpieza se efectúa mediante un pequeño martillo o mediante cepillo en caso de escoria fría.

ES

9.2 Soldadura TIG (arco continuo)

Descripción

El proceso de soldadura TIG (Tungsten Inert Gas) se basa en la presencia de un arco eléctrico que se forma entre un electrodo infusible (de tungsteno puro o en aleación, con una temperatura de fusión de aproximadamente 3370°C) y la pieza; una atmósfera de gas inerte (argón) asegura la protección del baño. Para evitar inserciones peligrosas de tungsteno en la unión, el electrodo jamás tiene que entrar en contacto con la pieza a soldar; por ello, la fuente de alimentación de soldadura dispone normalmente de un dispositivo de encendido del arco que genera una descarga de alta frecuencia y alta tensión entre la punta del electrodo y la pieza a soldar. Así, gracias a la chispa eléctrica, al ionizarse la atmósfera del gas se enciende el arco de soldadura sin que haya contacto entre el electrodo y la pieza a soldar. Existe también otro tipo de inicio, con menos inclusiones de tungsteno: el inicio en lift que no necesita alta frecuencia, sino sólo de una situación inicial de un cortocircuito de baja corriente entre el electrodo y la pieza; en el momento en que se levanta el electrodo se establece el arco, y la corriente aumenta hasta el valor de soldadura introducido. Para mejorar la calidad de la parte final del cordón de soldadura es útil poder controlar con exactitud el descenso de la corriente de soldadura y es necesario que el gas fluya en el baño de soldadura durante unos segundos después de la extinción del arco. En muchas condiciones de trabajo es útil poder disponer de 2 corrientes de soldadura programadas previamente y poder pasar fácilmente de una a otra (Bilevel).

Polaridad de soldadura

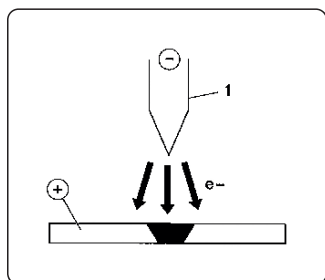

D.C.S.P. (Direct Current Straight Polarity)

Es la polaridad más utilizada (polaridad directa), permite un reducido desgaste del electrodo (1) puesto que el 70% del calor se concentra sobre el ánodo (es decir, sobre la pieza).

Se obtienen baños estrechos y hondos con elevada velocidad de avance y, en consecuencia, con baja aportación térmica.

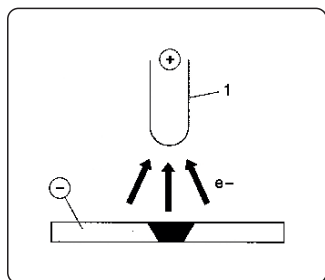

D.C.R.P. (Direct Current Reverse Polarity)

La polaridad invertida permite la soldadura de aleaciones recubiertas por una capa de óxido refractario con temperatura de fusión superior a la del metal.

No se pueden utilizar corrientes elevadas, puesto que éstas producirían un elevado desgaste del electrodo.

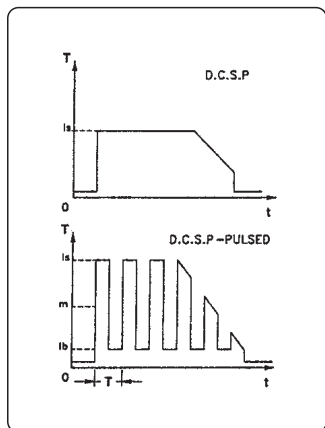

D.C.S.P.-Pulsed (Direct Current Straight Polarity Pulsed)

La utilización de una corriente directa intermitente permite un mejor control del baño de soldadura en determinadas condiciones de trabajo.

El baño de soldadura se forma por los impulsos de punta (Ip), mientras que la corriente de base (Ib) mantiene el arco encendido. Esta solución facilita la soldadura de pequeños espesores con menores deformaciones, un mejor factor de forma y consiguiente menor peligro de agrietamiento en caliente y de inclusiones gaseosas.

Al aumentar la frecuencia (media frecuencia) se obtiene un arco más estrecho, más concentrado y más estable y una ulterior mejora de la calidad de la soldadura de espesores delgados.

Soldaduras TIG de los aceros

El procedimiento TIG es muy eficaz en la soldadura de aceros, tanto al carbono como aleaciones, para la primera pasada sobre tubos y en las soldaduras que deben presentar un aspecto estético excelente. Se requiere la polaridad directa (D.C.S.P.).

Preparación de los bordes

El procedimiento requiere una cuidadosa limpieza y preparación de los bordes.

Elección y preparación del electrodo

Se aconseja usar electrodos de tungsteno de torio (2% de torio-color rojo) o, como alternativa, electrodos de cerio o de lantano con los siguientes diámetros:

Ø electrodo	Gama de corriente
1.0 mm	15÷75 A
1.6 mm	60÷150 A
2.4 mm	130÷240 A

El electrodo debe estar afilado de la forma mostrada en la figura.

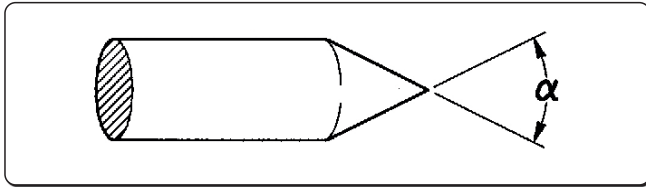

α°	Gama de corriente
30	0÷30 A
60÷90	30÷120 A
90÷120	120÷250 A

Material de aportación

Las varillas de aportación deben tener unas propiedades mecánicas similares a las del material de base.

No utilice trozos extraídos del material de base, puesto que pueden afectar negativamente a las soldaduras mismas.

Gas de protección

Prácticamente se utiliza siempre el argón puro (99.99%).

Corriente de soldadura	Ø electrodo	Boquilla gas nº	Boquilla gas	Flujo de argón
30 A	0÷30 mm	4/5	6/8.0 mm	5-6 l/min
60÷90 A	30÷120 mm	4/5/6	6.5/8.0/9.5 mm	6-7 l/min
90÷120 A	120÷250 mm	6/7	9.5/11.0 mm	7-8 l/min

Soldadura TIG de cobre

Puesto que es un procedimiento de elevada concentración térmica, el TIG es especialmente indicado en la soldadura de materiales con elevada conductividad térmica, como es el cobre.

Para la soldadura TIG del cobre siga las mismas indicaciones que para la soldadura TIG de los aceros o textos específicos.

9.3 Soldadura con alambre continuo (MIG/MAG)

Introducción

Un sistema MIG está formado por una fuente de alimentación de corriente continua, un alimentador y una bobina de alambre, una antorcha y gas.

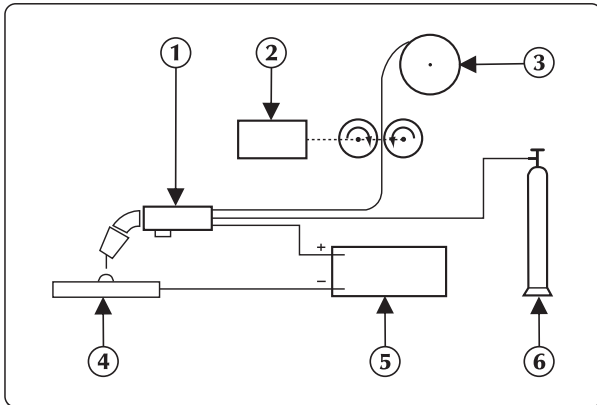

Sistema de soldadura manual MIG

La corriente llega al arco por el electrodo fusible (alambre con polaridad positiva);

En este procedimiento el metal fundido se transmite a la pieza por soldar mediante el arco.

El avance automático del electrodo del material de aportación continuo (alambre) es necesario para reintegrar el alambre fundido durante la soldadura.

Métodos

MIG, disponemos de dos mecanismos principales de transferencia del metal, que pueden clasificarse según los medios de transmisión del metal desde el electrodo hasta la pieza a soldar.

El primer método definido como "TRANSFERENCIA EN CORTO CIRCUITO (SHORT-ARC)", crea un pequeño baño de soldadura de solidificación rápida en que el metal se transfiere desde el electrodo hasta la pieza a soldar durante un corto periodo en que el electrodo entra en contacto con el baño. En este intervalo, el electrodo entra en contacto directo con el baño de soldadura, generando un cortocircuito que funde el alambre, y que por lo tanto se interrumpe. Entonces el arco vuelve a encenderse y el ciclo se repite.

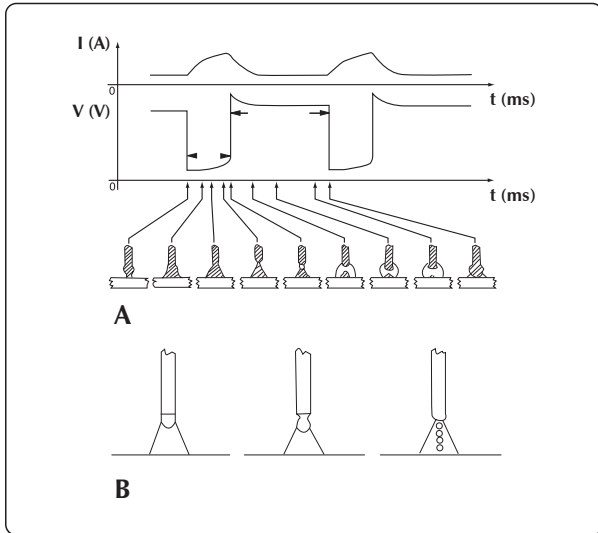

Ciclo SHORT y soldadura SPRAY ARC

Otro método para conseguir la transferencia del metal es la "TRANSFERENCIA CON ROCIADO (SPRAY-ARC)", donde la transferencia del metal se produce en forma de gotas muy pequeñas que se forman y se desprenden de la punta del alambre, y se transfieren al baño de soldadura mediante el flujo del arco.

Parámetros de soldadura

La visibilidad del arco reduce la necesidad de una rígida observar estrictamente las tablas de ajuste por parte del operador que tiene la posibilidad de controlar directamente el baño de soldadura.

- La tensión influencia directamente el aspecto del cordón, pero las dimensiones de la superficie soldada se pueden variar según las exigencias, actuando manualmente sobre el moviendo manualmente la antorcha en modo para obtener depósitos variables con tensión constante.
- La velocidad de avance del alambre es proporcional a la corriente de soldadura.

En las dos figuras siguientes se muestran las relaciones entre los diferentes parámetros de soldadura.







Tabla guía aproximada para la elección de los parámetros de soldadura referida a las aplicaciones más típicas y a los alambre más utilizados

Tensión de arco	Ø 0,8 mm	Ø 1,0-1,2 mm	Ø 1,6 mm	Ø 2,4 mm
16V - 22V SHORT - ARC				
	60 - 160 A Baja penetración para pequeños espesores	100 - 175 A Buen control de la penetración y la fusión	120 - 180 A Buena fusión en plano y en vertical	150 - 200 A No utilizado
24V - 28V SEMI SHORT-ARC (Zona de transición)				
	150 - 250 A Soldadura automática de ángulo	200 - 300 A Soldadura automática a tensión alta	250 - 350 A Soldadura automática descendiente	300 - 400 A No utilizado
30V - 45V SPRAY - ARC				
	150 - 250 A Baja penetración con ajuste a 200 A	200 - 350 A Soldadura automática con pasadas múltiples	300 - 500 A Buena penetración descendiente	500 - 750 A Buena penetración, alto depósito en grandes espesores

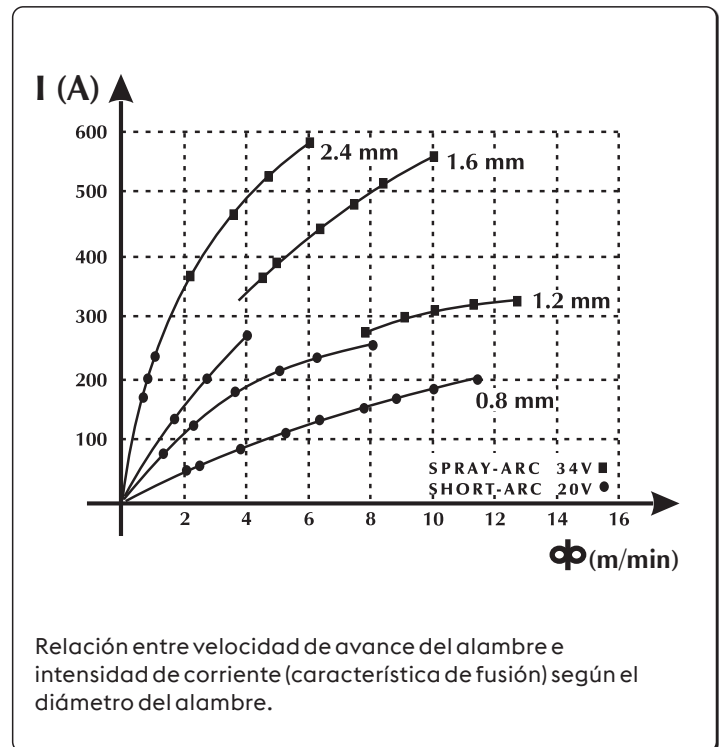
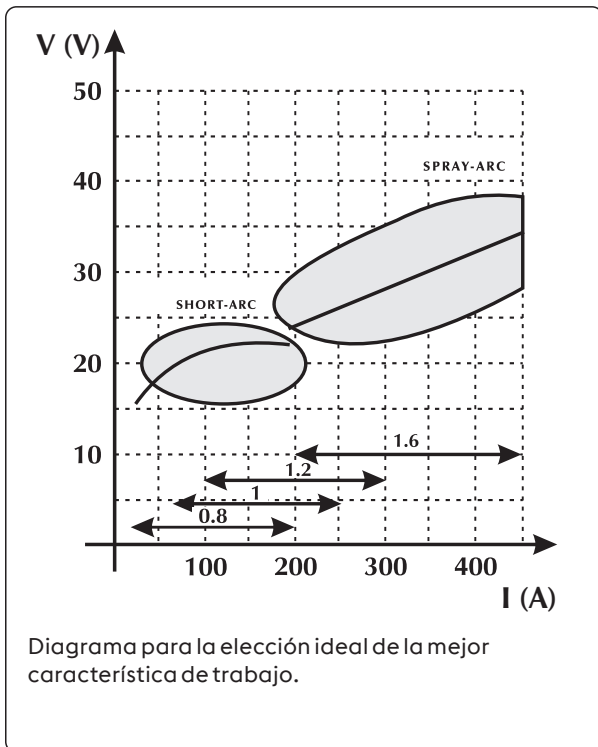
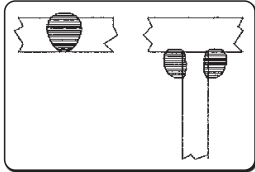
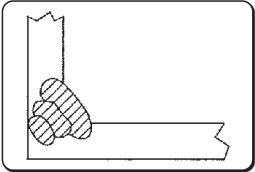
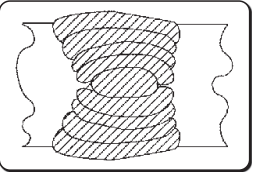
Gases utilizables

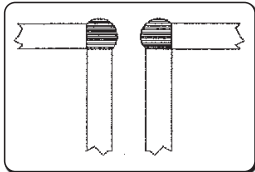
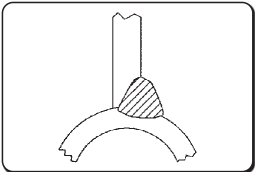
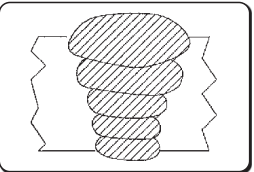
La soldadura MIG-MAG se caracteriza principalmente por el tipo de gas utilizado, inerte para la soldadura MIG (Metal Inert Gas), activo para la soldadura MAG (Metal Active Gas).

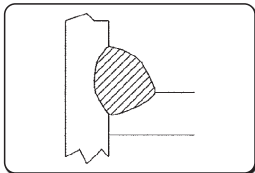
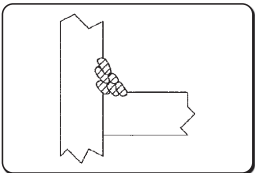
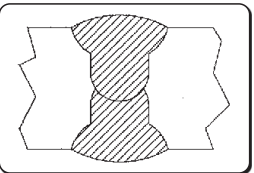
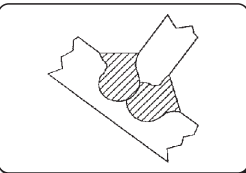
- Anhídrido carbónico (CO₂)

Si utiliza CO₂ como gas de protección se conseguirá elevadas penetraciones con elevada velocidad de avance y buenas propiedades mecánicas con un bajo coste de ejercicio. A pesar de esto, el empleo de este gas crea notables problemas sobre la composición química final de las uniones, se produce una pérdida de elementos fácilmente oxidables y se obtiene al mismo tiempo un enriquecimiento de carbono en el baño. La soldadura con CO₂ puro también da otros tipos de problemas como la excesiva presencia de salpicaduras y la formación de porosidades de monóxido de carbono.

- Argón

Este gas inerte se utiliza puro en la soldadura de las aleaciones ligeras, mientras para la soldadura de aceros inoxidable al cromo-níquel es preferible trabajar añadiendo oxígeno y CO₂ en un porcentaje del 2%, ya que esto contribuye a la estabilidad del arco y a la mejor forma del cordón.

- Helio

Este gas se utiliza como alternativa al argón y permite mayores penetraciones (en grandes espesores) y mayores velocidades de avance.

- Mezcla Argón-Helio

Se consigue un arco más estable respecto al helio puro, además de una mayor penetración y velocidad respecto al argón.

- Mezcla Argón- CO₂ y Argón-CO₂-oxígeno

Estas mezclas se utilizan sobre todo en la soldadura de los materiales ferrosos en condiciones de el modo de funcionamiento SHORT-ARC ya que mejora el aporte térmico específico. También pueden utilizarse en SPRAY-ARC.

Normalmente la mezcla contiene un porcentaje de CO₂ que va de las del 8% al 20% y de O₂ alrededor del 5%. Consulte el manual del usuario del dispositivo.

10. CARACTERÍSTICAS TÉCNICAS

Características eléctricas			U.M.
Tensión de alimentación U1 (50/60 Hz)	3x230 (±15%)	3x400 (±15%)	Vac
Zmax (@PCC)*	62	62	mΩ
Fusible de línea retardado	30	20	A
Tipo de comunicación	DIGITAL	DIGITAL	
Potencia máxima absorbida	13.3	13.0	kVA
Potencia máxima absorbida	12.8	12.4	kW
Potencia absorbida en estado inactivo	71	71	W
Factor de potencia (PF)	0.96	0.95	
Rendimiento (μ)	85	85	%
Cos φ	0.99	0.99	
Corriente máxima absorbida I1max	32.9	18.8	A
Corriente efectiva I1eff	20.8	13.3	A
Gama de ajuste (MMA)	3-320	3-320	A
Tensión en vacío Uo	75	75	Vdc

*Este dispositivo cumple con los requisitos de la Normativa EN / IEC 61000-3-11.

*Este dispositivo cumple con los requisitos de la normativa EN / IEC 61000-3-12, si la máxima impedancia de red admitida en el punto de interacción con la red pública (punto de acoplamiento común - "point of common coupling", PCC) es inferior o igual al valor "Zmax" declarado. Si el dispositivo se conecta a la red pública de baja tensión, es responsabilidad del instalador o del usuario, consultando eventualmente al gestor de la red si es necesario, asegurarse de que el dispositivo se puede conectar.

Ciclo de trabajo	3x230V	3x400V	U.M.
Ciclo de trabajo MMA (40°C)			
(X=35%)	320	-	A
(X=50%)	-	320	A
(X=60%)	270	300	A
(X=100%)	230	250	A
Ciclo de trabajo MMA (25°C)			
(X=60%)	320	320	A
(X=100%)	270	270	A
Ciclo de trabajo TIG (40°C)			
(X=45%)	320	-	A
(X=60%)	300	320	A
(X=100%)	250	270	A
Ciclo de trabajo TIG (25°C)			
(X=70%)	320	320	A
(X=100%)	270	270	A
Ciclo de trabajo MIG/MAG (40°C)			
(X=35%)	320	-	A
(X=50%)	-	320	A
(X=60%)	280	310	A
(X=100%)	230	250	A
Ciclo de trabajo MIG/MAG (25°C)			
(X=60%)	320	-	A
(X=70%)	-	320	A
(X=100%)	270	270	A

Características físicas			U.M.
Grado de protección IP	IP23S		
Clase de aislamiento	H		
Dimensiones (lxwxh)	620x240x460		mm
Peso	26.7		Kg
Normas de fabricación	EN IEC 60974-1/A1:2019 EN IEC 60974-3:2019 EN 60974-10/A1:2015		
Sección cable de alimentación	4x4		mm ²
Longitud de cable de alimentación	5		m

11. PLACA DE CARACTERÍSTICAS

VOESTALPINE BÖHLER WELDING SELCO S.R.L. Via Palladio, 19 - ONARA (PADOVA) - ITALY					
URANOS NX 3200 PME		N°			
		X (40°C)	50% (35%)	60%	100%
		I ₂	320A (320A)	300A (270A)	250A (230A)
		U ₂	32.8V (32.8V)	32.0V (30.8V)	30.0V (29.2V)
		X (40°C)	(45%)	60%	100%
		I ₂	(320A)	320A (300A)	270A (250A)
		U ₂	(22.8V)	22.8V (22.0V)	20.8V (20.0V)
		X (40°C)	50% (35%)	60%	100%
		I ₂	320A (320A)	310A (280A)	250A (230A)
		U ₂	30.0V (30.0V)	29.5V (28.5V)	26.5V (25.5V)
	U ₁ 400V(230V)	I _{1max} 18.8A(32.9A)	I _{1eff} 13.3A(20.8A)		
IP 23 S					

ES

12. SIGNIFICADO DE LA ETIQUETA DE LOS DATOS

1		2			
3		4			
5		6			
7	9	23			
		11			
8	10	12	15	16	17
		13	15A	16A	17A
		14	15B	16B	17B
7	9	11			
		11			
8	10	12	15	16	17
		13	15A	16A	17A
		14	15B	16B	17B
18	19	20	21		
22					

- 1 Marca de fabricación
- 2 Nombre y dirección del fabricante
- 3 Modelo del aparato
- 4 N° de serie
- X **XX**XXXXXXXXXX Año de fabricación
- 5 Símbolo del tipo de la unidad de soldadura
- 6 Referencia a las normas de construcción
- 7 Símbolo del proceso de soldadura
- 8 Símbolo por las soldadoras para los equipos adecuados para trabajar en un entorno con riesgo elevado de descarga eléctrica
- 9 Símbolo de la corriente de soldadura
- 10 Tensión asignada a vacío
- 11 Gama de la corriente máxima y mínima, y de la correspondiente tensión convencional de carga
- 12 Símbolo del ciclo de intermitencia
- 13 Símbolo de la corriente asignada de soldadura
- 14 Símbolo de la tensión asignada de soldadura
- 15 Valores del ciclo de intermitencia
- 16 Valores del ciclo de intermitencia
- 17 Valores del ciclo de intermitencia
- 15A Valores de la corriente asignada de soldadura
- 16A Valores de la corriente asignada de soldadura
- 17A Valores de la corriente asignada de soldadura
- 15B Valores de la tensión convencional de carga
- 16B Valores de la tensión convencional de carga
- 17B Valores de la tensión convencional de carga
- 18 Símbolo de la alimentación
- 19 Tensión asignada de alimentación
- 20 Máxima corriente asignada de alimentación
- 21 Máxima corriente efectiva de alimentación
- 22 Grado de protección
- 23 Tensión nominal de pico

- CE Declaración UE de conformidad
- EAC Declaración de conformidad EAC
- UKCA Declaración de conformidad UKCA

DECLARAÇÃO DE CONFORMIDADE CE

O construtor

voestalpine Böhler Welding Selco S.r.l. - Via Palladio, 19 - 35019 Onara di Tombolo (PD) - ITALY
Tel. +39 049 9413/111 - Fax +39 049 9413/311 - www.voestalpine.com/welding

declara sob sua exclusiva responsabilidade que o seguinte produto:

URANOS NX 3200 PME	55.03.066
	55.03.070

está conforme as directivas UE:

2014/35/EU LOW VOLTAGE DIRECTIVE
2014/30/EU EMC DIRECTIVE
2011/65/EU RoHS DIRECTIVE

e que as seguintes normas harmonizadas foram aplicadas:

EN IEC 60974-1/A1:2019	WELDING POWER SOURCE
EN 60974-10/A1:2015	ELECTROMAGNETIC COMPATIBILITY REQUIREMENTS

A documentação que atesta o cumprimento das diretrizes ficará à disposição para vistorias no referido fabricante.

Qualquer operação ou modificação não autorizada, previamente, pela voestalpine Böhler Welding Selco S.r.l. anulará a validade desta declaração.

Onara di Tombolo, 15/10/2021

voestalpine Böhler Welding Selco s.r.l.

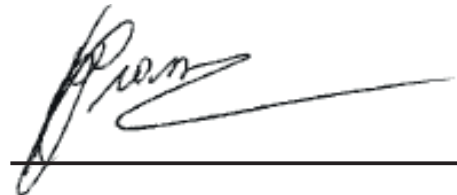

Lino Frasson

ÍNDICE GERAL

1. ATENÇÃO	237
1.1 Condições de utilização.....	237
1.2 Protecção do operador e de outros indivíduos	237
1.3 Protecção contra fumos e gases	238
1.4 Prevenção contra incêndios/explosões	238
1.5 Precauções na utilização das botijas de gás	239
1.6 Protecção contra choques eléctricos.....	239
1.7 Campos electromagnéticos e interferências	239
1.8 Grau de protecção IP	240
1.9 Descarte.....	240
2. INSTALAÇÃO.....	241
2.1 Elevação, transporte e descarga	241
2.2 Posicionamento do equipamento.....	241
2.3 Ligações.....	241
2.4 Instalação.....	242
3. APRESENTAÇÃO DO SISTEMA	244
3.1 Painel traseiro.....	244
3.2 Painel de tomadas.....	244
3.3 Painel de comandos frontal.....	244
3.4 Painel de comandos frontal.....	245
4. UTILIZAÇÃO DO EQUIPAMENTO	246
4.1 Ecrã inicial.....	246
4.2 Ecrã de teste	246
4.3 Ecrã principal.....	247
4.4 Az MMA folyamat főképernyője.....	247
5. DEFINIÇÕES.....	254
5.1 Definições e definição dos parâmetros	254
5.2 Procedimentos específicos de utilização dos parâmetros	263
6. MANUTENÇÃO.....	268
6.1 Efectuar periodicamente as seguintes operações.....	268
6.2 Ansvár.....	268
7. CÓDIGOS DE ALARME.....	268
8. RESOLUÇÃO DE PROBLEMAS.....	270
9. NOÇÕES TEÓRICAS SOBRE A SOLDADURA.....	274
9.1 Soldadura manual por arco voltaico (MMA)	274
9.2 Soldadura TIG (arco contínuo).....	275
9.3 Soldadura com fio contínuo (MIG/MAG)	276
10. CARACTERÍSTICAS TÉCNICAS.....	279
11. PLACA DE DADOS.....	280
12. SIGNIFICADO DA PLACA DE DADOS	280
13. DIAGRAMA.....	557
14. CONECTORES.....	559
15. LISTA DE PEÇAS DE REPOSIÇÃO	560

SIMBOLOS



Perigo iminente de lesões corporais graves e de comportamentos perigosos que podem provocar lesões corporais graves.



Informação importante a seguir de modo a evitar lesões menos graves ou danos em bens.



Todas as notas precedidas deste símbolo são sobretudo de carácter técnico e facilitam as operações.

1. ATENÇÃO



Antes de iniciar qualquer tipo de operação na máquina, é necessário ler cuidadosamente e compreender o conteúdo deste manual.

Não efectuar modificações ou operações de manutenção que não estejam previstas. O fabricante não se responsabiliza por danos causados em pessoas ou bens, resultantes da utilização incorrecta ou da não-aplicação do conteúdo deste manual.

Säilytä käyttöohjeet aina laitteen käyttöpaikassa. Noudata käyttöohjeiden lisäksi voimassa olevia paikallisia tapaturmantorjuntaa ja ympäristön suojelua koskevia yleisiä määräyksiä ja sääntöjä.



Kaikkien laitteen käyttöönottoon, käyttöön, huoltoon ja korjaukseen osallistuvien henkilöiden tulee:

- omata asianmukainen pätevyys
- omata hitsauksessa tarvittavat taidot
- lukea nämä käyttöohjeet kokonaan ja noudattaa niitä tarkasti

Para quaisquer dúvidas ou problemas relativos à utilização do equipamento, ainda que não se encontrem aqui descritos, consultar pessoal qualificado.

1.1 Condições de utilização



Cada instalação deve ser utilizada exclusivamente para as operações para que foi projectada, nos modos e nos âmbitos previstos na chapa de características e/ou neste manual, de acordo com as directivas nacionais e internacionais relativas à segurança. Uma utilização diferente da expressamente declarada pelo construtor deve ser considerada completamente inadequada e perigosa e, neste caso, o construtor declina toda e qualquer responsabilidade.



Esta máquina só deve ser utilizada com fins profissionais, numa instalação industrial. O construtor declina qualquer responsabilidade por eventuais danos provocados pela utilização da instalação em ambientes domésticos.



O equipamento deve ser utilizado em ambientes cujas temperaturas estejam compreendidas entre -10°C e +40°C (entre +14°F e +104°F).

O equipamento deve ser transportado e armazenado em ambientes cujas temperaturas estejam compreendidas entre -25°C e +55°C (entre -13°F e 131°F).

O equipamento deve ser utilizado em ambientes sem poeira, ácidos, gases ou outras substâncias corrosivas.

O equipamento deve ser utilizado em ambientes com humidade relativa não superior a 50%, a 40°C (104°F).

O equipamento deve ser utilizado em ambientes com humidade relativa não superior a 90%, a 20°C (68°F).

O equipamento deve ser utilizado a uma altitude máxima, acima do nível do mar, não superior a 2000 m (6500 pés).



Não utilizar o aparelho para descongelar tubos.

Não utilizar este equipamento para carregar baterias e/ou acumuladores.

Não utilizar este equipamento para fazer arrancar motores.

1.2 Protecção do operador e de outros indivíduos



O processo de soldadura é uma fonte nociva de radiações, ruído, calor e gases. Colocar um ecrã de protecção retardador de fogo, para proteger a área de soldadura de raios, faíscas e escórias incandescentes. Avisar todos os indivíduos nas proximidades que não devem olhar para o arco de soldadura ou metal incandescente e que devem utilizar protecção adequada.



Utilizar vestuário de protecção, para proteger a pele dos raios do arco, das faíscas ou do metal incandescente. O vestuário utilizado deve cobrir todo o corpo e deve:

- estar intacto e em bom H66estado
- ser à prova de fogo
- ser isolante e estar seco
- estar justo ao corpo e não ter dobras



Utilizar sempre calçado conforme às normas, resistentes e que garantam isolamento contra a água.

Utilizar sempre luvas conformes às normas, que garantam isolamento eléctrico e térmico.



Usar máscaras com protectores laterais da cara e filtros de protecção adequados para os olhos (pelo menos NR10 ou superior).



Utilizar sempre óculos de protecção, com protectores laterais, especialmente durante a remoção manual ou mecânica das escórias da soldadura.



Não utilizar lentes de contacto!

PT



Utilizar protectores auriculares se, durante o processo de soldadura, forem atingidos níveis de ruído perigosos. Se o nível de ruído exceder os limites previstos pela lei, delimitar a área de trabalho e assegurar que todos os indivíduos que se encontram nas proximidades dispõem de protectores auriculares.



Durante as operações de soldadura, manter os painéis laterais sempre fechados. Os sistemas não devem ser submetidos a qualquer tipo de modificação.



Durante as operações de soldadura, manter os painéis laterais sempre fechados. Evitar que mãos, cabelo, vestuário, ferramentas, etc. entrem em contacto com partes móveis, tais como: ventiladores, rodas dentadas, rolos e eixos, bobinas de fio. Não tocar nas engrenagens enquanto o mecanismo de avanço do fio estiver em funcionamento. Os sistemas não devem ser submetidos a qualquer tipo de modificação. A desactivação dos dispositivos de protecção nos mecanismos de avanço do fio é extremamente perigosa e isenta o construtor de toda e qualquer responsabilidade por eventuais danos materiais ou pessoais.



Manter a cabeça longe da tocha MIG/MAG durante o carregamento e avanço do fio. O fio em saída pode provocar danos graves nas mãos, cara e olhos.



Evitar tocar em peças acabadas de soldar, pois o elevado calor das mesmas pode causar queimaduras graves. Respeitar todas as precauções descritas anteriormente também no que diz respeito a operações posteriores à soldadura pois podem desprender-se escórias das peças que estão a arrefecer.



Verificar se a tocha arrefeceu antes de executar trabalhos ou operações de manutenção.



Assegurar que o grupo de refrigeração é desactivado, antes de desligar os tubos de alimentação e retorno do líquido de refrigeração. O líquido quente em saída pode provocar queimaduras graves.



Manter perto de si um estojo de primeiros socorros, pronto a utilizar. Não subestimar qualquer queimadura ou ferida.



Antes de abandonar o posto de trabalho, deixar a área de trabalho em boas condições de segurança, de maneira a evitar danos materiais e pessoais acidentais.

1.3 Protecção contra fumos e gases



Os fumos, gases e poeiras produzidos durante o processo de soldadura podem ser nocivos para a saúde. Os fumos produzidos durante o processo de soldadura podem, em determinadas circunstâncias, provocar cancro ou danos no feto de mulheres grávidas.

- Manter a cabeça afastada dos gases e fumos de soldadura.
- Providenciar uma ventilação adequada, natural ou artificial, da zona de trabalho.
- Caso a ventilação seja inadequada, utilizar máscaras e dispositivos respiratórios.
- No caso da operação de soldadura ser efectuada numa área extremamente reduzida, o operador deverá ser observado por um colega, que deve manter-se no exterior durante todo o processo.
- Não utilizar oxigénio para a ventilação.
- Verificar a eficiência da exaustão comparando regularmente as quantidades de emissões de gases nocivos com os valores admitidos pelas normas de segurança.
- A quantidade e a periculosidade dos fumos produzidos está ligada ao material base utilizado, ao material de adição e às eventuais substâncias utilizadas para a limpeza e desengorduramento das peças a soldar. Seguir com atenção as indicações do construtor, bem como as instruções constantes das fichas técnicas.
- Não efectuar operações de soldadura perto de zonas de desengorduramento ou de pintura.
- Colocar as botijas de gás em espaços abertos ou em locais com boa ventilação.

1.4 Prevenção contra incêndios/explosões



O processo de soldadura pode provocar incêndios e/ou explosões.

- Retirar da área de trabalho e das áreas vizinhas todos os materiais ou objectos inflamáveis ou combustíveis.
- Os materiais inflamáveis devem estar a pelo menos 11 metros (35 pés) da área de soldadura ou devem estar adequadamente protegidos.
- A projecção de faíscas e de partículas incandescentes pode atingir, facilmente, as zonas circundantes, mesmo através de pequenas aberturas. Prestar especial atenção às condições de segurança de objectos e pessoas.
- Não efectuar operações de soldadura sobre ou perto de contentores sob pressão.

- Não efectuar operações de soldadura em contentores fechados ou tubos. Prestar especial atenção à soldadura de tubos ou recipientes, ainda que esses tenham sido abertos, esvaziados e cuidadosamente limpos. Resíduos de gás, combustível, óleo ou semelhantes poderiam causar explosões.
- Não efectuar operações de soldadura em locais onde haja poeiras, gases ou vapores explosivos.
- Verificar, no fim da soldadura, que o circuito sob tensão não pode entrar em contacto, acidentalmente, com partes ligadas ao circuito de terra.
- Colocar nas proximidades da área de trabalho um equipamento ou dispositivo de combate a incêndios.

1.5 Precauções na utilização das botijas de gás



As botijas de gás inerte contêm gás sob pressão e podem explodir se não estiverem garantidas as condições mínimas de segurança de transporte, de manutenção e de utilização.

- As botijas devem estar fixas verticalmente a paredes ou outros apoios, com meios adequados, para evitar quedas e choques mecânicos acidentais.
- Enroscar o capuz para a protecção da válvula, durante o transporte, a colocação em funcionamento e sempre que se concluem as operações de soldadura.
- Evitar a exposição das botijas aos raios solares, a mudanças bruscas de temperatura ou a temperaturas demasiado altas. Não expor as botijas a temperaturas demasiado altas ou baixas.
- Evitar que as botijas entrem em contacto com chamas livres, arcos eléctricos, tochas ou alicates porta-eléctrodos e materiais incandescentes projectados pela soldadura.
- Manter as botijas afastadas dos circuitos de soldadura e dos circuitos de corrente em geral.
- Ao abrir a válvula da botija, manter a cabeça afastada do ponto de saída do gás.
- Ao terminar as operações de soldadura, deve fechar-se sempre a válvula da botija.
- Nunca efectuar soldaduras sobre uma botija de gás sob pressão.
- Nunca ligar uma botija de ar comprimido directamente ao redutor de pressão da máquina! A pressão poderia superar a capacidade do redutor que conseqüentemente poderia explodir!

1.6 Protecção contra choques eléctricos



Um choque de descarga eléctrica pode ser mortal.

- Evitar tocar nas zonas normalmente sob tensão, no interior ou no exterior da máquina de soldar, enquanto a própria instalação estiver alimentada (tochas, pistolas, cabos de terra, fios, rolos e bobinas estão electricamente ligados ao circuito de soldadura).
- Efectuar o isolamento eléctrico da instalação e do operador, utilizando planos e bases secos e suficientemente isolados da terra.
- Assegurar-se de que o sistema está correctamente ligado a uma tomada e a uma fonte de alimentação equipada com condutor de terra.
- Não tocar simultaneamente em duas tochas ou em dois porta-eléctrodos.
- Se sentir um choque eléctrico, interrompa de imediato as operações de soldadura.

1.7 Campos electromagnéticos e interferências



A passagem da corrente, através dos cabos internos e externos da máquina, cria um campo electromagnético nas proximidades dos cabos de soldadura e do próprio equipamento.

- Os campos electromagnéticos podem ter efeitos (até hoje desconhecidos) sobre a saúde de quem está sujeito a exposição prolongada.
- Os campos electromagnéticos podem interferir com outros equipamentos tais como “pacemakers” ou aparelhos auditivos.



Os portadores de aparelhos electrónicos vitais (“pacemakers”) devem consultar o médico antes de procederem a operações de soldadura por arco.

1.7.1 Classificação CEM em conformidade com a norma: EN 60974-10/A1:2015.



O equipamento Classe B cumpre os requisitos de compatibilidade electromagnética em ambientes industriais e residenciais, incluindo zonas residenciais em que o fornecimento de energia eléctrica é efectuado pela rede pública de baixa tensão.



O equipamento Classe A não deve ser utilizado em zonas residenciais em que o fornecimento de energia eléctrica é efectuado pela rede pública de baixa tensão. Dado que eventuais perturbações de condutividade e radiação poderão dificultar a compatibilidade electromagnética do equipamento classe A nessas zonas.

Para mais informações, consulte o capítulo: PLACA DE DADOS ou Características técnicas.

1.7.2 Instalação, utilização e estudo da área

Este equipamento foi construído em conformidade com as indicações contidas na norma harmonizada EN 60974-10/A1:2015 e está identificado como pertencente à “CLASSE A”. Esta máquina só deve ser utilizada com fins profissionais, numa instalação industrial. O construtor declina qualquer responsabilidade por eventuais danos provocados pela utilização da instalação em ambientes domésticos.



O utilizador deve ser especializado na actividade, sendo, por isso, responsável pela instalação e pela utilização do equipamento de acordo com as indicações do fabricante. Caso se detectem perturbações electromagnéticas, o operador do equipamento terá de resolver o problema, se necessário em conjunto com a assistência técnica do fabricante.



As perturbações electromagnéticas têm sempre que ser reduzidas até deixarem de constituir um problema.



Antes de instalar este equipamento, o utilizador deverá avaliar potenciais problemas electromagnéticos que poderão ocorrer nas zonas circundantes e, particularmente, os relativos às condições de saúde das pessoas expostas, por exemplo, das pessoas que possuam “pacemakers” ou aparelhos auditivos.

1.7.3 Requisitos da rede de energia eléctrica

O equipamento de alta potência pode, em virtude da corrente primária distribuída pela rede de energia eléctrica, influenciar a qualidade da potência da rede. Por conseguinte, os requisitos ou restrições de ligação referentes à impedância da energia eléctrica máxima permitida (Z_{max}) ou à capacidade mínima de fornecimento (S_{sc}) exigida no ponto de ligação à rede pública (Ponto de Acoplamento Comum à rede pública (PAC)) podem aplicar-se a alguns tipos de equipamento (consultar os dados técnicos). Neste caso, compete ao instalador ou utilizador do equipamento garantir a ligação do equipamento, consultando o fornecedor da rede de distribuição, se necessário. Em caso de interferência, poderá ser necessário tomar precauções adicionais tais como a colocação de filtros na rede de alimentação.

É também necessário considerar a possibilidade de blindar o cabo de alimentação.

Para mais informações, consulte o capítulo: Características técnicas.

1.7.4 Precauções relacionadas com os cabos

Para minimizar os efeitos dos campos electromagnéticos, respeitar as seguintes instruções:

- Enrolar juntos e fixar, quando possível, o cabo de terra e o cabo de potência.
- Evitar enrolar os cabos à volta do corpo.
- Evitar colocar-se entre o cabo de terra e o cabo de potência (manter os dois cabos do mesmo lado).
- Os cabos deverão ser mantidos tão curtos quanto possível, colocados juntos entre si e mantidos ao nível do chão.
- Colocar o equipamento a uma certa distância da zona de soldadura.
- Os cabos devem ser colocados longe de outros cabos eventualmente presentes.

1.7.5 Ligação à terra

Deve ter-se em consideração que todos os componentes metálicos da instalação de soldadura e dos que se encontram nas suas proximidades devem ser ligados à terra. A ligação à terra deverá ser feita de acordo com as normas nacionais.

1.7.6 Ligação da peça de trabalho à terra

Quando a peça de trabalho não está ligada à terra, por razões de segurança eléctrica ou devido às suas dimensões e posição, uma ligação entre a peça e a terra poderá reduzir as emissões. É necessário ter em consideração que a ligação à terra da peça de trabalho não aumenta o risco de acidente para o operador nem danifica outros equipamentos eléctricos. A ligação à terra deverá ser feita de acordo com as normas nacionais.

1.7.7 Blindagem

A blindagem selectiva de outros cabos e equipamentos presentes na zona circundante pode reduzir os problemas provocados por interferência electromagnética.

A blindagem de toda a máquina de soldar pode ser ponderada para aplicações especiais.

1.8 Grau de protecção IP



IP23S

- Invólucro protegido contra o acesso de dedos a partes perigosas e contra objectos sólidos com diâmetro superior/ igual a 12,5 mm.
- Invólucro protegido contra chuva que caia num ângulo até 60°.
- Invólucro protegido contra os efeitos danosos devidos à entrada de água, quando as partes móveis do equipamento não estão em movimento.

1.9 Descarte



Não eliminar o equipamento eléctrico juntamente com o lixo comum!

Em conformidade com a Diretiva Europeia 2012/19/UE relativa aos Resíduos de Equipamentos Elétricos e Eletrónicos e a sua aplicação de acordo com a legislação nacional, os equipamentos eléctricos que tenham atingido o fim do seu ciclo de vida devem ser recolhidos separadamente e enviados para um centro de valorização e eliminação. Cabe ao proprietário do equipamento identificar os centros de recolha autorizados, solicitando informações às autoridades locais. A aplicação da Diretiva Europeia irá permitir melhorar o ambiente e a saúde humana.

2. INSTALAÇÃO



A instalação só pode ser executada por pessoal experiente e autorizado pelo fabricante.



Para executar a instalação, assegurar-se de que o gerador está desligado da rede de alimentação.



É proibida a ligação dos geradores em série ou em paralelo.

2.1 Elevação, transporte e descarga

- O equipamento é fornecido com uma pega, para transporte à mão.
- O equipamento não dispõe de elementos específicos para elevação.
- Utilizar um empilhador, prestando a maior atenção durante a deslocação, para evitar a queda do gerador.



Nunca subestimar o peso do equipamento, (ver características técnicas).
Nunca deslocar, ou posicionar, a carga suspensa sobre pessoas ou bens.
Não deixar cair o equipamento, nem exercer pressão desnecessária sobre ele.

2.2 Posicionamento do equipamento



Observar as seguintes regras:

- Fácil acesso aos comandos e ligações do equipamento.
- Não colocar o equipamento em espaços reduzidos.
- Nunca colocar o equipamento num plano com inclinação superior a 10° em relação ao plano horizontal.
- Ligar o equipamento num lugar seco, limpo e com ventilação apropriada.
- Proteger o equipamento da chuva e do sol.

2.3 Ligações

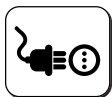

O equipamento dispõe de um cabo de alimentação para ligação à rede.

A instalação pode ser alimentada com:

- 400 V trifásico
- 230 V trifásico

O funcionamento do equipamento está garantido para tolerâncias de tensão variáveis entre $\pm 15\%$ do valor nominal; (exemplo: V_{nom} 400V a tensão de trabalho está compreendida entre os 320V e 440V).



Para evitar danos em pessoas ou no equipamento, é necessário controlar a tensão de rede seleccionada e os fusíveis ANTES de ligar a máquina à rede de alimentação. Além disso, é necessário assegurar-se de que o cabo é ligado a uma tomada que disponha de ligação à terra.



É possível alimentar a instalação por meio de um grupo electrogéneo, na condição deste garantir uma tensão de alimentação estável de $\pm 15\%$ relativamente ao valor de tensão nominal declarado pelo fabricante, em todas as condições de funcionamento possíveis e à máxima potência nominal. Normalmente, é aconselhável a utilização de grupos electrogéneos de potência nominal igual a 2 vezes a de uma fonte de alimentação monofásica ou de potência nominal igual a 1,5 vezes a de uma fonte de alimentação trifásica. É aconselhável o uso de grupos electrogéneos com controlo electrónico.



Para protecção dos utilizadores, o equipamento deve ser correctamente ligado à terra. O cabo de alimentação dispõe de um condutor (amarelo - verde) para ligação à terra, que deve ser ligado a uma ficha com ligação à terra. Este fio amarelo/verde NUNCA deve ser utilizado com outros condutores de corrente. Assegurar-se de que o local de instalação possui ligação à terra e de que as tomadas de corrente se encontram em perfeitas condições. Instalar somente fichas homologadas conformes às normas de segurança.



A instalação eléctrica deve ser executada por pessoal técnico especializado, com os requisitos técnico-profissionais específicos e em conformidade com a legislação do país em que se efectua a instalação.

2.4 Instalação

2.4.1 Ligação para a soldadura MMA



A ligação ilustrada na figura tem como resultado uma soldadura com polaridade inversa. Para obter uma soldadura com polaridade directa, inverta a ligação.

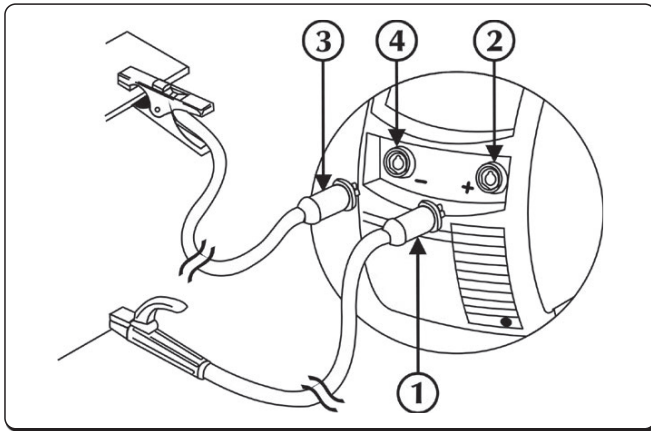

- ① Conector de pinça de ligação à terra
- ② Tomada negativa de potência (-)
- ③ Conector de pinça porta-eléctrodo
- ④ Tomada positiva de potência (+)

- ▶ Ligar o grampo de massa à tomada negativa (-) da fonte de alimentação. Inserir a ficha e rodar no sentido dos ponteiros do relógio até fixar.
- ▶ Ligar o porta-eléctrodo à tomada positiva (+) da fonte de alimentação. Inserir a ficha e rodar no sentido dos ponteiros do relógio até fixar.

2.4.2 Ligação para a soldadura TIG

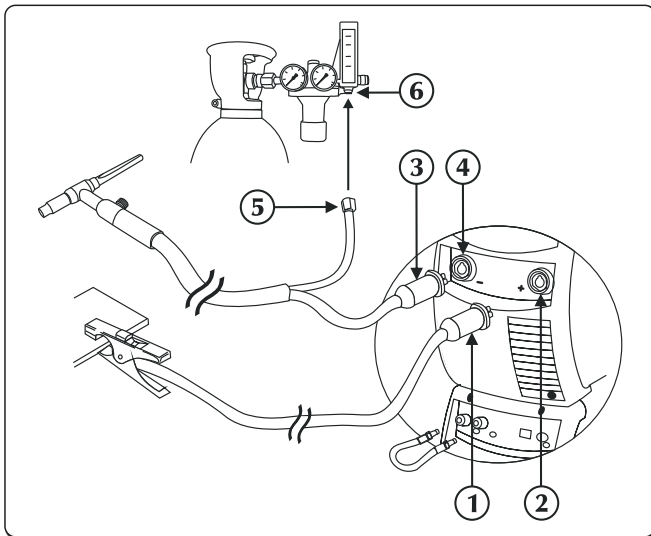

- ① Conector de pinça de ligação à terra
- ② Tomada positiva de potência (+)
- ③ Conexão da tocha TIG
- ④ Tomada da tocha
- ⑤ Conector de tubo de gás
- ⑥ Redutor de pressão

- ▶ Ligar o grampo de massa à tomada positiva (+) da fonte de alimentação. Inserir a ficha e rodar no sentido dos ponteiros do relógio até fixar.
- ▶ Ligar a tocha TIG à tomada da tocha da fonte de alimentação. Inserir a ficha e rodar no sentido dos ponteiros do relógio até fixar.



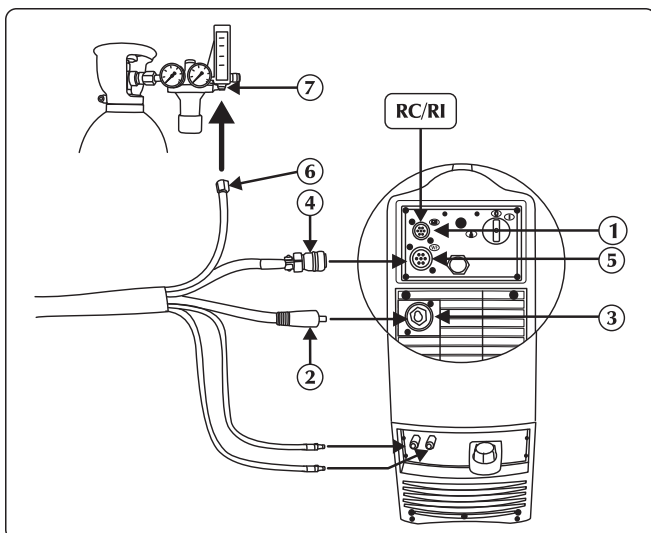

A regulação do fluxo de gás de protecção é feita através de uma rosca, normalmente localizada na própria tocha.

- ▶ Ligar separadamente o conector do tubo de gás da tocha à linha de distribuição de gás.
- ▶ Ligar o tubo de água da tocha (vermelho) ao conector rápido de entrada da unidade de refrigeração.
- ▶ Ligar o tubo de água da tocha (azul escuro) ao conector rápido de saída da unidade de refrigeração.

2.4.3 Ligação para a soldadura MIG/MAG

- ① Entrada do (CAN-BUS) cabo de sinal
- ② Cabo de alimentação
- ③ Tomada positiva de potência (+)
- ④ Cabo de sinal
- ⑤ Jelkábél bemenet (CAN-BUS) (kábelköteg)
- ⑥ Tubo de gás de tocha
- ⑦ Ligação da alimentação de gás

- ▶ Ligar o cabo de alimentação à saída específica. Inserir a ficha e rodar no sentido dos ponteiros do relógio até fixar.
- ▶ Ligar o cabo de sinal ao conector específico. Inserir o conector e rodar a porca no sentido dos ponteiros do relógio até fixar.
- ▶ Ligar o tubo de gás à válvula redutora de pressão da botija ou à ligação de alimentação do gás. Regular o fluxo do gás de 10 a 30 l/min.
- ▶ Ligar o tubo de água (azul escuro) ao conector rápido de saída (azul escuro ) da unidade de refrigeração.
- ▶ Ligar o tubo de água (vermelho) ao conector rápido de entrada (vermelho ) da unidade de refrigeração.

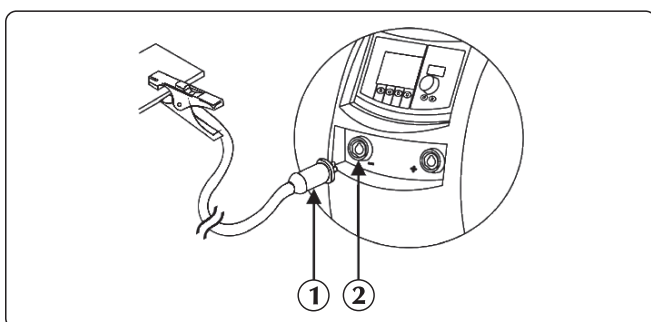

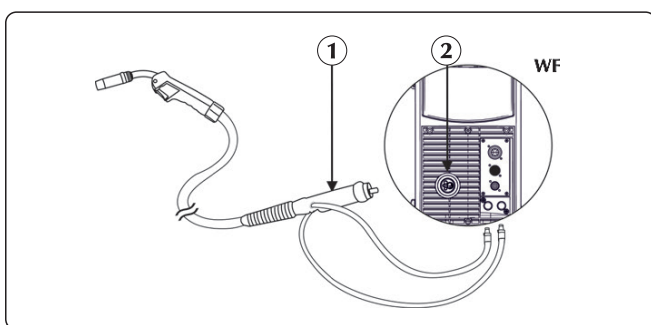

- ① Conector de pinça de ligação à terra
- ② Tomada negativa de potência (-)

- ▶ Ligar o grampo de massa à tomada negativa (-) da fonte de alimentação. Inserir a ficha e rodar no sentido dos ponteiros do relógio até fixar.



- ① Conexão da tocha
- ② Conectore

- ▶ Ligar o tubo de água da tocha (azul escuro ) ao conector rápido de saída da unidade de refrigeração.
- ▶ Ligar o tubo de água da tocha (vermelho) ao conector rápido de entrada da unidade (vermelho ) de refrigeração.
- ▶ Ligar a tocha MIG/MAG ao adaptador central, tendo o cuidado de aparafusar completamente o anel de fixação.

PT

3. APRESENTAÇÃO DO SISTEMA

3.1 Painel traseiro

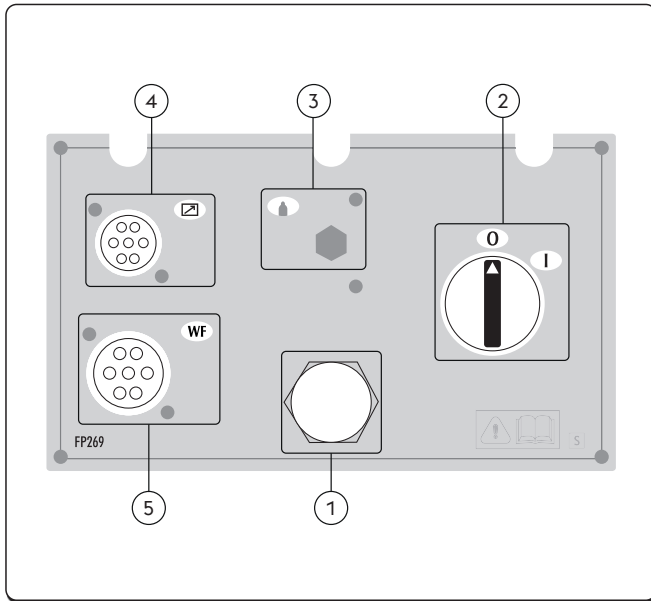

- ① **Cabo de alimentação**
Liga o sistema à rede eléctrica.
- ② **Interruptor para ligar e desligar a máquina**
Activa a energia eléctrica na máquina.
Tem duas posições, “O” desligada e “I” ligada.
- ③ **Não usado**
- ④ **Entrada do CAN-BUS cabo de sinal (RC, RI...)**
- ⑤ **Jelkábel bemenet (CAN-BUS) (kábelkötég)**

3.2 Painel de tomadas

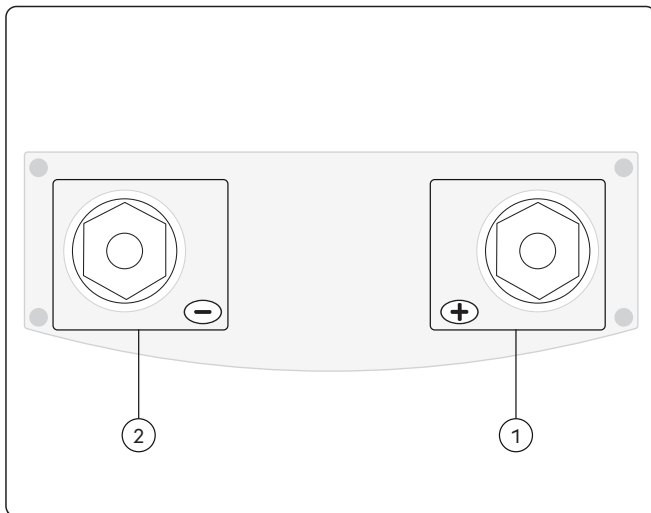

- ① **Tomada positiva de potência (+)**
Processo MMA: Conexão tocha eletrodo
Processo TIG: Conexão cabo terra
- ② **Tomada negativa de potência (-)**
Processo MMA: Conexão cabo terra
Processo TIG: Conexão tocha
Processo MIG/MAG: Conexão cabo terra

3.3 Painel de comandos frontal

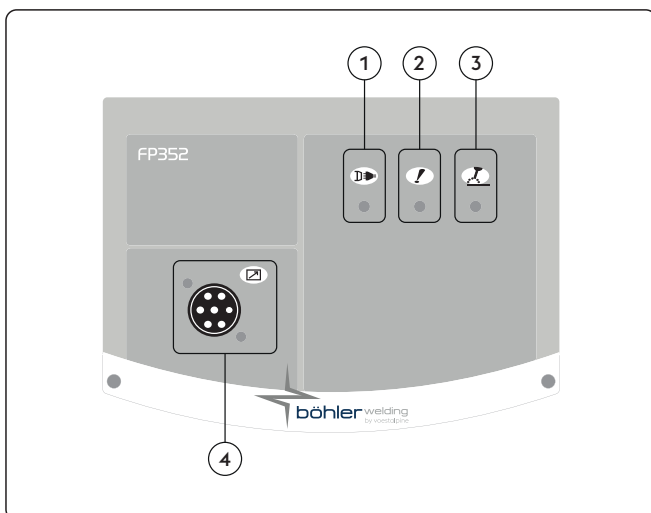





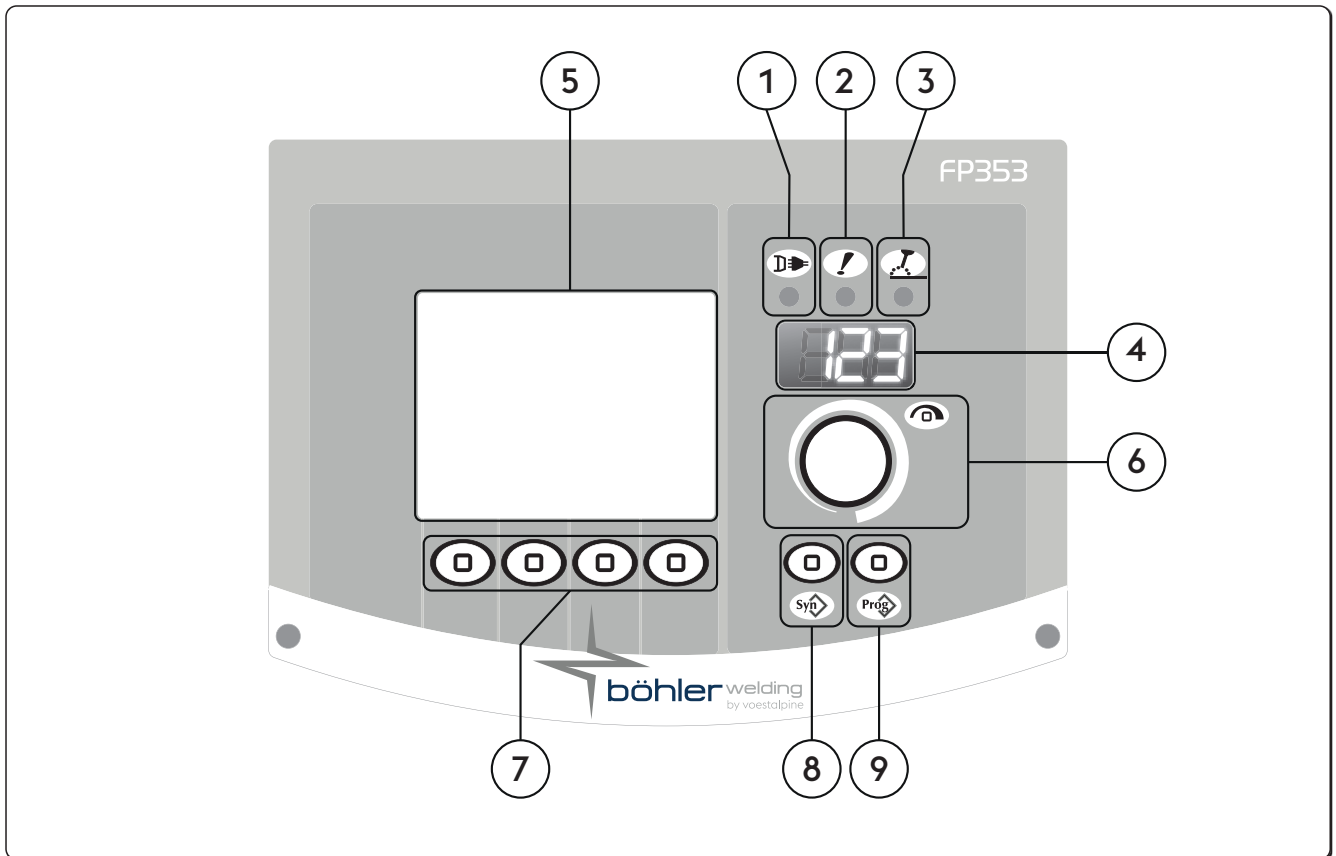

- ① **LED de alimentação**
Indica que o equipamento está ligado à fonte de alimentação e se encontra activo.
- ② **LED de alarme geral**
Indica a eventual intervenção de dispositivos de protecção, como a protecção de temperatura.
- ③ **LED de potência activa**
Indica a presença de potência nas ligações de saída do equipamento.
- ④ **Entrada do CAN-BUS cabo de sinal (RC, RI...)**

PT

3.4 Painel de comandos frontal



- 1  **LED de alimentação**
Indica que o equipamento está ligado à fonte de alimentação e se encontra activo.
- 2  **LED de alarme geral**
Indica a eventual intervenção de dispositivos de protecção, como a protecção de temperatura.
- 3  **LED de potência ativa**
Indica a presença de potência nas ligações de saída do equipamento.
- 4  **Visor de 7 segmentos**
Permite que sejam apresentados os parâmetros gerais da máquina de soldar, durante a inicialização, a definição, a leitura da corrente e da potência, bem como durante a soldadura e codificação dos alarmes.
- 5  **Visor LCD**
Permite que sejam apresentados os parâmetros gerais da máquina de soldar, durante a inicialização, a definição, a leitura da corrente e da potência, bem como durante a soldadura e codificação dos alarmes. Permite que todas as operações sejam apresentadas instantaneamente.
- 6  **Manípulo de regulação principal**
Permite a acesso à configuração, selecção e definição dos parâmetros de soldadura.
- 7  **Funkcióbillentyűk**
Permite seleccionar as diversas funções do sistema:
 - Processo de soldadura
 - Métodos de soldadura
 - Pulsação de corrente
 - Modo gráfico



8 Programok gomb

Permite seleccionar um programa de soldadura predefinido, escolhendo algumas definições simples:

- Tipo di fio
- Tipo de gás
- Diâmetro do fio



9 Botão job

Permite o armazenamento e gestão de 240 programas de soldadura, que podem ser personalizados pelo operador.

4. UTILIZAÇÃO DO EQUIPAMENTO

4.1 Ecrã inicial

Ao ser ligado, o gerador executa uma série de verificações, para garantir que o sistema e todos os dispositivos que lhe estão ligados funcionam correctamente. Nesta fase, o teste de gás também é executado para verificar a correcta ligação ao sistema de alimentação de gás.

4.2 Ecrã de teste

Enquanto o painel lateral (compartimento da bobina) estiver aberto, as operações de soldadura estão inibidas. O ecrã de teste afixa-se no visor LCD.

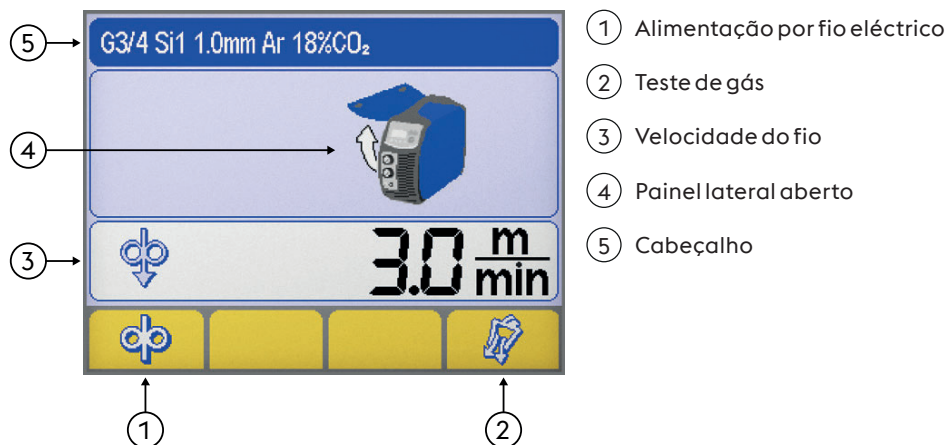

PT



Alimentação por fio eléctrico

Permite o avanço manual do fio na ausência do fluxo de gás e de alimentação eléctrica. Permite que o fio seja introduzido na bainha da tocha durante as fases de preparação da soldadura.



Teste de gás

Permite que o circuito de gás seja limpo de impurezas, bem como a obtenção da pressão de gás preliminar adequada e a realização de ajustes do fluxo, sem potência de saída.



Velocidade do fio

Permite a regulação da velocidade de avanço do fio (durante a fase de carregamento).

Mínimo	Máximo	Predefinido
0.5 m/min	22.0 m/min	3.0 m/min



Painel lateral aberto



Cabeçalho

Permite a apresentação de determinados elementos de informação importantes, relativos ao processo seleccionado.

4.3 Ecrã principal

Permite o controlo do sistema e do processo de soldadura, apresentando as definições principais.

4.4 Az MMA folyamat főképernyője

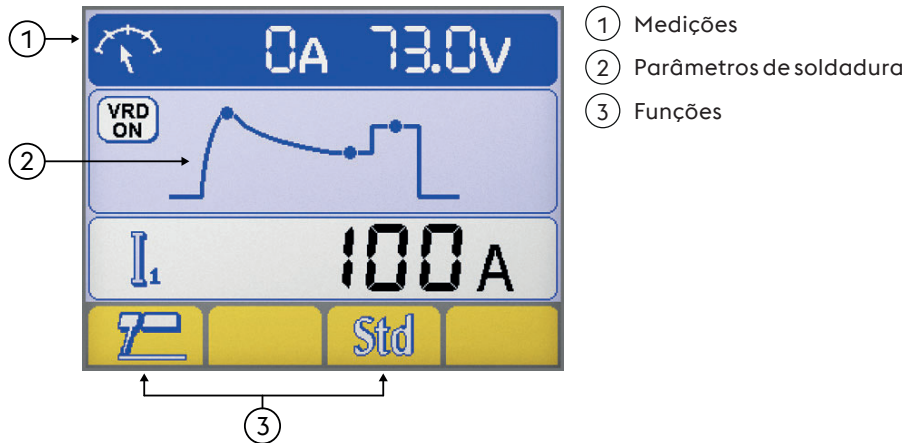

- ① Medições
- ② Parâmetros de soldadura
- ③ Funções

Medições

Durante a operação de soldadura, os valores reais de corrente e de tensão são apresentados no visor LCD.

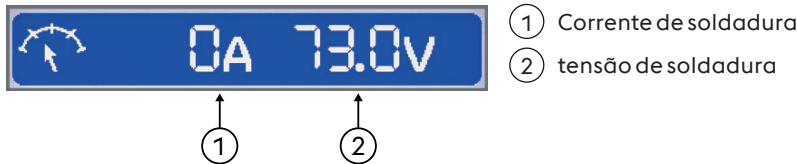

Parâmetros de soldadura

► Premir a tecla de codificação ("encoder"), para seleccionar o parâmetro pretendido.

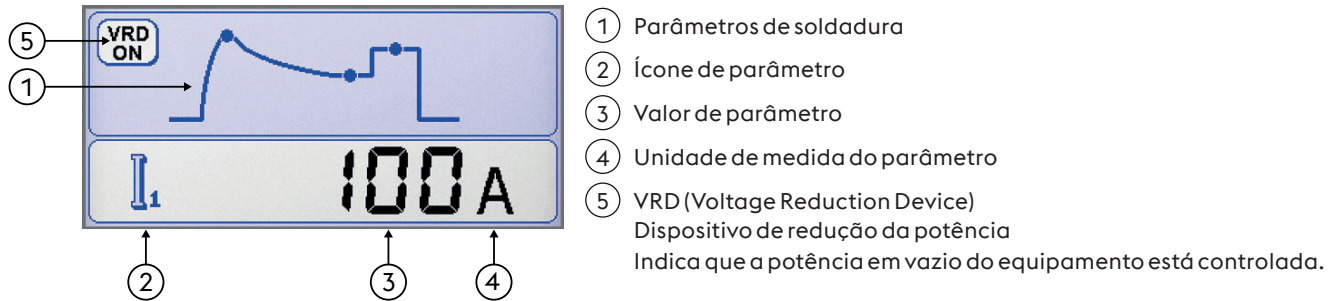

Funções

Permite a definição das funções de processo e métodos de soldadura mais importantes.

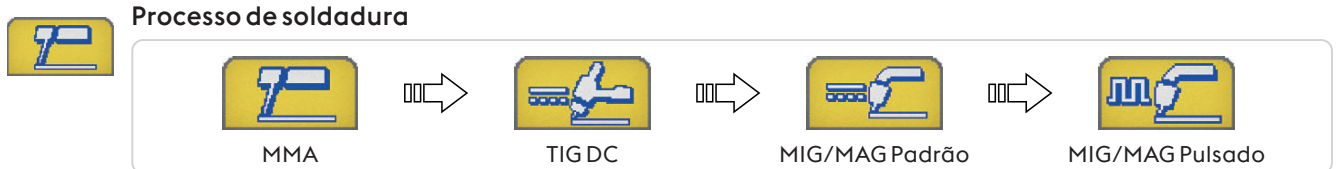

PT



Sinergia MMA

Permite definir a melhor dinâmica do arco seleccionando o tipo de eléctrodo utilizado.

Seleccionar correctamente a dinâmica do arco permite maximizar os benefícios provenientes do gerador, com o objectivo de obter o melhor desempenho de soldadura possível.



A perfeita soldabilidade do eléctrodo utilizado não é garantida

A soldabilidade depende da qualidade dos consumíveis e do respectivo estado de conservação, das condições de funcionamento e de soldadura, de numerosas aplicações possíveis, etc.

4.5 TIG folyamat főképernyő

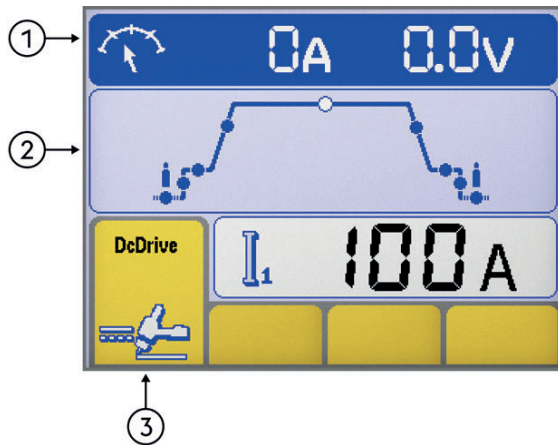

- ① Medições
- ② Parâmetros de soldadura
- ③ Funções

PT

Medições

Durante a operação de soldadura, os valores reais de corrente e de tensão são apresentados no visor LCD.

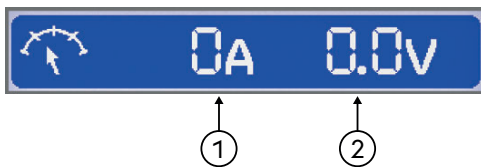

- ① Corrente de soldadura
- ② tensão de soldadura

Parâmetros de soldadura

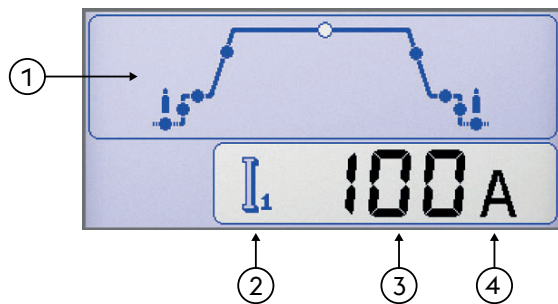

- ① Parâmetros de soldadura
 - ▶ Premir a tecla de codificação ("encoder"), para seleccionar o parâmetro pretendido.
 - ▶ Rodar a tecla de codificação ("encoder"), para regular o valor do parâmetro seleccionado.
- ② Ícone de parâmetro
- ③ Valor de parâmetro
- ④ Unidade de medida do parâmetro

Funções

Permite a definição das funções de processo e métodos de soldadura mais importantes.

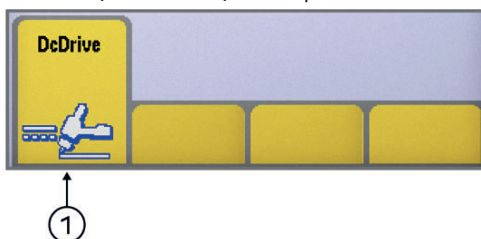

- ① Processo de soldadura



Processo de soldadura



4.6 MIG/MAG folyamat főképernyő

Alap képernyő

① Cabeçalho MIG/MAG
 ② Parâmetros de soldadura
 ③ Funções

Grafikus képernyő

① Cabeçalho MIG/MAG
 ② Parâmetros de soldadura
 ③ Funções

Cabeçalho MIG/MAG

Permite a apresentação de determinados elementos de informação importantes, relativos ao processo seleccionado.

G3/4 Si1 1.0mm Ar 18%CO₂

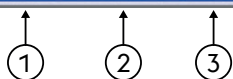

Curva sinérgica seleccionada

- ① Tipo de material de adição
- ② Diâmetro do fio
- ③ Tipo de gás

I 118A 2.2mm 3.4mm V 19.5V

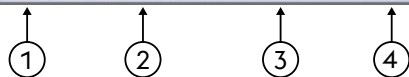

Parâmetros de soldadura

- ① Corrente de soldadura
- ② Espessura da peça de trabalho
- ③ Cordão de canto
- ④ tensão de soldadura

PT

Parâmetros de soldadura (Alap képernyő)

► Premir a tecla de codificação (“encoder”), para seleccionar o parâmetro pretendido.

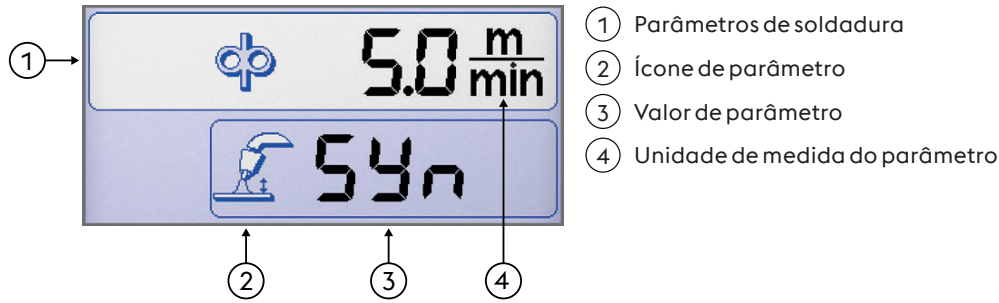

- ① Parâmetros de soldadura
- ② Ícone de parâmetro
- ③ Valor de parâmetro
- ④ Unidade de medida do parâmetro

Parâmetros de soldadura (Grafikus képernyő)

► Premir a tecla de codificação (“encoder”), para seleccionar o parâmetro pretendido.

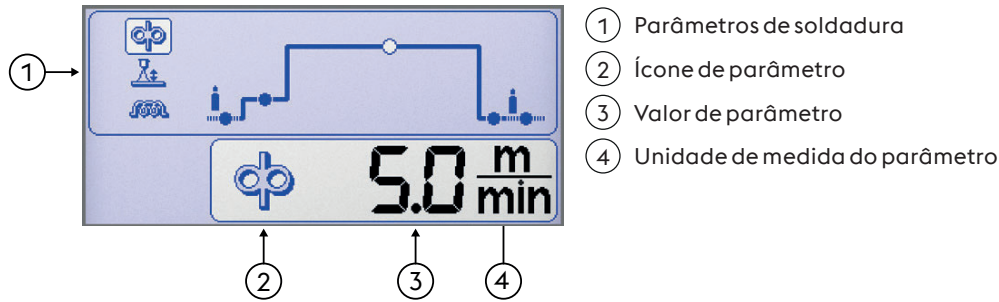

- ① Parâmetros de soldadura
- ② Ícone de parâmetro
- ③ Valor de parâmetro
- ④ Unidade de medida do parâmetro

Funções

Permite a definição das funções de processo e métodos de soldadura mais importantes.

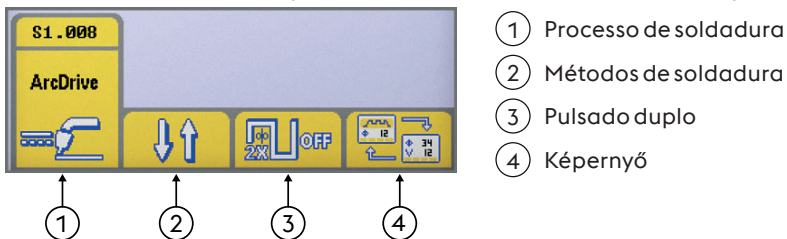

- ① Processo de soldadura
- ② Métodos de soldadura
- ③ Pulsado duplo
- ④ Képernyő

Processo de soldadura



Métodos de soldadura

Permite a selecção do método de soldadura



2 Fases

Em duas fases, carregar no botão provoca o fluxo de gás, alimenta potência ao fio e fá-lo avançar; ao ser solto, o gás, a potência e o avanço de fio são desligados.



4 Fases

Em quatro fases, a primeira vez que se carrega no botão provoca o fluxo de gás, executando o período de pré-gás manual; quando é solto, activa a potência no fio e o mecanismo de avanço de fio. A segunda vez que se carrega no botão faz parar o fio e provoca o início do processo final, o que repõe a corrente a zero; no final, quando o botão é solto, o fluxo de gás é desactivado.



Crater filler

Permite que a soldadura seja feita com três tipos diferentes de potência, com a capacidade de serem directamente seleccionados e controlados pelo soldador, através do botão da tocha.

A primeira vez que se carrega no botão provoca o fluxo de gás, activa a potência no fio e fá-lo avançar à velocidade definida pelo parâmetro “incremento inicial” (durante a configuração), com os valores sinérgicos relativos dos parâmetros de soldadura.

Quando o botão da tocha é solto, a velocidade do fio e os parâmetros sinérgicos relativos são alterados automaticamente para os valores principais, definidos no painel de controlo.

Quando se carrega novamente no botão da tocha, a velocidade do fio e os parâmetros sinérgicos relativos são repostos nos valores predefinidos de parâmetro de enchimento de cratera (durante a configuração).

Soltar o botão da tocha desactiva o avanço do fio e fornece a alimentação para as fases de “burnback” e pós-gás.

Pulsado duplo

Pulsado duplo activo

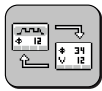

Pulsado duplo inactivo

Képernyő

Lehetővé teszi a megjelenítés váltását:



Alap képernyő







Grafikus képernyő

Ecrã de curvas sinérgicas

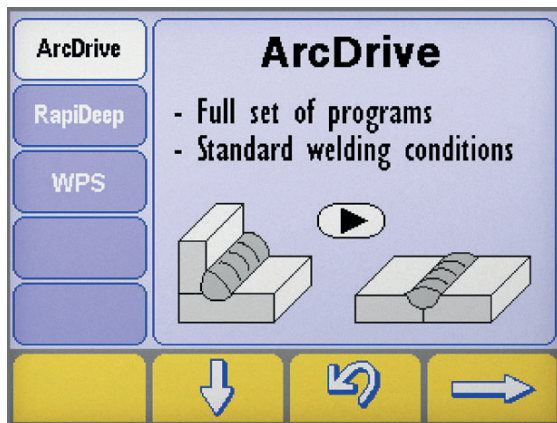
Sinergia

Permite seleccionar um programa de soldadura predefinido (sinergia), escolhendo algumas definições simples

Hegesztési folyamat kiválasztása

- ▶ Lépjen be a „szinergiák” képernyőbe úgy, hogy nyomva tartja a gombot  legalább egy másodpercig.
- ▶ Válassza ki a kívánt folyamatot a gombok megnyomásával  e .
- ▶ Premir o botão  para avançar para o passo seguinte.

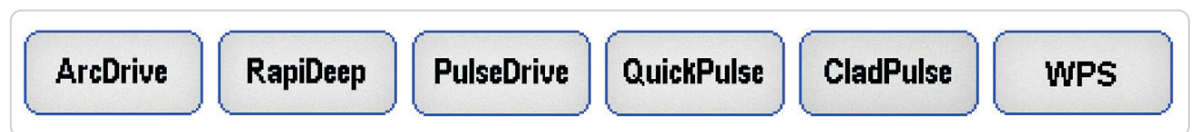
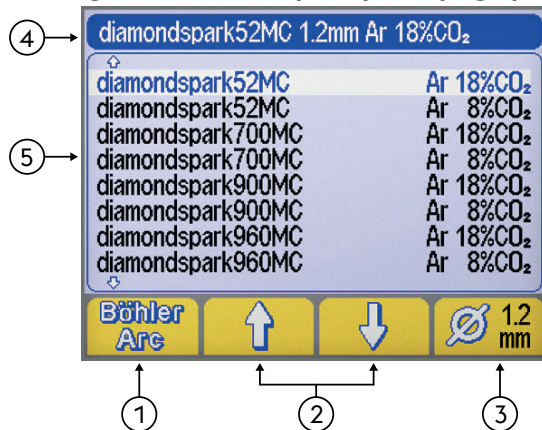
Processo de soldadura

Szinergia választó képernyő Anyagtípus/Gáztípus

- ① Programa de soldadura (BöhlerArc/UniversalArc)
- ② Anyag/gáz kiválasztása
- ③ Diâmetro do fio
- ④ Cabeçalho
- ⑤ Programa de soldadura

Programa de soldadura

Permite a selecção do programa de soldadura



BöhlerArc



UniversalArc

Anyag/gáz kiválasztása

Permite seleccionar:



- Tipo de material de adição
- Tipo de gás



Diâmetro do fio

Permite a selecção do diâmetro do fio utilizado (mm).

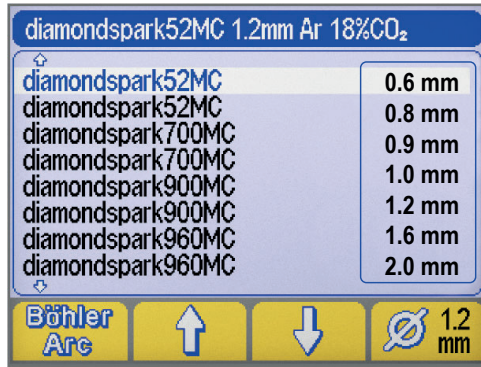

① Diâmetro do fio

①



Cabeçalho

Permite a apresentação de determinados elementos de informação importantes, relativos ao processo seleccionado.



NO PROGRAM (sem programa)

Indica que o programa sinérgico seleccionado não está disponível ou não é consistente com as restantes definições do sistema.

4.7 Ecrã de programas



Permite o armazenamento e gestão de 240 programas de soldadura, que podem ser personalizados pelo operador.

PT

Programas (JOB)

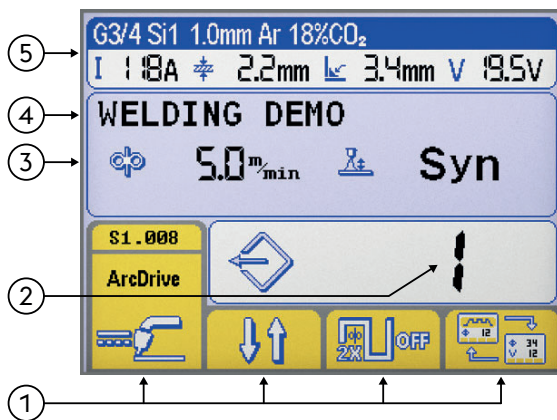

① Funções

② Número do programa seleccionado

③ Parâmetros principais do programa seleccionado

④ Descrição do programa seleccionado

⑤ Cabeçalho

Consultar a secção "Ecrã principal"

Armazenamento de programas

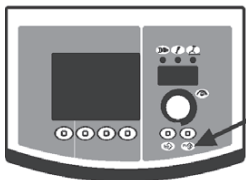

► Carregar no botão para aceder ao menu "armazenamento de programas". legalább egy másodpercig.



- ▶ Rodar a tecla de codificação ("encoder"), para seleccionar o programa pretendido (ou a memória vazia).

--- Memória vazia

Programa armazenado

- ▶ Carregar no botão, para confirmar a operação .
- ▶ Carregar no botão, para salvar todas as definições actuais no programa seleccionado. .

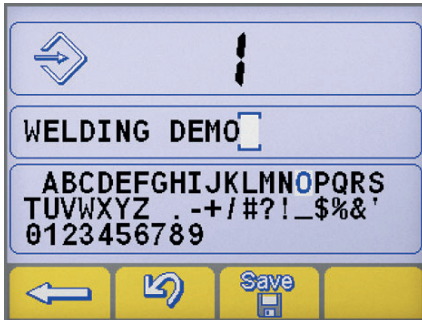

Introduzir uma descrição do programa.

- ▶ Rodar a tecla de codificação ("encoder"), para seleccionar a letra pretendida.
- ▶ Premir a tecla de codificação ("encoder"), para armazenar a letra pretendida.
- ▶ Carregar no botão, para anular a última letra. .
- ▶ Carregar no botão, para confirmar a operação .
- ▶ Carregar no botão, para confirmar a operação .



O armazenamento de um novo programa num local da memória já ocupado, requer que esse local da memória seja cancelado, através de um procedimento obrigatório.



- ▶ Carregar no botão, para confirmar a operação .
- ▶ Carregar no botão, para remover o programa seleccionado. .
- ▶ Retomar o processo de armazenamento.

Recuperação de programas

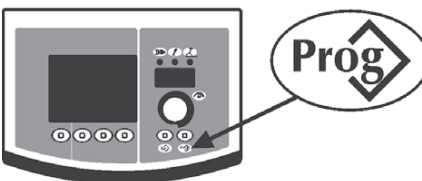

- ▶ Carregar no botão, para recuperar o 1º programa disponível .
- ▶ Rodar a tecla de codificação ("encoder"), para seleccionar o programa pretendido.
- ▶ Carregar no botão, para seleccionar o programa pretendido. .



São recuperados apenas os locais da memória ocupados por um programa, sendo automaticamente ignorados os locais vazios.



Cancelamento de programas



- ▶ Rodar a tecla de codificação ("encoder"), para seleccionar o programa pretendido.
- ▶ Carregar no botão, para remover o programa seleccionado. .
- ▶ Carregar no botão, para confirmar a operação .

PT



- ▶ Carregar no botão, para confirmar a operação .
- ▶ Carregar no botão, para remover o programa seleccionado. .

5. DEFINIÇÕES

5.1 Definições e definição dos parâmetros

Permite a definição e a regulação de uma série de parâmetros adicionais para um controlo melhorado e mais preciso do sistema de soldadura.

Os parâmetros presentes nas definições estão organizados em função do processo de soldadura seleccionado e possuem um código numérico.

Acesso a definições





- ▶ Carregar durante 5 segundos no botão encoder.
- ▶ A introdução será confirmada pela inscrição 0 que surge no visor.

PT

Seleção e regulação do parâmetro desejado

- ▶ Rodar a tecla de codificação (“encoder”) até visualizar o código numérico relativo ao parâmetro.
- ▶ Neste momento, carregar na tecla de codificação permite a visualização do valor definido para o parâmetro seleccionado e a respectiva regulação.

Saída de definições

- ▶ Para sair da secção “regulação” premir novamente a tecla de codificação.
- ▶ Para sair de definições, aceder ao parâmetro “0” (guardar e sair) e premir a tecla de codificação.
- ▶ Carregar no botão, para confirmar a operação .
- ▶ Para guardar a alteração e sair da configuração, premir o botão: .

5.1.1 Lista dos parâmetros de definições (MMA)

0

Guardar e sair



Permite guardar as modificações e sair de definições.

1

Reset



Permite redefinir todos os parâmetros para os valores predefinidos.

3

Hot start



Permite regular o valor de “hot start” em MMA.

Permite um início mais ou menos quente nas fases de ignição do arco, facilitando as operações iniciais.

Eléctrodo básico

Eléctrodo celulósico

Mínimo	Máximo	Predefinido
0/off	500%	80%

Mínimo	Máximo	Predefinido
0/off	500%	150%

Eléctrodo CrNi

Mínimo	Máximo	Predefinido
0/off	500%	100%

Eléctrodo de alumínio

Mínimo	Máximo	Predefinido
0/off	500%	120%

Eléctrodo de ferro fundido

Mínimo	Máximo	Predefinido
0/off	500%	100%

7
Corrente de soldadura

Permite regular a corrente de soldadura.



Mínimo	Máximo	Predefinido
3 A	I _{max}	100 A

8
Arc force

Permite regular o valor do "Arc force" em MMA.

Permite uma resposta dinâmica mais ou menos energética em soldadura, facilitando as operações realizadas pelo soldador.

Aumentar o valor da força do arco para reduzir o risco de colagem do eléctrodo.

Eléctrodo básico

Mínimo	Máximo	Predefinido
0/off	500%	30%

Eléctrodo celulósico

Mínimo	Máximo	Predefinido
0/off	500%	350%

Eléctrodo CrNi

Mínimo	Máximo	Predefinido
0/off	500%	30%

Eléctrodo de alumínio

Mínimo	Máximo	Predefinido
0/off	500%	100%

Eléctrodo de ferro fundido

Mínimo	Máximo	Predefinido
0/off	500%	70%

204
Dynamic power control (DPC)

Permite seleccionar a característica V/I pretendida.

I=C Corrente constante

O aumento ou redução da altura do arco não tem efeito na corrente de soldadura necessária.

Recomendado para eletrodo: Básico, Rutilico, Ácido, Aço, Ferro fundido

1:20 Diminuição do controlo de gradiente

O aumento da altura do arco provoca uma redução da corrente de soldadura (e vice-versa), de acordo com o valor determinado por 1 para 20 amperes por volt.

Recomendado para eletrodo: Celulósico, Alumínio

P=C Potência constante

 O aumento da altura do arco provoca uma redução da corrente de soldadura (e vice-versa), de acordo com a lei: $V \cdot I = K$

Recomendado para eletrodo: Celulósico, Alumínio

312
Tensão de extinção do arco

Permite definir o valor de tensão que, ao ser atingido, força a extinção do arco eléctrico.

Permite uma melhor gestão das várias condições de funcionamento ocorridas.

Na fase de soldadura por pontos, por exemplo, uma baixa tensão de extinção do arco possibilita uma menor produção de chama no afastamento do eléctrodo da peça reduzindo salpicos, queimaduras e oxidação da peça.

No caso da utilização de eléctrodos que necessitam de altas tensões é aconselhável, pelo contrário, definir um limite alto, para evitar que o arco se extinga durante a soldadura.

Nunca definir uma tensão de extinção do arco maior do que a tensão em vazio do gerador.
Eléctrodo básico

Mínimo	Máximo	Predefinido
0/off	99.9 V	57.0 V

Eléctrodo celulósico

Mínimo	Máximo	Predefinido
0/off	99.9 V	70.0 V

PT

399 Velocidade de corte

Permite definir a velocidade de soldadura.

Default cm/min: velocidade de referência para soldadura manual.

Syn: valor sinérgica.

Mínimo	Máximo	Predefinido
1 cm/min	200 cm/min	15 cm/min

500 Configuração da máquina

Permite seleccionar a interface gráfica pretendida.

Permite aceder aos níveis de definição superiores.

Consultar a secção "Personalização da interface (Set up 500)"

Valor	Interface do Utilizador
XE	Modo Básico
XA	Modo Avançado
XP	Modo Profissional

Valor	Nível seleccionado
USER	Utilizador
SERV	Service
vaBW	vaBW

551 Lock/unlock

Permite o bloqueio dos controlos do painel e a introdução de um código de protecção.

Consultar a secção "Lock/unlock (Set up 551)".

552 Tom avisador sonoro

Permite a regulação do tom avisador sonoro.

Mínimo	Máximo	Predefinido
0/off	10	10

601 Passo de regulação

Permite a regulação de um parâmetro, com um passo que pode ser personalizado pelo operador.

Mínimo	Máximo	Predefinido
1	Imax	1

602 Parâmetro externo CH1, CH2, CH3, CH4

Permite a gestão do parâmetro externo 1, 2, 3, 4 (valor mínimo, valor máximo, valor predefinido, parâmetro seleccionado).

Consultar a secção "Gestão de controlos externos (Set up 602)".

705 Calibração da resistência do circuito

Permite calibrar o equipamento.

Consultar a secção "Calibração da resistência do circuito (set up 705)".

751 Leitura de corrente

Permite a apresentação do valor real da corrente de soldadura.

752 Leitura de tensão

Permite a apresentação do valor real da tensão de soldadura.

768 Medição da aportação de calor HI

Permite ler o valor medido da aportação de calor durante a soldadura.

5.1.2 Lista de parâmetros na configuração (TIG)**0****Guardar e sair**

Permite guardar as modificações e sair de definições.

1 Reset

Permite redefinir todos os parâmetros para os valores predefinidos.

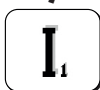
7 Corrente de soldadura

Permite regular a corrente de soldadura.

Mínimo	Máximo	Predefinido
3 A	I _{max}	100 A

399 Velocidade de corte

Permite definir a velocidade de soldadura.

Default cm/min: velocidade de referência para soldadura manual.

Syn: valor sinérgica.

Mínimo	Máximo	Predefinido
1 cm/min	200 cm/min	10 cm/min

500 Configuração da máquina

Permite seleccionar a interface gráfica pretendida.

Permite aceder aos níveis de definição superiores.

Consultar a secção "Personalização da interface (Set up 500)"

Valor	Interface do Utilizador
XE	Modo Básico
XA	Modo Avançado
XP	Modo Profissional

Valor	Nível seleccionado
USER	Utilizador
SERV	Service
vaBW	vaBW

551 Lock/unlock

Permite o bloqueio dos controlos do painel e a introdução de um código de protecção.

Consultar a secção "Lock/unlock (Set up 551)".

552 Tom avisador sonoro

Permite a regulação do tom avisador sonoro.

Mínimo	Máximo	Predefinido
0/off	10	10

601 Passo de regulação

Permite a regulação de um parâmetro, com um passo que pode ser personalizado pelo operador.

Mínimo	Máximo	Predefinido
1	I _{max}	1

602 Parâmetro externo CH1, CH2, CH3, CH4

Permite a gestão do parâmetro externo 1, 2, 3, 4 (valor mínimo, valor máximo, valor predefinido, parâmetro seleccionado).

Consultar a secção "Gestão de controlos externos (Set up 602)".

705 Calibração da resistência do circuito

Permite calibrar o equipamento.

Consultar a secção "Calibração da resistência do circuito (set up 705)".

751 Leitura de corrente

Permite a apresentação do valor real da corrente de soldadura.

752 Leitura de tensão

Permite a apresentação do valor real da tensão de soldadura.

PT

755 **Leitura do fluxo de gás (WFR)**

Permite a apresentação do fluxo de gás real.

757 **Leitura de velocidade do fio**

Permite visualizar o valor do codificador do motor 1.

760 **Leitura de corrente (motor 1)**

Permite a apresentação do valor real da corrente (motor 1).

764 **Medição do fluxo do líquido de refrigeração**

Permite visualizar o valor do fluxo do líquido de refrigeração.

765 **Leitura de temperatura do líquido de refrigeração**

Permite a apresentação do valor real de temperatura do líquido de refrigeração.

768 **Medição da aportação de calor HI**

Permite ler o valor medido da aportação de calor durante a soldadura.

801 **Limites de segurança**

Permite a definição dos limites de aviso e dos limites de segurança.

Permite o controlo do processo de soldadura, através da definição de limites de aviso e limites de segurança, aplicáveis aos principais parâmetros mensuráveis.

Permite o controlo preciso das várias fases de soldadura.

Consultar a secção "Limites de segurança (Set up 801)".

5.1.3 Lista de parâmetros na configuração (MIG/MAG)**0** **Guardar e sair**

Permite guardar as modificações e sair de definições.

1 **Reset**

Permite redefinir todos os parâmetros para os valores predefinidos.

2 **Sinergia****MIG/MAG Padrão:**

Permite a selecção do processo MIG manual ( Off) ou MIG sinérgico ( 6), através da definição do tipo de material a soldar.

MIG/MAG Pulsado:

Permite a selecção do processo MIG sinérgico ( 6), através da definição do tipo de material a soldar.

Permite a selecção do processo CC/CV.

3 **Velocidade do fio**

Permite a regulação da velocidade de avanço do fio.

Mínimo	Máximo	Predefinido
0.5 m/min	22.0 m/min	-

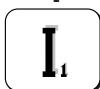
4 Corrente

Permite regular a corrente de soldadura.

Mínimo	Máximo
3 A	I _{max}

5 Espessura da peça de trabalho

Permite a definição da espessura da peça a soldar.
Possibilita a definição do sistema através da regulação da peça a ser soldada.

6 Cordão de canto "a"

Permite definir a profundidade do cordão de soldadura numa junta de canto.

7 Tensão - comprimento do arco

Permite a regulação da tensão do arco.
Permite a regulação do comprimento do arco, durante a soldadura.

Tensão alta = arco comprido

Tensão baixa = arco curto

Soldadura manual

Mínimo	Máximo	Predefinido
5.0 V	55.5 V	5.0 V

10 Pré-gás

Permite definir e regular o fluxo de gás antes da ignição do arco.
Permite o carregamento do gás na tocha e a preparação do ambiente para a soldadura.

Mínimo	Máximo	Predefinido
0/off	99.9 s	0.1 s

11 Soft start



Permite a regulação da velocidade de avanço do fio nas fases que antecedem a ignição.
Permite uma ignição a velocidade reduzida, mais suave e com menos salpicos.

Mínimo	Máximo	Predefinido
10 %	100 %	50 %

12 Rampa motor

Permite definir uma passagem gradual entre a velocidade do fio de ignição e a velocidade do fio de soldadura.

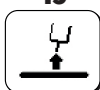
Mínimo	Máximo	Predefinido
0/off	1.0 s	0/off

15 Burn back

Permite a regulação do tempo de queima do fio, impedindo a colagem no fim da soldadura.
Permite regular o comprimento do pedaço de fio exterior à tocha.

Mínimo	Máximo	Predefinido
-2.00	+2.00	0/syn

16 Pós-gás

Permite regular o fluxo de gás no fim da soldadura.

Mínimo	Máximo	Predefinido
0/off	99.9 s	2.0 s

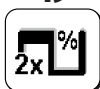
19 Duty cycle (duplo impulso)

Permite o ajuste do ciclo de trabalho em duplo impulso.

Mínimo	Máximo	Predefinido
10 %	90 %	50 %

PT

20 Pulsado duplo

Permite a regulação da amplitude de pulsação.

Mínimo	Máximo	Predefinido
0 %	100 %	±25 %
Mínimo	Máximo	Predefinido
0.5 m/min	22 m/min	2.5 m/min

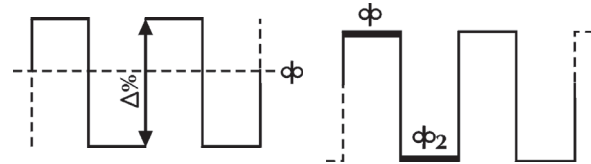
**21 Frequência de pulsação (duplo impulso)**

Permite a regulação do ciclo, isto é, do ciclo de repetição do impulso.

Permite a regulação da frequência do impulso.

Mínimo	Máximo	Predefinido
0.1 Hz	5.0 Hz	2.0 Hz

22 Tensão secundária (duplo impulso)

Permite a regulação da tensão do nível de pulsação secundário.

Possibilita a obtenção de uma maior estabilidade do arco, durante as várias fases de pulsação.

Mínimo	Máximo	Predefinido
-5.0	+5.0	0/syn

23 Declives de pulsação (duplo impulso)

Permite definir um tempo de declive, durante a operação de pulsação.

Mínimo	Máximo	Predefinido
1 %	100 %	50 %

24 Bilevel (4T - crater filler)

Permite regular a velocidade do fio secundária na modalidade de soldadura de duplo nível.

Se o soldador pressiona e solta rapidamente o botão passa-se a "φ₂".

Pressionando e soltando rapidamente o botão passa-se novamente a "φ" e assim adiante.

Mínimo	Máximo	Predefinido
1 %	200 %	0/off

25 Incremento inicial

Permite a regulação do valor de velocidade do fio durante a primeira fase de soldadura "enchimento de cratera".

Possibilita o aumento da energia fornecida à peça, na fase em que o material (ainda frio) requer mais calor, para que derreta de maneira uniforme.

Mínimo	Máximo	Predefinido
20 %	200 %	120 %

26 Crater filler

Permite a regulação do valor de velocidade do fio durante a fase de conclusão da soldadura.

Possibilita a redução da energia fornecida à peça, na fase em que o material já se encontra muito quente, reduzindo, assim, o risco de deformações indesejáveis.

Mínimo	Máximo	Predefinido
20 %	200 %	80 %

27 Tempo de incremento inicial

Permite definir o tempo de incremento inicial.

Permite automatizar a função "enchimento de cratera".

Mínimo	Máximo	Predefinido
0.1 s	99.9 s	0/off

28 Tempo de enchimento de cratera

Permite definir o tempo de "enchimento de cratera".

Permite automatizar a função "enchimento de cratera".

Mínimo	Máximo	Predefinido
0.1 s	99.9 s	0/off

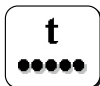
30 Soldadura por pontos

Permite a activação do processo de “soldadura por pontos” e definir o tempo de soldadura.

Mínimo	Máximo	Predefinido
0.1 s	99.9 s	0/off

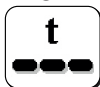
31 Ponto pausa

Permite activar o processo “ponto pausa” e estabelecer o tempo de pausa entre uma soldadura e a outra.

Mínimo	Máximo	Predefinido
0.1 s	99.9 s	0/off

32 Tensão secundária (Duplo nível MIG)

Permite a regulação da tensão do nível de pulsação secundário.

Possibilita a obtenção de uma maior estabilidade do arco, durante as várias fases de pulsação.

Mínimo	Máximo	Predefinido
-5.0	+5.0	0/syn

33 Indutância secundária (Duplo nível MIG)

Permite a regulação da indutância do nível de pulsação secundário.

Possibilita a obtenção de um arco mais ou menos rápido, para compensar os movimentos do soldador e a instabilidade natural da soldadura.

Indutância baixa = arco reactivo (mais salpicos).

Indutância alta = arco menos reactivo (menos salpicos).

Mínimo	Máximo	Predefinido
-30	+30	0/syn

34 Rampa de subida inicial

Permite definir uma transição gradual entre a velocidade inicial do fio e a velocidade de soldadura do fio.

Mínimo	Máximo	Predefinido
0 s	10 s	0/off

35 Rampa de enchimento da cratera

Permite definir uma transição gradual entre a velocidade de soldadura do fio e a velocidade de enchimento da cratera.

Mínimo	Máximo	Predefinido
0 s	10 s	0/off

202 Indutância

Permite a regulação electrónica da indutância série do circuito de soldadura.

Possibilita a obtenção de um arco mais ou menos rápido, para compensar os movimentos do soldador e a instabilidade natural da soldadura.

Indutância baixa = arco reactivo (mais salpicos).

Indutância alta = arco menos reactivo (menos salpicos).

Mínimo	Máximo	Predefinido
-30	+30	0/syn

331 Tensão média compensada

Permite definir a tensão de soldadura.

399 Velocidade de corte

Permite definir a velocidade de soldadura.

Default cm/min: velocidade de referência para soldadura manual.

Syn: valor sinérgica.

Mínimo	Máximo	Predefinido
syn min	syn max	35 cm/min

PT

500 Configuração da máquina

Permite seleccionar a interface gráfica pretendida.
Permite aceder aos níveis de definição superiores.
Consultar a secção "Personalização da interface (Set up 500)"

Valor	Interface do Utilizador
XE	Modo Básico
XA	Modo Avançado
XP	Modo Profissional

Valor	Nível seleccionado
USER	Utilizador
SERV	Service
vaBW	vaBW

551 Lock/unlock

Permite o bloqueio dos controlos do painel e a introdução de um código de protecção.
Consultar a secção "Lock/unlock (Set up 551)".

552 Tom avisador sonoro

Permite a regulação do tom avisador sonoro.

Mínimo	Máximo	Predefinido
0/off	10	10

601 Passo de regulação

Permite a regulação de um parâmetro, com um passo que pode ser personalizado pelo operador.
Funcionalidade controlada pelo botão para cima / para baixo da tocha.

Mínimo	Máximo	Predefinido
1	Imax	1

602 Parâmetro externo CH1, CH2, CH3, CH4

Permite a gestão do parâmetro externo 1, 2, 3, 4 (valor mínimo, valor máximo, valor predefinido, parâmetro seleccionado).

Consultar a secção "Gestão de controlos externos (Set up 602)".

606 Tocha U/D

Permite a gestão do parâmetro externo (U/D).

Valor	Predefinido	Função de retorno de chamada
0/off	-	off
1/11	X	Corrente
	-	Recuperação de programas

705 Calibração da resistência do circuito

Permite calibrar o equipamento.
Consultar a secção "Calibração da resistência do circuito (set up 705)".

751 Leitura de corrente

Permite a apresentação do valor real da corrente de soldadura.

752 Leitura de tensão

Permite a apresentação do valor real da tensão de soldadura.

755 Leitura do fluxo de gás (WFR)

Permite a apresentação do fluxo de gás real.

757 Leitura de velocidade do fio

Permite visualizar o valor do codificador do motor 1.

- 758 Velocidade de movimentação de robô**
 Permite a apresentação da velocidade de movimentação de um braço robotizado ou automatizado.
- 760 Leitura de corrente (motor 1)**
 Permite a apresentação do valor real da corrente (motor 1).
- 761 Leitura de velocidade do fio**
 Permite visualizar o valor do codificador do motor 2.
- 762 Leitura de corrente (motor 2)**
 Permite a apresentação do valor real da corrente (motor 2).
- 763 Leitura de velocidade do fio**
 Permite visualizar o valor real da velocidade do fio.
- 764 Medição do fluxo do líquido de refrigeração**
 Permite visualizar o valor do fluxo do líquido de refrigeração.
- 765 Leitura de temperatura do líquido de refrigeração**
 Permite a apresentação do valor real de temperatura do líquido de refrigeração.
- 768 Medição da aportação de calor HI**
 Permite ler o valor medido da aportação de calor durante a soldadura.
- 801 Limites de segurança**
 Permite a definição dos limites de aviso e dos limites de segurança.
 Permite o controlo do processo de soldadura, através da definição de limites de aviso e limites de segurança, aplicáveis aos principais parâmetros mensuráveis.
 Permite o controlo preciso das várias fases de soldadura.
 Consultar a secção "Limites de segurança (Set up 801)".

PT

5.2 Procedimentos específicos de utilização dos parâmetros

5.2.1 Personalização do visor de 7 segmentos

Permite ver constantemente o valor de um parâmetro no visor de 7 segmentos.

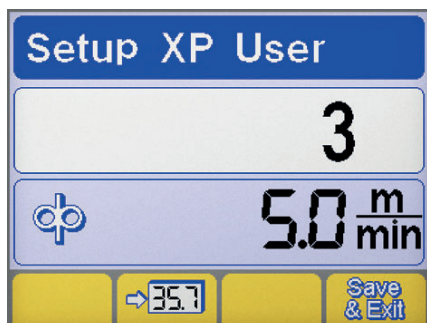

- ▶ Premir a tecla de codificação ("encoder") durante, pelo menos, 5 segundos, para aceder às definições.
- ▶ Rodar a tecla de codificação ("encoder").
- ▶ Carregar no botão, para armazenar o parâmetro seleccionado no visor de 7 segmentos **35.7**.
- ▶ Carregar no botão, para salvar e sair do ecrã actual **Save & Exit**.

5.2.2 Personalização da interface (Set up 500)

Permite que os parâmetros sejam personalizados no menu principal.

500

Configuração da máquina

Permite seleccionar a interface gráfica pretendida.



Valor	Interface do Utilizador
XE	Modo Básico
XA	Modo Avançado
XP	Modo Profissional

MODO XE

MMA	
Parâmetros de soldadura	
TIG	
Parâmetros de soldadura	
Funções	
MIG/MAG	
Parâmetros de soldadura	
Funções	

MODO XA

MMA	
Parâmetros de soldadura	
Funções	
TIG	
Parâmetros de soldadura	
Funções	
MIG/MAG	
Parâmetros de soldadura	
Funções	

MODO XP

MMA	
Parâmetros de soldadura	
Funções	

PT

TIG	
Parâmetros de soldadura	
Funções	
MIG/MAG	
Parâmetros de soldadura	
Funções	

5.2.3 Lock/unlock (Set up 551)

Permite o bloqueio dos controlos do painel e a introdução de um código de protecção.

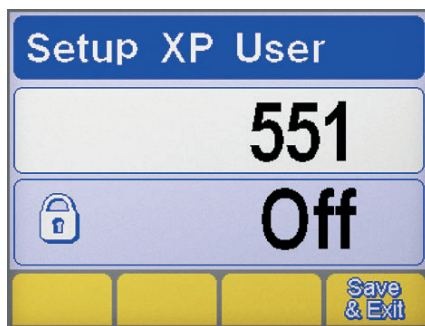

Seleção de parâmetro

- ▶ Premir a tecla de codificação (“encoder”) durante, pelo menos, 5 segundos, para aceder às definições.
- ▶ Seleccionar o parâmetro pretendido (551).
- ▶ Premir a tecla de codificação (“encoder”), para activar a regulação do parâmetro seleccionado.

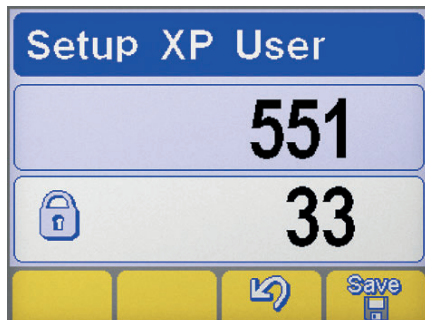

- ▶ Rodar a tecla de codificação (“encoder”), para definir um código numérico (palavra-passe).
- ▶ Premir o botão-encoder para confirmar a operação.
- ▶ Carregar no botão, para confirmar a operação
- ▶ Para guardar a alteração, premir o botão:

Funções do painel



A execução de qualquer operação num painel de controlo bloqueado faz surgir um ecrã especial.

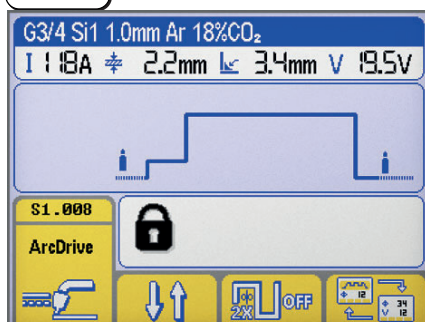

- ▶ Rodar a tecla de codificação (“encoder”) e introduzir a palavra-passe correcta, para aceder temporariamente às funcionalidades do painel (5 minutos).
- ▶ Premir o botão-encoder para confirmar a operação.
- ▶ Aceder às definições (seguir as instruções dadas acima) e repor o parâmetro 551 em “off”, para desbloquear definitivamente o painel de controlo
- ▶ Premir o botão-encoder para confirmar a operação.
- ▶ Para guardar a alteração, premir o botão:

PT

5.2.4 Gestão de controlos externos (Set up 602)

Permite a gestão do parâmetro externo 2 (valor mínimo, valor máximo, valor predefinido, parâmetro seleccionado).

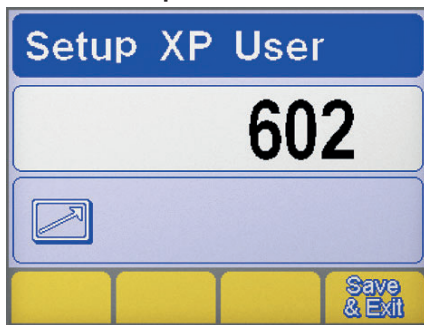

Seleção de parâmetro

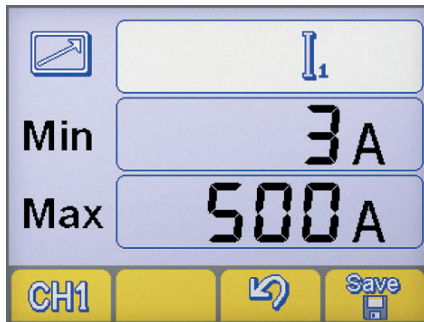

- ▶ Premir a tecla de codificação ("encoder") durante, pelo menos, 5 segundos, para aceder às definições.
- ▶ Seleccionar o parâmetro pretendido (602).
- ▶ Premir a tecla de codificação ("encoder"), para aceder ao ecrã "Gestão de controlos externos".

Gestão de controlos externos



- ▶ Carregar no botão, para seleccionar a saída de comando à distância RC pretendida (CH1, CH2, CH3, CH4). **CH1**
- ▶ Premir a tecla de codificação ("encoder"), para seleccionar o parâmetro pretendido (Mín.-Máx-parâmetro).
- ▶ Rodar a tecla de codificação ("encoder"), para regular o parâmetro pretendido (Mín.-Máx-parâmetro).
- ▶ Para guardar a alteração, premir o botão: .
- ▶ Carregar no botão, para confirmar a operação .

5.2.5 Calibração da resistência do circuito (set up 705)

Permite calibrar o gerador para a resistência atual do circuito de soldadura.



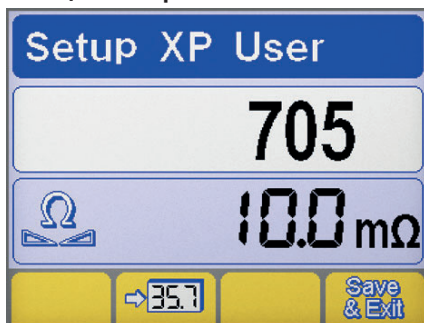

Seleção de parâmetro

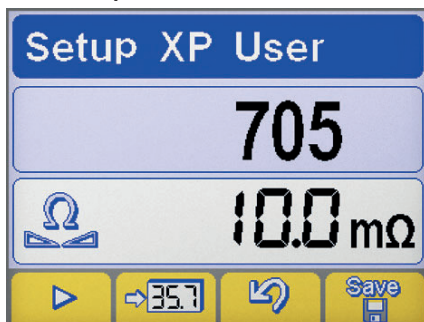

- ▶ Premir a tecla de codificação ("encoder") durante, pelo menos, 5 segundos, para aceder às definições.
- ▶ Seleccionar o parâmetro pretendido (705).
- ▶ Premir a tecla de codificação ("encoder"), para activar a regulação do parâmetro seleccionado.
- ▶ Ligar o gerador ao circuito de soldadura (banca ou peça).
- ▶ Tirar a tampa para aplicar a ponta adaptadora do bico do lança-chamas exposta. (MIG/MAG)

Calibração



- ▶ Colocar a extremidade do guia de fio em contacto eléctrico com a peça de trabalho. (MIG/MAG)
- ▶ Premir o botão  para começar o procedimento.
- ▶ Manter o contacto durante, pelo menos, um segundo.
- ▶ O valor exibido no visor será atualizado no final da calibração.
- ▶ Carregar no botão, para confirmar a operação .
- ▶ Carregar no botão, para confirmar a operação .
- ▶ Para guardar a alteração e sair da configuração, premir o botão: .

5.2.6 Limites de segurança (Set up 801)

Permite a definição dos limites de aviso e dos limites de segurança.

Permite o controlo do processo de soldadura, através da definição de limites de aviso e limites de segurança, aplicáveis aos principais parâmetros mensuráveis.

Permite o controlo preciso das várias fases de soldadura.



I_i Corrente de soldadura

V tensão de soldadura



Leitura do fluxo de gás



Velocidade de movimentação de robô



Leitura de corrente (motor 1)



Leitura de corrente (motor 2)



Medição do fluxo do líquido de refrigeração



Leitura de velocidade do fio



Leitura de temperatura do líquido de refrigeração

Seleção de parâmetro

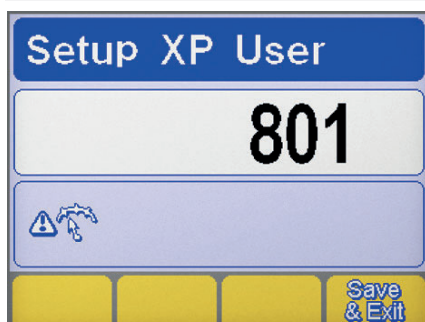

- ▶ Premir a tecla de codificação (“encoder”) durante, pelo menos, 5 segundos, para aceder às definições.
- ▶ Seleccionar o parâmetro pretendido (801).
- ▶ Premir a tecla de codificação (“encoder”), para aceder ao ecrã “Limites de segurança”.

Seleção do parâmetro

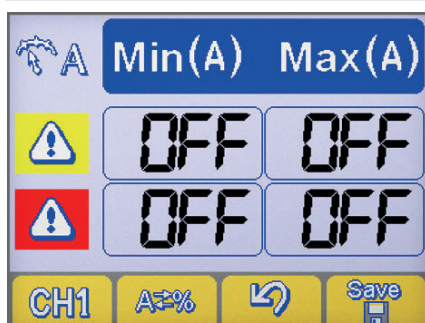

- ▶ Carregar no botão para seleccionar o parâmetro pretendido **CH1**.
- ▶ Carregar no botão para seleccionar o método de definição dos limites de segurança **A=%**.

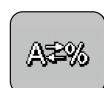

Configuração da máquina



Valor absoluto



Valor percentual

Definição dos limites de alerta

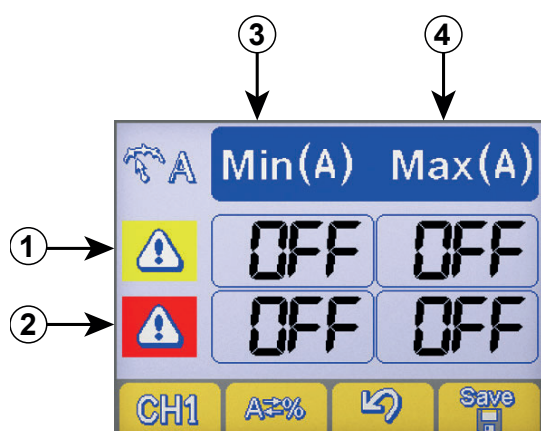

- ① Linha dos limites de aviso
- ② Linha dos limites de alarme
- ③ Coluna de níveis mínimos
- ④ Coluna de níveis máximos

- ▶ Premir a tecla de codificação (“encoder”), para seleccionar a caixa pretendida (a caixa seleccionada é apresentada com inversão de contraste).
- ▶ Rodar a tecla de codificação (“encoder”), para regular o nível do limite seleccionado.
- ▶ Para guardar a alteração, premir o botão:

PT



- Ultrapassar um dos limites de aviso faz surgir um sinal visual no painel de controlo.
- Ultrapassar um dos limites de alarme faz surgir um sinal visual no painel de controlo e provoca o bloqueio imediato das operações de soldadura.
- É possível definir filtros de soldadura iniciais e finais, para evitar sinais de erro na ignição e extinção do arco (consultar a secção “Definições” - Parâmetros 802-803-804).

6. MANUTENÇÃO



A instalação deve ser submetida a operações de manutenção de rotina, de acordo com as indicações do fabricante. Quando o equipamento está em funcionamento, todas as portas e tampas de acesso e de serviço deverão estar fechadas e trancadas. Os sistemas não devem ser submetidos a qualquer tipo de modificação. Evitar a acumulação de poeiras condutoras de electricidade perto das aletas de ventilação e sobre as mesmas.



As operações de manutenção deverão ser efectuadas exclusivamente por pessoal especializado. A reparação ou substituição de componentes do sistema que seja executada por pessoal não-autorizado implica a imediata anulação da garantia do produto. A eventual reparação ou substituição de componentes do sistema tem de ser executada exclusivamente por pessoal técnico qualificado.



Antes da qualquer operação de manutenção, desligar o equipamento da corrente eléctrica!

6.1 Efectuar periodicamente as seguintes operações

6.1.1 Anlegg



Limpar o interior do gerador com ar comprimido a baixa pressão e com escovas de cerdas suaves. Verificar as ligações eléctricas e todos os cabos de ligação.

6.1.2 Para a manutenção ou substituição de componentes da tocha, do porta-eléctrodos e/ou dos cabos de terra:



Verificar a temperatura dos componentes e assegurar-se de que não estão sobreaquecidos.



Utilizar sempre luvas conformes às normas de segurança.



Utilizar chaves inglesas e ferramentas adequadas.

6.2 Ansvar



Caso a referida manutenção não seja executada, todas as garantias serão anuladas, isentando o fabricante de toda e qualquer responsabilidade. O incumprimento destas instruções isentará o fabricante de toda e qualquer responsabilidade. Se tiver quaisquer dúvidas e/ou problemas, não hesite em contactar o centro de assistência técnica mais perto de si.

7. CÓDIGOS DE ALARME



ALARME

A intervenção de um alarme ou a superação de um limite de alerta crítico provoca um sinal visual no painel de comando e o bloqueio imediato das operações de soldadura.



ATENÇÃO

A intervenção de um alarme ou a superação de um limite de alerta crítico provoca um sinal visual no painel de comando e o bloqueio imediato das operações de soldadura.

Incluímos, a seguir, uma lista com todos os alarmes e limites de alerta inerentes ao sistema.

 E01	Sobretensão		 E02	Sobretensão	
 E03	Sobretensão		 E05	Sobrecorrente	
 E06	Sobrecorrente do módulo de potência (Boost)		 E07	Erro no sistema de alimentação do motor do puxador de fio	
 E08	Motor bloqueado		 E10	Sobrecorrente do módulo de potência (Inverter)	
 E11	Erro de configuração do sistema		 E12	Erro de comunicação (WF - DSP)	
 E13	Erro de comunicação		 E14	Programa inválido	
 E15	Programa inválido		 E16	Erro de comunicação (RI) (Automatização e robótico)	
 E17	Erro de comunicação (µP-DSP)		 E18	Programa inválido	
 E19	Erro de configuração do sistema		 E20	Memória defeituosa	
 E21	Perda de dados		 E22	Erro de comunicação (DSP)	
 E29	Medidas incompatíveis		 E30	Erro de comunicação (H.F.)	
 E32	Perda de dados		 E38	Subtensão	
 E39	Falha na alimentação do equipamento		 E40	Falha na alimentação do equipamento	
 E43	Falta de líquido refrigerante		 E48	Falta de fio (Automatização e robótico)	
 E49	Interruptor de emergência (Automatização e robótico)		 E50	Fio colado (Automatização e robótico)	
 E51	Definições não suportadas (Automatização e robótico)		 E52	Anticolisão (Automatização e robótico)	
 E53	Erro do fluxostato externo (Automatização e robótico)		 E54	Nível de corrente ultrapassado (Limite inferior)	

PT

E55	Nível de corrente ultrapassado (Limite superior)		E56	Nível de tensão ultrapassado (Limite inferior)	
E57	Nível de tensão ultrapassado (Limite superior)		E60	Limite de velocidade ultrapassado (Limite inferior)	
E61	Limite de velocidade ultrapassado (Limite superior)		E62	Nível de corrente ultrapassado (Limite inferior)	
E63	Nível de corrente ultrapassado (Limite superior)		E64	Nível de tensão ultrapassado (Limite inferior)	
E65	Nível de tensão ultrapassado (Limite superior)		E68	Limite de velocidade ultrapassado (Limite inferior)	
E69	Limite de velocidade ultrapassado (Limite superior)		E70	Limites de alerta definidos incompatíveis	
E71	Sobretensão do líquido refrigerante		E72	Sobrecorrente no motor push-pull	
E73	Limite de velocidade do fio ultrapassado (speed meter)		E74	Nível de corrente do motor 1 ultrapassado	
E75	Nível de corrente do motor 2 ultrapassado		E76	Nível de fluxo do líquido refrigerante ultrapassado	
E77	Nível de temperatura do líquido refrigerante		E78	Manutenção ativa (Automatização e robótica)	

8. RESOLUÇÃO DE PROBLEMAS

A instalação não é activada (LED verde apagado)

Causa

- » Tomada de alimentação sem tensão.
- » Ficha ou cabo de alimentação danificado.
- » Fusível geral queimado.
- » Interruptor de funcionamento danificado.
- » Ligação incorrecta ou defeituosa entre o dispositivo de alimentação do fio e o gerador.
- » Sistema electrónico danificado.

Solução

- » Verificar e reparar o sistema eléctrico, conforme necessário.
- » Recorrer a pessoal especializado.
- » Substituir o componente danificado.
- » Contactar o centro de assistência mais próximo para a reparação do sistema.
- » Substituir o componente danificado.
- » Substituir o componente danificado.
- » Contactar o centro de assistência mais próximo para a reparação do sistema.
- » Verifique se os vários componentes do sistema estão correctamente ligados.
- » Contactar o centro de assistência mais próximo para a reparação do sistema.

Não há potência na saída (a máquina não solda)

Causa

- » Botão de accionamento da tocha danificado.

Solução

- » Substituir o componente danificado.
- » Contactar o centro de assistência mais próximo para a reparação do sistema.

» Instalação em sobreaquecimento (alarme de temperatura - LED amarelo aceso).	» Aguardar que o sistema arrefeça, sem o desligar.
» Tampa lateral aberta ou interruptor da porta danificado.	» Por motivos de segurança operacional é necessário que, durante a soldadura, a tampa lateral esteja fechada. » Substituir o componente danificado. » Contactar o centro de assistência mais próximo para a reparação do sistema.
» Ligação à terra incorrecta.	» Executar correctamente a ligação de terra. » Consultar a secção “Instalação”.
» Tensão de rede fora dos limites (LED amarelo aceso).	» Colocar a tensão de rede dentro dos limites de alimentação do gerador. » Executar correctamente a ligação da instalação. » Consultar a secção “Ligações”.
» Sistema electrónico danificado.	» Contactar o centro de assistência mais próximo para a reparação do sistema.

Potência de saída incorrecta

Causa	Solução
» Selecção incorrecta do processo de soldadura ou comutador de selecção defeituoso.	» Seleccionar correctamente o processo de soldadura. » Substituir o componente danificado. » Contactar o centro de assistência mais próximo para a reparação do sistema.
» Definição incorrecta dos parâmetros ou funções do sistema.	» Efectuar a reposição aos valores originais e redefinir os parâmetros de soldadura.
» Potenciómetro/“encoder” para regulação da corrente de soldadura danificado.	» Substituir o componente danificado. » Contactar o centro de assistência mais próximo para a reparação do sistema.
» Tensão de rede fora dos limites.	» Executar correctamente a ligação da instalação. » Consultar a secção “Ligações”.
» Ausência de uma fase de entrada.	» Executar correctamente a ligação da instalação. » Consultar a secção “Ligações”.
» Sistema electrónico danificado.	» Contactar o centro de assistência mais próximo para a reparação do sistema.

Mecanismo de avanço do fio bloqueado

Causa	Solução
» Botão de accionamento da tocha danificado.	» Substituir o componente danificado. » Contactar o centro de assistência mais próximo para a reparação do sistema.
» Rolos incorrectos ou gastos.	» Substituir os rolos.
» Mecanismo de avanço de fio danificado.	» Substituir o componente danificado. » Contactar o centro de assistência mais próximo para a reparação do sistema.
» Bainha da tocha danificada.	» Substituir o componente danificado. » Contactar o centro de assistência mais próximo para a reparação do sistema.
» Mecanismo de avanço de fio não alimentado.	» Verificar a ligação à fonte de alimentação. » Consultar a secção “Ligações”. » Contactar o centro de assistência mais próximo para a reparação do sistema.
» Enrolamento irregular na bobina.	» Restabelecer as condições normais de enrolamento da bobina ou substituí-la.
» Bico da tocha fundido (fio colado)	» Substituir o componente danificado.

Avanço do fio irregular

Causa	Solução
» Botão de accionamento da tocha danificado.	» Substituir o componente danificado. » Contactar o centro de assistência mais próximo para a reparação do sistema.

» Rolos incorrectos ou gastos.	» Substituir os rolos.
» Mecanismo de avanço de fio danificado.	» Substituir o componente danificado.
	» Contactar o centro de assistência mais próximo para a reparação do sistema.
» Bainha da tocha danificada.	» Substituir o componente danificado.
	» Contactar o centro de assistência mais próximo para a reparação do sistema.
» Engrenagem do carretel ou dispositivos de bloqueio dos rolos mal regulados.	» Desapertar a engrenagem.
	» Aumentar a pressão nos rolos.

Instabilidade do arco

Causa	Solução
» Gás de protecção insuficiente.	» Regular correctamente o fluxo do gás.
	» Verificar se o difusor e o bico de gás da tocha se encontram em boas condições.
» Presença de humidade no gás de soldadura.	» Utilizar sempre produtos e materiais de qualidade.
	» Manter sempre o sistema de alimentação do gás em perfeitas condições.
» Parâmetros de soldadura incorrectos.	» Verificar cuidadosamente a instalação de soldadura.
	» Contactar o centro de assistência mais próximo para a reparação do sistema.

projecção excessiva de salpicos

Causa	Solução
» Comprimento incorrecto do arco.	» Reduzir a distância entre o eléctrodo e a peça.
	» Reduzir a tensão de soldadura.
» Parâmetros de soldadura incorrectos.	» Reduzir a tensão de soldadura.
» Gás de protecção insuficiente.	» Regular correctamente o fluxo do gás.
	» Verificar se o difusor e o bico de gás da tocha se encontram em boas condições.
» Dinâmica do arco incorrecta.	» Aumentar o valor indutivo do circuito equivalente.
	» Utilizar uma maior ligação indutiva.
» Modo de execução da soldadura incorrecto.	» Reduzir o ângulo da tocha.

Penetração insuficiente

Causa	Solução
» Modo de execução da soldadura incorrecto.	» Reduzir a velocidade de avanço em soldadura.
» Parâmetros de soldadura incorrectos.	» Aumentar a corrente de soldadura.
» Eléctrodo incorrecto.	» Utilizar um eléctrodo com diâmetro inferior.
» Preparação incorrecta dos bordos.	» Aumentar a abertura do chanfro.
» Ligação à terra incorrecta.	» Executar correctamente a ligação de terra.
	» Consultar a secção "Instalação".
» Peças a soldar demasiado grandes.	» Aumentar a corrente de soldadura.

Incrustações de escórias

Causa	Solução
» Remoção incompleta da escória.	» Limpar as peças devidamente, antes de executar a soldadura.
» Eléctrodo com diâmetro excessivo.	» Utilizar um eléctrodo com diâmetro inferior.
» Preparação incorrecta dos bordos.	» Aumentar a abertura do chanfro.
» Modo de execução da soldadura incorrecto.	» Reduzir a distância entre o eléctrodo e a peça.
	» Avançar regularmente durante todas as fases da soldadura.

Inclusões de tungsténio

Causa	Solução
» Parâmetros de soldadura incorrectos.	» Reduzir a tensão de soldadura.
	» Utilizar um eléctrodo com diâmetro superior.

» Eléctrodo incorrecto.

» Utilizar sempre produtos e materiais de qualidade.

» Afiar cuidadosamente o eléctrodo.

» Modo de execução da soldadura incorrecto.

» Evitar o contacto entre o eléctrodo e o banho de fusão.

Poros

Causa

» Gás de protecção insuficiente.

Solução

» Regular correctamente o fluxo do gás.

» Verificar se o difusor e o bico de gás da tocha se encontram em boas condições.

Colagem

Causa

» Comprimento incorrecto do arco.

Solução

» Aumentar a distância entre o eléctrodo e a peça

» Aumentar a tensão de soldadura.

» Parâmetros de soldadura incorrectos.

» Aumentar a corrente de soldadura.

» Aumentar a tensão de soldadura.

» Modo de execução da soldadura incorrecto.

» Aumentar o ângulo de inclinação da tocha.

» Peças a soldar demasiado grandes.

» Aumentar a corrente de soldadura.

» Dinâmica do arco incorrecta.

» Aumentar o valor indutivo do circuito equivalente.

» Utilizar uma maior ligação indutiva.

Bordos queimados

Causa

» Parâmetros de soldadura incorrectos.

Solução

» Reduzir a tensão de soldadura.

» Utilizar um eléctrodo com diâmetro inferior.

» Comprimento incorrecto do arco.

» Reduzir a distância entre o eléctrodo e a peça.

» Reduzir a tensão de soldadura.

» Modo de execução da soldadura incorrecto.

» Reduzir a velocidade de oscilação lateral no enchimento.

» Reduzir a velocidade de avanço em soldadura.

» Gás de protecção insuficiente.

» Utilizar gases adequados aos materiais a soldar.

Oxidações

Causa

» Gás de protecção insuficiente.

Solução

» Regular correctamente o fluxo do gás.

» Verificar se o difusor e o bico de gás da tocha se encontram em boas condições.

Porosità

Causa

» Presença de gordura, tinta, ferrugem ou sujidade nas peças a soldar.

Solução

» Limpar as peças devidamente, antes de executar a soldadura.

» Presença de gordura, tinta, ferrugem ou sujidade no material de adição.

» Utilizar sempre produtos e materiais de qualidade.

» Manter sempre o material de adição em perfeitas condições.

» Presença de humidade no material de adição.

» Utilizar sempre produtos e materiais de qualidade.

» Manter sempre o material de adição em perfeitas condições.

» Comprimento incorrecto do arco.

» Reduzir a distância entre o eléctrodo e a peça.

» Reduzir a tensão de soldadura.

» Presença de humidade no gás de soldadura.

» Utilizar sempre produtos e materiais de qualidade.

» Manter sempre o sistema de alimentação do gás em perfeitas condições.

» Gás de protecção insuficiente.

» Regular correctamente o fluxo do gás.

» Verificar se o difusor e o bico de gás da tocha se encontram em boas condições.

» Solidificação demasiado rápida do banho de fusão.

» Reduzir a velocidade de avanço em soldadura.

» Executar um pré-aquecimento das peças a soldar.

» Aumentar a corrente de soldadura.

PT

Fissuras a quente

Causa	Solução
» Parâmetros de soldadura incorrectos.	» Reduzir a tensão de soldadura. » Utilizar um eléctrodo com diâmetro inferior.
» Presença de gordura, tinta, ferrugem ou sujidade nas peças a soldar.	» Limpar as peças devidamente, antes de executar a soldadura.
» Presença de gordura, tinta, ferrugem ou sujidade no material de adição.	» Utilizar sempre produtos e materiais de qualidade. » Manter sempre o material de adição em perfeitas condições.
» Modo de execução da soldadura incorrecto.	» Executar a sequência correcta de operações para o tipo de junta a soldar.
» Peças a soldar com características diferentes.	» Executar um amanteigamento antes de executar a soldadura.

Fissuras a frio

Causa	Solução
» Presença de humidade no material de adição.	» Utilizar sempre produtos e materiais de qualidade. » Manter sempre o material de adição em perfeitas condições.
» Geometria particular da junta a soldar.	» Executar um pré-aquecimento das peças a soldar. » Executar um pós-aquecimento. » Executar a sequência correcta de operações para o tipo de junta a soldar.

9. NOÇÕES TEÓRICAS SOBRE A SOLDADURA

9.1 Soldadura manual por arco voltaico (MMA)

Preparação dos bordos

Para obter boas soldaduras é sempre recomendável trabalhar peças limpas, não oxidadas, sem ferrugem nem outros agentes contaminadores.

Escolha do eléctrodo

O diâmetro do eléctrodo a utilizar depende da espessura do material, da posição, do tipo de junção e do tipo de preparação a que a peça a soldar tenha sido sujeita. Eléctrodos com maior diâmetro exigem, como é lógico, correntes muito elevadas, com um consequente fornecimento de calor muito intenso durante a soldadura.

Tipo de revestimento	Propriedades	Utilização
Rutilo	Facil. de utilização	Todas as posições
Ácido	Alta velocid. de fusão	Plano
Básico	Caract. Mecânicas	Todas as posições

Escolha da corrente de soldadura

Os valores da corrente de soldadura, relativamente ao tipo de eléctrodo utilizado, são especificados pelo fabricante na embalagem do eléctrodo.

Acender e manter o arco

O arco eléctrico é produzido por fricção da ponta do eléctrodo na peça de trabalho ligada ao cabo de terra e, logo que o arco estiver aceso, afastando rapidamente a vareta para a distância normal de soldadura.

Normalmente, para melhorar a ignição do arco, é fornecida uma corrente inicial superior, de modo a provocar um aquecimento súbito da extremidade do eléctrodo, para melhorar o estabelecimento do arco ("Hot Start"). Uma vez o arco aceso, inicia-se a fusão da parte central do eléctrodo que se deposita em forma de gotas no banho de fusão da peça a soldar. O revestimento externo do eléctrodo é consumido, fornecendo o gás de protecção para a soldadura, assegurando assim que a mesma será de boa qualidade. Para evitar que as gotas de material fundido apaguem o arco, por curto-circuito, e colem o eléctrodo ao banho de fusão, devido a uma aproximação acidental entre ambos, é disponibilizado um aumento temporário da corrente de soldadura, de forma a neutralizar o curto-circuito (Arc Force). Caso o eléctrodo permaneça colado à peça a soldar, a corrente de curto-circuito deve ser reduzida para o valor mínimo ("antisticking").

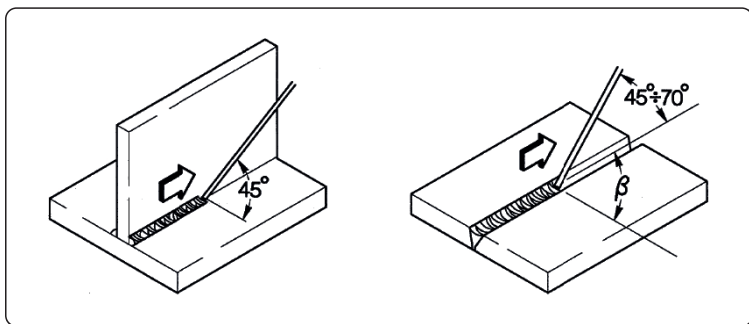

Execução da soldadura

L'angolo di inclinazione dell'elettrodo varia a seconda del numero delle passate, il movimento dell'elettrodo viene eseguito normalmente con oscillazioni e fermate ai lati del cordone in modo da evitare un accumulo eccessivo di materiale d'apporto al centro.

Remoção da escória

A soldadura por eléctrodos revestidos obriga à remoção da escória após cada passagem. A escória é removida com um pequeno martelo ou com uma escova, se estiver fria.

9.2 Soldadura TIG (arco contínuo)

Descrição

O processo de soldadura TIG ("Tungsten Inert Gas" - Tungsténio Gás Inerte) baseia-se na presença de um arco eléctrico aceso entre um eléctrodo não consumível (tungsténio puro ou em liga, com uma temperatura de fusão de cerca de 3370° C) e a peça de trabalho; uma atmosfera de gás inerte (árgon) assegura a protecção do banho de fusão. O eléctrodo nunca deve tocar na peça de trabalho, para evitar o perigo representado pela entrada de tungsténio na junta; por esse motivo, a fonte de alimentação de soldadura dispõe, normalmente, de um dispositivo de início do arco que gera uma descarga de alta frequência e alta tensão, entre a extremidade do eléctrodo e a peça de trabalho. Assim, devido à faísca eléctrica que ioniza a atmosfera gasosa, o arco de soldadura começa sem que haja contacto entre o eléctrodo e a peça de trabalho. Existe ainda outro tipo de arranque com introduções reduzidas de tungsténio: o arranque em "lift" (elevação) que não requer alta frequência mas apenas um curto-circuito inicial, a baixa corrente, entre o eléctrodo e a peça a soldar; o arco inicia-se quando o eléctrodo sobe e a corrente aumenta até atingir o valor de soldadura previamente estabelecido. Para melhorar a qualidade da parte final do cordão de soldadura é importante verificar com precisão a descida da corrente de soldadura e é necessário que o gás flua no banho de fusão por alguns segundos, após a finalização do arco. Em muitas condições operativas é útil poder dispor de 2 correntes de soldadura predefinidas e poder passar facilmente de uma para outra (BILEVEL).

Polaridade de soldadura

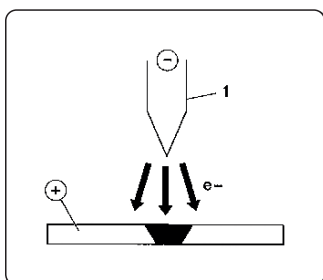

D.C.S.P. (Direct Current Straight Polarity - Polaridade Directa de Corrente Contínua)

Esta é a polaridade mais utilizada e assegura um desgaste limitado do eléctrodo (1), uma vez que 70 % do calor se concentra no ânodo (ou seja, na peça).

Com altas velocidades de avanço e baixo fornecimento de calor obtêm-se banhos de solda estreitos e fundos.

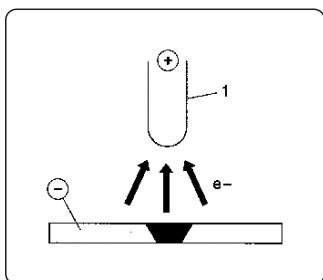

D.C.R.P. (Direct Current Reverse Polarity - Polaridade Inversa de Corrente Contínua)

A polaridade inversa é utilizada na soldadura de ligas cobertas com uma camada de óxido refractário, com uma temperatura de fusão superior à dos metais.

Não se podem utilizar correntes elevadas, uma vez que estas provocariam um desgaste excessivo do eléctrodo.

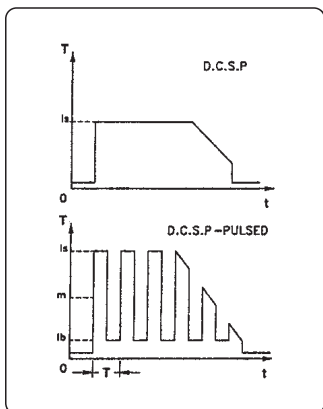

D.C.S.P.-Pulsed (Direct Current Straight Polarity Pulsed - Pulsação de Polaridade Directa de Corrente Contínua)

A adopção de uma corrente contínua pulsada permite controlar melhor o banho de fusão, em condições operacionais específicas.

O banho de fusão é formado pelos impulsos de pico (Ip), enquanto a corrente de base (Ib) mantém o arco aceso; isto facilita a soldadura de pequenas espessuras, com menos deformações, melhor factor de forma e conseqüente menor perigo de formação de fendas a quente e de introduções gasosas.

Com o aumento da frequência (média frequência) obtêm-se um arco mais estreito, mais concentrado e mais estável, o que permite uma melhor qualidade de soldadura de espessuras finas.

PT

Soldadura TIG de aço

O procedimento TIG é muito eficaz na soldadura dos aços, quer sejam de carbono ou resultem de ligas, para a primeira passagem sobre os tubos e nas soldaduras que devam apresentar bom aspecto estético. É necessária polaridade directa (D.C.S.P.).

Preparação dos bordos

Torna-se necessário efectuar uma limpeza cuidadosa bem como uma correcta preparação dos bordos.

Escolha e preparação do eléctrodo

Aconselhamos o uso de eléctrodos de tungsténio toriado (2% de tório-coloração vermelha) ou, em alternativa, eléctrodos de cério ou lantânio com os seguintes diâmetro:

Ø eléctrodo	Limites de corrente
1.0 mm	15÷75 A
1.6 mm	60÷150 A
2.4 mm	130÷240 A

O eléctrodo deverá ser afiado conforme indica a figura.

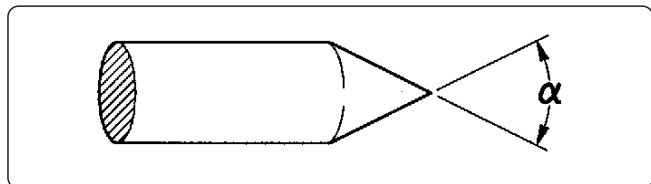

α°	Limites de corrente
30	0÷30 A
60÷90	30÷120 A
90÷120	120÷250 A

Material de adição

As barras de adição deverão ter características mecânicas semelhantes às do material base.

Não utilizar tiras retiradas do material base, uma vez que estas podem conter impurezas resultantes da manipulação, que poderão afectar negativamente a qualidade da soldadura.

Gás de protecção

Normalmente, é utilizado argon puro (99,99 %).

Corrente de soldadura	Ø eléctrodo	Bico de gás n°	Bico de gás	Fluxo de argônio
30 A	0÷30 mm	4/5	6/8.0 mm	5-6 l/min
60÷90 A	30÷120 mm	4/5/6	6.5/8.0/9.5 mm	6-7 l/min
90÷120 A	120÷250 mm	6/7	9.5/11.0 mm	7-8 l/min

Soldadura TIG de cobre

Uma vez que a soldadura TIG é um processo que se caracteriza por uma elevada concentração de calor, é especialmente indicada para materiais de soldadura com condutividade térmica elevada, tais como o cobre.

Para a soldadura TIG do cobre siga as mesmas indicações da soldadura TIG dos aços ou consulte textos específicos.

9.3 Soldadura com fio contínuo (MIG/MAG)

Introdução

Um sistema MIG é formado por uma fonte de alimentação em corrente contínua, um mecanismo de avanço do fio, uma bobina de fio, uma tocha e gás.

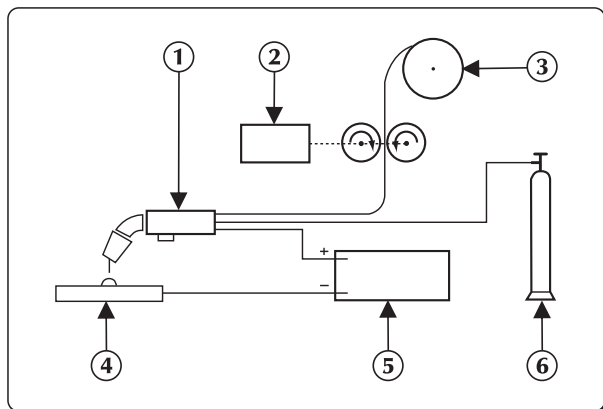

Equipamento de soldadura manual

A corrente é transferida para o arco eléctrico através do eléctrodo fusível (fio ligado ao pólo positivo);

Neste procedimento, o metal fundido é transferido, através do arco eléctrico, para a peça a ser soldada.

A alimentação automática do eléctrodo de material de adição contínuo (fio) é necessária, para reintegrar o fio fundido durante a soldadura.

Métodos de procedimento

Na soldadura MIG, há dois mecanismos principais de transferência de metal, que podem ser classificados consoante o modo como o metal é transferido do eléctrodo para a peça de trabalho.

Um primeiro método, denominado “TRANSFERÊNCIA POR CURTO-CIRCUITO (SHORT-ARC)”, produz um banho de fusão de pequenas dimensões e solidificação rápida, em que o metal é transferido do eléctrodo para a peça de trabalho durante um curto período, quando aquele está em contacto com o banho de fusão. Neste período, o eléctrodo toca directamente com o banho de fusão, produzindo um curto-circuito que faz fundir o fio, interrompendo-o. Em seguida, o arco eléctrico acende-se novamente e o ciclo repete-se.

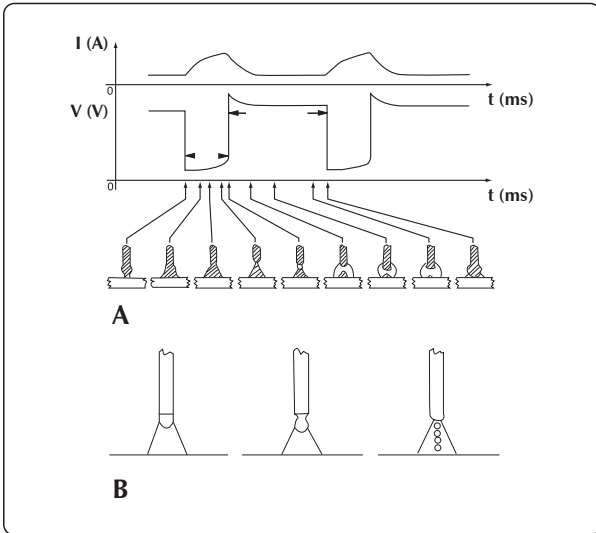

Ciclo “SHORT” e soldadura “SPRAY ARC”

Num outro método, denominado “TRANSFERÊNCIA SPRAY-ARC”, a transferência de metal ocorre em pequenas gotas que se formam e libertam da extremidade do fio, sendo transferidas para o banho de fusão através do arco.

Parâmetros de soldadura

A visibilidade do arco eléctrico reduz a necessidade de uma observância rígida das tabelas de regulação por parte do operador, que tem a possibilidade de controlar directamente o banho de fusão.

- A tensão influencia directamente o aspecto do cordão, mas as dimensões da superfície soldada podem ser modificadas em função das exigências, deslocando a tocha manualmente, para obter depósitos variáveis com tensão contínua.
- A velocidade de avanço do fio está relacionada com a corrente de soldadura.

På de to neste figurene vises forholdene mellom de ulike sveiseparameterene.







Diagrama para a selecção óptima da melhor característica de trabalho.

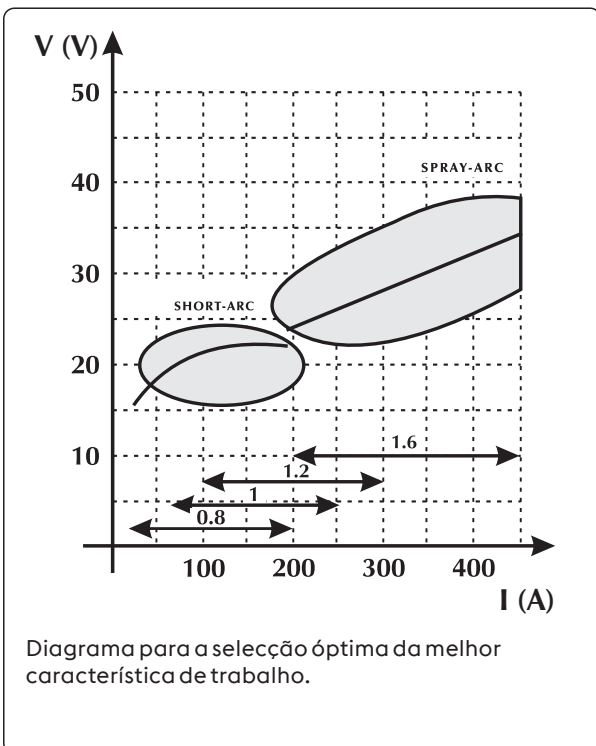
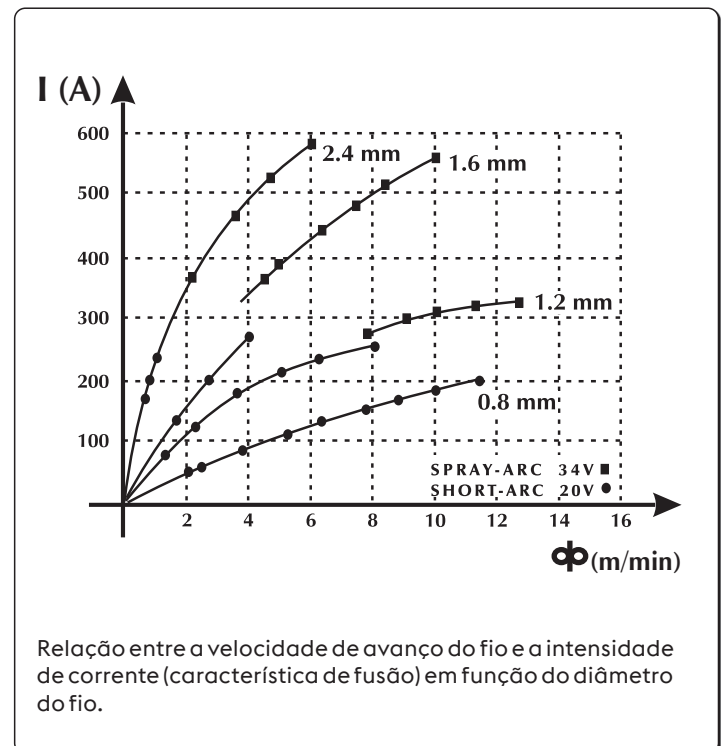

Relação entre a velocidade de avanço do fio e a intensidade de corrente (característica de fusão) em função do diâmetro do fio.

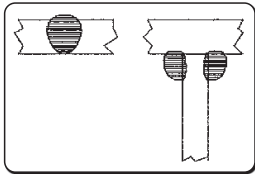
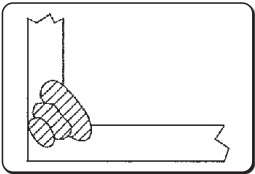
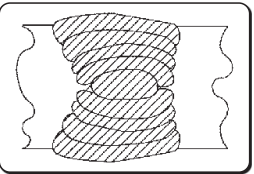
PT

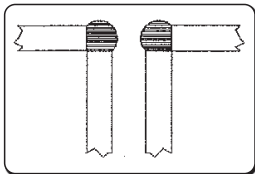
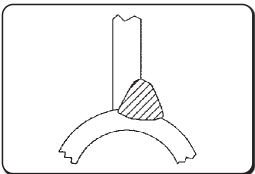
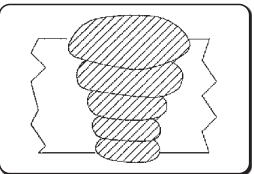
Tabela de orientação para a escolha dos parâmetros de soldadura, relativamente às aplicações mais comuns e aos fios mais utilizados.

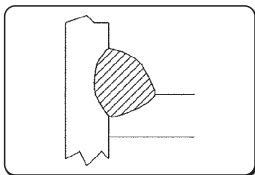
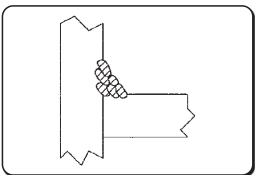
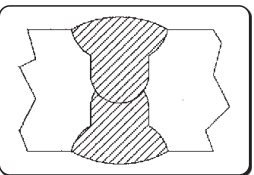
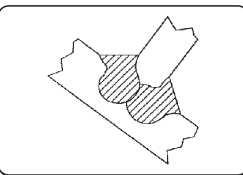
Tensão do arco	Ø 0,8 mm	Ø 1,0-1,2 mm	Ø 1,6 mm	Ø 2,4 mm
16V - 22V SHORT - ARC				
	60 - 160 A	100 - 175 A	120 - 180 A	150 - 200 A
	Baixa penetração para pequenas espessuras	Bom controlo da penetração e da fusão	Boa fusão horizontal e vertical	Não utilizado
24V - 28V SEMI SHORT-ARC (Zona de transição)				
	150 - 250 A	200 - 300 A	250 - 350 A	300 - 400 A
	Soldadura automática em ângulo	Soldadura automática de alta tensão	Soldadura automática descendente	Não utilizado
30V - 45V "SPRAY - ARC"				
	150 - 250 A	200 - 350 A	300 - 500 A	500 - 750 A
	Baixa penetração com regulação a 200 A	Soldadura automática com passagens múltiplas	Boa penetração descendente	Boa penetração com alto depósito em grandes espessuras

Gases utilizáveis

A soldadura MIG-MAG caracteriza-se principalmente pelo tipo de gás utilizado: inerte para a soldadura MIG ("Metal Inert Gas"), activo para a soldadura MAG ("Metal Active Gas").

- Anidrido carbónico (CO₂)

Utilizando CO₂ como gás de protecção obtêm-se elevadas penetrações, elevada velocidade de avanço e boas propriedades mecânicas, juntamente com baixos custos operacionais. Não obstante, a utilização deste gás origina problemas consideráveis na composição química final das soldagens, dado existir uma elevada perda de elementos facilmente oxidáveis, simultaneamente com um enriquecimento de carbono do banho de fusão. A soldadura com CO₂ puro implica também outro tipo de problemas, como excesso de salpicos e formação de porosidade de monóxido de carbono.

- Árgon

Este gás inerte é utilizado puro na soldadura de ligas leves e, com a adição de oxigénio e CO₂, numa percentagem de 2%, na soldadura de aços inoxidáveis de cromo-níquel; isto contribui para melhorar a estabilidade do arco e a formação do cordão de soldadura.

- Hélio

Este gás é utilizado como alternativa ao árgon, permitindo maiores penetrações (em grandes espessuras) e maiores velocidades de avanço.

- Mistura Árgon - Hélio

Proporciona um arco mais estável em relação ao hélio puro e uma maior penetração e velocidade em relação ao árgon.

- Mistura Árgon - CO₂ - e Árgon - CO₂ - Oxigénio

Estas misturas são utilizadas na soldadura de materiais ferrosos, sobretudo em condições de SHORT-ARC, pois melhoram o fornecimento de calor específico. Isto não exclui o uso em SPRAY-ARC.

Normalmente a mistura contém uma percentagem de CO₂, compreendida entre 8%-20%, e de O₂, de aproximadamente 5%.

Consulte o manual de Instruções do sistema.

10. CARACTERÍSTICAS TÉCNICAS

Características elétricas			U.M.
Tensão de alimentação U1 (50/60 Hz)	3x230 (±15%)	3x400 (±15%)	Vac
Zmax (@PCC)*	62	62	mΩ
Fusível geral atrasado	30	20	A
Bus de comunicação	DIGITALE	DIGITALE	
Potência máxima de entrada	13.3	13.0	kVA
Potência máxima de entrada	12.8	12.4	kW
Potência absorvida em estado de inatividade	71	71	W
Factor de potência (PF)	0.96	0.95	
Eficiência (μ)	85	85	%
Cos φ	0.99	0.99	
Corrente máxima de entrada I1max	32.9	18.8	A
Corrente efectiva I1eff	20.8	13.3	A
Gama de regulação (MMA)	3-320	3-320	A
Tensão em vazio Uo	75	75	Vdc

*Este equipamento cumpre a norma EN / IEC 61000-3-11.

*Este equipamento está em conformidade com a norma EN / IEC 61000-3-12 se a impedância da energia eléctrica máxima permitida no ponto de ligação à rede pública (ponto de acoplamento comum à rede pública (PAC)) for inferior ou igual ao valor "Zmax" fixado. Se estiver ligado a uma rede pública de baixa tensão, compete ao instalador ou utilizador do equipamento garantir a ligação do equipamento, consultando o fornecedor da rede de distribuição, se necessário.

Factor de utilização	3x230V	3x400V	U.M.
Factor de utilização MMA (40°C)			
(X=35%)	320	-	A
(X=50%)	-	320	A
(X=60%)	270	300	A
(X=100%)	230	250	A
Factor de utilização MMA (25°C)			
(X=60%)	320	320	A
(X=100%)	270	270	A
Factor de utilização TIG (40°C)			
(X=45%)	320	-	A
(X=60%)	300	320	A
(X=100%)	250	270	A
Factor de utilização TIG (25°C)			
(X=70%)	320	320	A
(X=100%)	270	270	A
Factor de utilização MIG/MAG (40°C)			
(X=35%)	320	-	A
(X=50%)	-	320	A
(X=60%)	280	310	A
(X=100%)	230	250	A
Factor de utilização MIG/MAG (25°C)			
(X=60%)	320	-	A
(X=70%)	-	320	A
(X=100%)	270	270	A

Características físicas			U.M.
Grau de protecção IP	IP23S		
Classe de isolamento	H		
Dimensões (lxwxh)	620x240x460		mm
Peso	26.7		Kg
Normas de construção	EN IEC 60974-1/A1:2019 EN IEC 60974-3:2019 EN 60974-10/A1:2015		
Secção cabo de alimentação.	4x4		mm ²
Comprimento do cabo de alimentação	5		m

11. PLACA DE DADOS

VOESTALPINE BÖHLER WELDING SELCO S.R.L. Via Palladio, 19 - ONARA (PADOVA) - ITALY			
URANOS NX 3200 PME		N°	
EN IEC 60974-1/A1:2019 60974-10/A1:2015 Class A			
U ₀ 75V	3A/20.0V - 320A (320A)/32.8V (32.8V)		
	X (40°C)	50% (35%)	60%
U ₀ 75V	I ₂	320A (320A)	300A (270A)
	U ₂	32.8V (32.8V)	32.0V (30.8V)
U ₀ 75V	3A/10.0V - 320A (320A)/22.8V (22.8V)		
	X (40°C)	(45%)	60%
U ₀ 75V	I ₂	(320A)	320A (300A)
	U ₂	(22.8V)	22.8V (22.0V)
U ₀ 75V	3A/14.0V - 320A (320A)/30.0V (30.0V)		
	X (40°C)	50% (35%)	60%
U ₀ 75V	I ₂	320A (320A)	310A (280A)
	U ₂	30.0V (30.0V)	29.5V (28.5V)
U ₁ 400V(230V)	I _{max} 18.8A(32.9A)	I _{eff} 13.3A(20.8A)	
IP 23 S	UKCA CE EAC MADE IN ITALY		

12. SIGNIFICADO DA PLACA DE DADOS

1		2			
3		4			
5		6			
7	9	23			
		11			
8	10	12	15	16	17
		13	15A	16A	17A
8	10	14	15B	16B	17B
		14	15B	16B	17B
7	9	11			
		12	15	16	17
8	10	13	15A	16A	17A
		14	15B	16B	17B
18	19	20	21		
22	UKCA CE EAC MADE IN ITALY				

- 1 Marca de fabrico
- 2 Nome e morada do fabricante
- 3 Modelo de equipamento
- 4 N.º de série
 XXXXXXXXXXXX Ano de fabrico
- 5 Símbolo do tipo de máquina de soldar
- 6 Referência às normas de fabrico
- 7 Símbolo do processo de soldadura
- 8 Símbolo para máquinas de soldar adequadas para trabalhar em ambiente com risco acrescido de choque elétrico
- 9 Símbolo da corrente de soldadura
- 10 Tensão nominal em vazio
- 11 Gama de corrente nominal máxima e mínima de soldadura e correspondente tensão de carga convencional
- 12 Símbolo do ciclo de intermitência
- 13 Símbolo de corrente nominal de soldadura
- 14 Símbolo de tensão nominal de soldadura
- 15 Valores do ciclo de intermitência
- 16 Valores do ciclo de intermitência
- 17 Valores do ciclo de intermitência
- 15A Valores da corrente nominal de soldadura
- 16A Valores da corrente nominal de soldadura
- 17A Valores da corrente nominal de soldadura
- 15B Valores da tensão convencional de carga
- 16B Valores da tensão convencional de carga
- 17B Valores da tensão convencional de carga
- 18 Símbolo para a alimentação
- 19 Tensão nominal de alimentação
- 20 Corrente nominal máxima de alimentação
- 21 Corrente eficaz máxima de alimentação
- 22 Grau de proteção
- 23 Tensão nominal de pico

CE Declaração de conformidade UE
 EAC Declaração de conformidade EAC
 UKCA Declaração de conformidade UKCA

EU-CONFORMITEITSVERKLARING

De bouwer

voestalpine Böhler Welding Selco S.r.l. - Via Palladio, 19 - 35019 Onara di Tombolo (PD) - ITALY
Tel. +39 049 9413/111 - Fax +39 049 9413/311 - www.voestalpine.com/welding

verklaart onder eigen verantwoordelijkheid dat het volgende product:

URANOS NX 3200 PME	55.03.066
	55.03.070

conform is met de normen EU:

2014/35/EU **LOW VOLTAGE DIRECTIVE**
2014/30/EU **EMC DIRECTIVE**
2011/65/EU **RoHS DIRECTIVE**

en dat de volgende geharmoniseerde normen zijn toegepast:

EN IEC 60974-1/A1:2019	WELDING POWER SOURCE
EN 60974-10/A1:2015	ELECTROMAGNETIC COMPATIBILITY REQUIREMENTS

De documentatie waaruit blijkt dat aan de richtlijnen wordt voldaan, wordt ter inzage gehouden bij de bovengenoemde fabrikant.

Iedere ingreep of modificatie die niet vooraf door voestalpine Böhler Welding Selco S.r.l. is goedgekeurd maakt dit certificaat ongeldig.

Onara di Tombolo, 15/10/2021

voestalpine Böhler Welding Selco s.r.l.

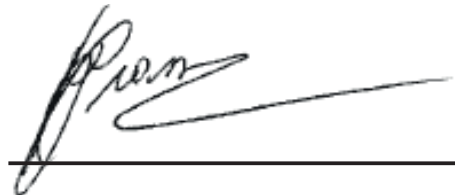

Lino Frasson

INHOUDSOPGAVE

1. WAARSCHUWING.....	283
1.1 Gebruiksomgeving.....	283
1.2 Bescherming voor de lasser en anderen.....	283
1.3 Bescherming tegen rook en gassen.....	284
1.4 Brand en explosie preventie.....	284
1.5 Voorzorgmaatregelen voor het gebruik van gasflessen.....	285
1.6 Beveiliging tegen elektrische schokken.....	285
1.7 Elektromagnetische velden en storingen.....	285
1.8 IP Beveiligingsgraad.....	286
1.9 Verwijdering.....	286
2. HET INSTALLEREN.....	287
2.1 Procedure voor het laden, vervoeren en lossen.....	287
2.2 Plaatsen van de installatie.....	287
2.3 Aansluiting.....	287
2.4 Installeren.....	288
3. PRESENTATIE VAN DE INSTALLATIE.....	290
3.1 Achter paneel.....	290
3.2 Paneel met contactpunten.....	290
3.3 Bedieningspaneel vooraan.....	290
3.4 Bedieningspaneel vooraan.....	291
4. GEBRUIK VAN APPARATUUR.....	292
4.1 Start scherm.....	292
4.2 Test scherm.....	292
4.3 Hoofd scherm.....	293
4.4 Hoofdscherm MMA-proces.....	293
5. SETUP.....	300
5.1 Set up en instelling van de parameters.....	300
5.2 Specifieke gebruiksprocedures van de parameters.....	309
6. ONDERHOUD.....	314
6.1 Controleer de stroombron regelmatig als volgt.....	314
6.2 Odpovědnost.....	314
7. ALARM CODES.....	314
8. MEEST VOORKOMENDE VRAGEN EN OPLOSSINGEN.....	316
9. ALGEMENE INFORMATIE OVER LASSEN.....	320
9.1 Handleiding lassen met beklede elektroden (MMA).....	320
9.2 TIG-Lassen met ononderbroken vlamboog.....	320
9.3 Lassen met constante draadtoevoer (MIG/MAG).....	322
10. TECHNISCHE KENMERKEN.....	325
11. TECHNISCHE GEGEVENS.....	326
12. BETEKENIS GEGEVENSPLAATJE.....	326
13. SCHEMA.....	557
14. VERBINDINGEN.....	559
15. LIJST VAN RESERVE ONDERDELEN.....	560

SYMBOLLEN



Ernstig gevaar op zware verwondingen en waarbij onvoorzichtig gedrag zwaar letsel kan veroorzaken.



Belangrijke aanwijzingen die moeten opgevolgd worden om lichte persoonlijke letsels en beschadigingen aan voorwerpen te vermijden.



De opmerkingen die na dit symbool komen zijn van technische aard en ergemakkelijken de bewerkingen.

1. WAARSCHUWING



Voor het gebruik van de machine dient u zich ervan te overtuigen dat u de handleiding goed heeft gelezen en begrepen.

Breng geen veranderingen aan en voer geen onderhoudswerkzaamheden uit die niet in deze handleiding vermeld staan. De fabrikant kan niet verantwoordelijk worden gehouden voor lichamelijke schade of schade aan eigendommen die zijn veroorzaakt door verkeerd gebruik van de machine of het onjuist interpreteren van de handleiding.

Säilytä käyttöohjeet aina laitteen käyttöpaikassa. Noudata käyttöohjeiden lisäksi voimassa olevia paikallisia tapaturmantorjuntaa ja ympäristön suojelua koskevia yleisiä määräyksiä ja sääntöjä.



Kaikkien laitteen käyttöönottoon, käyttöön, huoltoon ja korjaukseen osallistuvien henkilöiden tulee:

- omata asianmukainen pätevyys
- omata hitsauksessa tarvittavat taidot
- lukea nämä käyttöohjeet kokonaan ja noudattaa niitä tarkasti

In geval van twijfel of problemen bij het gebruik, zelfs als het niet staat vermeldt, raadpleeg uw leverancier.

1.1 Gebruiksomgeving



Iedere machine mag alleen worden gebruikt voor de werkzaamheden waarvoor hij is ontworpen, op de manier zoals is voorschreven op de gegevensplaat en/of deze handleiding, in overeenstemming met de nationale en internationale veiligheidsvoorschriften. Oneigenlijk gebruik zal worden gezien als absoluut ongepast en gevaarlijk en in een dergelijk geval zal de fabrikant iedere verantwoordelijkheid afwijzen.



Deze apparatuur dient uitsluitend voor professionele doeleinde te worden gebruikt in een industriële omgeving. De fabrikant kan niet aansprakelijk worden gesteld voor schade veroorzaakt door gebruik van de apparatuur in een huishoudelijke omgeving.



De omgevingstemperatuur voor gebruik van de machine moet liggen tussen -10° C en +40° C (Tussen +14°F en +104°F).

Voor transport en opslag moet de temperatuur liggen tussen -25°C en +55°C (tussen -13°F en +131°F).

De machine moet worden gebruikt in een stofvrije omgeving zonder zuren, gas of andere corrosieve stoffen.

De vochtigheidsgraad van de werkomgeving van de machine mag niet hoger zijn dan 50% bij 40°C (104°F).

De vochtigheidsgraad van de werkomgeving van de machine mag niet hoger zijn dan 90% bij 20°C (68°F).

De machine kan worden gebruikt tot op een hoogte van 2000 meter boven de zeespiegel (6500 voet).



- Gebruik de machine niet om pijpen te ontdooien.
- Gebruik de machine niet om batterijen en/of accu's op te laden.
- Gebruik de machine niet om motoren mee te starten.

1.2 Bescherming voor de lasser en anderen



Bij het lasproces en ontstaan schadelijke stoffen zoals straling, lawaai, hitte en gasuitstoot. Plaats een vuurvast scherm om het lasgebied ter bescherming tegen straling, vonken en gloeiend afval. Adviseer iedereen in de nabijheid niet rechtstreeks in de lasboog of het gloeiende metaal te kijken en om een laskap te gebruiken.



Draag beschermende kleding om uw huid te beschermen tegen straling vonken en gloeiende metaalsplinters. De kleding moet het gehele lichaam bedekken:

- heel en van goede kwaliteit zijn
- vuurvast
- isolerend en droog
- goed passend en zonder manchetten en omslagen



Draag altijd goed, stevig waterdicht schoeisel.
Draag altijd goede hitte- en stroombestendige handschoenen.



Draag een laskap met zijflappen en met een geschikte lasruit (minimale sterkte nr. 10 of hoger) voor de ogen.



Draag altijd een veiligheidsbril met zijbescherming vooral tijdens het handmatig of mechanisch verwijderen van las afval.



Draag geen contactlenzen!



Gebruik gehoorbescherming als tijdens het lassen het geluidsniveau te hoog wordt. Als het geluidsniveau de wettelijk vastgestelde waarde overschrijdt moet de werkplek worden afgeschermd en moet iedereen die in de nabijheid komt gehoorbescherming dragen.



Laat de zijpanelen tijdens het lassen altijd gesloten. De installatie mag op geen enkele manier worden gewijzigd.



Laat de zijpanelen tijdens het lassen altijd gesloten. Zorg ervoor dat uw handen, haar, kleding, gereedschap niet in aanraking kunnen komen met bewegende onderdelen zoals: ventilatoren, tandwielen, rollen en assen, draadspoelen. Raak tandwielen niet aan wanneer de draadtoevoer ingeschakeld is. De installatie mag op geen enkele manier worden gewijzigd. Het buitenwerking stellen van het beveiligingsmechanisme op de draadaanvoer unit is buitengewoon gevaarlijk en ontheft de fabrikant van alle verantwoordelijkheid voor letsel en schade aan personen en hun eigendommen.



Houdt tijdens het tijdens het laden en toevoeren van de draad uw hoofd weg van de MIG/MAG toorts. De uitgaande draad kan ernstig letsel veroorzaken aan handen, gezicht en ogen.



Raak zojuist gelaste voorwerpen niet aan, de grote hitte kan brandwonden veroorzaken. Volg alle veiligheidsvoorschriften op, ook tijdens bewerkingen na het lassen. Er kunnen tijdens het afkoelen van het werkstuk nog slakken loslaten.



Controleer vooraf of de toorts koud is voor u begint met lassen of met onderhoud begint.



Overtuig u ervan dat de koelunit is uitgeschakeld voordat u de leidingen van de koelvloeistof losmaakt. De hete vloeistof uit de leidingen kan ernstige brandwonden veroorzaken.



Houd een verbanddoos binnen handbereik. Onderschat brandwonden of andere verwondingen nooit.



Overtuigt u er voor dat u vertrekt van dat de werkplek goed is opgeruimd, zo voorkomt u ongevallen.

NL

1.3 Bescherming tegen rook en gassen



Rook, gassen en stoffen die tijdens het lassen vrijkomen, kunnen gevaarlijk zijn voor de gezondheid. Onder bepaalde omstandigheden kan de lasrook kanker veroorzaken en bij zwangerschap de foetus schaden.

- Houdt u hoofd ver van de lasrook en gassen.
- Zorg voor goede ventilatie, natuurlijke of mechanische, op de werkplek.
- Gebruik bij slechte ventilatie maskers of verse lucht helmen.
- Bij het lassen in extreem kleine ruimten verdient het aanbeveling de lasser door een collega buiten de ruimte scherp in de gaten te laten houden.
- Gebruik geen zuurstof om te ventileren.
- Controleer of de afzuiging goed werkt door regelmatig na te gaan of schadelijke gassen in de luchtmonsters onder de norm blijven.
- De hoeveelheid en de mate van gevaar van de rook hangt af van het materiaal dat gelast wordt, het lasmateriaal en het schoonmaakmiddel dat is gebruikt om het werkstuk schoon en vetvrij te maken. Volg de aanwijzingen van de fabrikant en de bijgeleverde technische gegevens.
- Las niet direct naast plaatsen waar ontvet of geveerd wordt.
- Plaats gasflessen buiten of in goed geventileerde ruimten.

1.4 Brand en explosie preventie



Het las proces kan brand en/of explosies veroorzaken.

- Verwijder alle brandbare en lichtontvlambare producten van de werkplek en omgeving.
- Brandbare materialen moeten minstens op 11 meter (35 voet) van de lasplaats worden opgeslagen of ze moeten goed afgeschermd zijn.
- Vonken en gloeiende deeltjes kunnen makkelijk ver weg springen, zelfs door kleine openingen. Geef veel aandacht aan de veiligheid van mens en werkplaats.
- Las nooit boven of bij containers die onder druk staan.
- Las nooit in gesloten containers of buizen. Resten van gas, brandstof, olie of soortgelijke stoffen kunnen explosies veroorzaken.

- Las niet op plaatsen waar explosieve stoffen, gassen of dampen zijn.
- Controleer na het lassen of de stroomtoevoer niet per ongeluk contact maakt met de aardkabel.
- Installeer brandblusapparatuur in de omgeving van de werkplek.

1.5 Voorzorgmaatregelen voor het gebruik van gasflessen



Gasflessen zijn onder druk gevuld en kunnen exploderen als de veiligheidsvoorschriften niet in worden nageleefd bij vervoer, opslag en gebruik.

- De flessen moeten rechtop verankerd staan aan een muur of een andere stevige constructie zodat ze niet per ongeluk kunnen omvallen of tegen iets aanstoten.
- Draai de beschermkap van het ventiel goed vast tijdens transport, bij het aansluiten en bij het lassen.
- Stel de flessen niet bloot aan direct zonlicht of grote temperatuurschommelingen. Stel de flessen niet bloot aan extreme koude of hoge temperaturen.
- Laat de gasflessen niet in aanraking komen met open vuur, elektrische stroom, lastoortsen of elektrische klemmen of met wegspringende vonken en splinters.
- Houdt de gasflessen altijd uit de buurt van las- en stroomcircuits.
- Draai uw gezicht af wanneer u het ventiel van de gasfles open draait.
- Draai het ventiel van de gasfles na het werk altijd dicht.
- Las nooit aan gasflessen die onder druk staan.
- Een persluchtflus onder druk mag nooit direct gekoppeld worden aan het reduceerventiel van de lasmachine. De druk zou hoger kunnen zijn dan het vermogen van het reduceerventiel waardoor hij zou kunnen exploderen.

1.6 Beveiliging tegen elektrische schokken



Elektrische schokken kunnen dodelijk zijn.

- Vermijd het aanraken van spanningvoerende delen binnen of buiten de lasapparatuur terwijl de apparatuur zelf onder spanning staat (toortsen, klemmen, massakabels, elektroden, draden, haspels en spoelen zijn elektrisch verbonden met het lascircuit).
- Zorg voor elektrische isolatie van het systeem en de bediener door droge vloeren en ondergronden te gebruiken die voldoende geïsoleerd zijn van het massa- en aardingspotentiaal.
- Overtuigt u ervan dat de machine goed is aangesloten aan de contactdoos en dat de krachtbron voorzien is van een aardkabel.
- Raak nooit twee toortsen of elektrodehouders tegelijk aan.
- Stop direct met lassen als u een elektrische schok voelt.

1.7 Elektromagnetische velden en storingen



De stroom die intern en extern door de kabels van de machine gaat veroorzaakt een elektromagnetisch veld rondom de kabels en de machine.

- Deze elektromagnetische velden zouden een negatief effect kunnen hebben op mensen die er langere tijd aan bloot gesteld zijn. (de juiste effecten zijn nog onbekend).
- Elektromagnetische velden kunnen storingen veroorzaken bij hulpmiddelen zoals pacemakers en gehoorapparaten.



Personen die een pacemaker hebben moeten eerst hun arts raadplegen voor zij las- of plasma snijwerkzaamheden gaan uitoefenen.

1.7.1 EMC classificatie in overeenstemming met: EN 60974-10/A1:2015.



Klasse B apparatuur voldoet aan de elektromagnetische eisen van aansluiting zowel wat betreft de industriële omgeving als de woonomgeving, inclusief de woonomgeving waar de stroomvoorziening wordt betrokken van het netwerk en dus met een lage spanning.



Klasse A apparatuur is niet bedoeld om te gebruiken in de woonomgeving waar de stroom geleverd wordt via het normale netwerk met lage spanning. In een dergelijke omgeving kunnen zich potentiële moeilijkheden voordoen bij het veilig stellen van de elektromagnetische aansluiting van klasse A apparatuur veroorzaakt door geleiding of storing door straling.

Zie voor meer informatie: GEGEVENSPLAAT of TECHNISCHE KENMERKEN.

1.7.2 Installatie, gebruik en evaluatie van de werkplek

Deze apparatuur is gebouwd volgens de aanwijzingen in de geharmoniseerde norm EN 60974-10/A1:2015 en wordt gerekend tot de Klasse A. Deze apparatuur dient uitsluitend voor professionele doeleinde te worden gebruikt in een industriële omgeving. De fabrikant kan niet aansprakelijk worden gesteld voor schade veroorzaakt door gebruik van de apparatuur in een huishoudelijke omgeving.



De gebruiker moet een vakkundig iemand zijn die zich verantwoordelijk voelt voor de apparatuur en er gebruik van maakt volgens de richtlijnen van de fabrikant. Wanneer zich elektromagnetische storingen voordoen moet de lasser de problemen oplossen zonedig met de technische assistentie van de fabrikant.



In ieder geval dient de elektromagnetische storing zodanig gereduceerd te worden dat het geen hinder meer vormt.



Voor de installatie dient de gebruiker de risico's te evalueren die elektromagnetische storingen zouden kunnen opleveren voor de directe omgeving, hierbij in het bijzonder lettend op de gezondheidsrisico's voor personen op en in de omgeving van de werkplek, bij voorbeeld mensen die een pacemaker of een gehoorapparaat hebben.

1.7.3 Eisen voor het leidingnet

Apparatuur op hoogspanning kan, ten gevolge van de eerste stroom die wordt betrokken van het gewone netwerk, de kwaliteit beïnvloeden van de stroom van het hoogspanningsnet. Daarom zijn aansluitingsbeperkingen of eisen ten aanzien van de maximaal toelaatbare stroomsterkte van wisselstroom (Z_{max}) of de noodzakelijke minimale toevoer (Ssc) capaciteit op de interface van het normale hoogspanning netwerk (punt van normale koppeling, PCC) kan van toepassing zijn bij sommige typen apparatuur. (zie de technische informatie). In dat geval is het de verantwoordelijkheid van de installateur of van de gebruiker van de apparatuur om zich ervan te vergewissen, zonedig door de netwerkbeheerder te raadplegen, dat de apparatuur mag worden aangesloten. In het geval er storingen optreden kan het aanbeveling verdienen om verdere voorzorgmaatregelen te nemen zoals het filteren van de stroomtoevoer.

Het is ook noodzakelijk om de mogelijkheid te overwegen de stroomkabel af te schermen.

Zie voor meer informatie: TECHNISCHE KENMERKEN.

1.7.4 Voorzorgmaatregelen voor kabels

Om de effecten van de elektromagnetische velden zo klein mogelijk te houden dient u de hieronder staande richtlijnen te volgen:

- Houdt de laskabel en de aardkabel zoveel mogelijk bij elkaar opgerold.
- Vermijdt dat de kabels rond uw lichaam draaien.
- Vermijdt dat u tussen de aard- en de laskabel in staat, (houdt beide aan één kant).
- De kabels moeten zo kort mogelijk gehouden worden, bij elkaar gehouden op of zo dicht mogelijk bij de grond.
- Plaats de apparatuur op enige afstand van de werkplek.
- Houdt de kabels ver verwijderd van andere kabels.

1.7.5 Geaarde verbinding van de installatie

Het wordt aanbevolen alle verbindingen van alle metalen onderdelen in de las machine en in de omgeving ervan te aarden. Deze verbindingen dienen te zijn gemaakt volgens de plaatselijk geldende veiligheids regels.

1.7.6 Het werkstuk aarden

Wanneer het werkstuk niet geaard is vanwege elektrische veiligheid, de afmeting of de plaats waar het staat kan het aarden van het werkstuk de straling verminderen. Het is belangrijk er aan te denken dat het aarden van het werkstuk zowel het gevaar voor de lasser op ongelukken als schade aan andere apparatuur niet mag vergroten. Het aarden moet volgens de plaatselijke veiligheidsvoorschriften gebeuren.

1.7.7 Afscherming

Door het selectief afschermen van andere kabels en apparatuur in de directe omgeving kunnen de storingsproblemen afnemen. Bij speciale toepassingen kan het worden overwogen de gehele lasplaats af te schermen.

1.8 IP Beveiligingsgraad



IP23S

- De kast voorkomt dat gevaarlijke onderdelen met de vingers of voorwerpen met een diameter tot 12.5mm kunnen worden aangeraakt.
- De kast beschermt tegen inregenen tot een hoek van 60° in verticale stand.
- De kast beschermt tegen de gevolgen van binnen druppelend water als de machine niet aanstaat.

1.9 Verwijdering



Verwijder elektrische apparatuur niet bij het normale afval!

In overeenstemming met de Europese Richtlijn 2012/19/EU betreffende afgedankte elektrische en elektronische apparatuur en de uitvoering daarvan in overeenstemming met de nationale wetgevingen, moet elektrische apparatuur die het einde van haar levenscyclus heeft bereikt, gescheiden worden ingezameld en naar een centrum voor nuttige toepassing en verwijdering worden gebracht. De eigenaar van de apparatuur dient bij de plaatselijke autoriteiten te informeren naar de erkende inzamel punten. Door toepassing van de Europese richtlijn kunnen het milieu en de menselijke gezondheid worden verbeterd.

2. HET INSTALLEREN



Het installeren dient te worden gedaan door vakkundig personeel met instemming van de fabrikant.



Overtuigt u ervan dat de stroom is uitgeschakeld voordat u gaat installeren.



Het is verboden om stroombronnen in serie of in parallel te schakelen.

2.1 Procedure voor het laden, vervoeren en lossen

- De machine is uitgerust met een handgreep voor transport.
- De machine is niet uitgerust met speciale hulpstukken voor bij het tillen.
- Gebruik een vorkheftruck maar let op dat de machine niet kantelt.



Underschat het gewicht van de apparatuur niet, zie de technische specificatie.
Beweeg of hang het apparaat nooit boven personen of voorwerpen.
Laat het apparaat niet vallen of botsen.

2.2 Plaatsen van de installatie



Houdt u aan onderstaande regels:

- Zorg ervoor dat de installatie en de aansluitingen goed toegankelijk zijn.
- Plaats het apparaat niet in een te kleine ruimte.
- Plaats het apparaat niet op een schuin aflopende ondergrond van meer dan 10° waterpas.
- Plaats het apparaat in een droge, schone en goed geventileerde ruimte.
- Bescherm het apparaat tegen hevige regen en tegen de zon.

2.3 Aansluiting

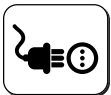

De stroombron is voorzien van een primaire stroomkabel voor de aansluiting op het lichtnet.
De installatie kan worden gevoed door:

- 400 V drie fase
- 230 V drie fase

De werking van het apparaat wordt gegarandeerd voor spanningswaarden tot $\pm 15\%$ ten opzichte van de nominale waarde (voorbeeld: met V_{nom} 400V is de werkbare spanning tussen 320V en 440 V).



Om lichamelijk letsel en schade aan de apparatuur te voorkomen moet u de geselecteerde netspanning en de zekeringen controleren voor u de machine op het net aansluit. Controleer ook of het stopcontact geaard is.



De machine kan gevoed worden door een stroomaggregaat als deze een stabiele voedingsspanning garandeert van $\pm 15\%$ van de door de fabrikant voorgeschreven nominale behoefte, zodat onder alle werkomstandigheden en met maximale capaciteit gelast kan worden. Wij adviseren bij één fase lasapparaat een stroomaggregaat te gebruiken die tweemaal het vermogen van de stroombron geeft, in geval van drie fase lasapparaat is dit $1\frac{1}{2}$. Het gebruik van een stroomaggregaat met elektrische bediening wordt aangeraden.



Ter bescherming van de gebruikers moet de installatie goed geaard zijn. De stroom kabel is voorzien van een aarde kabel (geel-groen), en moet worden verbonden met een geaarde stekker. Deze geel/groene draad mag nooit worden gebruikt met andere stroomdraden. Controleer de aardverbinding op de werkplek en of de stopcontacten in goede staat verkeren. Installeer alleen stekkers die voldoen aan de veiligheids eisen.



Het elektrische systeem moet worden aangesloten door vakkundig technisch personeel met de juiste kwalificaties en volgens de nationale veiligheids normen.

2.4 Installeren

2.4.1 Aansluiting voor het MMA lassen



De aansluiting zoals u die ziet op de afbeelding is de algemene situatie bij MMA lassen, d.w.z. de electrodehouder is verbonden met de plus pool en de aardklem met de min pool.

Wilt u lassen met een omgekeerde polariteit dan dient u de te verwisselen, sommige electrode vragen hierom.

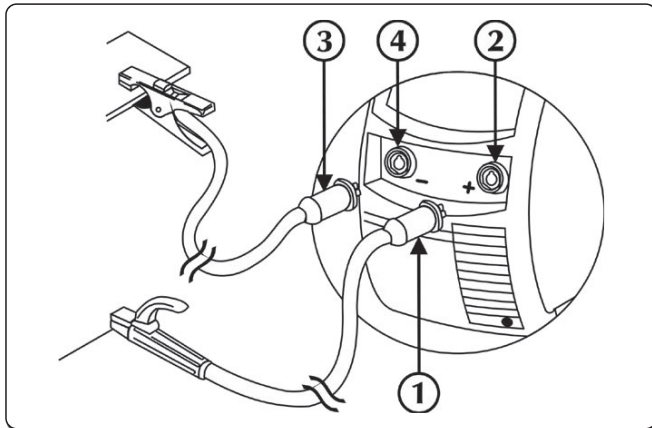

- ① Connector voor aardingsklem
- ② Negatief contactpunt (-)
- ③ Connector voor elektrodehouder
- ④ Positief contactpunt (+)

- ▶ Verbind de aardklem aan de negatieve snelkoppeling (-) van de stroombron. Plaats de stekker en draai met de klok mee tot hij stevig vast zit.
- ▶ Verbind de elektrodehouder aan de positieve snelkoppeling (+) van de stroombron. Plaats de stekker en draai met de klok mee tot hij stevig vast zit.

2.4.2 Aansluiting voor het TIG lassen

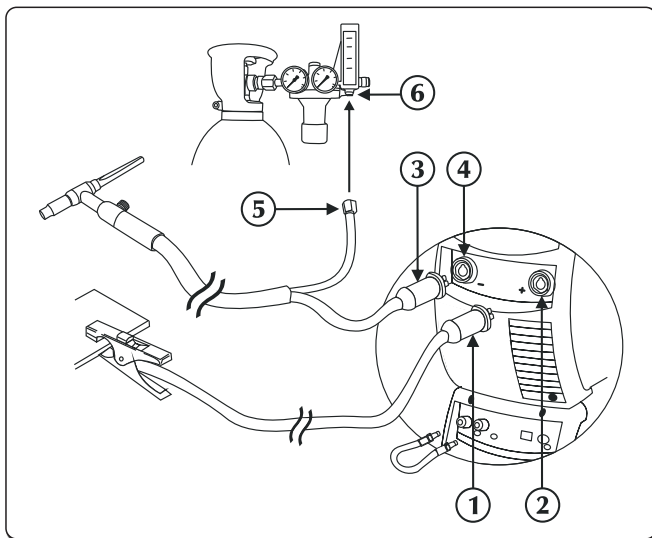



- ① Connector voor aardingsklem
- ② Positief contactpunt (+)
- ③ TIG toorts aansluiting
- ④ Zaklamp aansluiting
- ⑤ Gasleiding connector
- ⑥ Druk regelaar

- ▶ Verbind de aardklem aan de positieve snelkoppeling (+) van de stroombron. Plaats de stekker en draai met de klok mee tot hij stevig vast zit.
- ▶ Verbind de TIG toorts koppeling aan de snelkoppeling (-) van de stroombron. Plaats de stekker en draai met de klok mee tot hij stevig vast zit.



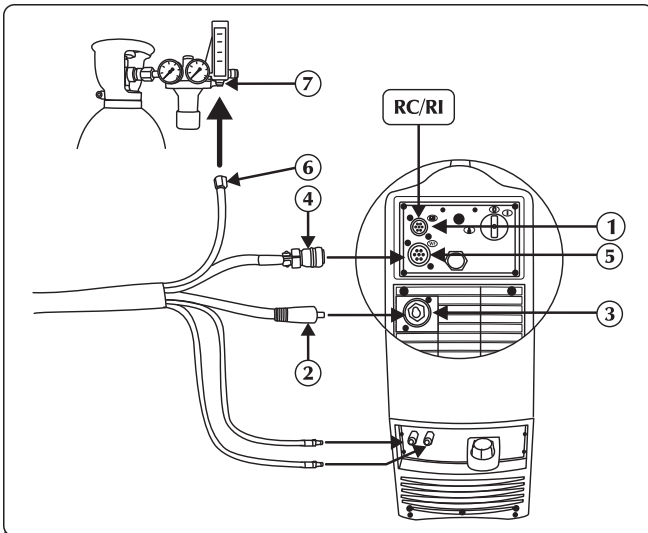

U doseert de gastoevoer met de regelkraan die over het algemeen op de TIG toorts lastang zit.

- ▶ Verbind de gastoevoer van de TIG toorts apart aan het reduceerventiel.
- ▶ Verbindt de slang voor koelvloeistof (kleur rood) van de toorts met de snelkoppeling (kleur rood - symbool ) van de koelunit.
- ▶ Verbindt de slang voor koelvloeistof (kleur blauw) van de toorts met de snelkoppeling (kleur blauw - symbool ) van de koelunit.

2.4.3 Verbinding voor MIG/MAG lassen

- ① Signaalkabel (CAN-BUS) ingang
- ② Stroomkabel
- ③ Positief contactpunt (+)
- ④ Signaalkabel
- ⑤ Ingang signaalkabel (CAN-BUS) (kabelbundel)
- ⑥ Gasbuis
- ⑦ Aansluiting gastoevoer

- ▶ Verbindt de stroomkabel met het juiste contactpunt. Plaats de stekker en draai met de klok mee tot hij stevig vast zit.
- ▶ Verbindt de signaalkabel met de juiste aansluitklem. Plaats de aansluitklem en draai de ringmoer met de klok mee aan tot de delen goed vast zitten.
- ▶ Verbindt de gasslang met het reduceerventiel van de gasfles of aan het gastoevoer koppelstuk. Stel de gasstroom in van 10 tot 30 l/min.
- ▶ Verbindt de slang voor de koelvloeistof (kleur blauw) van het tussenpakket met de snelkoppeling (kleur blauw - symbool ) van de koelunit.
- ▶ Verbindt de slang voor de koelvloeistof (kleur rood) van het tussenpakket met de snelkoppeling (kleur rood - symbool ) van de koelunit.

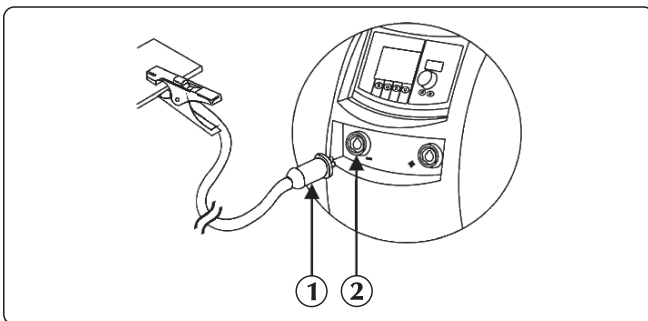

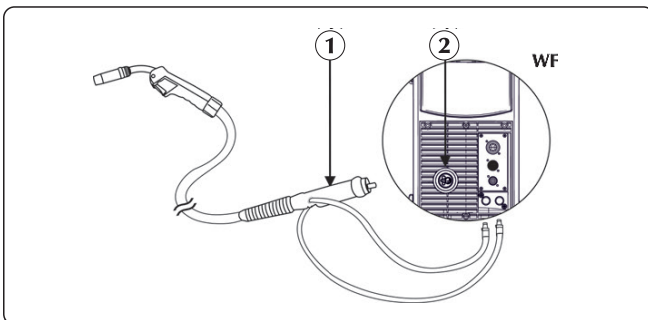

- ① Connector voor aardingsklem
- ② Negatief contactpunt (-)

- ▶ Verbind de aardklem aan de negatieve snelkoppeling (-) van de stroombron. Plaats de stekker en draai met de klok mee tot hij stevig vast zit.



- ① Toortsaansluiting
- ② Verbinding

- ▶ Verbindt de slang voor koelvloeistof (kleur blauw) van de toorts met de snelkoppeling (kleur blauw - symbool ) van de koelunit.
- ▶ Verbindt de slang voor koelvloeistof (kleur rood) van de toorts met de snelkoppeling (kleur rood - symbool ) van de koelunit.
- ▶ Sluit de MIG/MAG toorts aan de centrale adapter aan en overtuig u ervan dat de bevestigingsring goed is vastgedraaid.

3. PRESENTATIE VAN DE INSTALLATIE

3.1 Achter paneel

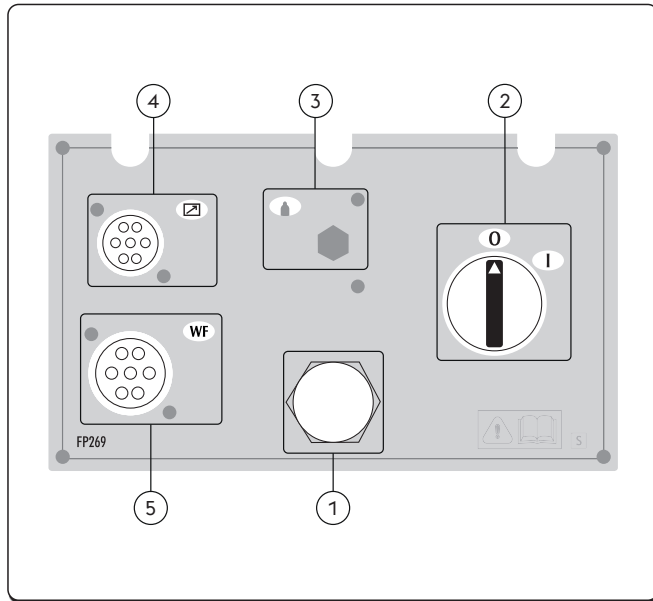

- ① **Elektrischeitskabel**
Verbindt de machine met het stroomnet.
- ② **An/uit schakelaar**
Knop om de netspanning in te schakelen.
De schakelaar heeft 2 standen: "0" uit, "I" aan.
- ③ **Niet gebruikt**
- ④ **Signaalkabel CAN-BUS ingang (RC, RI...)**
- ⑤ **Ingang signaalkabel (CAN-BUS) (kabelbundel)**

3.2 Paneel met contactpunten

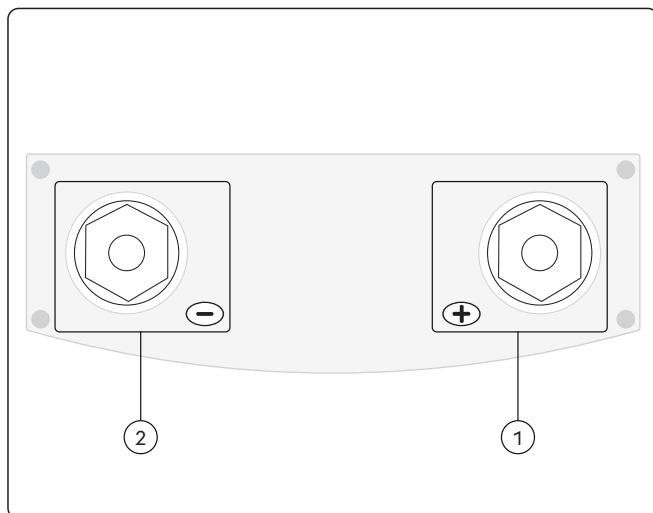

- ① **Positief contactpunt (+)**
Proces MMA: Aansluiting elektrode toorts
Proces TIG: Aansluiting aardingskabel
- ② **Negatief contactpunt (-)**
Proces MMA: Aansluiting aardingskabel
Proces TIG: Aansluiting toorts
MIG/MAG-proces: Aansluiting aardingskabel

3.3 Bedieningspaneel vooraan

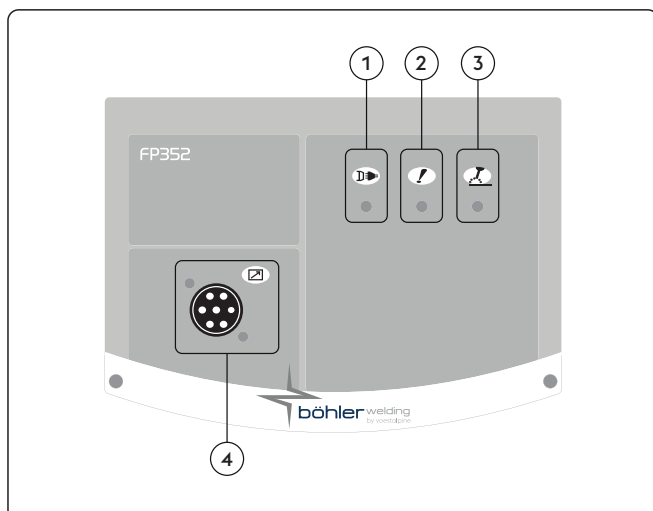

- ① **Voedingsled**
Geeft aan dat de stroom is ingeschakeld en de machine aan staat.
- ② **Algemeen alarm-led**
Geeft aan dat het beveiligingssysteem een mogelijke storing constateert zoals bij voorbeeld bij een te hoge temperatuur.
- ③ **Actief vermogen-led**
Geeft aan dat de boogspanning is geactiveerd.
- ④ **Signaalkabel CAN-BUS ingang (RC, RI...)**

3.4 Bedieningspaneel vooraan

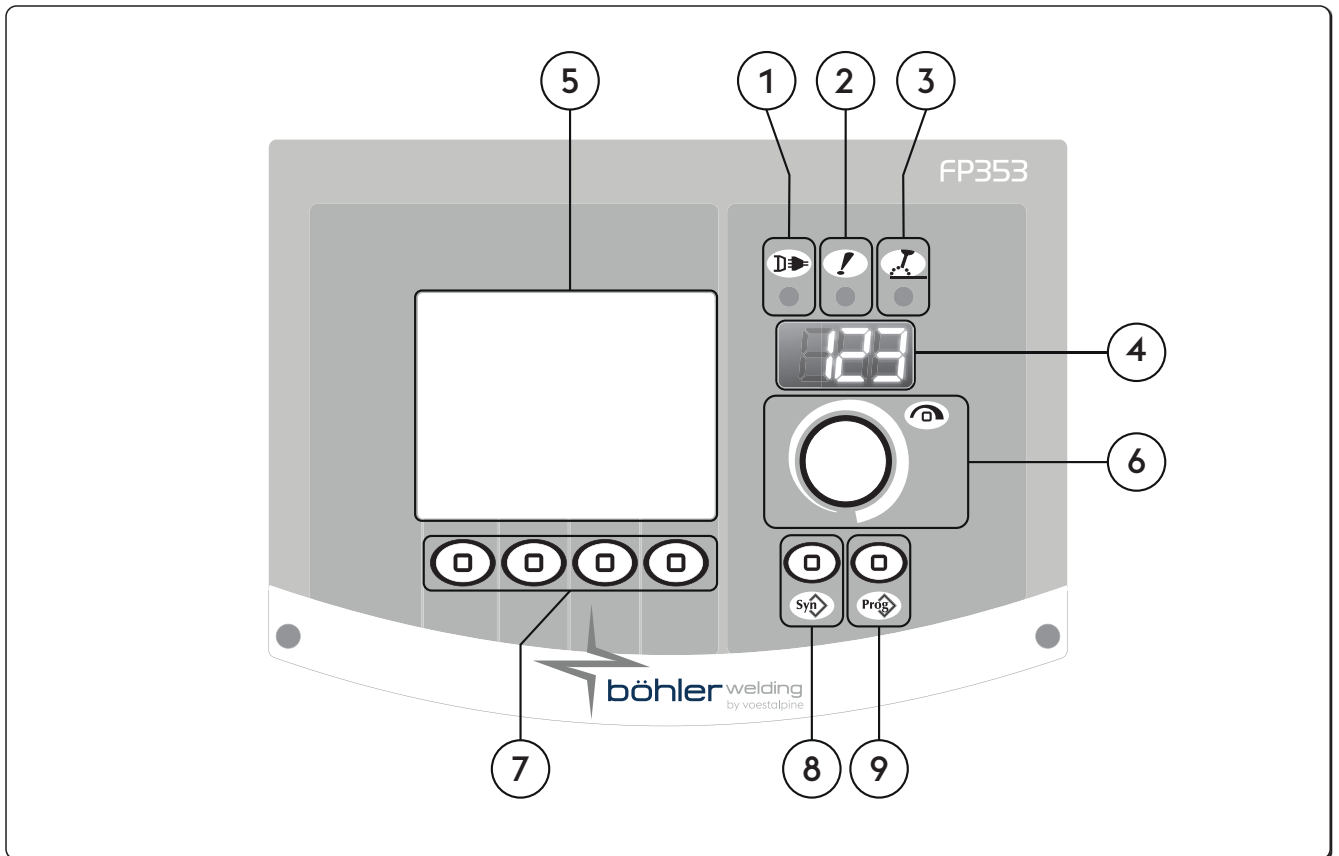

- 1  **Voedingsled**
Geeft aan dat de stroom is ingeschakeld en de machine aan staat.
- 2  **Algemeen alarm-led**
Geeft aan dat het beveiligingssysteem een mogelijke storing constateert zoals bij voorbeeld bij een te hoge temperatuur.
- 3  **Actief vermogen-led**
Geeft aan dat de boogspanning is geactiveer.
- 4  **7-segmenten display**
Zorgt ervoor dat u de waarden van de parameters kunt aflezen tijdens het opstarten van de machine, de instellingen, de stroomtoevoer en de voltage tijdens het lassen, en de alarm codes.
- 5  **LCD display**
Zorgt ervoor dat u de waarden van de parameters kunt aflezen tijdens het opstarten van de machine, de instellingen, de stroomtoevoer en de voltage tijdens het lassen, en de alarm codes.
Maakt het mogelijk dat alle handelingen direct getoond worden.
- 6  **Belangrijkste instellingsknop**
Staat het opstarten toe. De keuze en de instelling van de las parameters.
- 7  **Functietoetsen**
Hiermee kunnen de verschillende functies van de installatie geïnstalleerd worden:
- Las-proces
- Las methodes
- Pulserende stroom
- Grafische modus

8 **Programmatoets**

Hiermee kan een vooraf ingesteld lasprogramma geselecteerd worden via onderstaande informatie:

- Soort draad
- type gas
- Draad diameter

9 **Toets job**

Maakt het opslaan en besturen mogelijk van 240 las programma's die door de lasser gepersonifieerd zijn.

4. GEBRUIK VAN APPARATUUR

4.1 Start scherm

Wanneer hij is ingeschakeld, voert de stroombron een aantal controles uit om de juiste werking van het systeem en van alle aangesloten apparatuur te garanderen. In dit stadium wordt de gas test ook uitgevoerd om de juiste aansluiting te controleren van het gastoevoer systeem.

4.2 Test scherm

Wanneer het zijpaneel (draadkoffer) is geopend is het verboden om te lassen. Het test scherm verschijnt op het LCD display.

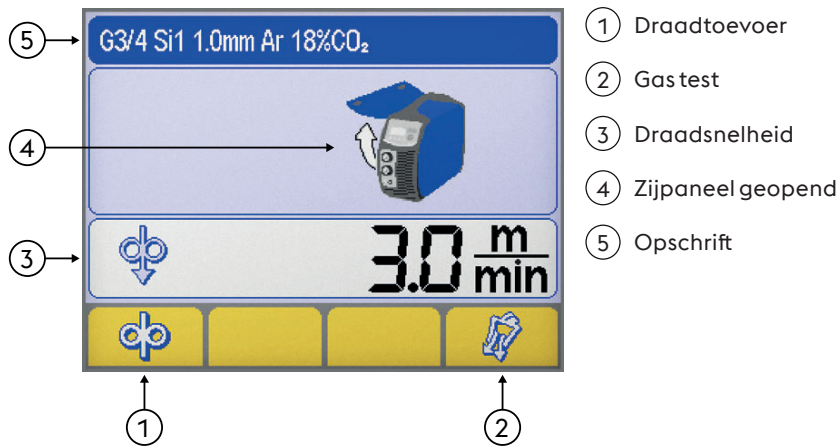

NL



Draadtoevoer

Maakt handmatige draadtoevoer mogelijk zonder gastoevoer. Maakt het insteken van de draad in de toorts mogelijk tijdens de voorbereidingen van het lassen.



Gas test

Maakt het mogelijk de gasleiding te reinigen van onzuiverheden en om, zonder stroom verlies, de juiste inleidende gasdruk en de gas toevoer in te stellen.



Draadsnelheid

Maakt de regeling mogelijk van de snelheid van de draadtoevoer (tijdens het laden fase).

Minimaal	Maximaal	Fabrieksinstelling
0.5 m/min	22.0 m/min	3.0 m/min



Zijpaneel geopend



Opschrift

Maakt bepaalde belangrijke informatie zichtbaar die betrekking hebben op het geselecteerde proces.

4.3 Hoofd scherm

Maakt de controle mogelijk van het systeem en het las proces en laat de hoofd instellingen zien.

4.4 Hoofdscherm MMA-proces

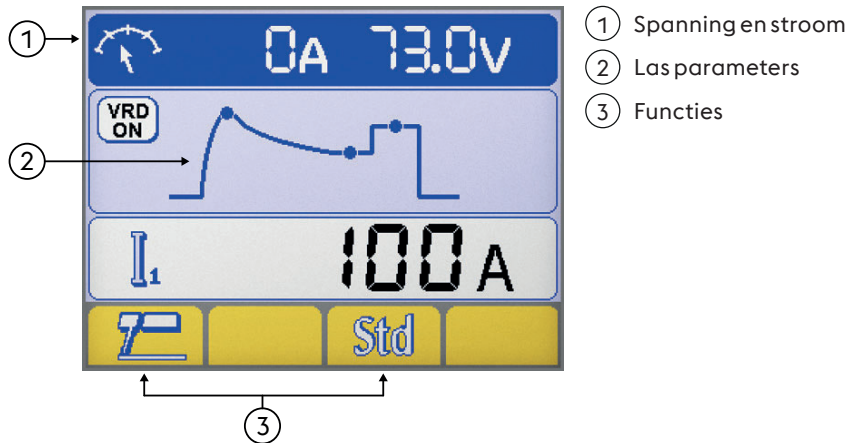

Spanning en stroom

Tijdens het lasproces worden het werkelijke stroom verbruik en het voltage getoond op het LCD display.

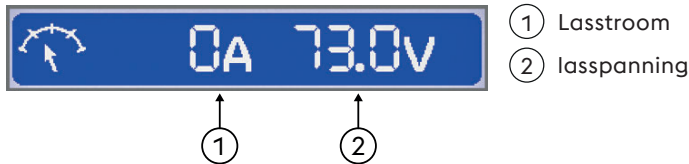

Las parameters

► Selecteer de gewenste parameter door de codeerknop in te drukken.

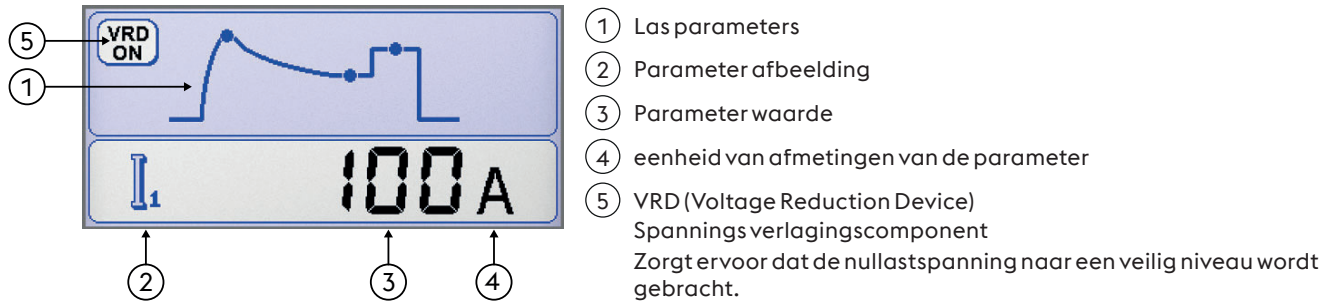

Functies

Maakt het mogelijk de belangrijkste proces functies en las methoden in te stellen.

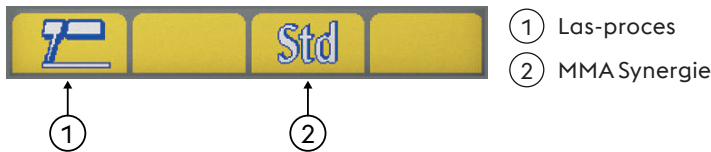



MMA Synergie

Hiermee kan de beste boogdynamiek worden ingesteld door het selecteren van het type elektrode dat u gaat gebruiken.

Het kiezen van de juiste dynamische boog maakt het mogelijk om het maximaal profijt uit de stroombron te halen zodat de best mogelijk las prestatie wordt behaald.

Standard (Basisch/Rutiel)	Cellulose	Staal	Aluminium	Gietijzer



Perfekte lasbaarheid van de gebruikte elektrode wordt niet gegarandeerd.

De lasbaarheid is afhankelijk van de kwaliteit en de staat waarin het artikel verkeerd, de werk- en lascondities, en vele mogelijke toepassingen, enz.

4.5 Hoofdscherm TIG-proces

① Spanning en stroom
② Las parameters
③ Functies

Spanning en stroom

Tijdens het lasproces worden het werkelijke stroom verbruik en het voltage getoond op het LCD display.

① Lasstroom
② lasspanning

Las parameters

① Las parameters
▶ Selecteer de gewenste parameter door de codeerknop in te drukken.
▶ Pas de waarde van de geselecteerde parameter aan door de codeerder te draaien.
② Parameter afbeelding
③ Parameter waarde
④ eenheid van afmetingen van de parameter

Functies

Maakt het mogelijk de belangrijkste proces functies en las methoden in te stellen.

① Las-proces

NL



4.6 Hoofdscherm MIG/MAG-proces

Basisscherm

① Opschrift MIG/MAG
 ② Las parameters
 ③ Functies

Grafisch scherm

① Opschrift MIG/MAG
 ② Las parameters
 ③ Functies

Opschrift MIG/MAG

Maakt bepaalde belangrijke informatie zichtbaar die betrekking hebben op het geselecteerde proces.

G3/4 Si1 1.0mm Ar 18%CO₂

- ① ② ③

Geselecteerde synergische gebogen lijn

- ① type vul metaal
 ② Draad diameter
 ③ type gas

I 118A 2.2mm 3.4mm V 19.5V

- ① ② ③ ④

Las parameters

- ① Lasstroom
 ② Stukdikte
 ③ Hoeklasnaad
 ④ lasspanning

Las parameters (Basisscherm)

► Selecteer de gewenste parameter door de codeerknop in te drukken.

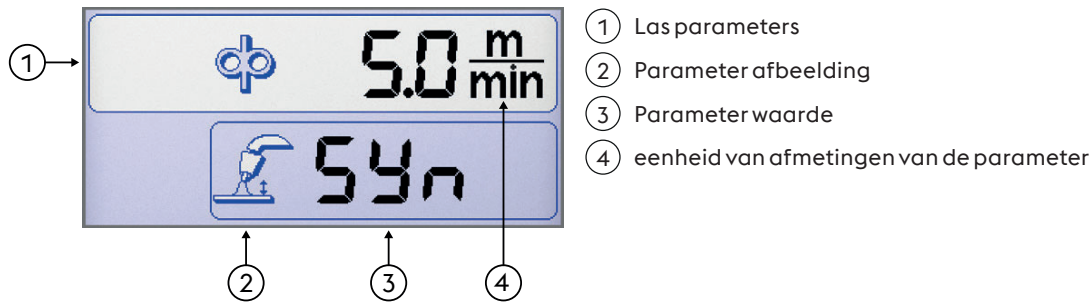

- ① Las parameters
- ② Parameter afbeelding
- ③ Parameter waarde
- ④ eenheid van afmetingen van de parameter

Las parameters (Grafisch scherm)

► Selecteer de gewenste parameter door de codeerknop in te drukken.

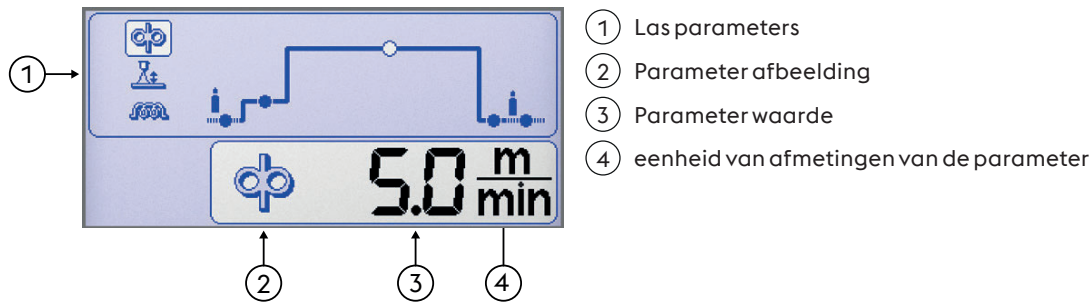

- ① Las parameters
- ② Parameter afbeelding
- ③ Parameter waarde
- ④ eenheid van afmetingen van de parameter

Funcities

Maakt het mogelijk de belangrijkste proces functies en las methoden in te stellen.

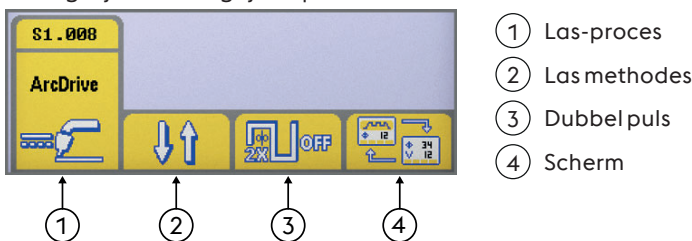

- ① Las-proces
- ② Las methodes
- ③ Dubbel puls
- ④ Scherm

Las-proces



Las methodes

Maakt de keuze mogelijk van de las methode

2 Fasen
De knop indrukken activeert voor de gastoevoer geeft stroom naar de draad en laat hem vooruit gaan; als de knop wordt losgelaten worden de gasdruk en de stroomtoevoer uitgeschakeld.

4 Fasen
Bij 4 fasen zorgt de eerste indruk van de knop ervoor dat het gas gaat stromen met handmatige vooraf gas tijd, het loslaten van de knop activeert de stroomtoevoer naar de draad. Bij de volgende druk op de knop stopt de draad en laat het uiteindelijke proces van start gaan waardoor de stroom afloopt naar 0; laat u uiteindelijk de knop los dan zal de gastoevoer stoppen.

Crater filler
Zorgt ervoor dat u kunt lassen met drie verschillende kracht niveaus die u direct kunt kiezen en controleren door de knop op de toorts te gebruiken.

De eerste druk op de knop maakt dat de gastoevoer van start gaat, activeert de stroomtoevoer naar de draad en voedt hem met de vooraf ingestelde snelheid op de parameter (tijdens het instellen) en met de relatieve synergische waarden van de las parameters.

Als de knop op de toorts wordt losgelaten, veranderen de snelheid van de draad en de relatieve synergie van de parameters automatisch naar de waarden zoals die op het controle paneel zijn ingesteld.

Bij de volgende druk op de knop van de toorts brengt de snelheid van de draad en de relatieve synergie van de parameters tot de vooraf ingestelde (tijdens de instelling) parameter waarden van de gaten vuller. Het loslaten van de knop op de toorts stopt de draadtoevoer en levert de energie voor het terug branden van de na-gas fase.

NL

Dubbel puls

Dubbel puls actief



Dubbel puls niet actief

Scherf

Hiermee kan van weergave worden gewisseld tussen:



Basisscherf



Grafisch scherm

Synergische lijnen scherm

Synergie

Hiermee kan een vooraf ingesteld lasprogramma (synergie) geselecteerd worden via onderstaande informatie

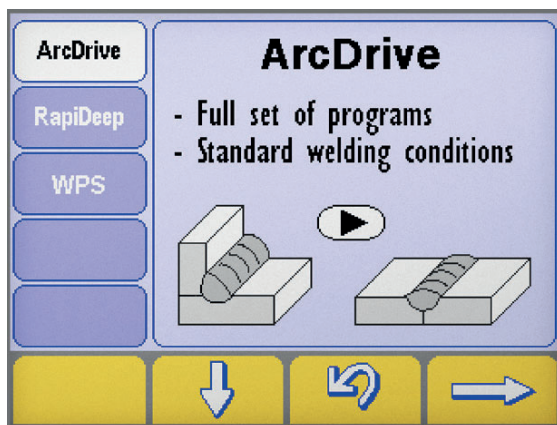
Selectie lasproces

- ▶ Open het scherm "synergische programma's" door de toets ten minste een seconde ingedrukt te houden.
- ▶ Selecteer het gewenste proces via de toetsen e .
- ▶ Druk op de knop om naar de volgende stap te gaan.

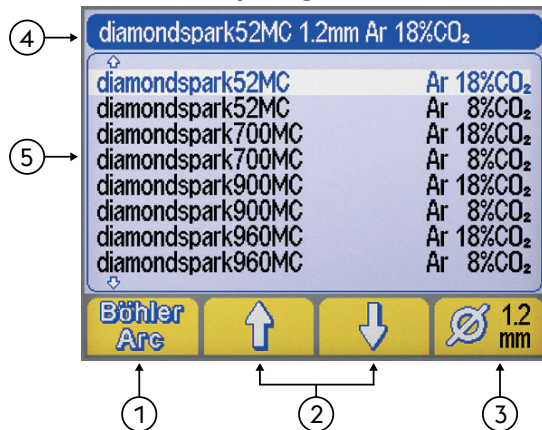
Selectiescherf synergie Soort materiaal/Soort gas

- ① Lasprogramma (BöhlerArc/UniversalArc)
- ② Selectie materiaal/gas
- ③ Draad diameter
- ④ Opschrift
- ⑤ Lasprogramma

Lasprogramma

Maakt de keuze mogelijk van de lasprogramma



BöhlerArc



UniversalArc

Selectie materiaal/gas

Voor keuze van:



- type vul metaal
- type gas



Draad diameter

Kunt u kiezen uit de volgende draad diameter (mm).

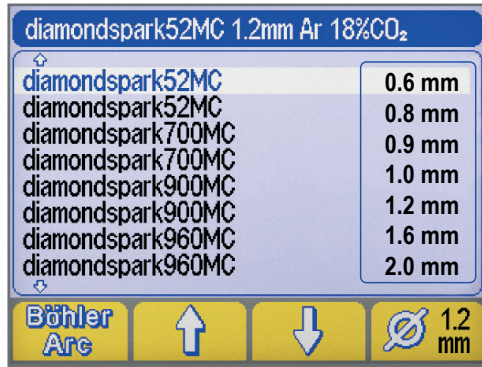

① Draad diameter

①



Opschrift

Maakt bepaalde belangrijke informatie zichtbaar die betrekking hebben op het geselecteerde proces.



NO PROGRAM

Geeft aan dat de geselecteerde synergische curve niet beschikbaar is of niet overeenkomt met de rest van de systeeminstellingen.

4.7 Programma's scherm



Maakt het opslaan en besturen mogelijk van 240 las programma's die door de lasser gepersonifieerd zijn.

Programma's (JOB)

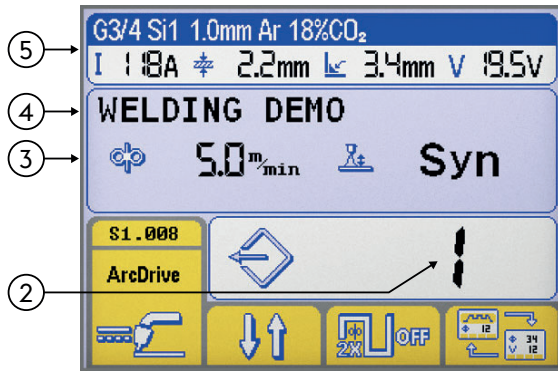

- ① Functies
- ② Nummer van het geselecteerde programma
- ③ Hoofd parameters van het geselecteerde programma
- ④ Beschrijving van het geselecteerde programma
- ⑤ Opschrift

①

Raadpleeg de paragraaf "Hoofdscherm"

Programma opslaan

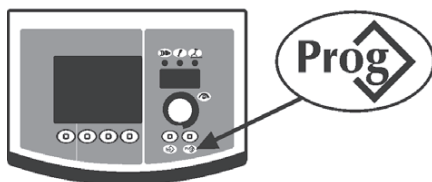

▶ Start het menu "programma opslaan" door de knop **Prog** ten minste een seconde ingedrukt te houden.



▶ Selecteer het gewenste programma (of het lege geheugen) door de decoder te draaien.

--- Geheugen leeg

Programma opgeslagen

▶ Bevestig de handeling door de knop in te drukken **↩**.

▶ Bewaar alle huidige instellingen van het geselecteerde programma door de knop in te drukken. **Save**.



Introduceer een beschrijving van het programma.

- ▶ Selecteer de gewenste letter door de decoder te draaien.
- ▶ Sla de geselecteerde letter op door de decoder in te drukken.
- ▶ Maak de laatste opdracht ongedaan door de knop in te drukken.
- ▶ Bevestig de handeling door de knop in te drukken.
- ▶ Bevestig de handeling door de knop in te drukken.



Het opslaan van een nieuw programma in een reeds vol geheugen maakt het noodzakelijk het geheugen te wissen op de voorgeschreven manier.



- ▶ Bevestig de handeling door de knop in te drukken.
- ▶ Wis het geselecteerde programma door de knop in te drukken.
- ▶ Hervat de procedure opslaan.

Programma ontsluiten

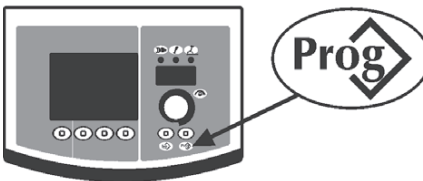

- ▶ Haal het 1e beschikbare programma terug door de knop in te drukken.
- ▶ Selecteer het gewenste programma door de decoder te draaien.
- ▶ Selecteer het gewenste programma door de knop in te drukken.



Alleen de werkprogramma's in het geheugen worden getoond, de programma's die niet in gebruik zijn worden automatisch overgeslagen.

Programma opheffen



- ▶ Selecteer het gewenste programma door de decoder te draaien.
- ▶ Wis het geselecteerde programma door de knop in te drukken.
- ▶ Bevestig de handeling door de knop in te drukken.



- ▶ Bevestig de handeling door de knop in te drukken.
- ▶ Wis het geselecteerde programma door de knop in te drukken.

5. SETUP

5.1 Set up en instelling van de parameters

Zorgt voor het instellen en regelen van een serie extra parameters voor een betere en meer nauwkeurige controle van het lassysteem.

De instelling van de parameters is afhankelijk van het geselecteerde lasproces en hebben een numerieke codering.

Beginnen met de set up



- ▶ Door de encoder-toets 5 seconden in te drukken.
- ▶ De toegang wordt bevestigd door de aanduiding 0 op het display.

Selectie en instelling van de gewenste parameters

- ▶ Draai de codeerknop totdat de numerieke code voor de parameter weergegeven wordt.
- ▶ Als de codeerknop op dat moment wordt ingedrukt wordt de ingestelde waarde voor deze parameter weergegeven en ingesteld.

Set up verlaten

- ▶ Om het gedeelte 'regeling' te verlaten de codeerknop opnieuw indrukken.
- ▶ Om de set up te verlaten, ga naar parameter "0" (opslaan en afsluiten) en de codeerknop in.
- ▶ Bevestig de handeling door de knop in te drukken
- ▶ Om de wijziging op te slaan en de instelling te verlaten drukt u op de knop:

5.1.1 Lijst parameters in de set up (MMA)

0

Opslaan en afsluiten

Om de wijzigingen op te slaan en de parameter te verlaten.



1

Reset

Om alle parameter weer op de fabrieksinstelling terug te brengen.



3

Hot start

Voor het regelen van de waarde van de hot start in MMA.

Voor een min of meer warme start in de fases van de ontsteking van de boog wat de startprocedure makkelijker maakt.



Basisch-elektrode

Minimaal	Maximaal	Fabrieksinstelling
0/uit	500%	80%

Cellulose-elektrode

Minimaal	Maximaal	Fabrieksinstelling
0/uit	500%	150%

CrNi-elektrode

Minimaal	Maximaal	Fabrieksinstelling
0/uit	500%	100%

Aluminium elektrode

Minimaal	Maximaal	Fabrieksinstelling
0/uit	500%	120%

Gietijzeren elektrode

Minimaal	Maximaal	Fabrieksinstelling
0/uit	500%	100%

7

Lasstroom

Voor het afstellen van de lasstroom.

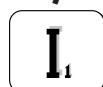

Minimaal	Maximaal	Fabrieksinstelling
3 A	I _{max}	100 A

8 Arc force

Voor het regelen van de waarde van de Arc force in MMA.

Voor een min of meer krachtige dynamische reactie tijdens het lassen waardoor het werken voor de lasser gemakkelijker wordt.

Door de waarde van de arc-force te verhogen wordt de kans op vastkleven van de elektrode verlaagd.

Basisch-elektrode

Minimaal	Maximaal	Fabrieksinstelling
0/uit	500%	30%

Cellulose-elektrode

Minimaal	Maximaal	Fabrieksinstelling
0/uit	500%	350%

CrNi-elektrode

Minimaal	Maximaal	Fabrieksinstelling
0/uit	500%	30%

Aluminium elektrode

Minimaal	Maximaal	Fabrieksinstelling
0/uit	500%	100%

Gietijzeren elektrode

Minimaal	Maximaal	Fabrieksinstelling
0/uit	500%	70%

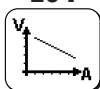
204 Dynamic power control (DPC)

Maakt het mogelijk de gewenste V/A karakteristiek te selecteren.

I=C Constante boog

De toe- of afname van de booglengte heeft geen effect op de lasstroom.

Aanbevolen voor elektrode: Basisch, Rutiel, Acid, Staal, Gietijzer

1:20 Afbouwende karakteristiek met slopeafstelling

De verlenging van de booglengte heeft een verlaging van de lasstroom tot gevolg (en omgekeerd) dit in de verhouding ampere staat tot voltage van 1 tot 20.

Aanbevolen voor elektrode: Cellulose, Aluminium

P=C Wet van behoud van energie

De verlenging van de booglengte veroorzaakt een verlaging van de lasstroom (en omgekeerd) en wel volgens de formule $V \cdot I = K$

Aanbevolen voor elektrode: Cellulose, Aluminium

312 Spanning booguitschakeling

Voor het instellen van de waarde van de spanning om de elektrische boog wordt uitgeschakeld.

Hierdoor worden de werkomstandigheden die zich voordoen beter beheerst.

Bij het puntlassen bijvoorbeeld zorgt een lage waarde van de spanning voor een minder grote vlam als de elektrode van het werkstuk wordt verwijderd waardoor spatten, verbranding en oxidatie van het werkstuk afnemen.

Worden er echter elektroden gebruikt waarvoor een hoge spanning noodzakelijk is, adviseren wij u een hoge drempelwaarde in te stellen om te voorkomen dat de boog tijdens het lassen dooft.



Stel de spanning voor het uitschakelen van de boog nooit hoger in dan nul lading spanning van de stroombron.

Basisch-elektrode

Minimaal	Maximaal	Fabrieksinstelling
0/uit	99.9 V	57.0 V

Cellulose-elektrode

Minimaal	Maximaal	Fabrieksinstelling
0/uit	99.9 V	70.0 V

399 Verplaatsingsnelheid

Hiermee wordt de snelheid ingesteld waarmee het laswerk wordt uitgevoerd.

Default cm/min: referentiesnelheid voor manueel lassen.

Syn: Sinergic waarde.

Minimaal	Maximaal	Fabrieksinstelling
1 cm/min	200 cm/min	15 cm/min

500 Machine-instelling

Maakt het kiezen van de gewenste grafische interface mogelijk.

Maakt de toegang mogelijk tot hogere instelling niveaus.

Raadpleeg het gedeelte "Interface personalisatie (Set up 500)"

Waarde	Gebruikersinterface	Waarde	Geselecteerd niveau
XE	eenvoudige modus	USER	Gebruiker
XA	Gevorderde modus	SERV	Service
XP	Professionele modus	vaBW	vaBW

551 Lock/unlock



Maakt het mogelijk de controle knoppen op het paneel te blokkeren en een bescherm code in te voeren. Raadpleeg het gedeelte "Lock/unlock (Set up 551)".

552 Stapsgewijze aanpassing



Maakt aanpassing mogelijk van de verschillende stappen van de up-down toetsen.

Minimaal	Maximaal	Fabrieksinstelling
0/uit	10	10

601 Stapsgewijze regeling



Maakt het stapsgewijze regelen van de parameter met de persoonlijke instellingen van de lasser mogelijk.

Minimaal	Maximaal	Fabrieksinstelling
1	Imax	1

602 Externe parameter CH1, CH2, CH3, CH4



Maakt de besturing mogelijk van de externe parameter 1, 2, 3, 4 (minimale waarde, maximale waarde, waarde ingesteld door de fabriek, geselecteerde parameter).

Raadpleeg het gedeelte "Beheer van externe controle (Set up 602)".

705 Afstelling weerstand circuit



Voor het afstellen van de apparatuur.

Raadpleeg het gedeelte "Afstelling weerstand circuit (set up 705)".

751 Stroom aflezen



Toont de werkelijke waarde van de lasstroom.

752 Voltage aflezen



Toont de werkelijke waarde van het las voltage.

768 Meting warmtetoevoer HI



Hiermee kan de waarde van de warmtetoevoermeting tijdens het lassen worden afgelezen.

5.1.2 Lijst parameters in setup (TIG)

0 Opslaan en afsluiten



Om de wijzigingen op te slaan en de parameter te verlaten.

1 Reset



Om alle parameter weer op de fabrieksinstelling terug te brengen.

7 Lasstroom



Voor het afstellen van de lasstroom.

Minimaal	Maximaal	Fabrieksinstelling
3 A	Imax	100 A

399 Verplaatsingssnelheid



Hiermee wordt de snelheid ingesteld waarmee het laswerk wordt uitgevoerd.

Default cm/min: referentiesnelheid voor manueel lassen.

Syn: Sinergic waarde.

Minimaal	Maximaal	Fabrieksinstelling
1 cm/min	200 cm/min	10 cm/min

NL

500 Machine-instelling

Maakt het kiezen van de gewenste grafische interface mogelijk.
Maakt de toegang mogelijk tot hogere instelling niveaus.
Raadpleeg het gedeelte "Interface personalificatie (Set up 500)"

Waarde	Gebruikersinterface	Waarde	Geselecteerd niveau
XE	eenvoudige modus	USER	Gebruiker
XA	Gevorderde modus	SERV	Service
XP	Professionele modus	vaBW	vaBW

551 Lock/unlock

Maakt het mogelijk de controle knoppen op het paneel te blokkeren en een bescherm code in te voeren.
Raadpleeg het gedeelte "Lock/unlock (Set up 551)".

552 Stapsgewijze aanpassing

Maakt aanpassing mogelijk van de verschillende stappen van de up-down toetsen.

Minimaal	Maximaal	Fabrieksinstelling
0/uit	10	10

601 Stapsgewijze regeling

Maakt het stapsgewijze regelen van de parameter met de persoonlijke instellingen van de lasser mogelijk.

Minimaal	Maximaal	Fabrieksinstelling
1	lmax	1

602 Externe parameter CH1, CH2, CH3, CH4

Maakt de besturing mogelijk van de externe parameter 1, 2, 3, 4 (minimale waarde, maximale waarde, waarde ingesteld door de fabriek, geselecteerde parameter).
Raadpleeg het gedeelte "Beheer van externe controle (Set up 602)".

705 Afstelling weerstand circuit

Voor het afstellen van de apparatuur.
Raadpleeg het gedeelte "Afstelling weerstand circuit (set up 705)".

751 Stroom aflezen

Toont de werkelijke waarde van de lasstroom.

752 Voltage aflezen

Toont de werkelijke waarde van het las voltage.

755 Gasstroom aflezen (WFR)

Maakt het tonen van de werkelijke waarde van de gasstroom mogelijk.

757 Draadsnelheid aflezen

Encoder motor 1 inlezen.

760 Stroom aflezen (motor 1)

Toont de werkelijke waarde van de motorstroom (motor 1).

764 Koelvloeistofstroom inlezen

Toont de waarde van de koelvloeistofstroom.

NL

765 **Temperatuur koelvloeistof aflezen**



Toont de werkelijke waarde van de temperatuur koelvloeistof.

768 **Meting warmtetoevoer HI**



Hiermee kan de waarde van de warmtetoevoermeting tijdens het lassen worden afgelezen.

801 **Bewaken van limieten**



Maakt het instellen mogelijk van de waarschuwingsgrens en van de bewaking van de limieten.
 Maakt het mogelijk dat het lasproces wordt gecontroleerd door het instellen van waarschuwinglimieten en bewakingslimieten voor de voornaamste meetbare parameters.
 Maakt een accurate controle mogelijk van de diverse las fases.
 Raadpleeg het gedeelte "Bewaken van limieten (Set up 801)".

5.1.3 Lijst parameters in setup (MIG/MAG)

0 **Opslaan en afsluiten**



Om de wijzigingen op te slaan en de parameter te verlaten.

1 **Reset**



Om alle parameter weer op de fabrieksinstelling terug te brengen.

2 **Synergie**



MIG/MAG-Standaard:

Zorgt voor de keuze van het handmatig MIG (◇ Off) of synergisch MIG proces (◇ 6) door het instellen van het soort materiaal dat gelast moet worden.

Pulserend MIG/MAG:

Zorgt voor de keuze van het of synergisch MIG proces (◇ 6) door het instellen van het soort materiaal dat gelast moet worden.

Zorgt voor de keuze van het CC/CV proces.

3 **Draadsnelheid**



Maakt de regeling mogelijk van de snelheid van de draadtoevoer.

Minimaal	Maximaal	Fabrieksinstelling
0.5 m/min	22.0 m/min	-

4 **Stroom**

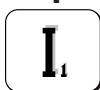

Voor het afstellen van de lasstroom.

Minimaal	Maximaal
3 A	I _{max}

5 **Stukdikte**



Maakt het mogelijk dat de dikte van het deel dat wordt gelast ingesteld wordt.
 Maakt de instelling mogelijk van het systeem doormiddel van het reguleren van het te lassen deel.

6 **Hoeklasnaad "a"**



Hiermee wordt de diepte ingesteld van de lasnaad bij een hoekaansluiting.

NL

7 Voltage - booglengte

Maakt de regeling mogelijk van de lasboog.

Maakt de regeling mogelijk van de lengte van de boog tijdens het lassen.

Hoog voltage = lange boog

Laag voltage = korte boog

Handmatiglassen

Minimaal	Maximaal	Fabrieksinstelling
5.0 V	55.5 V	5.0 V

10 Voor gas stroom tijd

Om de gasstroom vóór het ontsteken van de boog in te stellen en te regelen.

Om de toorts met gas te vullen en de werkplek voor het lassen in gereedheid te brengen.

Minimaal	Maximaal	Fabrieksinstelling
0/uit	99.9 s	0.1 s

11 Soft start

Om de draadsnelheid in te stellen en te regelen vóór u de boog ontsteekt.

Voor een ontsteking met lagere snelheid en dus soepeler en met minder spetters.

Minimaal	Maximaal	Fabrieksinstelling
10 %	100 %	50 %

12 Motor opbouw

Voor een geleidelijke overgang van de draadsnelheid bij ontsteken en lassen.

Minimaal	Maximaal	Fabrieksinstelling
0/uit	1.0 s	0/uit

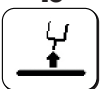
15 Burn back

Voor de regeling van de tijd dat de draad brandt waardoor vastplakken aan het einde van het lassen wordt voorkomen.

Voor de regeling van de lengte van het stuk draad buiten de toorts.

Minimaal	Maximaal	Fabrieksinstelling
-2.00	+2.00	0/syn

16 Na-gas stroomtijd

Voor het regelen van de lasstroom aan het eind van het lassen.

Minimaal	Maximaal	Fabrieksinstelling
0/uit	99.9 s	2.0 s

19 Duty cycle (dubbelpuls)

Maakt het regelen van de duty cycle in dubbelpuls mogelijk.

Minimaal	Maximaal	Fabrieksinstelling
10 %	90 %	50 %

20 Dubbel puls

Maakt het regelen van de breedte van de pulsatie mogelijk.

Minimaal	Maximaal	Fabrieksinstelling
0 %	100 %	±25 %

Minimaal	Maximaal	Fabrieksinstelling
0.5 m/min	22 m/min	2.5 m/min

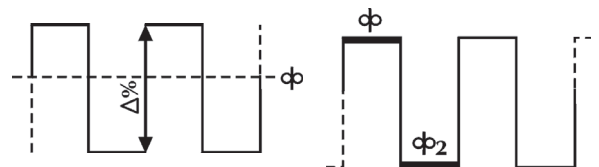
21 Puls frequentie (dubbelpuls)

Maakt het regelen van de cyclus, dat wil zeggen van de impuls herhalingscyclus.

Maakt het mogelijk de frequentie van de impuls te regelen.

Minimaal	Maximaal	Fabrieksinstelling
0.1 Hz	5.0 Hz	2.0 Hz

22 Secundaire voltage (dubbelpuls)



Maakt de regeling mogelijk van het voltage van het secundaire pulsering niveau.

Hierdoor kan grotere boog vastheid worden verkregen gedurende de verschillende fases van het pulseren.

Minimaal	Maximaal	Fabrieksinstelling
-5.0	+5.0	0/syn

23 Puls afbouwend (dubbelpuls)



Maakt de instelling van up slope tijd mogelijk tijdens het pulslassen.

Minimaal	Maximaal	Fabrieksinstelling
1 %	100 %	50 %

24 Bilevel (4T - crater filler)



Voor het regelen van de secundaire draadsnelheid bij het lassen in bilevel.

Als de lasser de knop snel indrukt en weer loslaat wordt er overgegaan op “ ϕ_2 ”.

Door de knop snel in te drukken en weer los te laten wordt er weer overgegaan op “ ϕ ” enzovoorts.

Minimaal	Maximaal	Fabrieksinstelling
1 %	200 %	0/uit

25 Aanvankelijke vermeerdering



Maakt het mogelijk de waarde van de draadtoevoer snelheid te regelen gedurende de eerste ‘krater vulling’ lasfase.

Hierdoor kan de energie aanvoer worden verhoogd wanneer dat noodzakelijk is bij dit deel van het werk in deze fase (het materiaal is nog koud), is om een gelijkmatige smelting te krijgen meer hitte nodig.

Minimaal	Maximaal	Fabrieksinstelling
20 %	200 %	120 %

26 Crater filler



Maakt het mogelijk de draadtoevoer snelheid te regelen tijdens de slot fase van het lassen.

Hierdoor kan de energie aanvoer worden verminderd wanneer dat noodzakelijk is bij dit deel van het werk in deze fase als het materiaal al heel heet is, zodoende wordt het risico op ongewilde deformaties verkleind.

Minimaal	Maximaal	Fabrieksinstelling
20 %	200 %	80 %

27 Timing aanvankelijk increment



Hiermee wordt de aanvankelijke incrementtijd ingesteld.

Voor het automatiseren van de functie voor vullen van de krater.

Minimaal	Maximaal	Fabrieksinstelling
0.1 s	99.9 s	0/uit

28 Timing krater vullen



Hiermee wordt de tijd voor vullen van de krater ingesteld.

Voor het automatiseren van de functie voor vullen van de krater.

Minimaal	Maximaal	Fabrieksinstelling
0.1 s	99.9 s	0/uit

30 Puntlassen



Zorgt ervoor de plaatselijk las procedure uit te voeren en stelt een lastijd in.

Minimaal	Maximaal	Fabrieksinstelling
0.1 s	99.9 s	0/uit

31 Pauze punt



Voor het activeren van het proces “pauze punt” en om een rusttijd tussen een las en de volgende las te bepalen.

Minimaal	Maximaal	Fabrieksinstelling
0.1 s	99.9 s	0/uit

32

Secundaire voltage (weerstand bij wisselstroom) (Bilevel MIG)

Maakt de regeling mogelijk van het voltage van het secundaire pulsering niveau.

Hierdoor kan grotere boog vastheid worden verkregen gedurende de verschillende fases van het pulseren.

Minimaal	Maximaal	Fabrieksinstelling
-5.0	+5.0	0/syn

33

Secundaire inductantie (weerstand bij wisselstroom) (Bilevel MIG)

Maakt de regeling mogelijk van het weerstand van het secundaire pulsering niveau.

Maakt het mogelijk een snellere of langzamere boog te krijgen door de bewegingen van de lasser en de natuurlijke las instabiliteit te compenseren.

Lage weerstand = terugwerkende boog (meer spetters).

Hoge weerstand = minder terugwerkende boog (minder spetters).

Minimaal	Maximaal	Fabrieksinstelling
-30	+30	0/syn

34

Aanvankelijke incrementopbouw

Om een geleidelijke overgang in te stellen van aanvankelijk increment naar lassen.

Minimaal	Maximaal	Fabrieksinstelling
0 s	10 s	0/uit

35

Rampa crater filler

Om een geleidelijke overgang in te stellen van lassen naar vullen van de krater.

Minimaal	Maximaal	Fabrieksinstelling
0 s	10 s	0/uit

202

Inductantie (weerstand bij wisselstroom)

Maakt het regelen mogelijk van de weerstand van het las circuit.

Maakt het mogelijk een snellere of langzamere boog te krijgen door de bewegingen van de lasser en de natuurlijke las instabiliteit te compenseren.

Lage weerstand = terugwerkende boog (meer spetters).

Hoge weerstand = minder terugwerkende boog (minder spetters).

Minimaal	Maximaal	Fabrieksinstelling
-30	+30	0/syn

331

Gecompenseerde gemiddelde spanning

Hiermee wordt de lasspanning ingesteld.

399

Verplaatsingsnelheid

Hiermee wordt de snelheid ingesteld waarmee het laswerk wordt uitgevoerd.

Default cm/min: referentiesnelheid voor manueel lassen.

Syn: Sinergic waarde.

Minimaal	Maximaal	Fabrieksinstelling
syn min	syn max	35 cm/min

500

Machine-instelling

Maakt het kiezen van de gewenste grafische interface mogelijk.

Maakt de toegang mogelijk tot hogere instelling niveaus.

Raadpleeg het gedeelte "Interface personificatie (Set up 500)"

Waarde	Gebruikersinterface	Waarde	Geselecteerd niveau
XE	eenvoudige modus	USER	Gebruiker
XA	Gevorderde modus	SERV	Service
XP	Professionele modus	vaBW	vaBW

551

Lock/unlock

Maakt het mogelijk de controle knoppen op het paneel te blokkeren en een bescherm code in te voeren.

Raadpleeg het gedeelte "Lock/unlock (Set up 551)".

552 Stapsgewijze aanpassing



Maakt aanpassing mogelijk van de verschillende stappen van de up-down toetsen.

Minimaal	Maximaal	Fabrieksinstelling
0/uit	10	10

601 Stapsgewijze regeling



Maakt het stapsgewijze regelen van de parameter met de persoonlijke instellingen van de lasser mogelijk. Functionaliteit bestuurd door toorts omhoog / omlaag-knop.

Minimaal	Maximaal	Fabrieksinstelling
1	Imax	1

602 Externe parameter CH1, CH2, CH3, CH4



Maakt de besturing mogelijk van de externe parameter 1, 2, 3, 4 (minimale waarde, maximale waarde, waarde ingesteld door de fabriek, geselecteerde parameter).

Raadpleeg het gedeelte "Beheer van externe controle (Set up 602)".

606 U/D toorts



Maakt de besturing mogelijk van de externe parameter (U/D).

Waarde	Fabrieksinstelling	Callback-functie
0/uit	-	uit
1/11	X	Stroom
	-	Programma ontsluiten

705 Afstelling weerstand circuit



Voor het afstellen van de apparatuur.

Raadpleeg het gedeelte "Afstelling weerstand circuit (set up 705)".

751 Stroom aflezen



Toont de werkelijke waarde van de lasstroom.

752 Voltage aflezen



Toont de werkelijke waarde van het las voltage.

755 Gasstroom aflezen (WFR)



Maakt het tonen van de werkelijke waarde van de gasstroom mogelijk.

757 Draadsnelheid aflezen



Encoder motor 1 inlezen.

758 Bewegingsnelheid van de robot



Maakt het mogelijk dat de bewegingsnelheid van de arm van een robot of van een automatisch apparaat wordt getoond.

760 Stroom aflezen (motor 1)



Toont de werkelijke waarde van de motorstroom (motor 1).

761 Draadsnelheid aflezen



Encoder motor 2 inlezen.

NL

762 Stroom aflezen (motor 2)



Toont de werkelijke waarde van de motorstroom (motor 2).

763 Draadsnelheid aflezen



Inlezen van de werkelijke draadaanvoer.

764 Koelvloeistofstroom inlezen



Toont de waarde van de koelvloeistofstroom.

765 Temperatuur koelvloeistof aflezen



Toont de werkelijke waarde van de temperatuur koelvloeistof.

768 Meting warmtetoevoer HI



Hiermee kan de waarde van de warmtetoevoermeting tijdens het lassen worden afgelezen.

801 Bewaken van limieten





Maakt het instellen mogelijk van de waarschuwingsgrens en van de bewaking van de limieten.
 Maakt het mogelijk dat het lasproces wordt gecontroleerd door het instellen van waarschuwinglimieten en bewakingslimieten voor de voornaamste meetbare parameters.
 Maakt een accurate controle mogelijk van de diverse las fases.
 Raadpleeg het gedeelte "Bewaken van limieten (Set up 801)".

5.2 Specifieke gebruiksprocedures van de parameters

5.2.1 7 segmenten display personalisatie

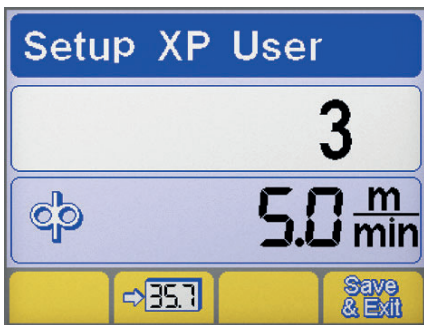
Hiermee kan de waarde van een parameter constant op het 7-segmenten-display worden weergegeven.



- ▶ Begin in set-up door de decoder knop minstens 5 seconden in te drukken.
- ▶ Selecteer de gewenste parameter door de decoder.
- ▶ Sla de geselecteerde parameter op in het 7 segmenten display door de knop in te drukken .
- ▶ Sla het op en verlaat het huidige scherm door de knop in te drukken .

NL

5.2.2 Interface personalisatie (Set up 500)

Maakt het mogelijk dat de parameters worden aangepast op het hoofdmenu.

500 Machine-instelling



Maakt het kiezen van de gewenste grafische interface mogelijk.

Waarde	Gebruikersinterface	
XE	eenvoudige modus	
XA	Gevorderde modus	
XP	Professionele modus	

MODUS XE



TIG

Las parameters	
Functies	

MIG/MAG

Las parameters	
Functies	

MODUS XA

MMA

Las parameters	
Functies	

TIG

Las parameters	
Functies	

MIG/MAG

Las parameters	
Functies	

MODUS XP

MMA

Las parameters	
Functies	

TIG

Las parameters	
Functies	

MIG/MAG

Las parameters	
Functies	

NL

5.2.3 Lock/unlock (Set up 551)

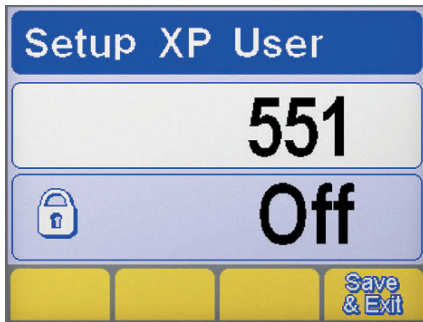

Maakt het mogelijk de controle knoppen op het paneel te blokkeren en een bescherm code in te voeren.

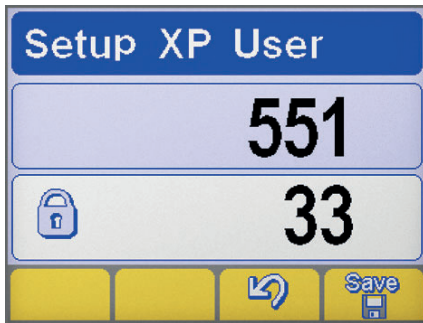

Selectie parameter

- ▶ Begin in set-up door de decoder knop minstens 5 seconden in te drukken.
- ▶ Selecteer de gewenste parameter (551).
- ▶ Activeer de regeling van de geselecteerde parameter door de decoder knop in te drukken.





- ▶ Stel een numerieke code (paswoord) in door de decoder te draaien.
- ▶ Druk op de encoder-toets om de bewerking te bevestigen.
- ▶ Bevestig de handeling door de knop in te drukken .
- ▶ Om de wijziging op te slaan drukt u op de knop: .

Functies van het paneel

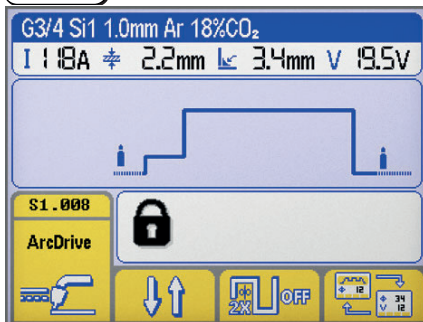

Het uitvoeren van elke handeling op een afgesloten controle paneel laat een speciaal scherm verschijnen.



- ▶ Tijdelijke toegang tot de functies op het paneel (5 minuten) door de decoder te draaien en het juiste paswoord in te voeren.
- ▶ Druk op de encoder-toets om de bewerking te bevestigen.
- ▶ Open het controle paneel definitief door in de set-up te beginnen (volg de instructies die hierboven gegeven zijn) en breng parameter 551 terug naar 'af'.
- ▶ Druk op de encoder-toets om de bewerking te bevestigen.
- ▶ Om de wijziging op te slaan drukt u op de knop: .

NL

5.2.4 Beheer van externe controle (Set up 602)

Maakt de besturing mogelijk van de externe parameter 2 (minimale waarde, maximale waarde, waarde ingesteld door de fabriek, geselecteerde parameter).

Selectie parameter



- ▶ Begin in set-up door de decoder knop minstens 5 seconden in te drukken.
- ▶ Selecteer de gewenste parameter (602).
- ▶ Begin in het "Externe controle beheer" scherm door de decoder knop in te drukken.

Beheer van externe controle

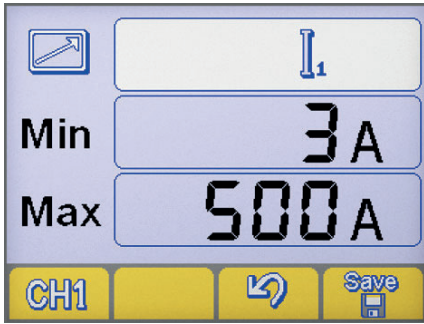

- ▶ Selecteer de gewenste RC afstandsbediening uitgang (CH1, CH2, CH3, CH4) door de knop in te drukken.
- ▶ Selecteer de gewenste parameter (Min-Max - parameter) door de knop van de decoder in te drukken.
- ▶ Pas de gewenste parameter aan (Min-Max - parameter) door de decoder te draaien.
- ▶ Om de wijziging op te slaan drukt u op de knop:
- ▶ Bevestig de handeling door de knop in te drukken

5.2.5 Afstelling weerstand circuit (set up 705)

Hiermee kan de generator worden afgesteld op de weerstand van het huidige lascircuit.

Selectie parameter

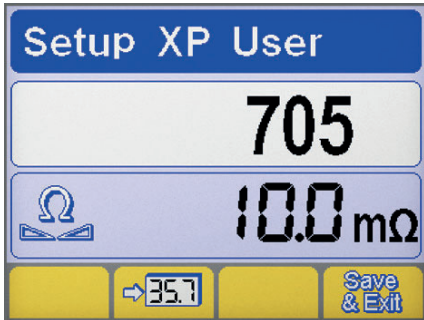

- ▶ Begin in set-up door de decoder knop minstens 5 seconden in te drukken.
- ▶ Selecteer de gewenste parameter (705).
- ▶ Activeer de regeling van de geselecteerde parameter door de decoder knop in te drukken.
- ▶ Sluit de generator aan op het lascircuit (bank of werkstuk).
- ▶ Verwijder de dop om de mondstukhouder van de toorts bloot te leggen. (MIG/MAG)

Afstelling

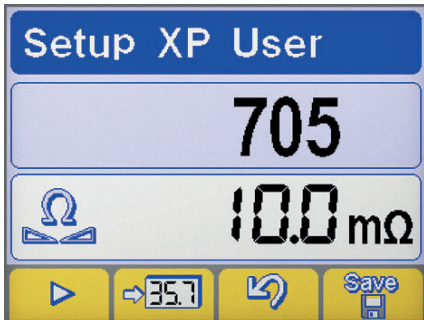

- ▶ Breng draadpunt en lasstuk elektrisch met elkaar in contact. (MIG/MAG)
- ▶ Druk op de knop om de procedure te starten.
- ▶ Houd het contact ten minste een seconde aan.
- ▶ De op het display weergegeven waarde wordt bijgewerkt nadat de afstelling is uitgevoerd.
- ▶ Bevestig de handeling door de knop in te drukken
- ▶ Bevestig de handeling door de knop in te drukken
- ▶ Om de wijziging op te slaan en de instelling te verlaten drukt u op de knop:

5.2.6 Bewaken van limieten (Set up 801)

Maakt het instellen mogelijk van de waarschuwingsgrenzen en van de bewaking van de limieten.

Maakt het mogelijk dat het lasproces wordt gecontroleerd door het instellen van waarschuwingslimieten en bewakingslimieten voor de voornaamste meetbare parameters.

Maakt een accurate controle mogelijk van de diverse las fases.

Waarschuwingsgrenzen			Bewaken van limieten		
Lasstroom			lasspanning		
Gasstroom aflezen			Bewegingsnelheid van de robot		
Stroom aflezen (motor 1)			Stroom aflezen (motor 2)		
Koelvloeistofstroom inlezen			Draadsnelheid aflezen		
Temperatuur koelvloeistof aflezen					

Selectie parameter

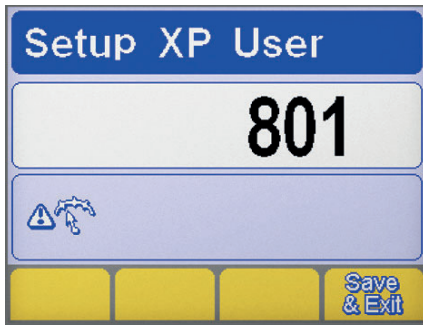

- ▶ Begin in set-up door de decoder knop minstens 5 seconden in te drukken.
- ▶ Selecteer de gewenste parameter (801).
- ▶ Begin in het Bewaak de limieten scherm door de decoder knop in te drukken.

Selectie van de parameter

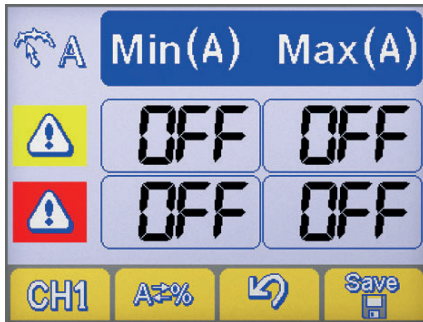

- ▶ Selecteer de gewenste parameter door knop in te drukken set **CH1**.
- ▶ Selecteer de instel methode van de bewakingslimieten door de knop in te drukken **A=%**.

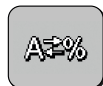

Machine-instelling



Absolute waarde



Waarde percentage

Instelling waarschuwingsgrenzen

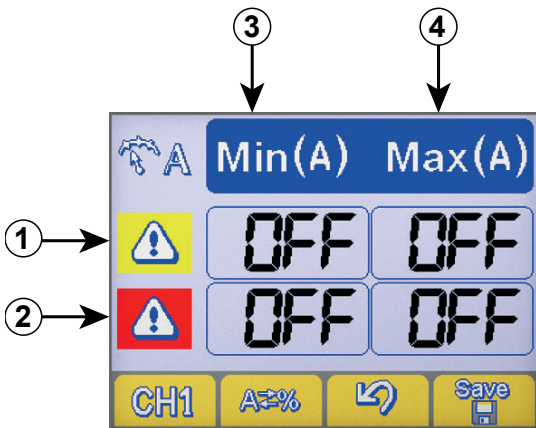

- ① Waarschuwinglimieten lijn
- ② Alarm limieten lijn
- ③ Minimale niveaus kollom
- ④ Maximale niveaus kollom

- ▶ Selecteer de gewenste box door de decoder sleutel in te drukken (de geselecteerde box wordt getoond in spiegelbeeld).
- ▶ Pas het niveau van de geselecteerde limiet door de decoder te draaien.
- ▶ Om de wijziging op te slaan drukt u op de knop: **Save**.



Wanneer u één van de waarschuwingslimieten overschrijdt verschijnt er een visueel signaal op het controle paneel.



Wanneer u één van de alarm limieten overschrijd verschijnt er een visueel signaal op het controle paneel en volgt de onmiddellijke blokkade van de las handeling.



Het is mogelijk om het begin en het einde in te stellen van de las filters om foutieve signalen te voorkomen gedurende het aansteken en uitgaan van de boog (raadpleeg het gedeelte Set-up - Parameters 802-803-804).

6. ONDERHOUD



De normale onderhoud werkzaamheden moeten worden uitgevoerd volgens de richtlijnen die de fabrikant heeft verstrekt. Als de machine is ingeschakeld moeten alle ingangspunten en panelen zijn gesloten. De installatie mag op geen enkele manier worden gewijzigd. Voorkom ophoping van metaalstof bij of op het koelrooster.



Iedere onderhoud beurt dient te worden gedaan door gekwalificeerd personeel. Bij reparatie of vervanging van een onderdeel in de machine door onbevoegd personeel vervalt de garantie. De reparatie of vervanging van een onderdeel in de machine dient te worden gedaan door gekwalificeerd personeel.



Schakel de stroomtoevoer altijd uit voor u onderhoud pleegt.

6.1 Controleer de stroombron regelmatig als volgt

6.1.1 Zařizení



Reinig de machine aan de binnenkant door hem uit te blazen en af te borstelen met een zachte borstel. Controleer de elektrische aansluitingen en de kabels.

6.1.2 Voor het onderhoud of de vervanging van de toorts, elektrodetang en of aardkabels:



Controleer de temperatuur van het onderdelen en overtuig u ervan dat ze niet te heet zijn.



Draag altijd handschoenen die aan de veiligheidsvoorschriften voldoen.



Gebruik geschikte sleutels en gereedschap.

6.2 Odpovědnost



Als geen regelmatig onderhoud wordt uitgevoerd, vervalt de garantie en wordt de fabrikant van alle aansprakelijkheid ontheven. De fabrikant wijst ieder verantwoordelijkheid af wanneer de gebruiker zich niet houdt aan de volgende richtlijnen. In geval van twijfel of problemen aarzel niet contact op te nemen met uw leverancier.

7. ALARM CODES



ALARM

De tussenkomst van een alarm of de overschrijding van een kritieke waarschuwingsgrens veroorzaakt een visueel signaal op het bedieningspaneel en de onmiddellijke stopzetting van de laswerkzaamheden.



























Let op!

De tussenkomst van een alarm of de overschrijding van een kritieke waarschuwingsgrens veroorzaakt een visueel signaal op het bedieningspaneel en de onmiddellijke stopzetting van de laswerkzaamheden.

Hieronder volgt een lijst van alle alarmen en waarschuwingsgrenzen met betrekking tot het systeem.

E01	Overtemperatuur		E02	Overtemperatuur	
E03	Overtemperatuur		E05	Overstroom	
E06	Overstroom vermogensmodule (Boost)		E07	Storing voedingssysteem van draadtoevoermotor	
E08	Moteur bloqué		E10	Overstroom vermogensmodule (Inverter)	

 E11 Fout in systeemconfiguratie 	 E12 Communicatiefout (WF - DSP) 
 E13 Communicatiefout 	 E14 Programma niet geldig 
 E15 Programma niet geldig 	 E16 Communicatiefout (RI) (Automatisering en robot besturing) 
 E17 Communicatiefout (μ P-DSP) 	 E18 Programma niet geldig 
 E19 Fout in systeemconfiguratie 	 E20 Defect geheugen 
 E21 Gegevensverlies 	 E22 Communicatiefout (DSP) 
 E29 Incompatibele metingen 	 E30 Communicatiefout (H.F.) 
 E32 Gegevensverlies 	 E38 Onderspanning 
 E39 Storing systeemvoeding 	 E40 Storing systeemvoeding 
 E43 Geen koelvloeistof 	 E48 Geen draad (Automatisering en robot besturing) 
 E49 Noodschakelaar (Automatisering en robot besturing) 	 E50 Draad vastgeplakt (Automatisering en robot besturing) 
 E51 Instellingen niet ondersteund (Automatisering en robot besturing) 	 E52 Antistoot (Automatisering en robot besturing) 
 E53 Fout externe flowschakelaar (Automatisering en robot besturing) 	 E54 Stroomniveau overschreden (Onderste grens) 
 E55 Stroomniveau overschreden (Bovenste grens) 	 E56 Spanningsniveau overschreden (Onderste grens) 
 E57 Spanningsniveau overschreden (Bovenste grens) 	 E60 Snelheidslimiet overschreden (Onderste grens) 
 E61 Snelheidslimiet overschreden (Bovenste grens) 	 E62 Stroomniveau overschreden (Onderste grens) 
 E63 Stroomniveau overschreden (Bovenste grens) 	 E64 Spanningsniveau overschreden (Onderste grens) 

 E65	Spanningsniveau overschreden (Bovenste grens)		 E68	Snelheidslimiet overschreden (Onderste grens)	
 E69	Snelheidslimiet overschreden (Bovenste grens)		 E70	Ingestelde waarschuwingsgrenzen niet compatibel	
 E71	Overtemperatuur koelvloeistof		 E72	Overstroom motor push-pull	
 E73	Draadsnelheidslimiet overschreden (speed meter)		 E74	Stroomniveau motor 1 overschreden	
 E75	Stroomniveau motor 2 overschreden		 E76	Stromingsniveau koelvloeistof overschreden	
 E77	Temperatuurniveau koelvloeistof		 E78	Onderhoud actief (Automatisering en robot besturing)	

8. MEEST VOORKOMENDE VRAGEN EN OPLOSSINGEN

De machine werkt niet (groene LED is uit)

Vraag

- » Geen stroom op het stopcontact.
- » Stopcontact of kabel defect.
- » Zekering doorgebrand.
- » Aan/uit schakelaar werkt niet.
- » De verbinding tussen de draadtoevoer eenheid en de stroombron is onjuist of defect.
- » Elektronica defect.

Oplossing

- » Controleer en indien nodig repareer de stroomtoevoer.
- » Laat dit uitvoeren door bevoegd personeel
- » Vervang het defecte onderdeel.
- » Neem contact op met uw leverancier om de machine te laten repareren.
- » Vervang het defecte onderdeel.
- » Vervang het defecte onderdeel.
- » Neem contact op met uw leverancier om de machine te laten repareren.
- » Controleer of de verschillende onderdelen van het systeem goed zijn aangesloten.
- » Neem contact op met uw leverancier om de machine te laten repareren.

Geen uitgaand vermogen (de machine last niet)

Vraag

- » Toortsknop defect
- » De machine raakt oververhit (thermisch alarm - gele LED aan)
- » Zijpaneel open of deurschakelaar defect.
- » Aard aansluiting niet goed.
- » Stroomaansluiting niet bereikbaar (gele led aan)
- » Elektronica defect.

Oplossing

- » Vervang het defecte onderdeel.
- » Neem contact op met uw leverancier om de machine te laten repareren.
- » Wacht tot de machine is afgekoeld zonder hem uit te schakelen (gele LED uit).
- » Voor de veiligheid van de lasser moet het zijpaneel tijdens het lassen gesloten zijn.
- » Vervang het defecte onderdeel.
- » Neem contact op met uw leverancier om de machine te laten repareren.
- » Aardt de machine goed.
- » Raadpleeg de paragraaf "Installeren".
- » Breng de stroomaansluiting binnen het bereik van de stroombron.
- » Sluit het systeem goed aan.
- » Raadpleeg de paragraaf "Aansluitingen".
- » Neem contact op met uw leverancier om de machine te laten repareren.

Onjuist uitgaand vermogen

Vraag

- » Verkeerde keuze van las proces of defecte keuzeschakelaar.

- » De parameters of de functies zijn verkeerd ingesteld.

- » Potentiometer/encoder voor het regelen van de lasstroom defect.

- » Netspanning buiten bereik.

- » Er ontbreekt een fase.

- » Elektronica defect.

Oplossing

- » Kies het goede las proces.
- » Vervang het defecte onderdeel.
- » Neem contact op met uw leverancier om de machine te laten repareren.

- » Voer een systeemreset uit en stel de lasparameters opnieuw in.

- » Vervang het defecte onderdeel.
- » Neem contact op met uw leverancier om de machine te laten repareren.

- » Sluit het systeem goed aan.
- » Raadpleeg de paragraaf "Aansluitingen".

- » Sluit het systeem goed aan.
- » Raadpleeg de paragraaf "Aansluitingen".

- » Neem contact op met uw leverancier om de machine te laten repareren.

Draadtoevoer blokkeert

Vraag

- » Toortsknop defect

- » Kapotte of versleten rollen.

- » Draadaanvoer onderdeel kapot.

- » Toorts liner beschadigd.

- » Geen stroom op de draadtoevoer unit.

- » Draad op de spoel in de knoop.

- » Toortsmondstuk gesmolten(draad vastgeplakt).

Oplossing

- » Vervang het defecte onderdeel.
- » Neem contact op met uw leverancier om de machine te laten repareren.

- » Vervang de rollen.

- » Vervang het defecte onderdeel.
- » Neem contact op met uw leverancier om de machine te laten repareren.

- » Vervang het defecte onderdeel.
- » Neem contact op met uw leverancier om de machine te laten repareren.

- » Controleer de aansluiting op de stroombron.
- » Raadpleeg de paragraaf "Aansluitingen".
- » Neem contact op met uw leverancier om de machine te laten repareren.

- » Haal de draad uit de knoop of verwissel de spoel.

- » Vervang het defecte onderdeel.

Onregelmatige draadtoevoer

Vraag

- » Toortsknop defect

- » Kapotte of versleten rollen.

- » Draadaanvoer onderdeel kapot.

- » Toorts liner beschadigd.

- » Haspelkoppeling of rolblokkering onderdeel niet goed afgesteld.

Oplossing

- » Vervang het defecte onderdeel.
- » Neem contact op met uw leverancier om de machine te laten repareren.

- » Vervang de rollen.

- » Vervang het defecte onderdeel.
- » Neem contact op met uw leverancier om de machine te laten repareren.

- » Vervang het defecte onderdeel.
- » Neem contact op met uw leverancier om de machine te laten repareren.

- » Koppeling losmaken.
- » Druk op de rollen verhogen.

Boog instabiel

Vraag

- » Onvoldoende bescherm gas.

Oplossing

- » Pas de gasstroom aan.
- » Controleer of de gasverdeler en het gasmondstuk in goede staat zijn.

» Aanwezigheid van vocht in het gas.

» Gebruik altijd kwaliteitsproducten en materialen.

» Controleer of de gastoevoer in goede staat is.

» Las parameters niet correct.

» Voer een grondige controle uit van de lasapparatuur.

» Neem contact op met uw leverancier om de machine te laten repareren.

Teveel spetteren

Vraag

» De booglente niet correct.

Oplossing

» Verminder de afstand tussen de elektrode en het werkstuk.

» Verminder het voltage om te lassen.

» Las parameters niet correct.

» Verlaag de lasstroom.

» Onvoldoende bescherm gas.

» Pas de gasstroom aan.

» Controleer of de gasverdeler en het gasmondstuk in goede staat zijn.

» Lasboog niet regelmatig.

» Verhoog de inductie waarde.

» Gebruik een hogere inductie aansluiting.

» Wijze van lassen niet correct.

» Verminder de lashoek van de toorts.

Onvoldoende penetratie

Vraag

» Wijze van lassen niet correct.

Oplossing

» Voortgangsnelheid lassen verlagen.

» Las parameters niet correct.

» Verhoog de las stroom.

» Elektrode niet correct.

» Gebruik een elektrode met een kleinere diameter.

» Onjuiste voorbereiding van de werkstukken.

» Vergroot de lasopening.

» Aard aansluiting niet goed.

» Aardt de machine goed.

» Raadpleeg de paragraaf "Installeren".

» Te lassen werkstukken zijn te groot.

» Verhoog de las stroom.

Slakken

Vraag

» Slakken niet geheel verwijderd.

Oplossing

» Maak de stukken grondig schoon alvorens ze te lassen.

» Diameter van de elektrode te groot.

» Gebruik een elektrode met een kleinere diameter.

» Onjuiste voorbereiding van de werkstukken.

» Vergroot de lasopening.

» Wijze van lassen niet correct.

» Verminder de afstand tussen de elektrode en het werkstuk.

» Beweeg regelmatig tijdens het lassen.

Insluiten van de wolfram

Vraag

» Las parameters niet correct.

Oplossing

» Verlaag de lasstroom.

» Gebruik een elektrode met grotere diameter.

» Elektrode niet correct.

» Gebruik altijd kwaliteitsproducten en materialen.

» Elektrode goed slijpen.

» Wijze van lassen niet correct.

» Contact tussen elektrode en lasbad vermijden.

Blazen

Vraag

» Onvoldoende bescherm gas.

Oplossing

» Pas de gasstroom aan.

» Controleer of de gasverdeler en het gasmondstuk in goede staat zijn.

Plakken

Vraag

» De booglente niet correct.

Oplossing

» Vergroot de afstand tussen de elektrode en het werkstuk.

» Verhoog het las voltage.

» Las parameters niet correct.

» Verhoog de las stroom.

» Verhoog het las voltage.

- » Wijze van lassen niet correct.
- » Te lassen werkstukken zijn te groot.
- » Lasboog niet regelmatig.

- » Toorts schuiner houden.
- » Verhoog de las stroom.
- » Verhoog de inductie waarde.
- » Gebruik een hogere inductie aansluiting.

Inkartelingen

Vraag

- » Las parameters niet correct.
- » De booglente niet correct.
- » Wijze van lassen niet correct.
- » Onvoldoende bescherm gas.

Oplossing

- » Verlaag de lasstroom.
- » Gebruik een elektrode met een kleinere diameter.
- » Verminder de afstand tussen de elektrode en het werkstuk.
- » Verminder het voltage om te lassen.
- » Verlaag de laterale oscillatiesnelheid bij het vullen.
- » Voortgangsnelheid lassen verlagen.
- » Gebruik voor het lassen materiaal geschikt gas.

Oxidatie

Vraag

- » Onvoldoende bescherm gas.

Oplossing

- » Pas de gasstroom aan.
- » Controleer of de gasverdeler en het gasmondstuk in goede staat zijn.

Poreusheid

Vraag

- » Smeer, lak, roest of stof op het las werkstuk.
- » Smeer, lak, roest of stof op het lasmateriaal.
- » Vocht in het lasmateriaal.
- » De booglente niet correct.
- » Aanwezigheid van vocht in het gas.
- » Onvoldoende bescherm gas.
- » Het lasbad stolt te snel.

Oplossing

- » Maak de stukken grondig schoon alvorens ze te lassen.
- » Gebruik altijd kwaliteitsproducten en materialen.
- » Houdt het lasmateriaal altijd in perfecte staat.
- » Gebruik altijd kwaliteitsproducten en materialen.
- » Houdt het lasmateriaal altijd in perfecte staat.
- » Verminder de afstand tussen de elektrode en het werkstuk.
- » Verminder het voltage om te lassen.
- » Gebruik altijd kwaliteitsproducten en materialen.
- » Controleer of de gastoevoer in goede staat is.
- » Pas de gasstroom aan.
- » Controleer of de gasverdeler en het gasmondstuk in goede staat zijn.
- » Voortgangsnelheid lassen verlagen.
- » Verwarm de te lassen delen voor.
- » Verhoog de las stroom.

Warmte scheuren

Vraag

- » Las parameters niet correct.
- » Smeer, lak, roest of stof op het las werkstuk.
- » Smeer, lak, roest of stof op het lasmateriaal.
- » Wijze van lassen niet correct.
- » Werkstukken met verschillende eigenschappen.

Oplossing

- » Verlaag de lasstroom.
- » Gebruik een elektrode met een kleinere diameter.
- » Maak de stukken grondig schoon alvorens ze te lassen.
- » Gebruik altijd kwaliteitsproducten en materialen.
- » Houdt het lasmateriaal altijd in perfecte staat.
- » Volg de juiste werkmethode voor het betreffende las werk.
- » Eerst bufferlaag aanbrengen.

Koude scheuren

Vraag

- » Vocht in het lasmateriaal.
- » Speciale meetkundige vorm van het te lassen werkstuk.

Oplossing

- » Gebruik altijd kwaliteitsproducten en materialen.
- » Houdt het lasmateriaal altijd in perfecte staat.
- » Verwarm de te lassen delen voor.
- » Het werkstuk naverwarmen.
- » Volg de juiste werkmethode voor het betreffende las werk.

9. ALGEMENE INFORMATIE OVER LASSEN

9.1 Handleiding lassen met beklede elektroden (MMA)

Vorbereiden van de lasnaden

Om goed lasresultaat te behalen adviseren wij u altijd te werken met schone materialen, zonder oxidatie, roest of andere verontreinigingen.

Keuze van de elektrode

De diameter van de elektrode die u moet gebruiken hangt af van de dikte van het materiaal, van de positie, het type van de lasnaad en het type voorbereiding van het werkstuk. Elektrode met een grote diameter hebben van zelf sprekend zeer hoge lasstroom nodig met als gevolg grote warmtetoever tijdens het lasproces.

Type bekleding	Eigenschappen	Gebruik
Rutiel	eenvoudig in gebruik	in alle posities
Acid	Vlugge smelting	vlak
Basisch	Mechanische eigenschappen	in alle posities

Keuze van de lasstroom

Het bereik van de lasstroom van een bepaalde elektrode staat vermeld op de verpakking.

Starten en aanhouden van de boog

De lasboog wordt gestart door met punt van de elektrode het werkstuk, dat met een aardekabel aangesloten is, aan te tikken. Als de boog eenmaal is gestart trekt u de elektrode snel terug tot de normale las afstand. Meestal wordt om de boog sneller te laten aanslaan een stroomstoot (Hot Start) gegeven die de punt van de elektrode snel zal verwarmen. Wanneer de boog eenmaal gevormd is begint het middelste deel van de elektrode te smelten waardoor kleine druppels ontstaan die het lasbad vormen op het werkstuk. Het buitenste van de elektrode, de bekleding, wordt ontbonden en het gas dat daarbij vrijkomt dient als bescherming voor de las waardoor de goede kwaliteit van de las wordt gewaarborgd. Om te voorkomen dat op het gesmolten materiaal de lasvlam dooft door kortsluiting en de elektrode aan het lasbad plakt, wordt de lasstroom tijdelijk verhoogd (Arc Force). Wanneer de elektrode aan het werkstuk plakt kunt u het beste de kortsluitstroom tot minimale sterkte beperken (antisticking).

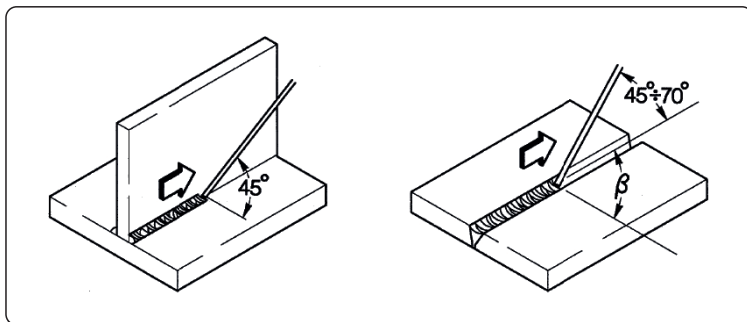

Het lassen

De laspositie varieert afhankelijk van het aantal doorgangen; gewoonlijk wordt de lasnaad gevormd door de elektrode heen en weer te bewegen op zo'n manier dat er geen ophoping van materiaal in het midden ontstaat.

Verwijderen van de slakken

Bij het lassen met beklede elektroden moeten na iedere lasdoorgang de slakken worden verwijderd. U kunt de slak verwijderen met een kleine hamer of indien brokkelig met een borstel.

9.2 TIG-Lassen met onderbroken vlamboog

Beschrijving

Het principe van het Tig (Tungsten Inert Gas) lassen is gebaseerd op een elektrische boog die ontstaat tussen een niet verbruikbare elektrode (zuiver wolfram(tungsten) of een legering met een smelttemperatuur van ongeveer 3370°C) en het werkstuk; een edelgas (argon) beschermt het smeltbad tegen oxideren. Om gevaarlijke wolframinsluitingen in de lasnaad moet de elektrode nooit in aanraking komen met het werkstuk, daarom wordt er door middel van een H.F.stroombron voor ontlading gezorgd waardoor de elektrische boog op afstand ontstoken kan worden. De elektrische vonk zorgt er dus voor dat de boog ontstaat zonder enig contact tussen de elektrode en het werkstuk. Er is nog een start mogelijkheid met beperkte wolfram opname; de lift start, hier voor is geen hoog frequent nodig, maar slechts een korte stroomstoot op lage snelheid tussen de elektrode en het werkstuk. Als de elektrode wordt opgetild ontstaat de boog en de stroom wordt opgevoerd tot de juiste waarde om te lassen. Om de kwaliteit van de lasrups te verhogen is het belangrijk de daling van de stroom te controleren en het gas na het doven nog enige seconden door te laten stromen in het lasbad. In veel werkomstandigheden is het nuttig als er bij het werk van twee lasstromen gebruik gemaakt kan worden en om eenvoudig van de ene naar de andere te kunnen omschakelen (BILEVEL).

Polariteit van de las

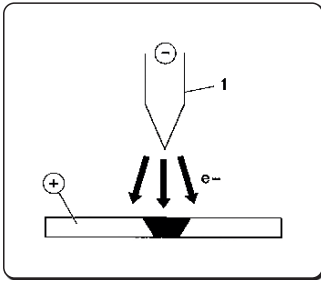

D.C.S.P.(Direct Current Straight Polarity)

Dit is de meest gebruikte polariteit. Deze laat een minimaal verbruik toe van de elektrode (1) omdat 70% van de warmte wordt geconcentreerd op de anode (werkstuk). Hiermee kunnen smalle en diepen lassen gemaakt worden, met grote lassnelheid en lage warmte toevoer.

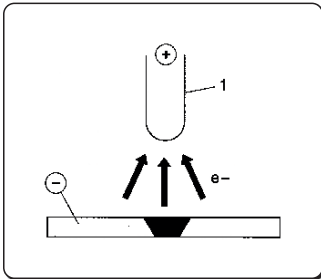

D.C.S.P.- (Direct Current Reverse Polarity)

Deze polariteit wordt gebruikt bij het lassen van legeringen die met een laag oxidatie waarvan het smeltpunt hoger ligt dan van het metaal. Hoge lasstromen zijn echter niet mogelijk omdat daardoor de elektrode bijzonder hard zou slijten.

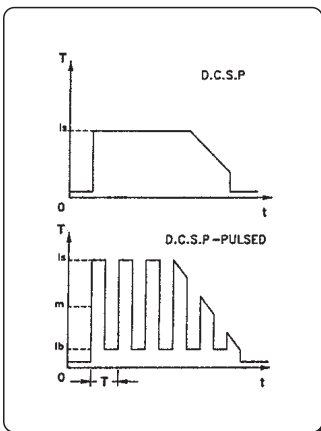

D.C.S.P. Pulseren (Direct Current Straight Polarity Pulsed)

Door het gebruik van een pulserende gelijkstroom is bij bijzondere werkomstandigheden een betere controle van het lasbad mogelijk. Het lasbad wordt gevormd door de piekpulsen (Ip), terwijl de basisstroom (Ib) door laat branden; dit maakt het lassen van dunne werkstukken met minder vervormingen gemakkelijker, betere vormfactor en dus minder risico op kerven en gasinsluitingen. Naar mate de frequentie stijgt (MF) wordt de boog smaller, meer geconcentreerd en stabiel, en dus een nog betere kwaliteit las bij het lassen van dunne werkstukken.

TIG lassen van staal

De Tig procedure is heel effectief voor het lassen van zowel koolstofstaal als gelegeerd staal, voor de eerste passage over pijpen evenals bij lassen die een optimaal esthetisch aspect moeten hebben. Hiervoor is een directe polariteit noodzakelijk.(D.C.S.P.).

Vorbereiden van de lasnaden

Het is noodzakelijk de lasnaden zorgvuldig voor te bereiden en schoon te maken.

Keuze en voorbereiding van de elektrode

Het gebruik van thorium wolframelektroden (2% thorium, rood gekleurd) of als alternatief cerium of lanthanum elektroden met de volgende diameters:

Ø elektrode	Stroomgamma
1.0 mm	15÷75 A
1.6 mm	60÷150 A
2.4 mm	130÷240 A

De elektrode moet geslepen worden zoals aangegeven is in her schema.

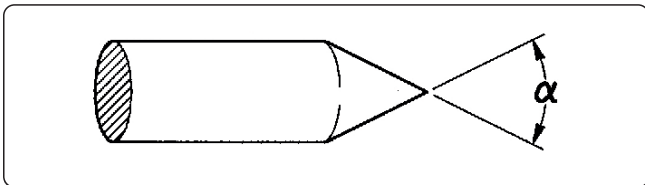

α°	Stroomgamma
30	0÷30 A
60÷90	30÷120 A
90÷120	120÷250 A

Toevoegmateriaal

De lasstaven moeten de zelfde eigenschappen hebben als het basismateriaal. Het gebruik van stroken die van het basismateriaal afkomstig zijn is af te raden omdat deze allerlei onzuiverheden kunnen bevatten die een negatief effect kunnen hebben op de laskwaliteit.

NL

Beschermgas

Hiervoor wordt bijna altijd zuivere argon (99,99%) gebruikt.

Lasstroom	Ø elektrode	Gasmondstuk n°	Gasmondstuk	Argon stroom
30 A	0÷30 mm	4/5	6/8.0 mm	5-6 l/min
60÷90 A	30÷120 mm	4/5/6	6.5/8.0/9.5 mm	6-7 l/min
90÷120 A	120÷250 mm	6/7	9.5/11.0 mm	7-8 l/min

TIG lassen van koper

Tig lassen is een procédé met grote warmte concentratie, het is bijzonder geschikt voor het lassen van materialen met hoge warmtegeleiding zoals koper.

Bij het TIG lassen van koper volgt u dezelfde procedure als voor het TIG lassen van staal of specifieke instructies.

9.3 Lassen met constante draadtoevoer (MIG/MAG)

Inleiding

Een MIG systeem bestaat uit een gelijkstroom stroombron, een toevoereenheid, een draadspool een toorts en gas.

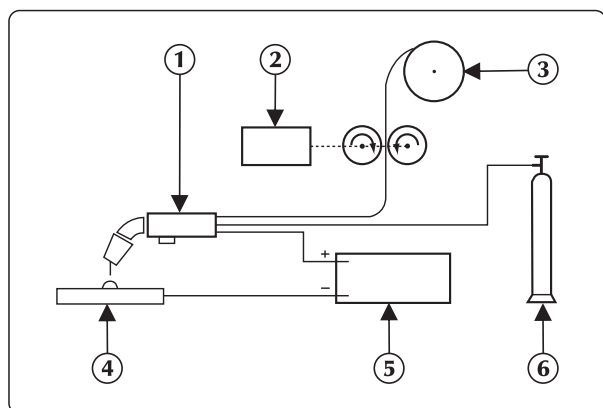

De stroom wordt op de boog overgebracht door middel van een afsmeltende elektrode (draad met positieve polariteit); in deze procedure wordt het gesmolten metaal door een boog overgebracht op het te lassen werkstuk.

De stroom wordt op de boog overgebracht via de smeltelektrode (draad met positieve polariteit);

In dit procedé wordt het gesmolten metaal via de boog op het te lassen werkstuk overgebracht.

De draadtoevoer is nodig om de gesmolten toevoegdraad tijdens het lassen aan te vullen.

Werkmethoden

Bij het Mig lassen onder beschermend gas zijn twee overdrachtssystemen nodig die gerangschikt kunnen worden naar de manier waarop metaal wordt overgebracht van de elektrode naar het werkstuk.

De eerste methode is "KORTSLUIT BOOGLASSEN" (Short-Arc), en hierbij komt de elektriciteit direct in aanraking met het lasbad, waardoor een kortsluiting veroorzaakt wordt waarbij de draad als zekering optreedt en de boog onderbroken wordt. Vervolgens gaat de boog weer branden en wordt de cyclus herhaald.

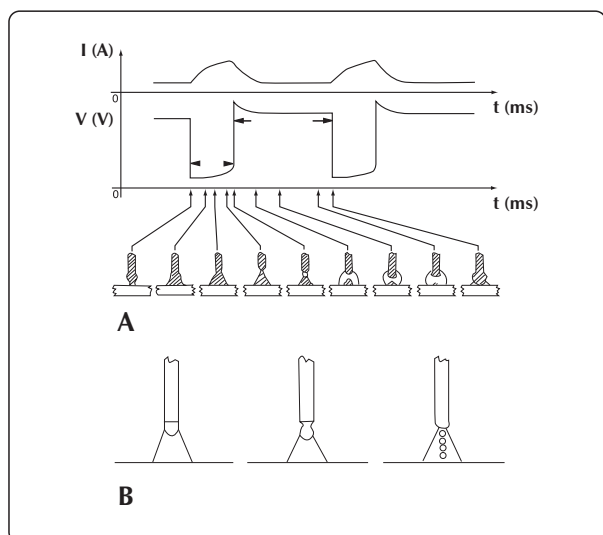

SHORT cyclus en SPRAY ARC lassen

Een andere methode voor de overdracht van de druppels vindt plaats bij het zogenaamde "SPROEI BOOGLASSEN" (Spray-Arc). Hierbij komen de druppels van de elektrode los en komen pas later in het smeltbad terecht.

NL

Las parameters



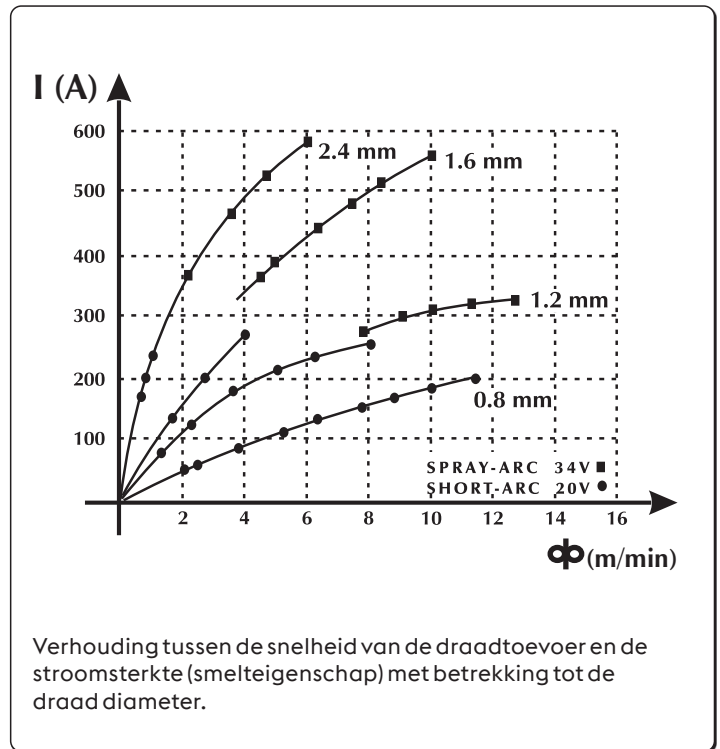
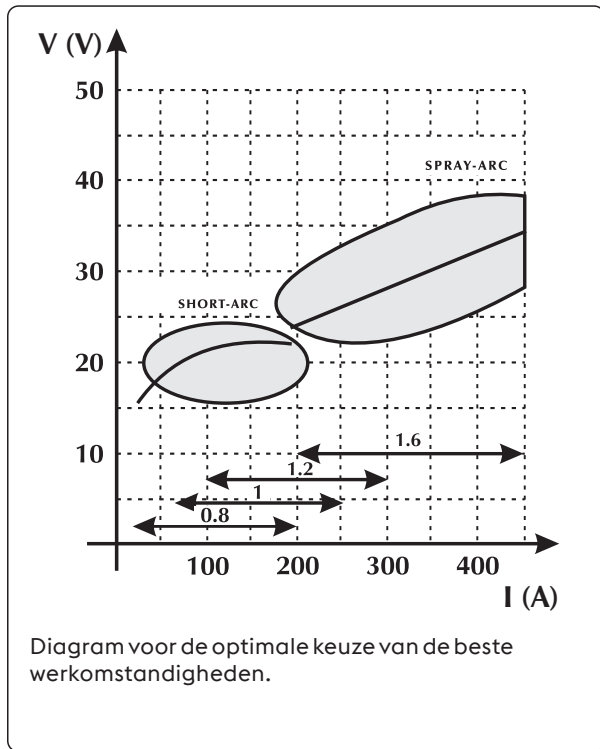

De zichtbaarheid van de boog vermindert de noodzaak voor de lasser om de regeltabellen streng in het oog te houden omdat hij het smeltbad direct kan controleren.

- De stroomspanning beïnvloedt direct het ontstaan van de druppel, maar de afmeting van de lasdruppel kan variëren al naar gelang het handmatig bewegen van de toorts om variabele afzettingen te krijgen met constante stroomspanning.
- De snelheid van de draadtoevoer is in verhouding met de lasstroom.

Na následujících dvou obrázcích jsou zobrazeny vztahy mezi jednotlivými parametry svařování.

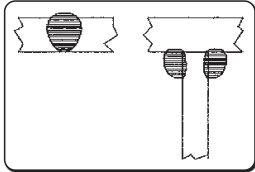
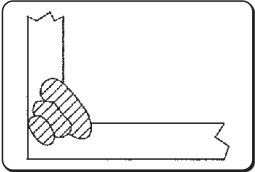
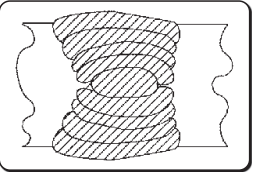

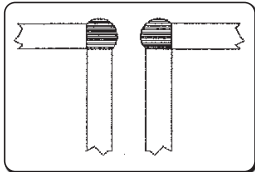
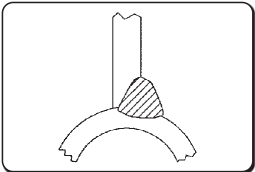
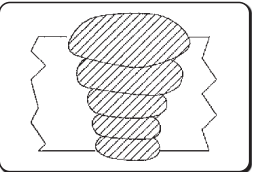
Keuze tabel voor de juiste parameters met betrekking tot de meesttypische toepassingen en de meest gebruikte draden

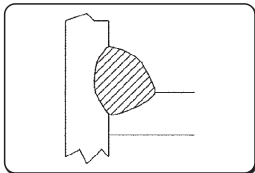
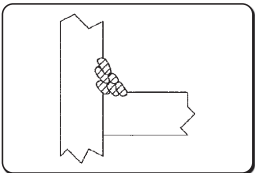
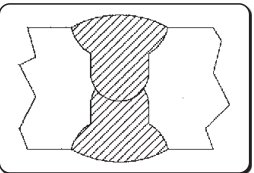
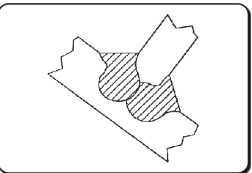
Boogspanning	Ø 0,8 mm	Ø 1,0-1,2 mm	Ø 1,6 mm	Ø 2,4 mm	
16V - 22V SHORT - ARC					
	60 - 160 A Geringe penetratie voor dunne werkstukken	100 - 175 A Goede controle van de penetratie en de smelting	120 - 180 A Goede smelting horizontaal en vertikaal	150 - 200 A Niet gebruikt	
	24V - 28V SEMI SHORT-ARC (Overgangszone)				
		150 - 250 A Automatisch Hoeklassen	200 - 300 A Automatisch lassen met hoge spanning	250 - 350 A Automatisch neer gaand lassen	300 - 400 A Niet gebruikt
30V - 45V SPRAY - ARC					
		150 - 250 A Geringe penetratie bij Afstelling op 200A	200 - 350 A Automatisch lassen met meervoudige doorgangen	300 - 500 A Goede penetratie bij neergaand Lassen	500 - 750 A Goede penetratie hoge afzetting op dikke werkstukken

Bruikbare gassoorten

Het MIG-MAG lassen wordt voornamelijk gekenmerkt door het type gas dat wordt gebruikt, edel gas voor het MIG lassen (Metaal Edel Gas), en actief voor het MAG lassen (Metaal Actief Gas).

- Kooldioxide (CO₂)

Het gebruik van CO₂ als beschermgas zorgt voor grote penetraties met hoge voortgangssnelheid en goede mechanische eigenschappen terwijl de kosten laag blijven. Anderzijds vormt het gebruik van dit gas aanzienlijke problemen ten aanzien van de uiteindelijke chemische samenstelling van de lasnaden omdat er gemakkelijk oxiderende elementen verloren gaan terwijl tegelijkertijd het smeltbad wordt verrijkt met koolstof. Het lassen met zuiver CO₂ geeft ook andere problemen zoals teveel spatten en de vorming van poreusheid.

- Argon

Dit gas wordt puur gebruikt bij het lassen van lichte legeringen terwijl bij het lassen van chroomnikkel roestvrij staal de voorkeur gegeven wordt aan het gebruik van argon met toevoeging van zuurstof en CO₂ in het percentage 2% omdat dit bijdraagt aan de stabiliteit van de boog en de vorming van druppels bevordert.

- Helium

Dit gas wordt gebruikt als alternatief voor argon en zorgt voor grotere penetratie (op dik materiaal) en grotere voortgangssnelheid.

- Argon-Helium mengsel

Zorgt voor een meer stabiele boog ten opzichte van zuiver helium en een grotere penetratie en hogere snelheid ten opzichte van argon.

- Argon-CO₂ en Argon-CO₂-Zuurstof mengsel

Deze mengsels worden gebruikt bij het lassen van ijzerhoudende materialen vooral bij Short-Arc omdat ze de warmte inbreng verbeteren. Ze kunnen ook worden gebruikt bij Spray-Arc.

Gewoonlijk bevat het mengsel een percentage CO₂ dat varieert van 8% tot 20% en O₂ van ongeveer 5%.

Raadpleeg het de handleiding van het systeem.

10. TECHNISCHE KENMERKEN

Elektrische kenmerken			U.M.
Netspanning U1 (50/60 Hz)	3x230 (±15%)	3x400 (±15%)	Vac
Zmax (@PCC)*	62	62	mΩ
Vertraagde lijnzekering	30	20	A
Can-bus aansluiting	DIGITAAL	DIGITAAL	
Maximaal opgenomen vermogen	13.3	13.0	kVA
Maximaal opgenomen vermogen	12.8	12.4	kW
Opgenomen vermogen in uitgeschakelde stand	71	71	W
Vermogen factor (PF)	0.96	0.95	
Rendement (μ)	85	85	%
Cos φ	0.99	0.99	
Maximaal opgenomen stroom I1max	32.9	18.8	A
Effectieve Stroom I1 eff	20.8	13.3	A
Instelbereik (MMA)	3-320	3-320	A
Nullastspanning Uo	75	75	Vdc

*Deze apparatuur voldoet aan de EN / IEC 61000-3-11 norm.

*Deze apparatuur voldoet aan de norm EN / IEC 61000-3-12 als de maximaal toelaatbare stroom impedantie met betrekking tot de interface op het elektrische netwerk (bij een normale aansluiting) kleiner is dan of gelijk is aan de vastgestelde "Zmax" waarde. Wanneer het wordt aangesloten op het normale netwerk met een laag voltage, is het de verantwoordelijkheid van de installateur of de gebruiker van de apparatuur zich ervan te vergewissen, zonodig door de netwerkbeheerder te raadplegen, dat de apparatuur mag worden aangesloten.

Gebruiksfactor	3x230V	3x400V	U.M.
Gebruiksfactor MMA (40°C)			
(X=35%)	320	-	A
(X=50%)	-	320	A
(X=60%)	270	300	A
(X=100%)	230	250	A
Gebruiksfactor MMA (25°C)			
(X=60%)	320	320	A
(X=100%)	270	270	A
Gebruiksfactor TIG (40°C)			
(X=45%)	320	-	A
(X=60%)	300	320	A
(X=100%)	250	270	A
Gebruiksfactor TIG (25°C)			
(X=70%)	320	320	A
(X=100%)	270	270	A
Gebruiksfactor MIG/MAG (40°C)			
(X=35%)	320	-	A
(X=50%)	-	320	A
(X=60%)	280	310	A
(X=100%)	230	250	A
Gebruiksfactor MIG/MAG (25°C)			
(X=60%)	320	-	A
(X=70%)	-	320	A
(X=100%)	270	270	A

Fysieke eigenschappen			U.M.
IP Beveiligingsgraad	IP23S		
Isolatieklasse	H		
Afmetingen (lxdxh)	620x240x460		mm
Gewicht	26.7		Kg
Constructienormen	EN IEC 60974-1/A1:2019 EN IEC 60974-3:2019 EN 60974-10/A1:2015		
Gedeelte elektriciteitskabel	4x4		mm ²
Lengte van de stroomtoevoerkabel	5		m

11. TECHNISCHE GEGEVENS

VOESTALPINE BÖHLER WELDING SELCO S.R.L. Via Palladio, 19 - ONARA (PADOVA) - ITALY					
URANOS NX 3200 PME		N°			
		X (40°C)	50% (35%)	60%	100%
		I ₂	320A (320A)	300A (270A)	250A (230A)
		U ₂	32.8V (32.8V)	32.0V (30.8V)	30.0V (29.2V)
		X (40°C)	(45%)	60%	100%
		I ₂	(320A)	320A (300A)	270A (250A)
		U ₂	(22.8V)	22.8V (22.0V)	20.8V (20.0V)
		X (40°C)	50% (35%)	60%	100%
		I ₂	320A (320A)	310A (280A)	250A (230A)
		U ₂	30.0V (30.0V)	29.5V (28.5V)	26.5V (25.5V)
U ₁ 400V(230V)		I _{1max} 18.8A(32.9A)		I _{1eff} 13.3A(20.8A)	
IP 23 S					

12. BETEKENIS GEGEVENSPLAATJE

1		2					
3			4				
5		6					
7	9	23					
		11					
8	10	12	15	16	17		
		13	15A	16A	17A		
		14	15B	16B	17B		
7	9	11					
		11					
8	10	12	15	16	17		
		13	15A	16A	17A		
		14	15B	16B	17B		
18		19		20		21	
22							

- 1 Fabrieksmerk
- 2 Naam en adres van de fabrikant
- 3 Model van de apparatuur
- 4 Serienummer
X**XX**XXXXXXXXXX Bouwjaar
- 5 Symbool van het type lasapparaat
- 6 Verwijzing naar de constructienormen
- 7 Symbool van het lasproces
- 8 Symbool voor lasapparaten die geschikt zijn om te werken in een omgeving met verhoogd risico op elektrische schokken
- 9 Symbool van de lasroom
- 10 Nominale nullastspanning
- 11 Bereik van de maximale en minimale nominale lasroom en de overeenkomstige traditionele lastspanning
- 12 Symbool van de intermitterende cyclus
- 13 Symbool van de nominale lasroom
- 14 Symbool van de nominale lastspanning
- 15 Waarden van de intermitterende cyclus
- 16 Waarden van de intermitterende cyclus
- 17 Waarden van de intermitterende cyclus
- 15A Waarden van de nominale lasroom
- 16A Waarden van de nominale lasroom
- 17A Waarden van de nominale lasroom
- 15B Waarden van de traditionele lastspanning
- 16B Waarden van de traditionele lastspanning
- 17B Waarden van de traditionele lastspanning
- 18 Symbool voor de voeding
- 19 Nominale voedingsspanning
- 20 Nominale maximale voedingsstroom
- 21 Effectieve maximale voedingsstroom
- 22 Beschermingsgraad
- 23 Nominale piekspanning

CE EU-Conformiteitsverklaring
 EAC EAC-Conformiteitsverklaring
 UKCA UKCA-Conformiteitsverklaring

EU-FÖRSÄKRAN OM ÖVERENSSTÄMMELSE

Byggaren

voestalpine Böhler Welding Selco S.r.l. - Via Palladio, 19 - 35019 Onara di Tombolo (PD) - ITALY
Tel. +39 049 9413/111 - Fax +39 049 9413/311 - www.voestalpine.com/welding

förklarar under ensam ansvar att följande produkt:

URANOS NX 3200 PME 55.03.066
55.03.070

överensstämmer med direktiven EU:

2014/35/EU LOW VOLTAGE DIRECTIVE
2014/30/EU EMC DIRECTIVE
2011/65/EU RoHS DIRECTIVE

och att följande harmoniserade standarder har tillämpats:

EN IEC 60974-1/A1:2019 WELDING POWER SOURCE
EN 60974-10/A1:2015 ELECTROMAGNETIC COMPATIBILITY REQUIREMENTS

Dokumentationen som intygar överensstämmelse med direktiven kommer att finnas tillgänglig för inspektioner hos ovannämnda tillverkare.

Ingrepp eller modifieringar utan tillstånd av Böhler Welding Selco S.r.l. medför att denna försäkran inte längre är giltig.

Onara di Tombolo, 15/10/2021

voestalpine Böhler Welding Selco s.r.l.

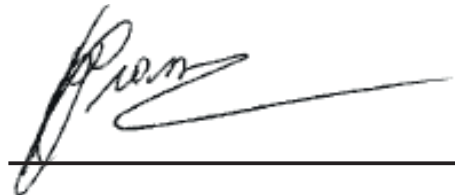

Lino Frasson

INNEHÅLLSFÖRTECKNING

1. VARNING	329
1.1 Driftsmiljö	329
1.2 Personligt skydd och skydd för tredje man.....	329
1.3 Skydd mot rök och gas	330
1.4 Skydd mot bränder/explosioner.....	330
1.5 Försiktighetsåtgärder vid användning av gasbehållare	331
1.6 Skydd mot elektriska urladdningar	331
1.7 Elektromagnetiska fält och störningar	331
1.8 IP-skyddsgrad	332
1.9 Jäätmekåitlus	332
2. INSTALLATION	332
2.1 Lyftning, transport och lossning	332
2.2 Aggregatets placering.....	333
2.3 Inkoppling.....	333
2.4 Igångsättning	333
3. BESKRIVNING AV AGGREGATET	335
3.1 Bakre kontrollpanel.....	335
3.2 Kopplingstavla	336
3.3 Främre kontrollpanel	336
3.4 Främre kontrollpanel	336
4. ANVÄNDNING AV UTRUSTNINGEN	337
4.1 Igångsättningskärm	337
4.2 Testskärm	337
4.3 Huvudskärmen	338
4.4 Huvudskärmbild för MMA-process	338
5. SETUP	345
5.1 Set-up och ställa in parametrar	345
5.2 Särskilda procedurer för användning av parametrar	354
6. UNDERHÅLL	359
6.1 Periodiska kontroller av generatorm.....	359
6.2 Odpowiedzialność	359
7. LARMKODER	359
8. FELSÖKNING OCH TIPS	361
9. TEORETISKA PRINCIPER FÖR SVETSNING	365
9.1 Svetsning med belagd elektrod (MMA)	365
9.2 TIG-Svetsning (kontinuerlig båge).....	365
9.3 Svetsning med kontinuerlig tråd (MIG/MAG)	367
10. TEKNISKA DATA	370
11. MÄRKPLÅT	372
12. MÄRKPLÅTENS INNEBÖRD	372
13. KOPPLINGSSHEMA	557
14. KONTAKTDON	559
15. RESERVDELSLISTA	560

SYMBOLER



Överhängande fara som orsakar allvarlig skada och riskbeteende som kan orsaka allvarlig skada.



Beteende som kan orsaka lättare personskador eller saksador.



Tekniska anmärkningar som underlättar arbetet.

1. VARNING



Läs den här instruktionsboken ordentligt och se till att du har förstått anvisningarna innan du börjar arbeta med maskinen.

Modifiera inte maskinen och utför inget underhåll som inte anges här. Tillverkaren påtar sig inget ansvar för person- eller sakskador som uppkommer till följd av att denna instruktionsbok inte har lästs uppmärksam eller att instruktionerna i den inte har följts.

Navodila za uporabo vedno hranite na kraju, kjer uporabljate opremo. Poleg navodil za uporabo upoštevajte splošna pravila in lokalne predpise na področju preprečevanja nesreč in varovanja okolja.



Vse osebe, ki so odgovorne za zagon, uporabo, vzdrževanje in popraviljanje opreme, morajo:

- imeti ustrezno kvalifikacijo
- imeti potrebno znanje na področju varjenja
- v celoti prebrati ta navodila za uporabo in jih dosledno upoštevati

Rådfråga fackman om du är tveksam till hur aggregatet ska användas eller om du får problem.

1.1 Driftsmiljö



Aggregaten får endast användas för de ändamål som de har konstruerats för, på de sätt och de områden som anges på märkplåten och/eller i denna instruktionsbok, i enlighet med nationella och internationella säkerhetsnormer. Användning som avviker från vad tillverkaren uttryckligen har föreskrivit ska betraktas som helt olämplig och farlig. Tillverkaren påtar sig inget ansvar i sådana fall.



Denna apparat får endast användas för professionellt bruk i industrimiljö. Tillverkaren påtar sig inget ansvar för skador som orsakas av att aggregatet används i hemmiljö.



Aggregatet ska användas i omgivningar med temperatur på mellan -10 °C och +40 °C (mellan +14 °F och +104 °F).

Aggregatet ska transporteras och förvaras i omgivningar med temperatur på mellan -25 °C och +55 °C (mellan -13 °F och +131 °F).

Miljön ska vara fri från damm, syror, gaser och andra frätande ämnen.

Den relativa luftfuktigheten ska vara högst 50 % vid 40 °C (104 °F).

Den relativa luftfuktigheten ska vara högst 90 % vid 20 °C (68 °F).

Aggregatet får användas på en höjd av högst 2000 m över havet (6500 fot).



Använd inte maskinen till att avfrosta rör.

Använd inte aggregatet för att ladda batterier och/eller ackumulatorer.

Använd inte aggregatet för att starta motorer.

1.2 Personligt skydd och skydd för tredje man



Svetsning ger upphov till skadlig strålning, buller, värme- och gasutveckling. Sätt upp en brandhärdig skiljevägg för att skydda svets från strålar, gnistor och het slagg. Varna eventuella utomstående för att de inte ska stirra på svetstället och uppmana dem att skydda sig emot strålning och het metall.



Använd skyddskläder samt svetshjälm för att skydda huden mot strålning. Använd arbetskläder som täcker hela kroppen och är:

- hela och i gott skick
- brandhärdiga
- isolerande och torra
- åtsittande och utan slag



Använd alltid skor som uppfyller kraven i regler och bestämmelser och är motståndskraftiga och vattenisolerande.

Använd alltid handskar som uppfyller kraven i regler och bestämmelser och som ger elektrisk och termisk isolering.



Använd masker med sidoskydd för ansiktet och lämpligt skyddsfilter (minst NR10) för ögonen.



Använd alltid skyddsglasögon med sidoskydd, särskilt vid manuell eller mekanisk slaggborttagning.



Använd inte kontaktlinser!



Använd hörselskydd om svetsningen ger upphov till skadligt buller. Avgränsa arbetsområdet om bullernivån överskrider lagens gränser och tillse att de personer som kommer in i området har hörselskydd.



Håll alltid sidopanelerna stängda under svetsningen. Aggregatet får inte modifieras på något sätt.



Håll alltid sidopanelerna stängda under svetsningen. Undvik kontakt mellan händer, hår, plagg, redskap och dylikt och rörliga delar som: fläktar, drev, valsar och axlar, trådrollar. Arbeta inte på dreven när trådmatningsenheten är i drift. Aggregatet får inte modifieras på något sätt. Det är oerhört farligt att koppla bort skyddena på trådmatningsenheterna. Tillverkaren påtar sig inget ansvar för person- eller saksador om detta görs.



Håll huvudet på avstånd från MIG-/MAG-brännaren när du sätter i och matar fram tråden. Den tråd som matas ut kan orsaka allvarliga skador på händer, ansikte och ögon.



Undvik att röra arbetsstycken som just har svetsats, eftersom den höga värmen kan medföra allvarliga brännskador. Vidtag alla ovan beskrivna försiktighetsåtgärder också vid bearbetning efter svetsningen, eftersom slag kan lossna från arbetsstycken som håller på att svalna.



Kontrollera att brännaren har svalnat innan du utför arbeten eller underhåll på den.



Kontrollera att kylvattenheten är avstängd innan du kopplar loss matarslangen och returslangen för kylvätskan. Den heta vätskan kan ge allvarliga brännskador.



Ha första hjälpen-utrustning tillgänglig. Banalisera inte brännskador eller sår.



Säkra det område du ansvarar för innan du lämnar arbetsplatsen, för att motverka risken för person- och saksador.

1.3 Skydd mot rök och gas



Rök, gas och damm som uppstår under svetsningen kan vara skadligt för hälsan.

Rök som uppstår under svetsningen kan under vissa omständigheter leda till cancer eller skador på gravida kvinnors foster.

- Håll huvudet på avstånd från svetsgaserna och svetsröken.
- Tillse att arbetsområdet har en tillräckligt god naturlig eller forcerad ventilation.
- Använd ansiktsmask med andningsapparat om ventilationen är otillräcklig.
- Vid svetsning i trånga utrymmen rekommenderar vi att operatören övervakas av en kollega som befinner sig utanför utrymmet i fråga.
- Använd inte syre för ventilationen.
- Kontrollera med jämna mellanrum att insugningen är effektiv genom att jämföra utsläppen av skadliga gaser med de värden som säkerhetsbestämmelserna tillåter.
- Hur mycket rök som produceras och hur farlig denna är beror på det använda grundmaterialet, svetsmaterialet och eventuella ämnen som används för att rengöra eller avfetta de arbetsstycken som ska svetsas. Följ tillverkarens anvisningar och tekniska instruktioner noggrant.
- Svetsa inte i närheten av platser där avfettning eller lackering pågår.
- Placera gasbehållarna i öppna utrymmen eller i utrymmen med god luftcirkulation.

1.4 Skydd mot bränder/explosioner



Svetsningen kan ge upphov till bränder och/eller explosioner.

- Avlägsna eldfarligt och brännbart material och föremål från arbetsområdet och dess omgivningar.
- Inget brännbart material får finnas inom 11 meter (35 fot) från svetsstället om det inte skyddas ordentligt.
- Gnistor och glödande partiklar kan lätt komma ut i omgivningen också genom små öppningar. Var mycket noggrann med att sätta föremål och personer i säkerhet.
- Svetsa inte på eller i närheten av tryckutsatta behållare.
- Svetsa inte i stängda behållare eller rör. Var mycket försiktig vid svetsning av behållare eller tuber, även om dessa har öppnats, tömts och rengjorts noggrant. Rester av gas, bränsle, olja eller liknande kan medföra explosioner.
- Svetsa inte i atmosfär som innehåller damm, gas eller explosiva ångor.
- Kontrollera att den spänningsförande kretsen inte av misstag kan komma i kontakt med delar som är anslutna till jordkretsen när svetsningen är avslutad.
- Anordna med brandsläckningsutrustning eller ett brandskyddssystem i närheten av arbetsområdet.

1.5 Försiktighetsåtgärder vid användning av gasbehållare



Behållare med skyddsgas innehåller gas under tryck och kan explodera om inte minimivillkoren för transport, förvaring och användning är uppfyllda.

- Behållarna ska fästas i vertikalt läge i väggar eller annat på lämpligt sätt för att undvika fall och mekaniska sammanstötningar.
- Skruva på skyddshatten på ventilen under transport, idrifttagning och efter avslutad svetsning.
- Undvik att utsätta behållarna för direkt solljus och stora temperaturvariationer. Utsätt inte behållarna för mycket låga eller höga temperaturer.
- Undvik att behållarna kommer i kontakt med öppna lågor, elektriska bågar, brännare eller elektrodhållare och gnistor från svetsningen.
- Håll behållarna på avstånd från svetskretsarna och strömkretsar i allmänhet.
- Håll huvudet på avstånd från gasutloppet när du öppnar ventilen på behållaren.
- Stäng alltid ventilen på behållaren efter avslutad svetsning.
- Svetsa aldrig på tryckutsatta gasbehållare.
- Anslut aldrig en tryckluftsbehållare direkt till maskinens tryckregulator! Trycket kan överstiga tryckregulatorns kapacitet och få denna att explodera!

1.6 Skydd mot elektriska urladdningar



Elektriska urladdningar kan vara livsfarliga.

- Undvik att vidröra delar som normalt är spänningsförande inuti eller utanför svetsstatet när det är strömförsörjt (brännare, gripklor, jordledare, elektroder, trådar, valsar och rullar är elektriskt anslutna till svetskretsen).
- Se till att aggregatet och operatören isoleras elektriskt genom att använda torra plan och underreden som är tillfredsställande isolerade från nollpotentialen och jordpotentialen.
- Se till att aggregatet ansluts korrekt till en stickpropp och ett jordat elnät.
- Vidrör inte två brännare eller två elektrodhållare samtidigt.
- Avbryt omedelbart svetsningen om du får en elektrisk stöt.

1.7 Elektromagnetiska fält och störningar



När strömmen passerar genom ledningarna i och utanför aggregatet skapas ett elektromagnetiskt fält i svetskablarnas och aggregatets omedelbara närhet.

- Elektromagnetiska fält kan ha (hittills okända) hälsoeffekter för den som exponeras långvarigt för dem.
- Elektromagnetiska fält kan interferera med annan utrustning som pacemakar och hörapparater.



Bärare av livsuppehållande elektronisk apparatur (pacemaker) måste konsultera läkare innan de närmar sig platser där bågsvetsning.

1.7.1 EMC-klassificeras i enlighet med: EN 60974-10/A1:2015.

Klass B

Utrustning i klass B följer kraven på elektromagnetisk kompatibilitet för industri- och boendemiljöer, inklusive för bostadsområden där el levereras via det allmänna lågspänningsnätet.

Klass A

Utrustning i klass A är inte avsedd för bruk i bostadsområden där elen levereras via det allmänna lågspänningsnätet. Det kan vara svårt att garantera elektromagnetisk kompatibilitet för utrustning i klass A på sådana platser, på grund av såväl ledningsbundna som strålade störningar.

För mer information, se kapitlet: MÄRKPLÅT eller TEKNISKA DATA.

1.7.2 Installation, drift och omgivningsbedömning

Denna apparat är konstruerad i överensstämmelse med anvisningarna i den harmoniserade standarden EN 60974-10/A1:2015 och tillhör Klass A. Denna apparat får endast användas för professionellt bruk i industrimiljö. Tillverkaren påtar sig inget ansvar för skador som orsakas av att aggregatet används i hemmiljö.



Användaren ska vara expert på området och är som sådan ansvarig för att apparaten installeras och används enligt tillverkarens anvisningar. Vid eventuella elektromagnetiska störningar ska användaren lösa problemet med hjälp av tillverkarens tekniska service.



De elektromagnetiska störningarna måste alltid minskas så mycket att de inte medför besvär.



Innan apparaten installeras ska användaren bedöma vilka eventuella elektromagnetiska problem som kan uppstå i det omgivande området och särskilt hälsotillståndet hos personalen i området, till exempel de som använder pacemakar eller hörapparater.

SV

1.7.3 Krav på nätanslutningen

På grund av att primärströmmen dras från nätanslutningen kan högeffektutrustning påverka ledningsnätets ström kvalitet. Av den anledningen kan det förekomma anslutningsbegränsningar eller krav på en maximal impedans som tillåts i elnätet (Z_{max}) eller en minsta tillförselskapacitet (S_{sc}) som krävs vid gränssnittet mot det allmänna ledningsnätet (leveranspunkten) för viss utrustning (se tekniska data). Om så är fallet är det den som installerar eller använder utrustningen som ansvarar för att kontrollera att utrustningen får anslutas (genom att rådfråga elnätsleverantören vid behov). Vid störningar kan man behöva vidta ytterligare försiktighetsåtgärder, såsom filtrering av nätströmmen.

Man bör också överväga möjligheten att skärma strömförsörjningskabeln.

För mer information, se kapitlet: TEKNISKA DATA.

1.7.4 Försiktighetsåtgärder avseende kablar

Följ nedanstående anvisningar för att minimera effekterna av de elektromagnetiska fälten:

- Rulla ihop jordledaren och elkabeln och fäst dem när så är möjligt.
- Undvik att rulla ihop kablarna i närheten av kroppen.
- Undvik att vistas mellan jordledaren och elkabeln (hålla båda på samma sida).
- Ledningarna ska hållas så korta som möjligt och ska placeras nära varandra och löpa på eller i närheten av golvnivån.
- Placera aggregatet på avstånd från svetszonen.
- Placera kablarna på avstånd från eventuella andra kablar.

1.7.5 Ekvipotentialförbindning

Man bör överväga att jorda alla metalldelar i svetsanläggningen och i dess närhet. Följ nationella bestämmelser om ekvipotentialförbindning.

1.7.6 Jordning av arbetsstycket

Om arbetsstycket av elsäkerhetsskäl eller beroende på dess storlek eller placering inte är jordat kan en jordledning mellan arbetsstycket och jorden minska emissionerna. Man måste se till att jordningen av arbetsstycket inte ökar risken att användarna skadas eller skadar andra elektriska apparater. Följ nationella bestämmelser om jordning.

1.7.7 Skärmning

Selektiv skärmning av andra kablar och apparater i omgivningarna kan minska störningsproblemen.

För speciella applikationer kan man överväga att skärma hela svetsanläggningen.

1.8 IP-skyddsgrad



IP23S

- Höljjet förhindrar att man kommer åt farliga delar med fingrarna och skyddar mot fasta främmande föremål med en diameter på 12,5 mm eller mer.
- Höljjet skyddar mot regn i 60° vinkel mot vertikalled.
- Höljjet är skyddat mot skador till följd av inträngande vatten när utrustningens rörliga delar inte är i rörelse.

1.9 Jåtmekåitlus



Bortskaffa inte elutrustningen tillsammans med vanligt avfall!

I enlighet med direktiv 2012/19/EU om avfall som utgörs av eller innehåller elektrisk och elektronisk utrustning och bestämmelserna om dess införlivande med nationell lagstiftning ska uttjänad elutrustning samlas in separat och lämnas till en insamlings- och återvinningscentral. Utrustningens ägare ska vända sig till kommunen för att identifiera de auktoriserade insamlingscentralerna. Tillämpningen av EU-direktivet kommer att bidra till att förbättra miljön och människors hälsa.

2. INSTALLATION



Endast personal med specialkunskaper och tillstånd från tillverkaren får installera kylväxelnheten.



Se till att generatorn är ansluten till elnätet innan installationen görs.



Det är förbjudet att serie- eller parallellkoppla generatorerna.

2.1 Lyftning, transport och lossning

- Aggregatet har ett handtag så att du kan bära det.
- Aggregatet har inga särskilda lyftanordningar.
- Lyft det med gaffeltruck och var ytterst försiktig under förflyttningen så att inte generatorn faller.



Underskatta inte aggregatets vikt, se tekniska data.
Förflytta eller stoppa inte lasten ovanför människor eller föremål.
Låt inte aggregatet eller en enskild enhet falla eller ställas ned med en kraftig stöt.

2.2 Aggregatets placering



Tillämpa följande kriterier:

- Kommandon och kopplingar ska vara lättillgängliga.
- Placera inte utrustningen i trånga utrymmen.
- Placera inte aggregatet på ett plan som lutar mer än 10° i relation till horisontalplanet.
- Placera aggregatet på torr, ren plats med god ventilation.
- Skydda aggregatet mot regn och direkt solljus.

2.3 Inkoppling



Generatoren har en elsladd för anslutning till elnätet.
Strömförsörjningen till aggregatet kan vara:

- trefas 400 V
- trefas 230 V

Aggregatets funktion garanteras för spänningar som avviker upp till $\pm 15\%$ från det nominella värdet (exempel: om V_{nom} är 400 V ligger driftspänningen mellan 320 V och 440 V).



För att undvika personskador eller skador på aggregatet måste man kontrollera den valda nätspänningen och säkringarna INNAN maskinen ansluts till elnätet. Se dessutom till att kabeln ansluts till ett jordat uttag.



Aggregatet kan få sin strömtillförsel via en elgenerator på villkor att denna ger en stabil matningsström på $\pm 15\%$ av den nominella spänning som tillverkaren uppger under alla tänkbara driftförutsättningar och vid svetsgeneratorns maximala effekt. Som regel rekommenderas generatorer med 2 gånger så hög effekt som svetsgeneratorn vid enfasmatning och 1,5 gånger vid trefasmatning. Vi rekommenderar elektroniskt styrda elgeneratorer.



Aggregatet måste vara korrekt jordat för att skydda användarna. Strömförsörjningskabeln innehåller en gul/grön jordledning som ska anslutas till en jordad stickpropp. Denna gul-gröna ledning får ALDRIG användas tillsammans med en annan ledning för att leda ström. Kontrollera att elsystemet är jordat och att eluttaget är i gott skick. Montera endast godkända kontakter som uppfyller säkerhetsbestämmelserna.



Elsystemet ska utformas av teknisk personal som besitter särskilda yrkeskunskaper och arbetar i enlighet med lagstiftningen i det land där installationen görs.

2.4 Igångsättning

2.4.1 Anslutning för MMA-svetsning



En inkoppling som den i figuren resulterar i svetsning med omvänd polaritet.
Kasta om kopplingarna för svetsning med normal polaritet.

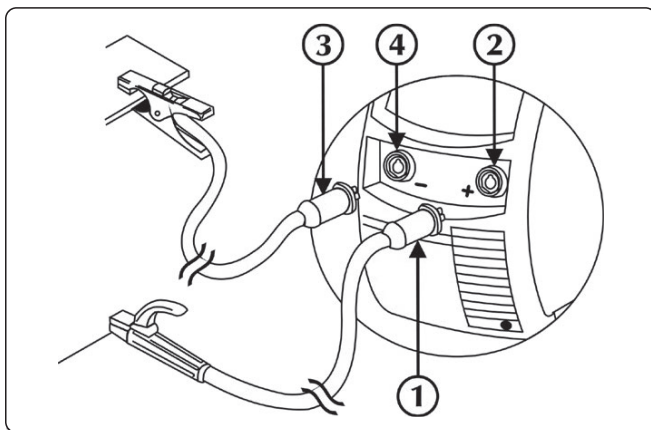

- ① Jordklämkontakt
- ② Negativt uttag (-)
- ③ Elektrodhållarens klämkontakt
- ④ Positivt uttag (+)

- ▶ Anslut jordklämman till kraftaggregatets negativa uttag (-). Sätt i stickproppen och vrid medsols så att den fästs ordentligt.
- ▶ Anslut elektrodhållaren till kraftaggregatets positiva uttag (+). Sätt i stickproppen och vrid medsols så att den fästs ordentligt.

2.4.2 Anslutning för TIG-svetsning

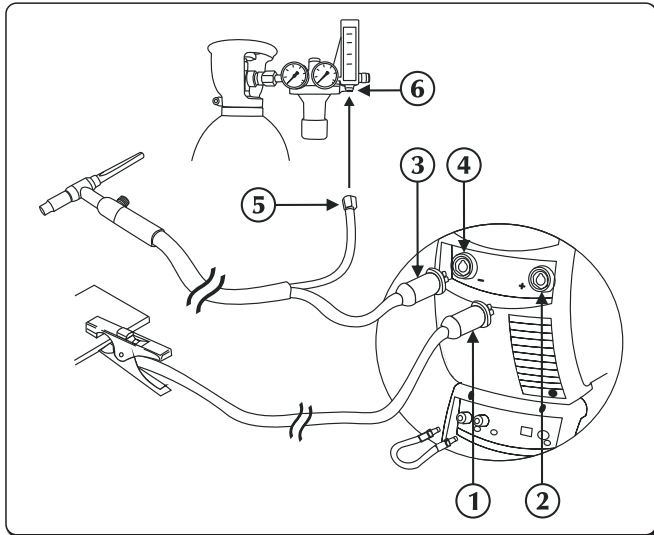

- ① Jordklämkontakt
- ② Positivt uttag (+)
- ③ TIG-fackelfäste
- ④ Brännaruttag
- ⑤ Anslutning för gasrör
- ⑥ Tryckreduceringen

- ▶ Anslut jordklämman till kraftaggregatets positiva uttag (+). Sätt i stickproppen och vrid medsols så att den fästs ordentligt.
- ▶ Anslut TIG-brännarens koppling till kraftaggregatets brännaruttag. Sätt i stickproppen och vrid medsols så att den fästs ordentligt.



Skyddsgasflödet ställs in med en kran som i regel sitter på brännaren.

- ▶ Anslut brännarens gasrör till gasdistributionsnätet.
- ▶ Anslut returslangen för kylvätska från brännaren (röd) till kopplingen (röd - symbol).
- ▶ Anslut matarslangen för kylvätska till brännaren (blå) till kopplingen (blå - symbol).

2.4.3 Anslutning för MIG-/MAG-svetsning

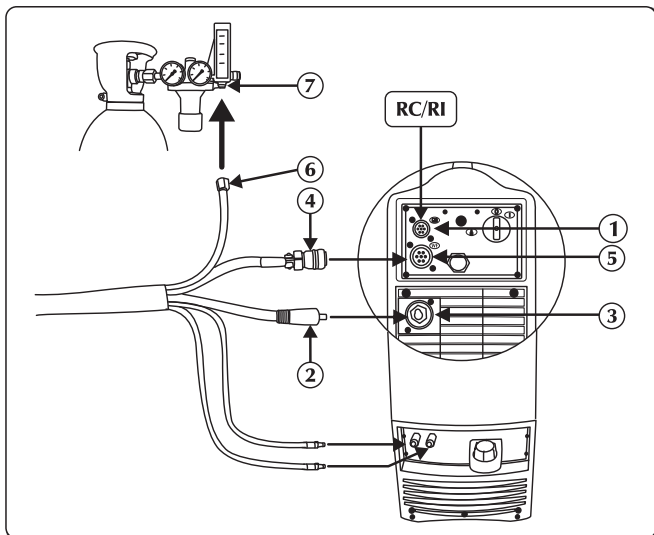

- ① Uttag för signalkabel (CAN-buss)
- ② Elkabel
- ③ Positivt uttag (+)
- ④ Signalkabel
- ⑤ Ingång för signalkabel (CAN-BUS) (ledningsknippe)
- ⑥ Gasrör
- ⑦ Koppling för gastillförsel

- ▶ Anslut elkabeln i ledningsknippet till uttaget. Sätt i stickproppen och vrid medsols så att den fästs ordentligt.
- ▶ Anslut signalkabeln i ledningsknippet till kontaktdonet. För in kontakten och vrid överfallsmuttern medurs för att låsa kontaktdelarna till varandra.
- ▶ Anslut gasslangen i ledningsknippet till gasbehållarens tryckregulator eller till gasuttaget. Ställ in gasflödet på mellan 10 och 30 l/min.
- ▶ Anslut matarslangen för kylvätska i ledningsknippet (blå) till kopplingen (blå - symbol).
- ▶ Anslut returslangen för kylvätska i ledningsknippet (röd) till kopplingen (röd - symbol).

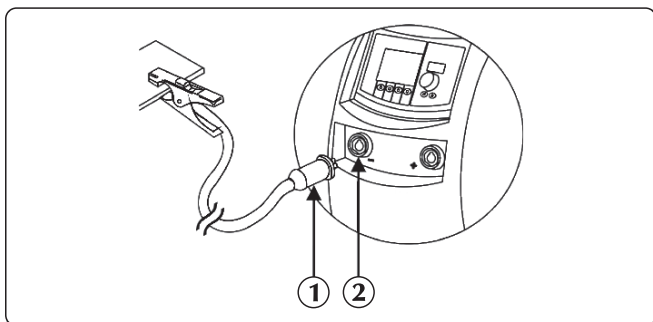

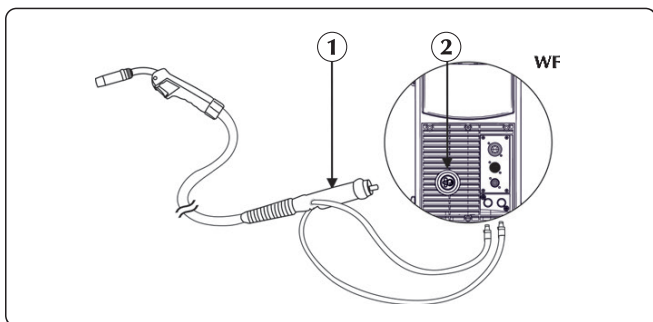

- ① Jordklämkontakt
- ② Negativt uttag (-)

► Anslut jordklämman till kraftaggregatets negativa uttag (-). Sätt i stickproppen och vrid medsols så att den fästs ordentligt.



- ① Brännaruttag
- ② Kontaktdon

- Anslut matarslangen för kylvätska till brännaren (blå) till kopplingen (blå - symbol ).
- Anslut returslangen för kylvätska från brännaren (röd) till kopplingen (röd - symbol ).
- Anslut MIG/MAG-brännaren till uttaget och var noga med att skruva åt låsringen helt.

3. BESKRIVNING AV AGGREGATET

3.1 Bakre kontrollpanel

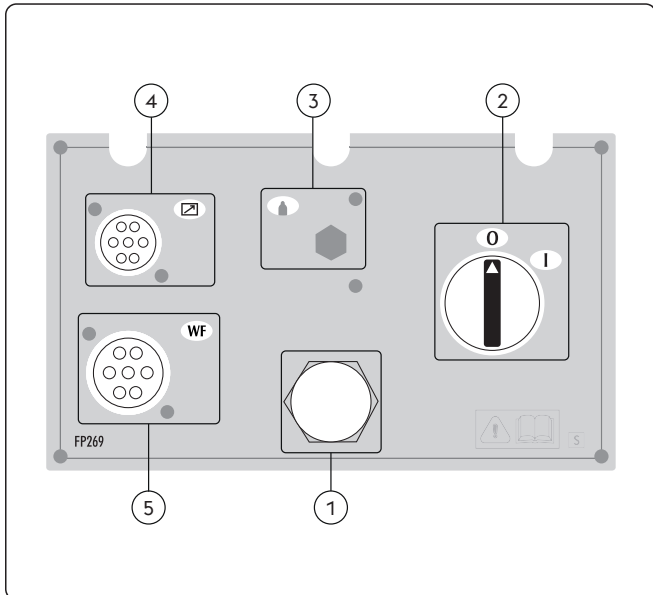

- ① Strömförsörjningskabel
För att strömförsörja anläggningen via elnätet.
- ② Huvudströmbrytare
För påsättning och avstängning av svetsaggregatet.
Har två lägen: "O" avstängd och "I" påslagen.
- ③ Inte använd
- ④ Uttag för signalkabel CAN-buss (RC, RI...)
- ⑤ Ingång för signalkabel (CAN-BUS)
(ledningsknippe)

3.2 Kopplingstavla

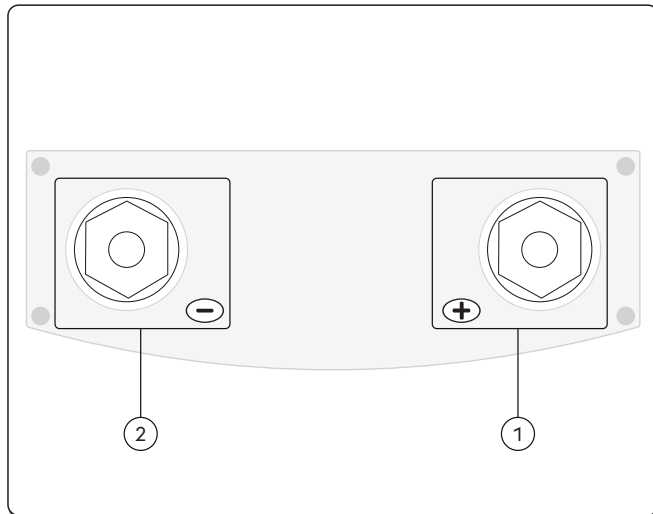

- ① **Positivt uttag (+)**
 Process MMA: Anslutning elektrobrännare
 Process TIG: Anslutning jordkabel
- ② **Negativt uttag (-)**
 Process MMA: Anslutning jordkabel
 Process TIG: Anslutning brännare
 MIG/MAG-process: Anslutning jordkabel

3.3 Främre kontrollpanel

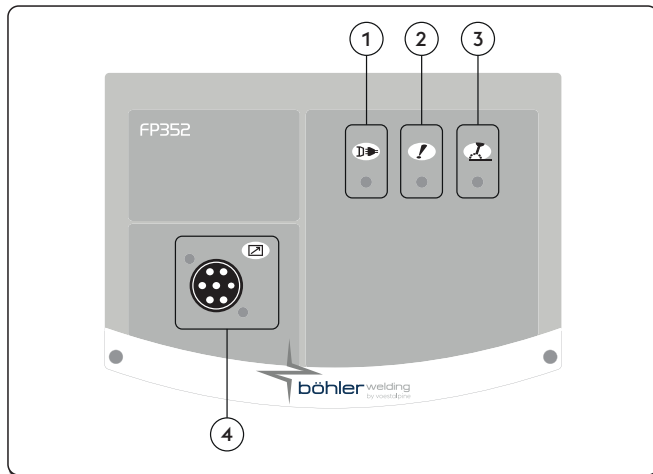





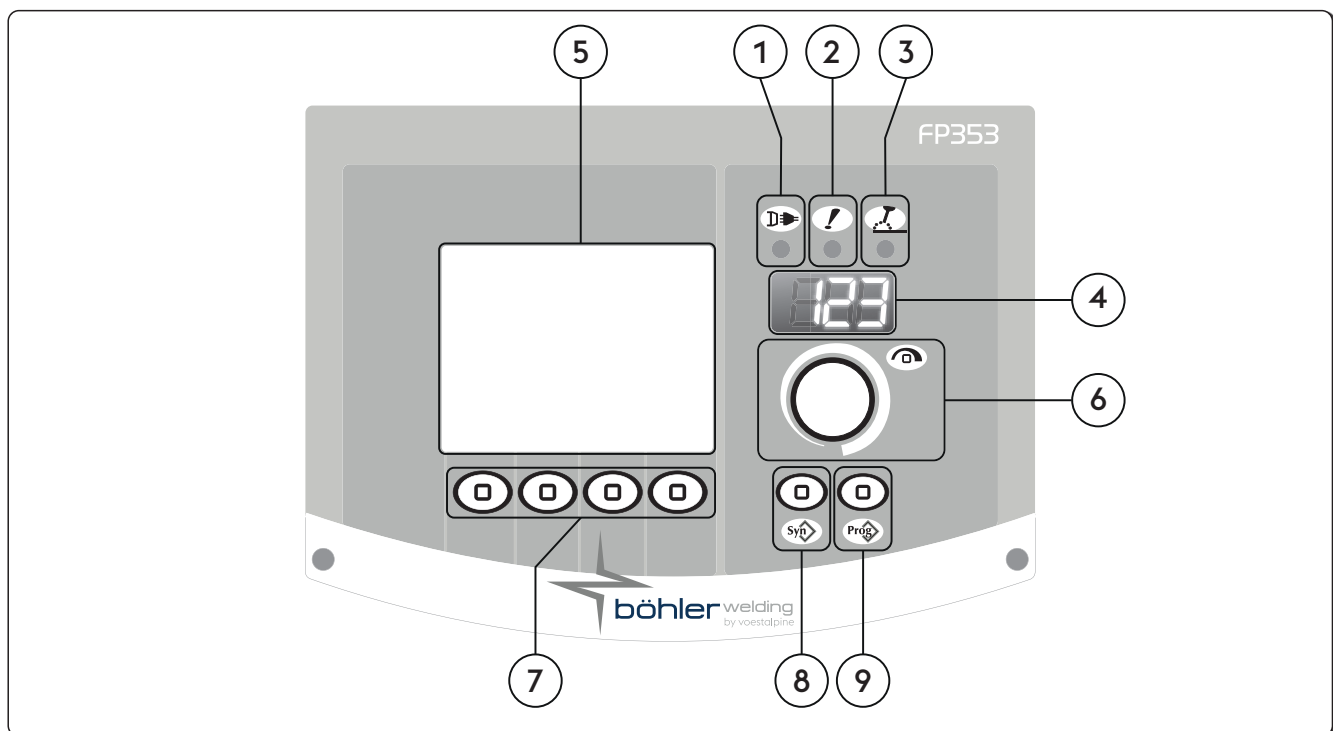



- ① **Ström-LED**
 Visar att utrustningen är ansluten till elnätet och påslagen.
- ② **Allmänt larm-LED**
 Visar när skyddsutrustning som temperaturkyddet aktiveras.
- ③ **Aktiv effekt-LED**
 Visar att det finns ström i utrustningens utgångar.
- ④ **Uttag för signalkabel CAN-buss (RC, RI...)**

3.4 Främre kontrollpanel



SV

- 1  **Ström-LED**
Visar att utrustningen är ansluten till elnätet och påslagen.
- 2  **Allmänt larm-LED**
Visar när skyddsutrustning som temperaturkyddet aktiveras.
- 3  **Aktiv effekt-LED**
Visar att det finns ström i utrustningens utgångar.
- 4  **Display med 7 segment**
Här visas de allmänna svetsparametrarna under start, inställningar, ström- och spänningsvärden vid svetsning samt larmkoder.
- 5  **LCD-display**
Här visas de allmänna svetsparametrarna under start, inställningar, ström- och spänningsvärden vid svetsning samt larmkoder.
Alla aktiviteter kan visas utan fördröjning.
- 6  **Huvudjusteringshandtag**
Gör det möjligt att konfigurera, välja och ställa in svetsparametrar.
- 7  **Funktionsknappar**
Medger val av olika systemfunktioner:
 - Svetsprocess
 - Svetsmetoder
 - Strömpulsning
 - Grafiskt gränssnitt
- 8  **Knapp för program**
Medger val av förinställt svetsprogram genom att välja några enkla inställningar:
 - Typ av tråd
 - Typ av gas
 - Wtråddiameter
- 9  **Knapp för jobb**
Medger lagring och hantering av 240 svetsprogram som kan anpassas till den enskilda användaren.

4. ANVÄNDNING AV UTRUSTNINGEN

SV

4.1 Igångsättnings-skärmen

När generatoren startas genomför den ett antal kontroller för att garantera att systemet fungerar korrekt, inklusive alla anslutna enheter. I samma skede genomförs också gastestet för att kontrollera att systemet för gastillförsel fungerar korrekt.

4.2 Testskärm

När sidopanelen (spolutrymmet) är öppet spärras svetsfunktionerna.
Testskärmen visas på LCD-displayen.

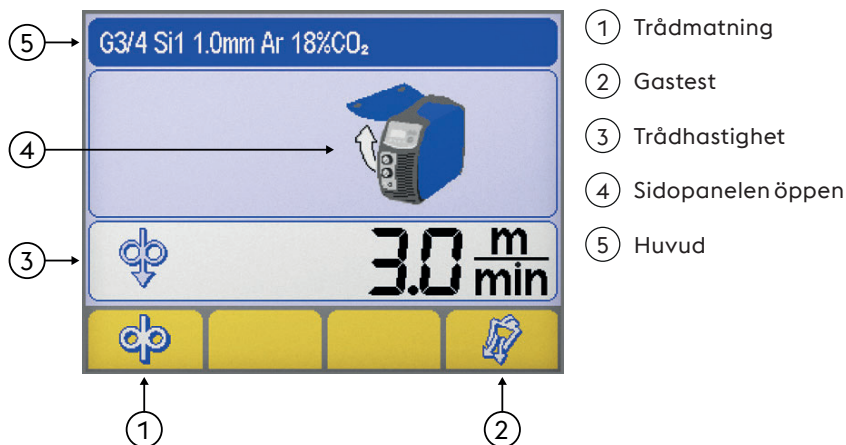



Trådmatning

Gör det möjligt att mata tråden manuellt utan gasflöde och utan ström till tråden.
Gör att man kan föra in tråden i brännarhöljet under svetsningens förberedelsefaser.



Gastest

Gör att man kan avlägsna föroreningar från gaskretsen och ställa in preliminärtryck och justera tryckluftens tryck utan att slå på strömmen.



Trårdhastighet

Medger inställning av trådmatningshastigheten (under lastningssteget).

Minimum	Maximum	Standard
0.5 m/min	22.0 m/min	3.0 m/min



Sidopanelen öppen



Huvud

Visar vissa viktiga uppgifter i relation till den valda processen.

4.3 Huvudskärmen

Används för att styra systemet och svetsprocessen. De viktigaste inställningarna visas.

4.4 Huvudskärmbild för MMA-process

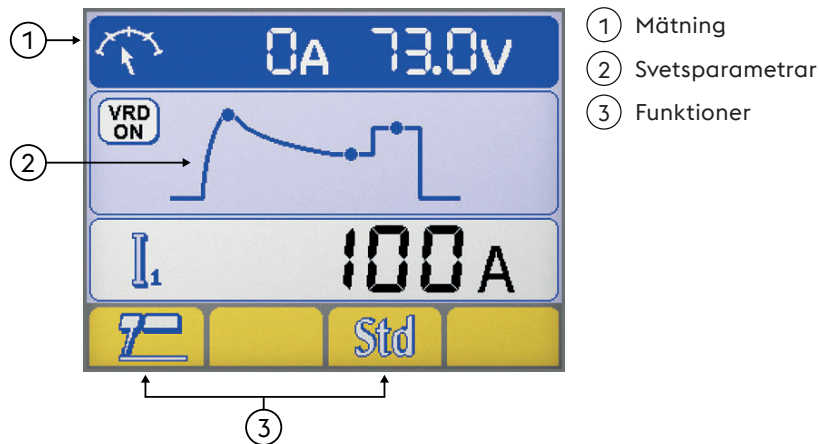

SV

Mätning

Under svetsningen visas de verkliga ström- och spänningsvärdena på LCD-displayen.

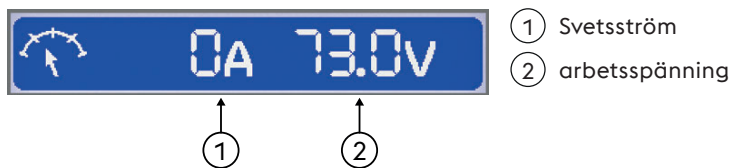

Svetsparametrar

► Välj önskad parameter genom att trycka på kodningsvredet.

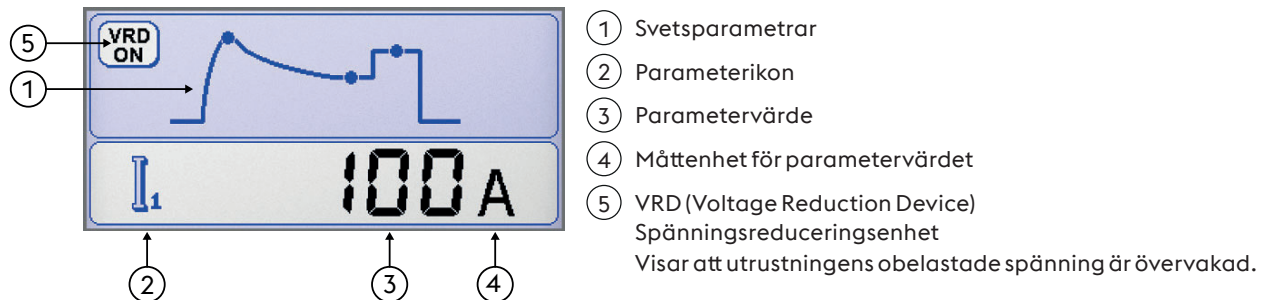

Funktioner

Medger inställning av de viktigaste processfunktionerna och svetsmetoderna.



Svetsprocess

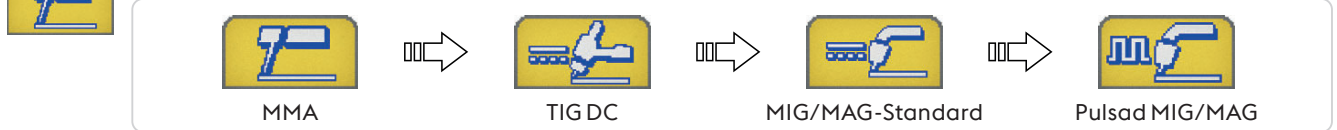

Synergisk MMA-svetsning

För inställning av den bästa bågodynamiken beroende på den typ av elektrod som används.

Genom att välja rätt bågodynamik kan strömkällan utnyttjas maximalt och bästa möjliga svetsegenskaper uppnås.



Perfekt svetsbarhet hos elektroden kan inte garanteras.

Svetsbarheten beror på tillsatsmaterialalets kvalitet och skick, drifts- och svetsförhållandena, antalet möjliga användningsområden m.m.

4.5 Huvudskärmbild för TIG-process

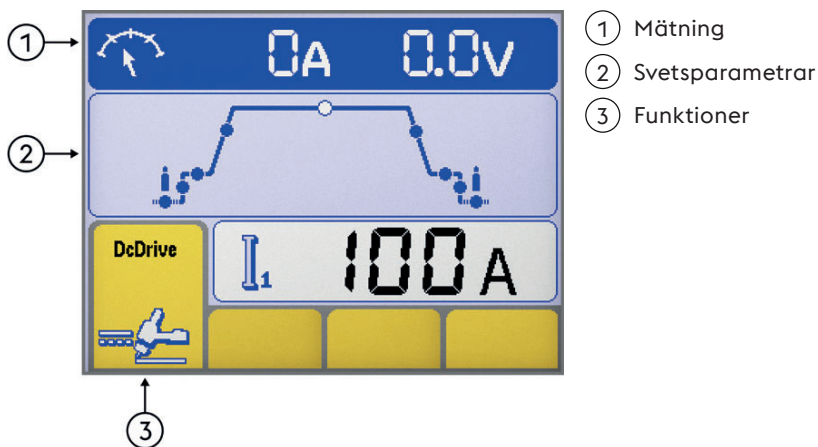

Mätning

Under svetsningen visas de verkliga ström- och spänningsvärdena på LCD-displayen.

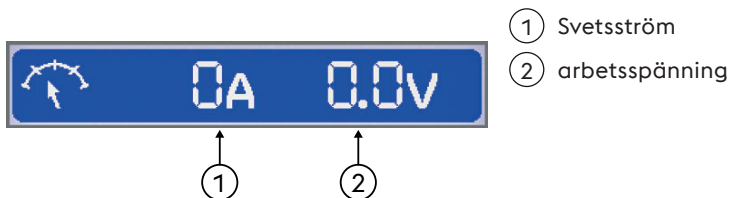

Svetsparametrar

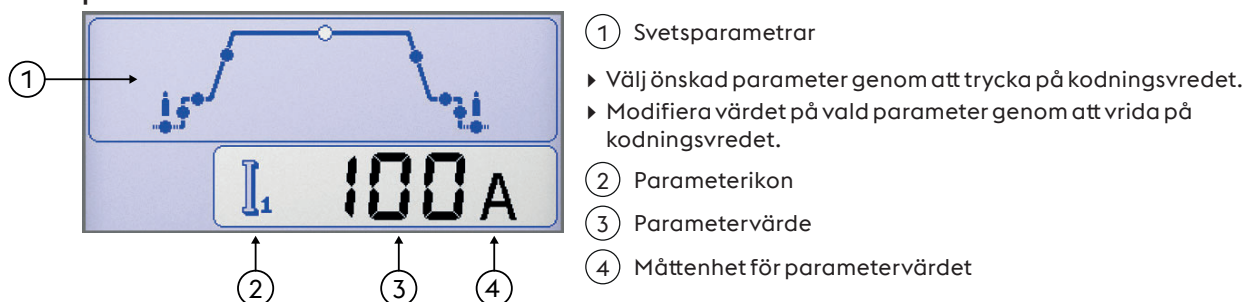

Funktioner

Medger inställning av de viktigaste processfunktionerna och svetsmetoderna.

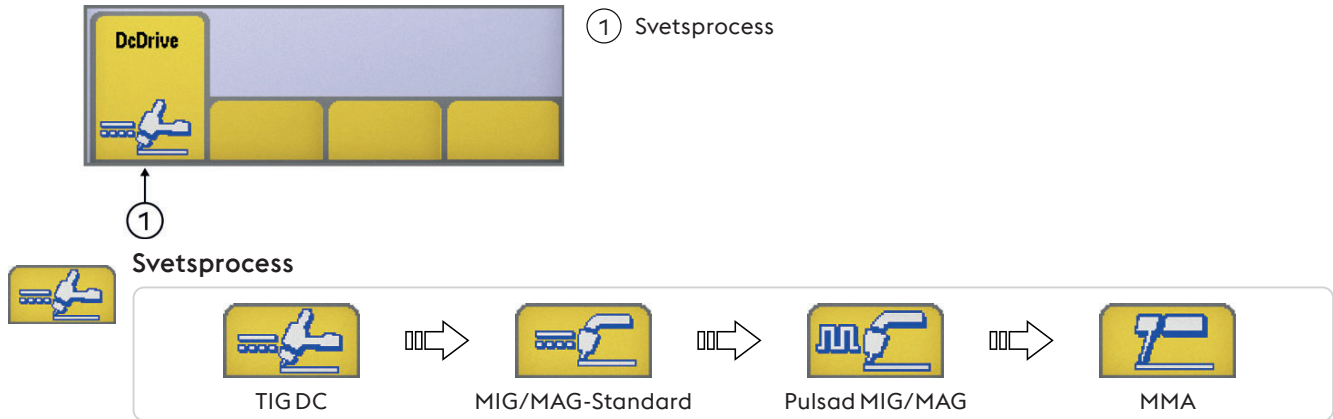

4.6 Huvudskärmbild för MIG/MAG-process

Grundskärmbild

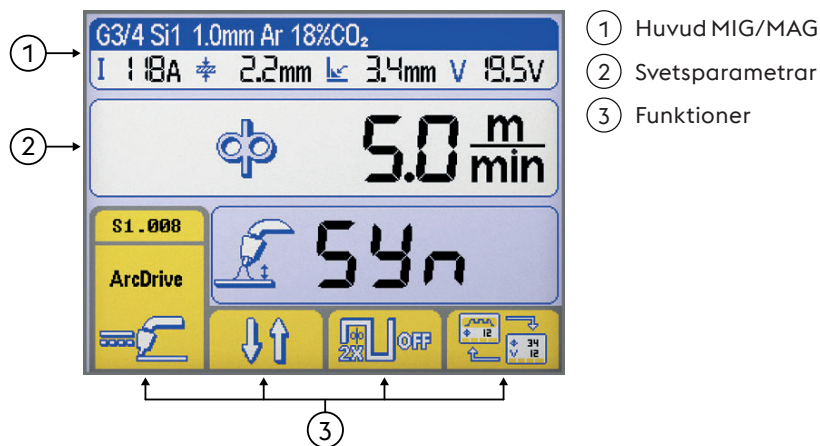

Grafisk skärmbild

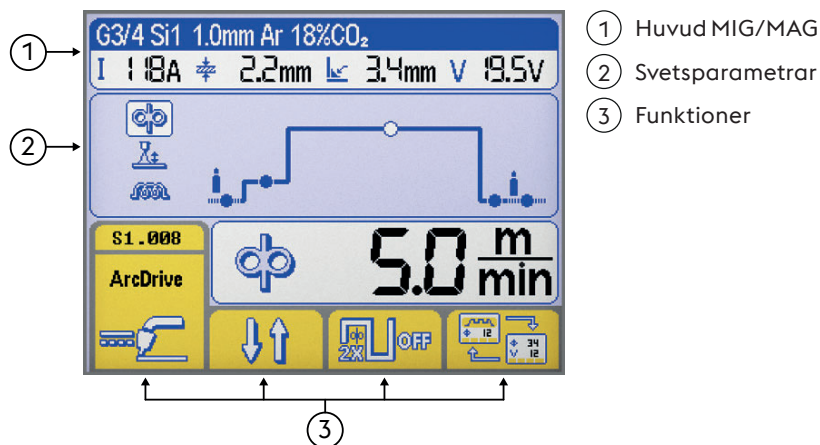

Huvud MIG/MAG

Visar vissa viktiga uppgifter i relation till den valda processen.

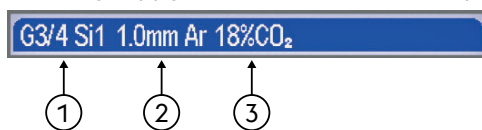

Vald synergikurva

- ① Typ av svetstråd
- ② Wtråddiameter
- ③ Typ av gas

SV



Svetsparametrar

- ① Svetsström
- ② Ämnestjocklek
- ③ Hörnfog
- ④ arbetsspänning

Svetsparametrar (Grundskärmbild)

► Välj önskad parameter genom att trycka på kodningsvredet.

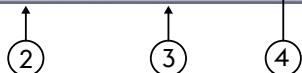
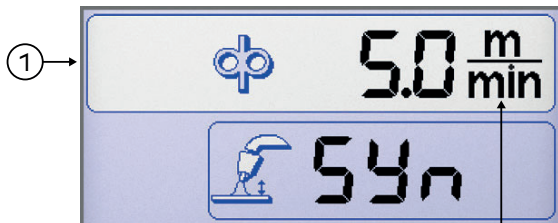

- ① Svetsparametrar
- ② Parameterikon
- ③ Parametervärde
- ④ Måttenhet för parametervärdet

Svetsparametrar (Grafisk skärmbild)

► Välj önskad parameter genom att trycka på kodningsvredet.

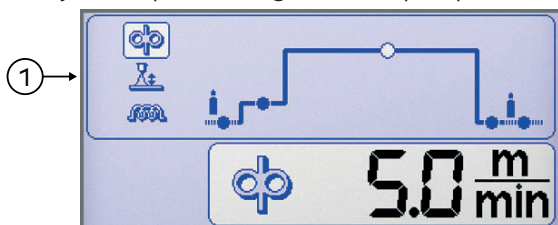

- ① Svetsparametrar
- ② Parameterikon
- ③ Parametervärde
- ④ Måttenhet för parametervärdet

Funktioner

Medger inställning av de viktigaste processfunktionerna och svetsmetoderna.

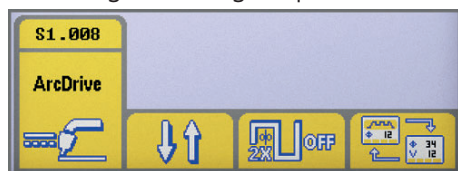

- ① Svetsprocess
- ② Svetsmetoder
- ③ Dubbelpuls
- ④ Skärmbild



Svetsprocess

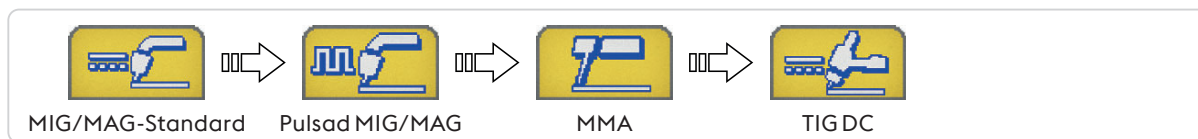

Svetsmetoder

Medger val av svetsmetod



2 steg

När knappen trycks in börjar gasen att flöda, matar spänning till tråden så att den matas fram; när knappen släpps stängs gasen, spänningen och trådmatningen av.



4 steg

Den första knapptryckningen får gasen att flöda med en manuell förgastid. När knappen sedan släpps aktiveras spänningen till tråden och trådmatningen. Följande knapptryckning stannar tråden och startar den slutliga processen där strömmen återgår till noll. När knappen släpps till sist stängs gasflödet av.



Crater filler

Möjliggör svetsning med tre olika effektnivåer som kan väljas direkt med brännarknappen. Den första knapptryckningen får gasen att flöda, aktiverar spänningen till tråden och matar den med inställd hastighet och med de aktuella synergivärdena från svetsparametrarna. När du släpper brännarknappen ändras trådshastigheten och de aktuella synergiparametrarna automatiskt till de grundvärden som är inställda på kontrollpanelen. Nästa gång du trycker på knappen ställs trådshastigheten och de aktuella synergiparametrarna in på de förinställda parametervärdena för kraterfyllning. När du släpper brännarknappen avbryts trådmatningen och det matas ström till burn back- och eftergasstegen.



Dubbelpuls



Dubbelpuls aktiv



Dubbelpuls inaktiv



Skärmbild

Växlar mellan att visa följande:



Grundskärmbild



Grafisk skärmbild

Skärm med synergikurvor



Synergi

Medger val av förinställt svetsprogram (synergi) genom att välja några enkla inställningar

Val av svetsprocess

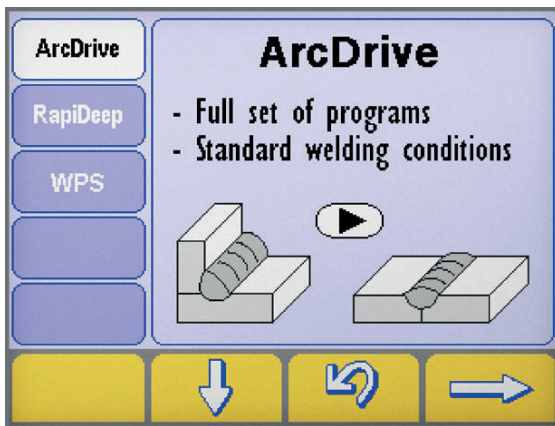

- ▶ Gå till skärmbilden "synergier" genom att trycka på knappen i minst 1 sekund.
- ▶ Välj önskad process genom att trycka på knapparna e .
- ▶ Tryck på knappen för att gå till nästa steg.



Skärmbild för val av synergi Typ av material/Typ av gas

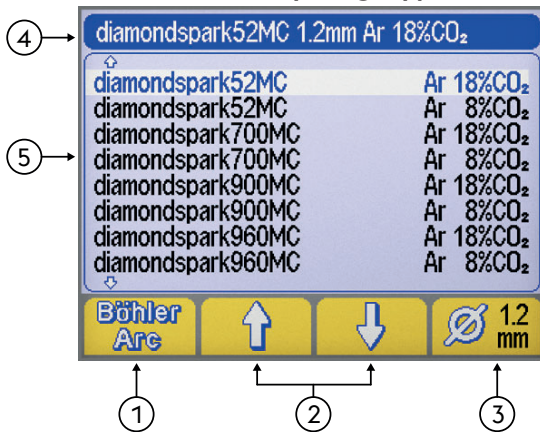

- 1 Svetsprogram (BöhlerArc/UniversalArc)
- 2 Val av material/gas
- 3 Wtråddiameter
- 4 Huvud
- 5 Svetsprogram



Svetsprogram

Medger val av svetsprogram



BöhlerArc



UniversalArc



Val av material/gas

Medger val av:



- Typ av svetstråd
- Typ av gas

Wtråddiameter

Kan man välja tråddiameter (mm).

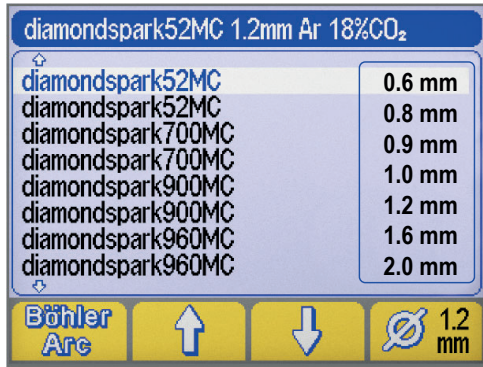

① Wtråddiameter

①

Huvud

Visar vissa viktiga uppgifter i relation till den valda processen.



NO PROGRAM

Indikerar att det valda synergiprogrammet inte är tillgängligt eller inte är kompatibelt med de övriga systeminställningarna.

4.7 programvalsskärmen

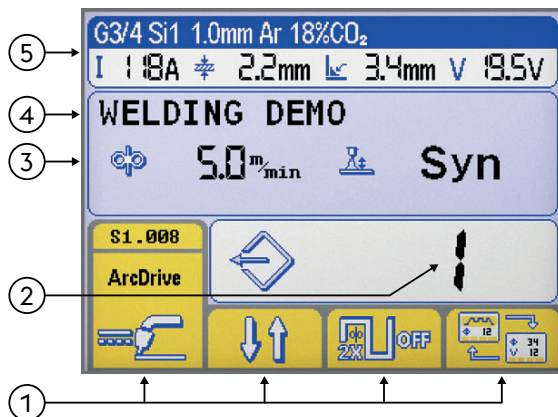

Medger lagring och hantering av 240 svetsprogram som kan anpassas till den enskilda användaren.

Program (JOB)

① Funktioner

② Numret på det valda programmet

③ Huvudparametrar i det valda programmet

④ Beskrivning av det valda programmet

⑤ Huvud

Se avsnittet "Huvudskärmen"

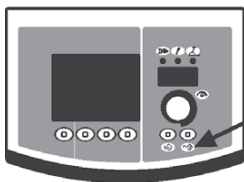
Programlagring



► Gå till programlagringsmenyn genom att hålla in knappen  i minst 1 sekund.



► Välj önskat program (eller tomt minne) genom att vrida på kodningsvredet.

--- Minnet tomt



 **Programmet sparat**

► Bekräfta åtgärden genom att trycka på knappen .

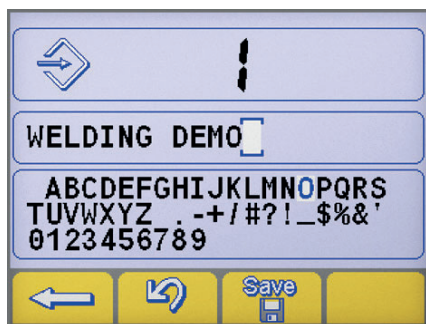
► Spara alla aktuella inställningar till det valda programmet genom att trycka på knappen. .





Lägg in en beskrivning av programmet.

- ▶ Välj önskad bokstav genom att vrida på kodningsvredet.
- ▶ Spara vald bokstav genom att trycka på kodningsvredet.
- ▶ Ta bort den sista bokstaven genom att trycka på knappen .
- ▶ Bekräfta åtgärden genom att trycka på knappen .
- ▶ Bekräfta åtgärden genom att trycka på knappen .



 Om man vill spara ett nytt program på en minnesplats som redan är full måste man radera platsen genom en obligatorisk metod.

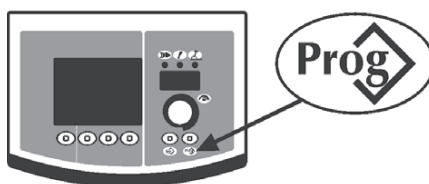

- ▶ Bekräfta åtgärden genom att trycka på knappen .
- ▶ Ta bort det valda programmet genom att trycka på knappen .
- ▶ Fortsätt med lagringsmetoden.

Hämtning av program





- ▶ Hämta det första tillgängliga programmet genom att trycka på knappen .
- ▶ Välj önskat program genom att vrida på kodningsvredet.
- ▶ Välj önskat program genom att trycka på knappen .



 Endast de minnesplatser där program är sparade hämtas medan tomma plaster automatiskt hoppas över.

Radering av program

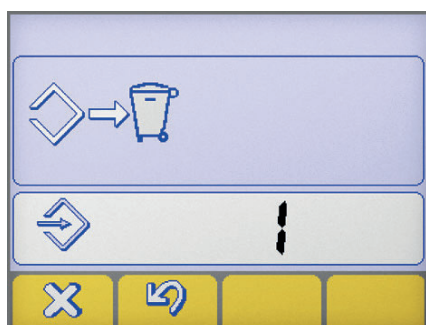

- ▶ Välj önskat program genom att vrida på kodningsvredet.
- ▶ Ta bort det valda programmet genom att trycka på knappen .
- ▶ Bekräfta åtgärden genom att trycka på knappen .



- ▶ Bekräfta åtgärden genom att trycka på knappen .
- ▶ Ta bort det valda programmet genom att trycka på knappen .

5. SETUP

5.1 Set-up och ställa in parametrar

För inställning av en rad tilläggsparametrar som ger en bättre och mer precis hantering av svetsanläggningen. De set-upparametrar som visas är anpassade efter den valda svetsningen och har numeriska koder.

Att öppna set-up





- ▶ Tryck på encoderknappen i 5 sekunder.
- ▶ Åtkomsten bekräftas av att det står 0 på displayen.

Att välja och ställa in önskad parameter

- ▶ Tryck på dataomvandlaren tills den numeriska koden för den önskade parametern visas.
- ▶ Tryck sedan på dataomvandlarknappen för att visa det inställda värdet för den valda parametern och ändra inställningen.

Att stänga set-up

- ▶ Tryck på dataomvandlaren igen för att gå ur "inställningssektionen".
- ▶ Gå till parametern "0" (spara och stäng) och tryck på dataomvandlarknappen för att gå ur set-up.
- ▶ Bekräfta åtgärden genom att trycka på knappen .
- ▶ Spara ändringen och gå ur set-up genom att trycka på knappen: .

5.1.1 Set-upparametrar (MMA)

0

Spara och stäng

För att spara ändringarna och gå ur set-up.



1

Återställning

För att återställa alla parametrarna till standardvärdena.



3

Hot start

För inställning av hot start-procenten vid MMA-svetsning.

För inställning av mer eller mindre "het" start för att underlätta tändningen av bågen.



Basisk elektrode

Minimum	Maximum	Standard
0/af	500%	80%

Cellulose elektrode

Minimum	Maximum	Standard
0/af	500%	150%

CrNi-elektrode

Minimum	Maximum	Standard
0/af	500%	100%

Aluminium elektrode

Minimum	Maximum	Standard
0/af	500%	120%

Gjutjärn elektrode

Minimum	Maximum	Standard
0/af	500%	100%

7

Svetsström

För inställning av svetsströmmen.

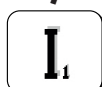

Minimum	Maximum	Standard
3 A	I _{max}	100 A

8

Arc force



För inställning av arc force-procenten vid MMA-svetsning.
Ger ett mer eller mindre energirikt dynamiskt svar under svetsningen för att underlätta svetsarens arbete.
Ökning av bågeffekten minskar risken för att elektroden ska fastna.

Basisk elektrode

Minimum	Maximum	Standard
0/af	500%	30%

Cellulose elektrode

Minimum	Maximum	Standard
0/af	500%	350%

CrNi-elektrode

Minimum	Maximum	Standard
0/af	500%	30%

Aluminium elektrode

Minimum	Maximum	Standard
0/af	500%	100%

Gjutjärn elektrode

Minimum	Maximum	Standard
0/af	500%	70%

204

Dynamic power control (DPC)



Möjliggör val av önskad V/I-karakteristik.

I=C Konstantström

Ökning eller minskning av båg höjden har ingen effekt på den svetsström som krävs.

Rekommenderas för elektrod: Basisk, Rutil, Sur, Stål, Gjutjärn

1:20 Minskande gradientkontroll

Ökningen av båg höjden orsakar en sänkning av svetsströmmen (och omvänt) enligt det värde som ges av 1 till 20 ampere per volt.

Rekommenderas för elektrod: Cellulosa, Aluminium

P=C Konstanteffekt

Ökningen av båg höjden orsakar en sänkning av svetsströmmen (och omvänt) enligt formeln: $V \cdot I = K$

Rekommenderas för elektrod: Cellulosa, Aluminium

312

Spänning för att bryta bågen



För inställning av det spänningsvärde vid vilket den elektriska bågen ska brytas.

Används för att hantera de olika driftförutsättningar som uppstår på bästa sätt.

Vid punktsvetsning blir till exempel den uppflammande lågan när elektroden tas bort från arbetsstycket mindre om bågen bryts vid en låg spänning, vilket innebär att det blir mindre stänk, brännskador och oxidation på arbetsstycket.

Om du använder elektroder som fordrar hög spänning bör du däremot ställa in en hög tröskel för att undvika att bågen släcks under svetsningen.



Ställ aldrig in en högre spänning för att bryta bågen än generatorns tomgångsström.

Basisk elektrode

Minimum	Maximum	Standard
0/af	99.9 V	57.0 V

Cellulose elektrode

Minimum	Maximum	Standard
0/af	99.9 V	70.0 V

399

Skärningshastighet



Medger inställning av svetsningshastighet.

Default cm/min: referenshastighet för manuell svetsning.

Syn: Sinergic värde.

Minimum	Maximum	Standard
1 cm/min	200 cm/min	15 cm/min

500

Maskininställning



Här kan man välja grafiskt gränssnitt.

Ger åtkomst till de högre inställningsnivåerna.

Se avsnittet "Anpassning av gränssnittet (Set up 500)"

Värde	Användargränssnitt
XE	Driftsättet Easy
XA	Driftsättet Advanced
XP	Driftsättet Professional

Värde	Vald nivå
USER	Användare
SERV	Service
vaBW	vaBW

551 Lock/unlock

Medger spärning av manöverpanelen och inmatning av en skyddskod.
 Se avsnittet "Lock/unlock (Set up 551)".

552 Ljudsignal

För inställning av ljudsignalen.

Minimum	Maximum	Standard
0/af	10	10

601 Inställningssteg

Medger inställning av en parameter med ett steg som användaren kan bestämma själv.

Minimum	Maximum	Standard
1	Imax	1

602 Extern parameter CH1, CH2, CH3, CH4

Här kan man ställa in den externa parametern 1, 2, 3, 4 (minsta värde, största värde, förinställt värde, vald parameter).

Se avsnittet "Hantering av externa styrkommandon (Set up 602)".

705 Kalibrering av kretsmotstånd

Används för kalibrering av aggregatet.

Se avsnittet "Kalibrering av kretsmotstånd (set up 705)".

751 Strömstyrka

Medger visning av den faktiska svetsströmmen.

752 Spänning

Medger visning av den faktiska svetsspänningen.

768 Mätning av värmetillskott HI

Används för avläsning av mätvärdet för värmetillskott vid svetsningen.

5.1.2 Lista över inställda parametrar (TIG)
0 Spara och stäng

För att spara ändringarna och gå ur set-up.

1 Återställning

För att återställa alla parametrarna till standardvärdena.

7 Svetsström

För inställning av svetsströmmen.

Minimum	Maximum	Standard
3 A	Imax	100 A

399 Skärningshastighet

Medger inställning av svetsningshastighet.

Default cm/min: referenshastighet för manuell svetsning.

Syn: Sinergic värde.

Minimum	Maximum	Standard
1 cm/min	200 cm/min	10 cm/min

500 Maskininställning



Här kan man välja grafiskt gränssnitt.
Ger åtkomst till de högre inställningsnivåerna.
Se avsnittet "Anpassning av gränssnittet (Set up 500)"

Värde	Användargränssnitt
XE	Driftsättet Easy
XA	Driftsättet Advanced
XP	Driftsättet Professional

Värde	Vald nivå
USER	Användare
SERV	Service
vaBW	vaBW

551 Lock/unlock



Medger spärning av manöverpanelen och inmatning av en skyddskod.
Se avsnittet "Lock/unlock (Set up 551)".

552 Ljudsignal



För inställning av ljudsignalen.

Minimum	Maximum	Standard
0/af	10	10

601 Inställningssteg



Medger inställning av en parameter med ett steg som användaren kan bestämma själv.

Minimum	Maximum	Standard
1	Imax	1

602 Extern parameter CH1, CH2, CH3, CH4



Här kan man ställa in den externa parametern 1, 2, 3, 4 (minsta värde, största värde, förinställt värde, vald parameter).

Se avsnittet "Hantering av externa styrkommandon (Set up 602)".

705 Kalibrering av kretsmotstånd



Används för kalibrering av aggregatet.
Se avsnittet "Kalibrering av kretsmotstånd (set up 705)".

751 Strömstyrka



Medger visning av den faktiska svetsströmmen.

752 Spänning



Medger visning av den faktiska svetsspänningen.

755 Avläsning av gasflödet (WFR)



Det faktiska gasflödet kan läsas av.

757 Tråd hastighet



Visar värdet för motorkodare 1.

760 Strömstyrka (motor 1)



Medger visning av den faktiska motorströmmen (motor 1).

764 Kylmedelsflöde



Medger visning av den kylmedelsflöde.

765 Avläsning kylmedelstemperatur
 Medger visning av den kylmedelstemperatur.



768 Mätning av värmetillskott HI
 Används för avläsning av mätvärdet för värmetillskott vid svetsningen.



801 Säkerhetsgränser
 Medger inställning av varnings- och säkerhetsgränser.
 Medger styrning av svetsprocessen med hjälp av varningsgränser och säkerhetsgränser för de viktigaste mätbara parametrarna.
 För noggrann styrning av de olika svetsfaserna
 Se avsnittet "Säkerhetsgränser (Set up 801)".





5.1.3 Lista över inställda parametrar (MIG/MAG)

0 Spara och stäng
 För att spara ändringarna och gå ur set-up.



1 Återställning
 För att återställa alla parametrarna till standardvärdena.



2 Synergi
MIG/MAG-Standard:
 Gör att man kan välja den manuella () eller synergiska () MIG-processen genom att ställa in vilken typ av material som ska svetsas.
Pulsad MIG/MAG:
 Gör att man kan välja synergiska () MIG-processen genom att ställa in vilken typ av material som ska svetsas.
 Gör att man kan välja den CC/CV-processen.



3 Trådastighet
 Medger inställning av trådmatningshastigheten.

Minimum	Maximum	Standard
0.5 m/min	22.0 m/min	-



4 Ström
 För inställning av svetsströmmen.

Minimum	Maximum
3 A	Imax



5 Ämnestjocklek
 Medger inställning av godstjockleken i arbetsstycket.
 Systemet anpassas till arbetsstycket.



6 Hörnfog "a"
 Medger inställning av fogdjup i hörn.



7

Spänning - båglängd



Medger inställning av svetsspänning.
Medger inställning av båglängden vid svetsning.
Hög spänning = lång båge
Låg spänning = kort båge

Manuellsvetsning

Minimum	Maximum	Standard
5.0 V	55.5 V	5.0 V

10

För-gas



För att ställa in och reglera gasflödet innan bågen tänds.
Gör det möjligt att ladda gasen i brännaren och förbereda miljön för svetsningen.

Minimum	Maximum	Standard
0/af	99.9 s	0.1 s

11

Soft start



Gör det möjligt att ställa in trådmatningshastigheten i skedena före tändningen.
Medger tändning med reducerad hastighet, som därmed blir mjukare och ger mindre stänk.

Minimum	Maximum	Standard
10 %	100 %	50 %

12

Motorramp



För inställning av en stegvis övergång mellan trådmatningshastigheten vid tändningen och under svetsningen.

Minimum	Maximum	Standard
0/af	1.0 s	0/af

15

Burn back

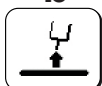

Gör det möjligt att ställa in trådens bränntid och förhindra att den fastnar efter svetsningen.
Gör det möjligt att reglera längden på den del av tråden som befinner sig utanför brännaren.

Minimum	Maximum	Standard
-2.00	+2.00	0/syn

16

Efter-gas



För inställning av gasflödet vid slutet av svetsningen.

Minimum	Maximum	Standard
0/af	99.9 s	2.0 s

19

Duty cycle (dubbelpulsad)

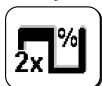

Tillåt justering av driftcykeln i dubbelpulsat läge.

Minimum	Maximum	Standard
10 %	90 %	50 %

20

Dubbelpuls



Pulsamplituden kan ställas in.

Minimum	Maximum	Standard
0 %	100 %	±25 %

Minimum	Maximum	Standard
0.5 m/min	22 m/min	2.5 m/min

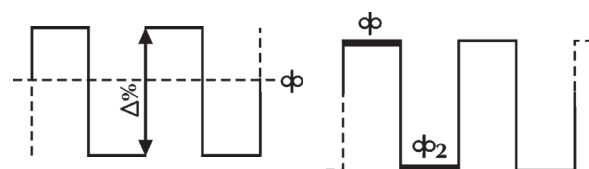

21

Pulsfrekvens (dubbelpulsad)



Medger inställning av cykeln, alltså pulsupprepningen.
Pulsfrekvensen kan ställas in.

Minimum	Maximum	Standard
0.1 Hz	5.0 Hz	2.0 Hz

SV

22 Sekundärspänning (dubbelpulsad)

Medger inställning av spänningen för sekundärpulserna.
 Det går att få en stabilare båge under de olika faserna i pulscykeln.

Minimum	Maximum	Standard
-5.0	+5.0	0/syn

23 Pulsramper (dubbelpulsad)

Inställning av stegrings- eller minskningstid under pulsdraft.

Minimum	Maximum	Standard
1 %	100 %	50 %

24 Bilevel (4T - crater filler)

För inställning av sekundärtrådmatningshastighet vid bilevel-svetsning.

Om man trycker på knappen och snabbt släpper den igen övergår strömmen till “ ϕ_2 ”.

Tryck på knappen och släpp den genast för att gå tillbaka till “ ϕ ”, och vice versa för.

Minimum	Maximum	Standard
1 %	200 %	0/af

25 Startstöt

Medger inställning av trådmatningshastigheten under den första svetsfasen med “kraterfyllning”.

Energitillförseln till arbetsstycket kan ökas när materialet fortfarande är kallt och behöver mer ström för att smälta i jämn takt.

Minimum	Maximum	Standard
20 %	200 %	120 %

26 Crater filler

Medger inställning av trådmatningshastigheten under den avslutande svetsfasen med “kraterfyllning”.

Strömmen kan reduceras under den fas när materialet är kraftigt upphettat, vilket minskar risken för oönskade deformationer.

Minimum	Maximum	Standard
20 %	200 %	80 %

27 Första stegringstid

Medger inställning av första stegringstid.

Medger automatisering av kraterfyllningsfunktionen.

Minimum	Maximum	Standard
0.1 s	99.9 s	0/af

28 Kraterfyllningstid

Medger inställning av kraterfyllningstid.

Medger automatisering av kraterfyllningsfunktionen.

Minimum	Maximum	Standard
0.1 s	99.9 s	0/af

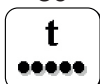
30 Punktsvetsning

Gör att du kan aktivera punktsvetsningsprocessen och bestämma svetsningstiden.

Minimum	Maximum	Standard
0.1 s	99.9 s	0/af

31 Punktsvetsning med pauser

För inkoppling av punktsvetsning med pauser och inställning av paustiden mellan svetsningarna.

Minimum	Maximum	Standard
0.1 s	99.9 s	0/af



32 Sekundärspänning (Bilevel MIG)

Medger inställning av spänningen för sekundärpulserna.
Det går att få en stabilare båge under de olika faserna i pulsnyckeln.

Minimum	Maximum	Standard
-5.0	+5.0	0/syn

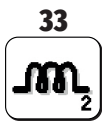

33 Sekundärinduktans (Bilevel MIG)

Medger inställning av induktans för sekundärpulserna.
Bågen kan på så sätt göras snabbare eller långsammare för att kompensera för svetsarens rörelser och för den naturliga instabiliteten i svetsförloppet.
Låg induktans = reaktiv båge (mer stänk).
Hög induktans = mindre reaktiv båge (mindre stänk).

Minimum	Maximum	Standard
-30	+30	0/syn



34 Initial ökningsramp

Används för att ställa in en gradvis övergång från den initiala trådhastigheten till svetsningshastigheten.

Minimum	Maximum	Standard
0 s	10 s	0/af



35 Kraterfyllningsramp

Används för att ställa in en gradvis övergång från svetsningshastigheten till kraterfyllningshastigheten.

Minimum	Maximum	Standard
0 s	10 s	0/af



202 Induktans

Medger elektronisk inställning av svetskretsens serieinduktans.
Bågen kan på så sätt göras snabbare eller långsammare för att kompensera för svetsarens rörelser och för den naturliga instabiliteten i svetsförloppet.
Låg induktans = reaktiv båge (mer stänk).
Hög induktans = mindre reaktiv båge (mindre stänk).

Minimum	Maximum	Standard
-30	+30	0/syn



331 Kompenserad medelspänning

Medger inställning av svetsspänning.



399 Skärningshastighet

Medger inställning av svetsningshastighet.
Default cm/min: referenshastighet för manuell svetsning.
Syn: Sinergic värde.

Minimum	Maximum	Standard
syn min	syn max	35 cm/min



500 Maskininställning

Här kan man välja grafiskt gränssnitt.
Ger åtkomst till de högre inställningsnivåerna.
Se avsnittet "Anpassning av gränssnittet (Set up 500)"

Värde	Användargränssnitt
XE	Driftsättet Easy
XA	Driftsättet Advanced
XP	Driftsättet Professional

Värde	Vald nivå
USER	Användare
SERV	Service
vaBW	vaBW



551 Lock/unlock

Medger spärning av manöverpanelen och inmatning av en skyddskod.
Se avsnittet "Lock/unlock (Set up 551)".

552 Ljudsignal

För inställning av ljudsignalen.

Minimum	Maximum	Standard
0/af	10	10

601 Inställningssteg

Medger inställning av en parameter med ett steg som användaren kan bestämma själv. Funktionalitet som styrs av upp / ner-knappen.

Minimum	Maximum	Standard
1	Imax	1

602 Extern parameter CH1, CH2, CH3, CH4

Här kan man ställa in den externa parametern 1, 2, 3, 4 (minsta värde, största värde, förinställt värde, vald parameter).

Se avsnittet "Hantering av externa styrkommandon (Set up 602)".

606 U/D-brännare

Här kan man ställa in den externa parametern (U/D).

Värde	Standard	Återuppringningsfunktion
0/af	-	af
1/I1	X	Ström
	-	Hämtning av program

705 Kalibrering av kretsmotstånd

Används för kalibrering av aggregatet.

Se avsnittet "Kalibrering av kretsmotstånd (set up 705)".

751 Strömstyrka

Medger visning av den faktiska svetsströmmen.

752 Spänning

Medger visning av den faktiska svetsspänningen.

755 Avläsning av gasflödet (WFR)

Det faktiska gasflödet kan läsas av.

757 Tråd hastighet

Visar värdet för motorkodare 1.

758 Robothastighet

Medger avläsning av hur fort armen på en robot eller en automatiserad enhet rör sig.

760 Strömstyrka (motor 1)

Medger visning av den faktiska motorströmmen (motor 1).

761 Tråd hastighet

Visar värdet för motorkodare 2.

762 Strömstyrka (motor 2)
Medger visning av den faktiska motorströmmen (motor 2).



763 Tråd hastighet
Visar tråd hastighetens faktiska värde.



764 Kylmedelsflöde
Medger visning av den kylmedelsflöde.



765 Avläsning kylmedelstemperatur
Medger visning av den kylmedelstemperatur.



768 Mätning av värmestillskott HI
Används för avläsning av mätvärdet för värmestillskott vid svetsningen.



801 Säkerhetsgränser
Medger inställning av varnings- och säkerhetsgränser.
Medger styrning av svetsprocessen med hjälp av varningsgränser och säkerhetsgränser för de viktigaste mätbara parametrarna.
För noggrann styrning av de olika svetsfaserna
Se avsnittet "Säkerhetsgränser (Set up 801)".



5.2 Särskilda procedurer för användning av parametrar

5.2.1 Anpassning av 7-segmentsdisplayen

Används för att visa ett parametervärde konstant på 7-segmentsdisplayen.

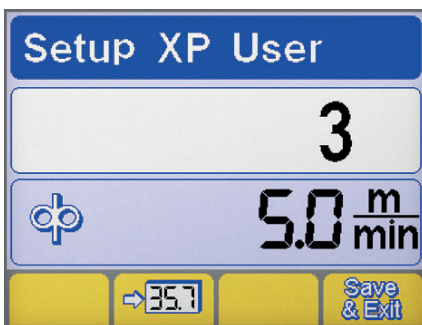

- ▶ Gå till SetUp genom att hålla kodningsvredet intryckt under minst 5 sekunder.
- ▶ Välj önskad parameter genom att vrida på kodningsvredet.
- ▶ Lagra den valda parametern i 7-segmentsdisplayen genom att trycka på knappen .
- ▶ Spara och lämna skärmen genom att trycka på knappen .

5.2.2 Anpassning av gränssnittet (Set up 500)

Parametrarna kan anpassas i huvudmenyn.

500 Maskininställning
Här kan man välja grafiskt gränssnitt.



Värde	Användargränssnitt
XE	Driftsättet Easy
XA	Driftsättet Advanced
XP	Driftsättet Professional

DRIFTSÄTT XE

MMA	
Svetsparametrar	
TIG	
Svetsparametrar	
Funktioner	
MIG/MAG	
Svetsparametrar	
Funktioner	

DRIFTSÄTT XA

MMA	
Svetsparametrar	
Funktioner	
TIG	
Svetsparametrar	
Funktioner	
MIG/MAG	
Svetsparametrar	
Funktioner	

SV

DRIFTSÄTT XP

MMA	
Svetsparametrar	
Funktioner	
TIG	
Svetsparametrar	
Funktioner	

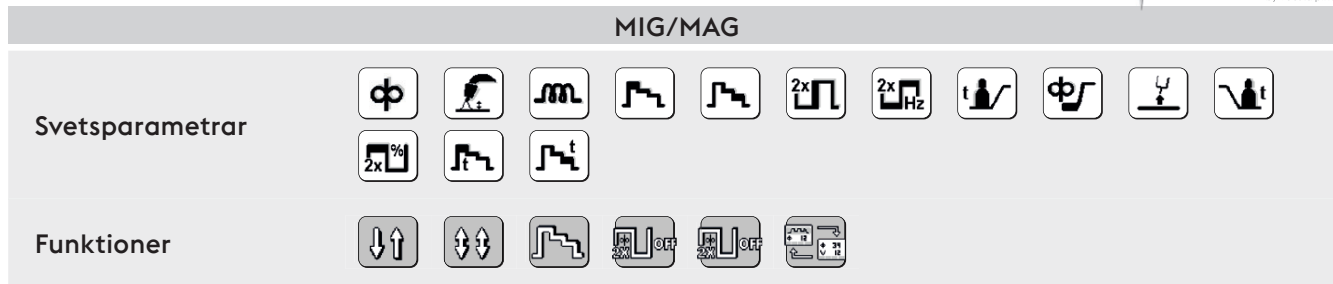

5.2.3 Lock/unlock (Set up 551)

Medger spärning av manöverpanelen och inmatning av en skyddskod.

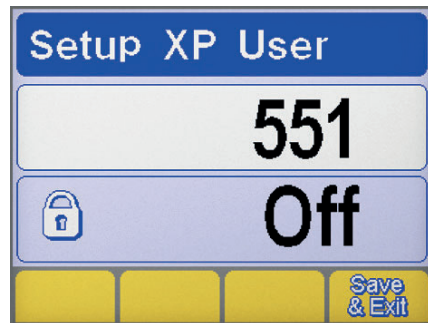

Val av parameter

- ▶ Gå till SetUp genom att hålla kodningsvredet intryckt under minst 5 sekunder.
- ▶ Välj parameter (551).
- ▶ Aktivera inställning av vald parameter genom att trycka på kodningsknappen.

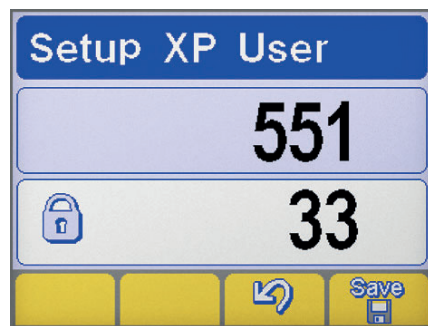

- ▶ Ställ in en numerisk kod (ett lösenord) genom att vrida på kodningsvredet.
- ▶ Bekräfta momentet genom att trycka på encoderknappen.
- ▶ Bekräfta åtgärden genom att trycka på knappen .
- ▶ Spara ändringen genom att trycka på knappen: .

Panelfunktioner



Om man försöker göra någon åtgärd via en spärrad manöverpanel visas en specialsärm.

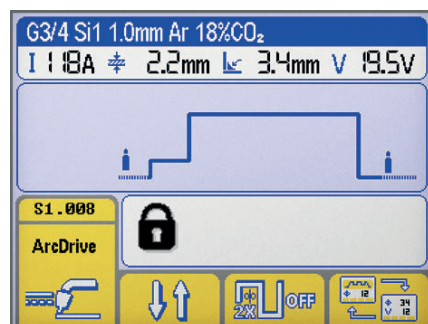

- ▶ Gå till panelfunktionerna tillfälligt (under 5 minuter) genom att vrida på kodningsvredet och mata in lösenordet (koden).
- ▶ Bekräfta momentet genom att trycka på encoderknappen.
- ▶ Manöverpanelen frisläpps permanent om man går till Set-up (se anvisningarna ovan) och ändrar parameter 551 till OFF.
- ▶ Bekräfta momentet genom att trycka på encoderknappen.
- ▶ Spara ändringen genom att trycka på knappen: .

5.2.4 Hantering av externa styrkommandon (Set up 602)

Här kan man ställa in den externa parametern 2 (minsta värde, största värde, förinställt värde, vald parameter).

Val av parameter

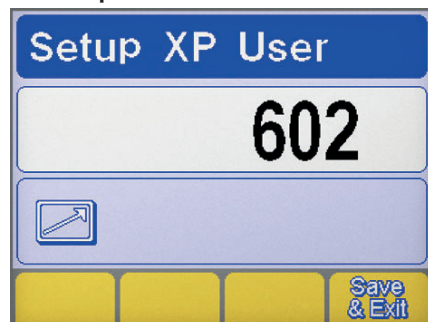

- ▶ Gå till SetUp genom att hålla kodningsvredet intryckt under minst 5 sekunder.
- ▶ Välj parameter (602).
- ▶ Gå till skärmen "Hantering av externa styrkommandon" genom att trycka på kodningsvredet.

SV

Hantering av externa styrkommandon

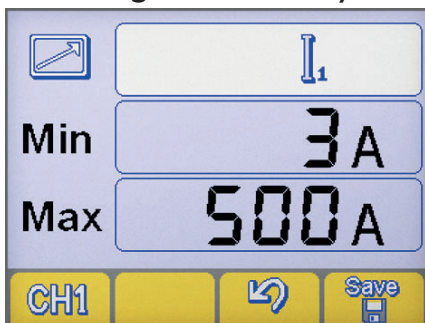

- ▶ Välj RC-fjärrkontrollutgång (CH1, CH2, CH3, CH4) genom att trycka på knappen:
- ▶ Välj önskad parameter (MIN-MAX-parameter) genom att trycka på kodningsvredet.
- ▶ Ställ in värdet på önskad parameter (MIN-MAX-parameter) genom att vrida på kodningsvredet.
- ▶ Spara ändringen genom att trycka på knappen:
- ▶ Bekräfta åtgärden genom att trycka på knappen

5.2.5 Kalibrering av kretsmotstånd (set up 705)

Används för att kalibrera generatort utifrån den aktuella svetskretsens motstånd.

Val av parameter

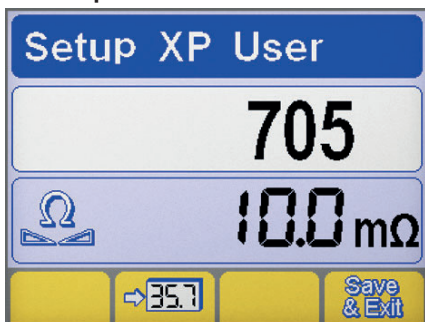

- ▶ Gå till SetUp genom att hålla kodningsvredet intryckt under minst 5 sekunder.
- ▶ Välj parameter (705).
- ▶ Aktivera inställning av vald parameter genom att trycka på kodningsknappen.
- ▶ Anslut generatort till svetskretsen (arbetsbord eller arbetsstycke).
- ▶ Ta bort hättan för att montera munstyckeshållarens spets på brännaren. (MIG/MAG)

Kalibrering

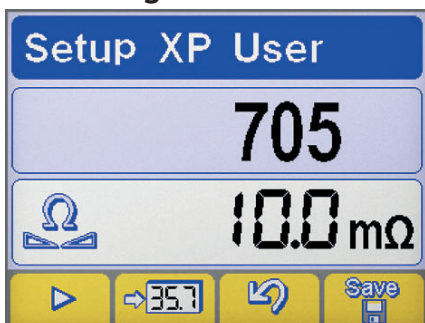

- ▶ Sätt trådguidens spets i elektrisk kontakt med arbetsstycket. (MIG/MAG)
- ▶ Tryck på knappen för att börja proceduren.
- ▶ Upprätthåll kontakten i minst 1 sekund.
- ▶ Värdet som visas på displayen uppdateras efter kalibreringen.
- ▶ Bekräfta åtgärden genom att trycka på knappen
- ▶ Bekräfta åtgärden genom att trycka på knappen
- ▶ Spara ändringen och gå ur set-up genom att trycka på knappen:

5.2.6 Säkerhetsgränser (Set up 801)

Medger inställning av varnings- och säkerhetsgränser.

Medger styrning av svetsprocessen med hjälp av varningsgränser och säkerhetsgränser för de viktigaste mätbara parametrarna.

För noggrann styrning av de olika svetsfaserna

Uppmärksamhetsgränser				Säkerhetsgränser			
	Svetsström						
	Avläsning av gasflödet						
	Strömstyrka (motor 1)						
	Kylmedelsflöde						
	Avläsning kylmedelstemperatur						

Val av parameter

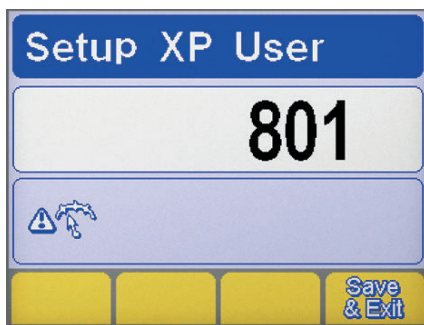

- ▶ Gå till SetUp genom att hålla kodningsvredet intryckt under minst 5 sekunder.
- ▶ Välj parameter (801).
- ▶ Gå till skärmen "Säkerhetsgränser" genom att trycka på kodningsvredet.

Val av parametern

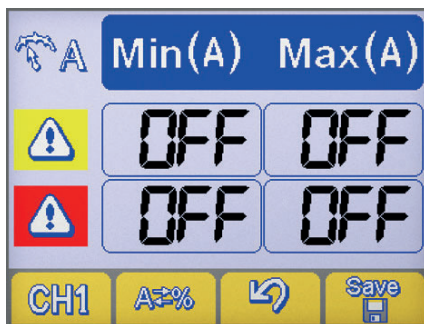

- ▶ Välj önskad parameter genom att trycka på knappen **CH1**.
- ▶ Välj metod för inställning av säkerhetsgränserna genom att trycka på knappen **A=%**.

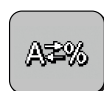

Maskininställning



Absolutvärde



Procentvärde

Inställning av larmgränser

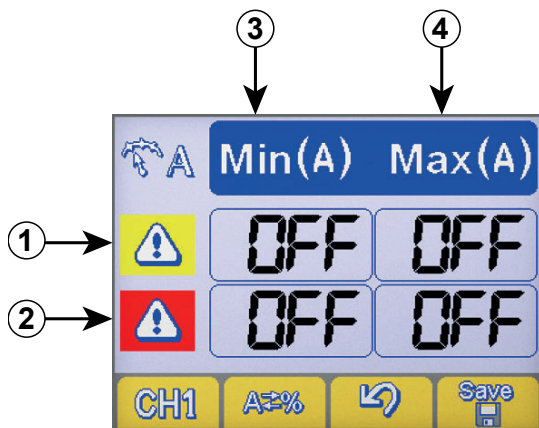

- ① Rad för varningsgränser
- ② Rad för larmgränser
- ③ Spalt för lägsta nivå
- ④ Spalt för högsta nivå

- ▶ Välj önskat fält genom att trycka på kodningsvredet (det valda fältet markeras genom omvänd kontrast).
- ▶ Modifiera värdet på den valda gränsen genom att vrida på kodningsvredet.
- ▶ Spara ändringen genom att trycka på knappen: **Save**.



När en varningsgräns passeras avges en visuell varning på manöverpanelen.



När en larmgräns passeras visas ett visuellt larm på manöverpanelen och svetsprocessen avbryts.



Man kan ställa in filter för tändningen och släckningen av ljusbågen så att inga larm avges då (se avsnittet "Set Up" - Parametrarna 802-803-804).

SV

6. UNDERHÅLL



Anläggningen ska genomgå löpande underhåll i enlighet med tillverkarens instruktioner. Alla luckor och kåpor ska vara stängda och ordentligt fastsatta när apparaten är i drift. Aggregatet får inte modifieras på något sätt. Om detta underhåll inte utförs upphör alla garantier att gälla och tillverkaren kan inte utkrävas något ansvar för konsekvenserna.



Eventuellt underhåll får endast utföras av utbildad personal. Om obehörig personal reparerar aggregatet eller byter ut delar av det upphör produktgarantin omedelbart att gälla. Eventuella reparationer och utbyte av delar av aggregatet får endast utföras av kompetent teknisk personal.



Stäng av strömförsörjningen till aggregatet före alla ingrepp!

6.1 Periodiska kontroller av generatorn

6.1.1 Urządzenie



Rengör generatorn invändigt med tryckluft med lågt tryck och pensel med mjuk borst. Kontrollera de elektriska anslutningarna och alla kabelkopplingar.

6.1.2 Underhåll eller utbyte av komponenter i brännarna, elektrodhållaren och/eller jordledningen:



Kontrollera komponenternas temperatur och att de inte är överhettade.



Använd alltid handskar som uppfyller kraven i regler och bestämmelser.



Använd lämpliga nycklar och verktyg.

6.2 Odpowiedzialność



Om detta underhåll inte utförs upphör alla garantier att gälla och tillverkaren kan inte utkrävas något ansvar för konsekvenserna. Tillverkaren påtar sig inget ansvar om operatören inte följer dessa anvisningar. Kontakta närmaste serviceverkstad vid tveksamheter och/eller problem.

7. LARMKODER



LARM













Om ett larm utlöses eller en kritisk övervakningsgräns överskrids visas en ljussignalering på kontrollpanelen och svetsningen blockeras omedelbart.





OBS

Om ett larm utlöses eller en kritisk övervakningsgräns överskrids visas en ljussignalering på kontrollpanelen och svetsningen blockeras omedelbart.

Nedan listas samtliga larm och övervakningsgränser för systemet.

 E01	Överhettning		 E02	Överhettning	
 E03	Överhettning		 E05	Överström	
 E06	Överström hos effektmodul (Boost)		 E07	Fel på systemet för strömförsörjning av trådmatningens motor	

 E08	Moteur bloqué		 E10	Överström hos effektmodul (Inverter)	
 E11	Fel systemkonfiguration		 E12	Kommunikationsfel (WF - DSP)	
 E13	Kommunikationsfel		 E14	Ogiltigt program	
 E15	Ogiltigt program		 E16	Kommunikationsfel (RI) (Automation och robotteknik)	
 E17	Kommunikationsfel (µP-DSP)		 E18	Ogiltigt program	
 E19	Fel systemkonfiguration		 E20	Defekt minne	
 E21	Förlust av data		 E22	Kommunikationsfel (DSP)	
 E29	Inkompatibla mätvärden		 E30	Kommunikationsfel (H.F.)	
 E32	Förlust av data		 E38	Underspänning	
 E39	Fel strömförsörjning av aggregatet		 E40	Fel strömförsörjning av aggregatet	
 E43	Saknas kylvätska		 E48	Saknas tråd (Automation och robotteknik)	
 E49	Nödbrytare (Automation och robotteknik)		 E50	Fastklistrad tråd (Automation och robotteknik)	
 E51	Inställningarna understöds inte (Automation och robotteknik)		 E52	Kollisionsskydd (Automation och robotteknik)	
 E53	Fel på extern flödesvakt (Automation och robotteknik)		 E54	Överskriden strömnivå (Nedre gräns)	
 E55	Överskriden strömnivå (Övre gräns)		 E56	Överskriden spänningsnivå (Nedre gräns)	
 E57	Överskriden spänningsnivå (Övre gräns)		 E60	Överskriden hastighetsgräns (Nedre gräns)	
 E61	Överskriden hastighetsgräns (Övre gräns)		 E62	Överskriden strömnivå (Nedre gräns)	

 E63	Överskriden strömnivå (Övre gräns)	A↑	 E64	Överskriden spänningsnivå (Nedre gräns)	V↓
 E65	Överskriden spänningsnivå (Övre gräns)	V↑	 E68	Överskriden hastighetsgräns (Nedre gräns)	
 E69	Överskriden hastighetsgräns (Övre gräns)		 E70	Inställda larmgränser är inte kompatibla	
 E71	Överhettad kylvätska		 E72	Överström hos push-pull-motor	
 E73	Överskriden trådastighetsgräns (speed meter)		 E74	Överskriden strömnivå för motor 1	Aφ
 E75	Överskriden strömnivå för motor 2	Aφ	 E76	Överskriden flödesnivå för kylvätska	
 E77	Temperaturnivå för kylvätska		 E78	Aktivt underhåll (Automation och robotteknik)	

8. FELSÖKNING OCH TIPS

Aggregatet startar inte (den gröna kontrolllampan är släckt)

Orsak

- » Ingen nätspänning i strömförsörjningsuttaget.
- » Fel på stickpropp eller elsladd.
- » Linjesäkring har gått.
- » Fel på huvudströmbrytaren.
- » Anslutningen mellan trådmatningsvagnen och generatoren felaktig.
- » Elektroniskt fel.

Lösning

- » Kontrollera och reparera elsystemet.
- » Vänd dig till specialutbildad personal.
- » Byt ut den skadade komponenten.
- » Kontakta närmaste serviceverkstad för reparation av aggregatet.
- » Byt ut den skadade komponenten.
- » Byt ut den skadade komponenten.
- » Kontakta närmaste serviceverkstad för reparation av aggregatet.
- » Kontrollera att systemets olika delar är rätt anslutna.
- » Kontakta närmaste serviceverkstad för reparation av aggregatet.

Ingen uteffekt (aggregatet svetsar inte)

Orsak

- » Fel på brännarknappen.
- » Aggregatet är överhettat (överhettningsskydd - den gula kontrolllampan lyser).
- » Sidopanel öppen eller fel på dörrströmbrytaren.
- » Felaktig jordning.
- » Matspänningen ligger utanför tillåtet intervall (den gula kontrolllampan lyser).
- » Elektroniskt fel.

Lösning

- » Byt ut den skadade komponenten.
- » Kontakta närmaste serviceverkstad för reparation av aggregatet.
- » Vänta tills aggregatet svalnar utan att stänga av det.
- » Av säkerhetsskäl måste sidopanelen vara stängd under svetsningen.
- » Byt ut den skadade komponenten.
- » Kontakta närmaste serviceverkstad för reparation av aggregatet.
- » Jorda aggregatet ordentligt.
- » Se avsnittet "Igångsättning".
- » Se till att nätspänningen håller sig inom intervallet för matning av aggregatet.
- » Anslut aggregatet enligt anvisningarna.
- » Se avsnittet "Anslutning".
- » Kontakta närmaste serviceverkstad för reparation av aggregatet.

Felaktig uteffekt

Orsak

- » Felaktig inställning av svetsningen eller fel på väljaren.
- » Felaktig inställning av parametrar och funktioner för aggregatet.
- » Fel på potentiometer/dataomvandlare för inställning av svetsström.
- » Matarspänningen ligger utanför tillåtet intervall.
- » En fas saknas.
- » Elektroniskt fel.

Lösning

- » Gör om inställningarna för svetsningen.
- » Byt ut den skadade komponenten.
- » Kontakta närmaste serviceverkstad för reparation av aggregatet.
- » Återställ aggregatet och ställ in parametrarna för svetsningen igen.
- » Byt ut den skadade komponenten.
- » Kontakta närmaste serviceverkstad för reparation av aggregatet.
- » Anslut aggregatet enligt anvisningarna.
- » Se avsnittet "Anslutning".
- » Anslut aggregatet enligt anvisningarna.
- » Se avsnittet "Anslutning".
- » Kontakta närmaste serviceverkstad för reparation av aggregatet.

Trådmatningen blockerad

Orsak

- » Fel på brännarknappen.
- » Felinställda eller utslitna valsar.
- » Fel på kuggväxelmotorn.
- » Brännarmanteln skadad.
- » Ingen ström till trådmatningen.
- » Oregelbunden upplindning på rullen.
- » Brännarmunstycket har smält (tråden sitter fast).

Lösning

- » Byt ut den skadade komponenten.
- » Kontakta närmaste serviceverkstad för reparation av aggregatet.
- » Byt ut valsarna.
- » Byt ut den skadade komponenten.
- » Kontakta närmaste serviceverkstad för reparation av aggregatet.
- » Byt ut den skadade komponenten.
- » Kontakta närmaste serviceverkstad för reparation av aggregatet.
- » Kontrollera anslutningen till aggregatet.
- » Se avsnittet "Anslutning".
- » Kontakta närmaste serviceverkstad för reparation av aggregatet.
- » Återställ normala upplindningsförhållanden eller byt ut rullen.
- » Byt ut den skadade komponenten.

Oregelbunden trådmatning

Orsak

- » Fel på brännarknappen.
- » Felinställda eller utslitna valsar.
- » Fel på kuggväxelmotorn.
- » Brännarmanteln skadad.
- » Trådrullens friktion eller låsanordningarna för rullarna felinställda.

Lösning

- » Byt ut den skadade komponenten.
- » Kontakta närmaste serviceverkstad för reparation av aggregatet.
- » Byt ut valsarna.
- » Byt ut den skadade komponenten.
- » Kontakta närmaste serviceverkstad för reparation av aggregatet.
- » Byt ut den skadade komponenten.
- » Kontakta närmaste serviceverkstad för reparation av aggregatet.
- » Minska friktionen.
- » Öka trycket på rullarna.

Instabil båge

Orsak

- » Otillräcklig skyddsgas.
- » Fukt i svetsgasen.
- » Felaktiga parametrar för svetsningen.

Lösning

- » Justera gasflödet.
- » Kontrollera att brännarens diffusor och munstycke är i gott skick.
- » Använd alltid produkter och material med hög kvalitet.
- » Se till att systemet för gasförsörjning hålls i perfekt skick.
- » Kontrollera svetsaggregatet noggrant.
- » Kontakta närmaste serviceverkstad för reparation av aggregatet.

Mycket stänk

Orsak

- » Felaktig båglängd.

Lösning

- » Minska avståndet mellan elektroden och arbetsstycket.
- » Minska arbetsspänningen.

» Felaktiga parametrar för svetsningen.	» Minska arbetsspänningen.
» Otillräcklig skyddsgas.	» Justera gasflödet.
	» Kontrollera att brännarens diffusor och munstycke är i gott skick.
» Felaktig bågdynamik.	» Öka induktansen i kretsen.
	» Använd ett större induktansuttag.
» Felaktigt utförd svetsning.	» Minska brännarens lutning.

Otillräcklig inträngning

Orsak	Lösning
» Felaktigt utförd svetsning.	» Sänk frammatningshastigheten för svetsning.
» Felaktiga parametrar för svetsningen.	» Öka svetsströmmen.
» Felaktig elektrod.	» Använd en elektrod med mindre diameter.
» Felaktig förberedelse av kanterna.	» Öka diktjärnets öppning.
» Felaktig jordning.	» Jorda aggregatet ordentligt.
	» Se avsnittet "Igångsättning".
» Stora arbetsstycken som ska svetsas.	» Öka svetsströmmen.

Slagginneslutningar

Orsak	Lösning
» Otillräcklig slaggborttagning.	» Rengör arbetsstyckena ordentligt innan svetsningen.
» För stor elektroddiameter.	» Använd en elektrod med mindre diameter.
» Felaktig förberedelse av kanterna.	» Öka diktjärnets öppning.
» Felaktigt utförd svetsning.	» Minska avståndet mellan elektroden och arbetsstycket.
	» Arbeta jämnt under alla svetsningsfaserna.

Volframminneslutningar

Orsak	Lösning
» Felaktiga parametrar för svetsningen.	» Minska arbetsspänningen.
	» Använd en elektrod med större diameter.
» Felaktig elektrod.	» Använd alltid produkter och material med hög kvalitet.
	» Slipa elektroden enligt anvisningarna.
» Felaktigt utförd svetsning.	» Undvik kontakt mellan elektroden och smältbadet.

Blåsor

Orsak	Lösning
» Otillräcklig skyddsgas.	» Justera gasflödet.
	» Kontrollera att brännarens diffusor och munstycke är i gott skick.

Ingen sammansmältning

Orsak	Lösning
» Felaktig båglängd.	» Öka avståndet mellan elektroden och arbetsstycket.
	» Öka arbetsspänningen.
» Felaktiga parametrar för svetsningen.	» Öka svetsströmmen.
	» Öka arbetsspänningen.
» Felaktigt utförd svetsning.	» Öka brännarens lutning.
» Stora arbetsstycken som ska svetsas.	» Öka svetsströmmen.
» Felaktig bågdynamik.	» Öka induktansen i kretsen.
	» Använd ett större induktansuttag.

Sidoskåror

Orsak	Lösning
» Felaktiga parametrar för svetsningen.	» Minska arbetsspänningen.
	» Använd en elektrod med mindre diameter.

» Felaktig båglängd.

» Minska avståndet mellan elektroden och arbetsstycket.

» Minska arbetsspänningen.

» Felaktigt utförd svetsning.

» Sänk oscillationshastigheten i sidled under fyllningen.

» Sänk frammatningshastigheten för svetsning.

» Otillräcklig skyddsgas.

» Använd gas som lämpar sig för det material som ska svetsas.

Oxidering

Orsak

» Otillräcklig skyddsgas.

Lösning

» Justera gasflödet.

» Kontrollera att brännarens diffusor och munstycke är i gott skick.

Porositet

Orsak

» Fett, färg, rost eller smuts på de arbetsstycken som ska svetsas.

Lösning

» Rengör arbetsstyckena ordentligt innan svetsningen.

» Fett, färg, rost eller smuts på svetsmaterialet.

» Använd alltid produkter och material med hög kvalitet.

» Håll alltid svetsmaterialet i perfekt skick.

» Fukt i svetsmaterialet.

» Använd alltid produkter och material med hög kvalitet.

» Håll alltid svetsmaterialet i perfekt skick.

» Felaktig båglängd.

» Minska avståndet mellan elektroden och arbetsstycket.

» Minska arbetsspänningen.

» Fukt i svetsgasen.

» Använd alltid produkter och material med hög kvalitet.

» Se till att systemet för gasförsörjning hålls i perfekt skick.

» Otillräcklig skyddsgas.

» Justera gasflödet.

» Kontrollera att brännarens diffusor och munstycke är i gott skick.

» Smältbadet stelnar för snabbt.

» Sänk frammatningshastigheten för svetsning.

» Värm upp de arbetsstycken som ska svetsas i förväg.

» Öka svetsströmmen.

Varmsprickor

Orsak

» Felaktiga parametrar för svetsningen.

Lösning

» Minska arbetsspänningen.

» Använd en elektrod med mindre diameter.

» Fett, färg, rost eller smuts på de arbetsstycken som ska svetsas.

» Rengör arbetsstyckena ordentligt innan svetsningen.

» Fett, färg, rost eller smuts på svetsmaterialet.

» Använd alltid produkter och material med hög kvalitet.

» Håll alltid svetsmaterialet i perfekt skick.

» Felaktigt utförd svetsning.

» Utför rätt driftsmoment för den fog som ska svetsas.

» Arbetsstycken med olika egenskaper.

» Buttra innan svetsningen.

Kallsprickor

Orsak

» Fukt i svetsmaterialet.

Lösning

» Använd alltid produkter och material med hög kvalitet.

» Håll alltid svetsmaterialet i perfekt skick.

» Speciell form på den fog som ska svetsas.

» Värm upp de arbetsstycken som ska svetsas i förväg.

» Värm upp arbetsstyckena efteråt.

» Utför rätt driftsmoment för den fog som ska svetsas.

9. TEORETISKA PRINCIPER FÖR SVETSNING

9.1 Svetsning med belagd elektrod (MMA)

Förberedelse av kanterna

För bästa resultat bör man alltid arbeta med rena delar, utan oxidering, rost eller andra förorenande ämnen.

Val av elektrod

Vilken diameter elektroden ska ha beror på materialets tjocklek, typ av fog och typ av diktjärn. Elektroder med stor diameter fordrar hög strömstyrka vilket medför hög värmeutveckling under svetsningen.

Typ av beläggning	Egenskaper	Användning
Rutil	Lätthanterlighet	Alla positioner
Sur	Hög sammansmältningshastighet	Plan
Basisk	Mekaniska egenskaper	Alla positioner

Val av svetsström

Svetsströmsintervallen för den använda elektrodtypen framgår av elektrodförpackningen.

Att tända och bibehålla bågen

Den elektriska bågen skapas genom att man gnider elektrodspetsen mot det arbetsstycke som ska svetsas, vilket ska vara anslutet till jordledningen. När bågen har uppstått drar man snabbt tillbaka elektroden till normalt svetsningsavstånd.

För att förbättra tändningen är det i allmänhet lämpligt att öka strömstyrkan inledningsvis jämfört med den vanliga svetsströmmen (Hot Start). När den elektriska bågen har bildats börjar elektrodens mittersta del smälta och lägger sig som droppar på arbetsstycket. När elektrodens yttre beläggning förbrukas bildas skyddande gas som ger svetsningen hög kvalitet. För att undvika att dropparna av smält material kortsluter elektroden med smältbadet om dessa av misstag kommer i kontakt med varandra och därmed släcker bågen kan man med fördel använda en tillfällig ökning av svetsströmmen till dess att kortslutningen har upphört (Arc Force). Om elektroden fastnar i arbetsstycket bör man minska kortslutningsströmmen så mycket som möjligt (anti-sticking).

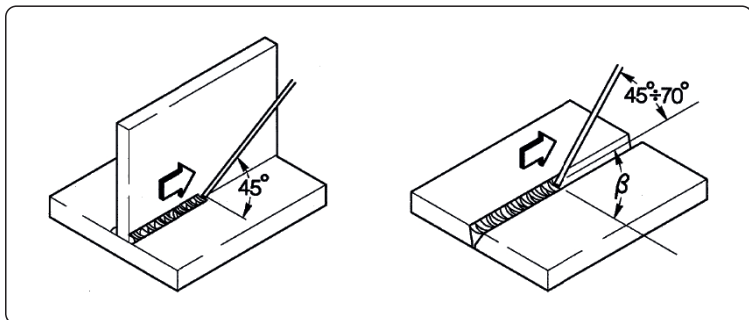

Svetsning

Elektrodens lutningsvinkel beror på antalet svetssträngar. Elektroden förs vanligen i en svängande rörelse med stopp vid ändarna av svetsstället för att undvika att för mycket svetsmaterial ansamlas i mitten.

Slaggborttagning

Vid svetsning med belagda elektroder tas slaggen bort efter varje svetssträng. Borttagningen utförs med en liten hammare eller genom att borsta av lös slag.

9.2 TIG-Svetsning (kontinuerlig båge)

Beskrivning

Principen bakom TIG-svetsning (Tungsten Inert Gas) är att en elektrisk båge bildas mellan en icke avsmältande elektrod (av ren volfram eller volframlegering med en smälttemperatur på cirka 3370 °C) och arbetsstycket. En skyddsgas (argon) skyddar smältbadet. För att undvika farliga volframminneslutningar i fogen får elektroden aldrig komma i kontakt med arbetsstycket. Därför genereras en urladdning som tändar den elektriska bågen på avstånd med hjälp av en HF-generator. Det finns också en annan tändningsmetod som ger mindre volframminneslutningar: s.k. lift-tändning. I stället för hög frekvens startar man med kortslutning med svag strömstyrka mellan elektroden och arbetsstycket. När elektroden sedan lyfts upp bildas bågen och strömstyrkan ökar upp till inställt värde. För att den sista delen av svetssträngen ska få god kvalitet är det bra att kunna kontrollera minskningen av svetsströmmen med precision och det fordras att gasen flödar i smältbadet under några sekunder efter det att bågen har släckts. I många driftssammanhang är det bra att ha 2 förinställda svetsströmmar och lätt kunna gå från den ena till den andra (BILEVEL).

Svetsningspolaritet

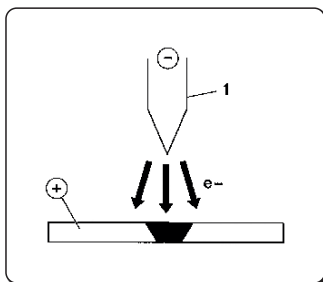

D.C.S.P. (Direct Current Straight Polarity)

Detta är den vanligaste metoden (normal polaritet). Den orsakar ett begränsat slitage på elektroden (1) eftersom 70 % av värmen koncentreras på anoden (arbetsstycket). Smältbadet blir smalt och djupt med hög frammatningshastighet och därmed låg värmeutveckling.

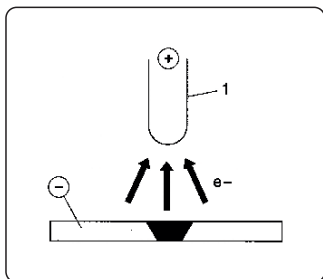

D.C.R.P. (Direct Current Reverse Polarity)

Med omvänd polaritet kan man svetsa legeringar täckta med ett eldfast oxidskikt med högre smältemperatur än metallen. Man kan inte använda hög strömstyrka eftersom detta skulle leda till högt slitage på elektroden.

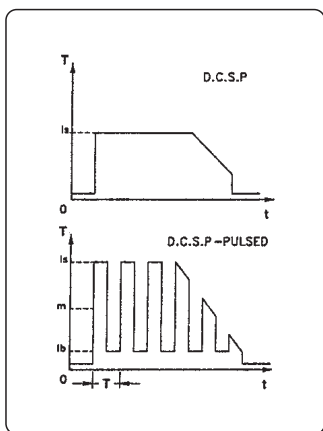

D.C.S.P.-Pulsed (Direct Current Straight Polarity Pulsed)

Genom att använda pulsad likström får man bättre kontroll av smältbadet under vissa driftsförhållanden. Smältbadet bildas av toppströmmarna (I_p), medan basströmmen (I_b) håller igång bågen. På så sätt underlättas svetsning i material med liten tjocklek och resultatet blir färre deformationer, bättre formfaktor och följaktligen mindre risk för sprickor och gasinneslutningar. Vid ökad frekvens (medelfrekvens) blir bågen smalare, mer koncentrerad och stabil och kvaliteten vid svetsning i tunna material förbättras ytterligare.

TIG-svetsning av stål

TIG-metoden är mycket effektiv vid svetsning av både kolstål och legeringar, för den första svetssträngen på rör och för svetsningar där utmärkta estetiska egenskaper fordras. Direkt polaritet (D.C.S.P.) används.

Förberedelse av kanterna

Denna metod fordrar en noggrann rengöring och förberedelse av kanterna.

Val och förberedelse av elektrod

Vi rekommenderar att toriumöverdragna volframelektroder (2 % torium - röd), alternativt elektroder belagda med cerium eller lantan, med följande diametrar används:

Ø elektrod	Strömstyrkeintervall
1.0 mm	15÷75 A
1.6 mm	60÷150 A
2.4 mm	130÷240 A

Elektroden formas som i figuren.

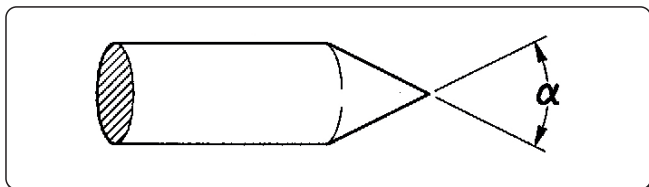

α°	Strömstyrkeintervall
30	0÷30 A
60÷90	30÷120 A
90÷120	120÷250 A

SV

Svetsmaterial

Svetsstavarna ska ha liknande mekaniska egenskaper som basmaterialet.

Vi rekommenderar inte användning av remsor tagna från basmaterialet, eftersom de kan innehålla orenheter orsakade av bearbetningen som kan inverka negativt på svetsningen.

Skyddsgas

Ren argon (99,99 %) används praktiskt taget alltid.

Svetsström	Ø elektrod	Gasmunstycke n°	Gasmunstycke	Argonflöde
30 A	0÷30 mm	4/5	6/8.0 mm	5-6 l/min
60÷90 A	30÷120 mm	4/5/6	6.5/8.0/9.5 mm	6-7 l/min
90÷120 A	120÷250 mm	6/7	9.5/11.0 mm	7-8 l/min

TIG-svetsning av koppar

Eftersom TIG-svetsning är en metod med hög värmekoncentration är den särskilt lämplig vid svetsning av material med hög värmeledningsförmåga, som t. ex. koppar.

Följ anvisningarna för TIG-svetsning av stål ovan eller särskilda instruktioner för TIG-svetsning av koppar.

9.3 Svetsning med kontinuerlig tråd (MIG/MAG)

Inledning

Ett MIG-system består av en likströmgenerator, en matningsanordning och en trådrulle, en brännare samt gas.

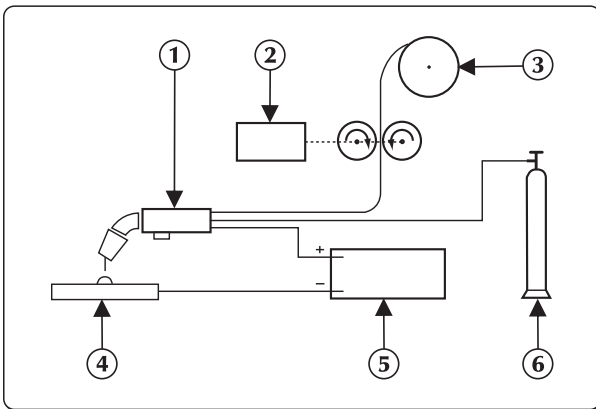

Manuellt svetsaggregat

Strömmen passerar den avsmältande elektroden (tråd med positiv polaritet);

Vid denna process överförs den smälta metallen på arbetsstycket genom bågen.

Tråden måste matas fram för att ersätta den elektrod som smälter under svetsningen.

Tillvägagångssätt

Vid svetsning med skyddsgas kan dropparna överföras från elektroden på två olika sätt.

Den första metoden kallas "ÖVERFÖRING MED KORTSLUTNING (SHORT-ARC)". Här kommer elektroden i direkt kontakt med smältbadet, varefter en kortslutning sker. Tråden fungerar som en säkring och smälter. Därefter tänds bågen igen och cykeln upprepas.

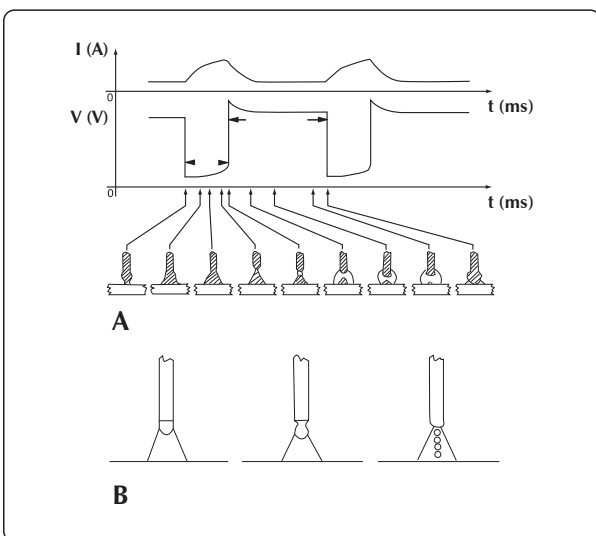

Cykel vid SHORT ARC respektive SPRAY ARC

Ett annat sätt att överföra dropparna är så kallad "ÖVERFÖRING MED STRÅLE (SPRAY-ARC)", där dropparna först lösgör sig från elektroden och sedan hamnar i smältbadet.

Svetsparametrar



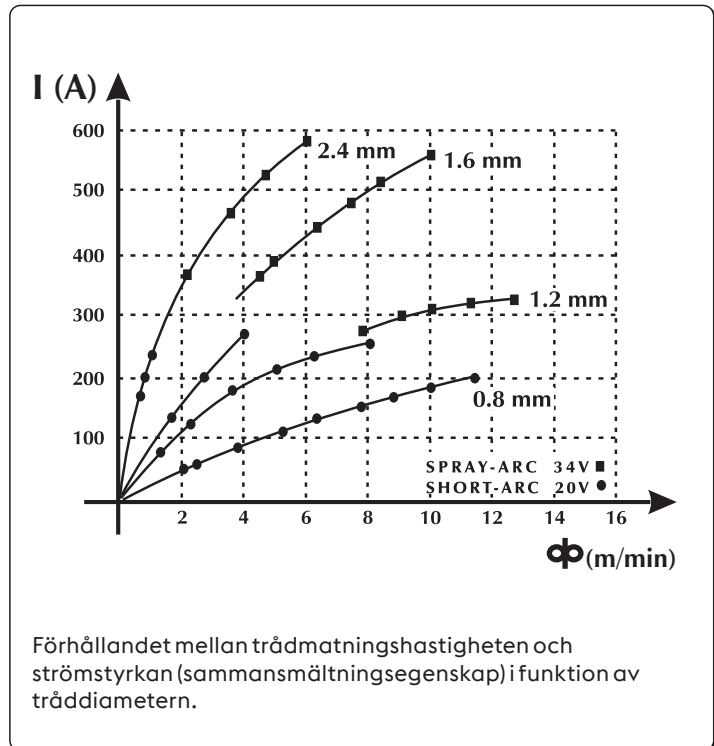
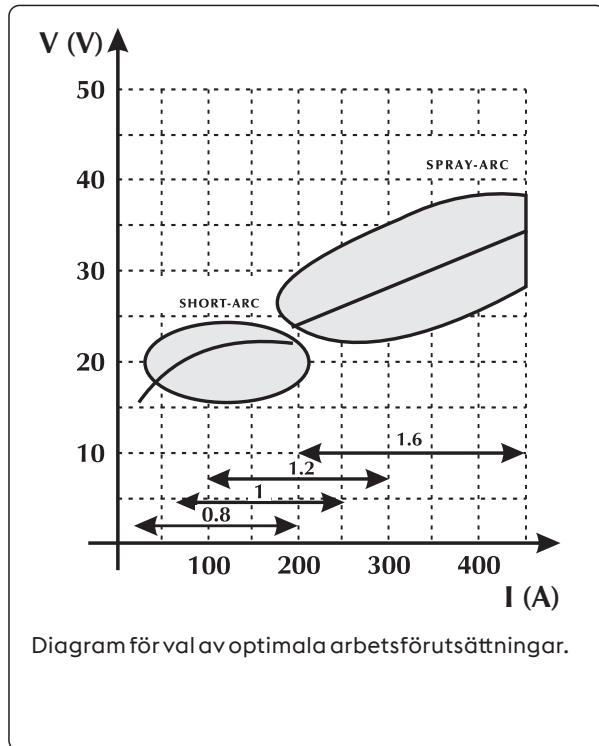

Eftersom bågen är synlig minskar behovet att strikt hålla sig till inställningstabellerna: du har direkt kontroll över smältbadet.

- Spänningen inverkar direkt på svetssträngens utseende, men den svetsade ytans storlek kan du variera efter behov genom att manuellt flytta brännaren så att beläggningen blir olika med konstant spänning.
- Trådmätningshastigheten står i relation till svetsströmmen.

Poniższe dwa wykresy przedstawiają zależności między poszczególnymi parametrami spawania.

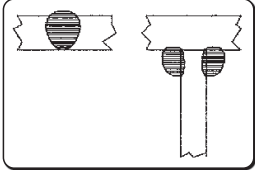
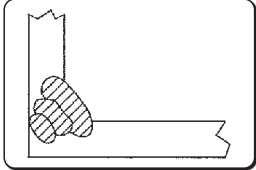
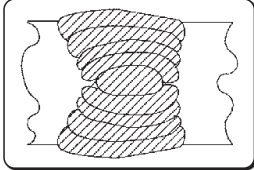

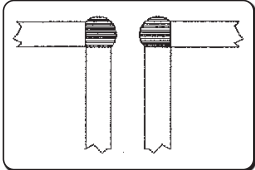
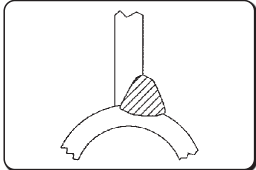
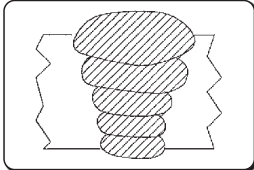
Vägledande tabell för val av svetsningsparametrar för de mest typiska användningsområdena och de vanligaste trådarna

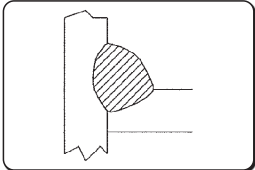
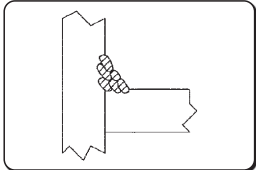
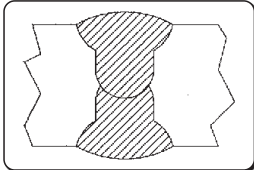
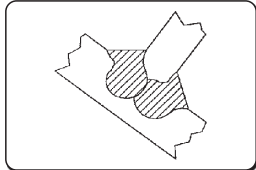
Bågspänning	Ø 0,8 mm	Ø 1,0-1,2 mm	Ø 1,6 mm	Ø 2,4 mm
16V - 22V SHORT - ARC				
	60 - 160 A Låg inträngning för små tjocklekar	100 - 175 A God kontroll över inträngning och sammansmältning	120 - 180 A God sammansmältning horisontellt och vertikalt	150 - 200 A Används ej
24V - 28V PUOLI LYHYTKAARI (SEMI SHORT-ARC) (Övergångszon)				
	150 - 250 A Automatisk kälsvetsning	200 - 300 A Automatisk svetsning med hög spänning	250 - 350 A Automatisk svetsning nedåt	300 - 400 A Används ej
30V - 45V SPRAY - ARC				
	150 - 250 A Låg inträngning med inställning på 200 A	200 - 350 A Automatisk svetsning med flera svetssträngar	300 - 500 A God inträngning nedåt	500 - 750 A God inträngning och hög deposition på stora tjocklekar

Gaser som kan användas

MIG-/MAG-svetsning kännetecknas huvudsakligen av den slags gas som används: inert vid MIG-svetsning (Metal Inert Gas), aktiv vid MAG-svetsning (Metal Active Gas).

- Koldioxid (CO₂)

Med CO₂ som skyddsgas erhåller man en hög inträngning med hög matningshastighet och goda mekaniska egenskaper till en låg driftskostnad. Nackdelen är att denna gas skapar betydande problem med fogarnas slutgiltiga kemiska sammansättning, eftersom element som lätt oxideras går förlorade, samtidigt som kolhalten i smältbadet ökar. Svetsning med ren CO₂ medför även andra problem, såsom mycket stänk och bildande av koloxidporer.

- Argon

Denna inerta gas används ren vid svetsning av lätta legeringar. För svetsning i rostfritt stål med kromnickel är det bättre att arbeta med tillsats av 2% syre och CO₂, vilket bidrar till att göra bågen stabil och svetssträngen bättre formad.

- Helium

Denna gas används som ett alternativ till argon. Den ger bättre inträngning (vid stora tjocklekar) och högre matningshastighet.

- Argon/heliumblandning

Ger en stabilare båge än ren helium samt bättre inträngning och hastighet än argon.

- Blandningar av Argon/CO₂ och Argon/CO₂/syre

Dessa blandningar används vid svetsning av järnhaltigt material, framför allt med SHORT-ARC som ökar värmeförseln. Detta utesluter inte användning med SPRAY-ARC.

Normalt innehåller blandningen en CO₂-andel på mellan 8% och 20% och O₂ på cirka 5%.

Se systemets instruktionsbok.

10. TEKNISKA DATA

Elektriska egenskaper			U.M.
Nätspänning U1 (50/60 Hz)	3x230 (±15%)	3x400 (±15%)	Vac
Z _{max} (@PCC) *	62	62	mΩ
Trög linjesäkring	30	20	A
Kommunikationsbuss	DIGITAL	DIGITAL	
Maximal upptagen spänning	13.3	13.0	kVA
Maximal upptagen spänning	12.8	12.4	kW
Effektförbrukning vid avaktiverat tillstånd	71	71	W
Effektfaktor (PF)	0.96	0.95	
Effektivitet (μ)	85	85	%
Cos φ	0.99	0.99	
Maximal strömförbrukning I _{1max}	32.9	18.8	A
Strömmens effektivvärde I _{1eff}	20.8	13.3	A
Inställningsintervall (MMA)	3-320	3-320	A
Tomgångsström U ₀	75	75	Vdc

* Den här utrustningen uppfyller de krav som ställs i EN / IEC 61000-3-11.

* Denna utrustning uppfyller kraven enligt EN / IEC 61000-3-12 om maximalt tillåten nätimpedans vid den gemensamma anslutningspunkten (PCC) till det allmänna elnätet är mindre än eller lika med angivet värde på "Z_{max}". Om den ansluts till ett allmänt lågspänningssystem är det den som installerar eller använder utrustningen som ansvarar för att kontrollera att utrustningen får anslutas (genom att rådfråga elnätsleverantören vid behov).

Utnyttjningsfaktor	3x230V	3x400V	U.M.
Utnyttjningsfaktor MMA (40°C)			
(X=35%)	320	-	A
(X=50%)	-	320	A
(X=60%)	270	300	A
(X=100%)	230	250	A
Utnyttjningsfaktor MMA (25°C)			
(X=60%)	320	320	A
(X=100%)	270	270	A
Utnyttjningsfaktor TIG (40°C)			
(X=45%)	320	-	A
(X=60%)	300	320	A
(X=100%)	250	270	A
Utnyttjningsfaktor TIG (25°C)			
(X=70%)	320	320	A
(X=100%)	270	270	A
Utnyttjningsfaktor MIG/MAG (40°C)			
(X=35%)	320	-	A
(X=50%)	-	320	A
(X=60%)	280	310	A
(X=100%)	230	250	A
Utnyttjningsfaktor MIG/MAG (25°C)			
(X=60%)	320	-	A
(X=70%)	-	320	A
(X=100%)	270	270	A

Fysiska egenskaper			U.M.
IP-skyddsgrad	IP23S		
Isoleringsklass	H		
Mått (lxbxh)	620x240x460		mm
Vikt	26.7		Kg
Konstruktionsbestämmelser	EN IEC 60974-1/A1:2019 EN IEC 60974-3:2019 EN 60974-10/A1:2015		
Strömkabelsektion	4x4		mm ²
Nätkabelns längd	5		m

11. MÄRKPLÅT

VOESTALPINE BÖHLER WELDING SELCO S.R.L. Via Palladio, 19 - ONARA (PADOVA) - ITALY				
URANOS NX 3200 PME		N°		
EN 60974-1/A1:2019 IEC 60974-10/A1:2015 Class A				
	---	3A/20.0V - 320A (320A)/32.8V (32.8V)		
		X (40°C)	50% (35%)	60%
	U ₀	I ₂	320A (320A)	300A (270A) 250A (230A)
	75V	U ₂	32.8V (32.8V)	32.0V (30.8V) 30.0V (29.2V)
	---	3A/10.0V - 320A (320A)/22.8V (22.8V)		
		X (40°C)	(45%)	60%
	U ₀	I ₂	(320A)	320A (300A) 270A (250A)
	75V	U ₂	(22.8V)	22.8V (22.0V) 20.8V (20.0V)
	---	3A/14.0V - 320A (320A)/30.0V (30.0V)		
		X (40°C)	50% (35%)	60%
	U ₀	I ₂	320A (320A)	310A (280A) 250A (230A)
	75V	U ₂	30.0V (30.0V)	29.5V (28.5V) 26.5V (25.5V)
U ₁ 400V(230V)		I _{1max} 18.8A(32.9A)		I _{1eff} 13.3A(20.8A)
IP 23 S				

12. MÄRKPLÅTENS INNEBÖRD

1		2			
3		4			
5		6			
7	9	23			
		11			
8	10	12	15	16	17
		13	15A	16A	17A
		14	15B	16B	17B
		12	15	16	17
8	10	13	15A	16A	17A
		14	15B	16B	17B
		12	15	16	17
		13	15A	16A	17A
14	15B	16B	17B		
18	19	20	21		
22					

CE EU-försäkran om överensstämmelse
 EAC EAC-försäkran om överensstämmelse
 UKCA UKCA-försäkran om överensstämmelse

- 1 Fabrikat
- 2 Tillverkarens namn och adress
- 3 Apparatens modell
- 4 Serienummer
XXXXXXXXXXXXX Tillverkningsår
- 5 Symbol för svetstyp
- 6 Hänvisning till tillverkningsstandarder
- 7 Symbol för svetsprocess
- 8 Symbol för svetsar som lämpar sig för arbete i utrymmen med förhöjd risk för elstötar
- 9 Symbol för svetsström
- 10 Nominell tomgångsspänning
- 11 Intervall för max. och min. nominell svetsström och motsvarande normal belastningsspänning
- 12 Symbol för intermittenscykel
- 13 Symbol för nominell svetsström
- 14 Symbol för nominell svetsspänning
- 15 Värdet för intermittenscykel
- 16 Värdet för intermittenscykel
- 17 Värdet för intermittenscykel
- 15A Värdet för nominell svetsström
- 16A Värdet för nominell svetsström
- 17A Värdet för nominell svetsström
- 15B Värdet för normal belastningsspänning
- 16B Värdet för normal belastningsspänning
- 17B Värdet för normal belastningsspänning
- 18 Symbol för nätanslutning
- 19 Nominell matningsspänning
- 20 Max. nominell matningsström
- 21 Max. effektiv matningsström
- 22 Kapslingsklass
- 23 Nominell toppspänning

SV

INDHOLDSFORTEGNELSE

1. ADVARSEL	375
1.1 Brugsomgivelser	375
1.2 Personlig beskyttelse og beskyttelse af andre	375
1.3 Beskyttelse mod røg og gas	376
1.4 Forebyggelse af brand/eksplosion	376
1.5 Forholdsregler ved brug af gasflasker	377
1.6 Beskyttelse mod elektrisk stød	377
1.7 Elektromagnetiske felter og forstyrrelser	377
1.8 IP-beskyttelsesgrad	378
1.9 Bortskaffelse.....	378
2. INSTALLERING	379
2.1 Løfte-, transport- og aflæsningsanvisninger.....	379
2.2 Placering af anlægget.....	379
2.3 Tilslutning	379
2.4 Idriftsættelse.....	380
3. PRÆSENTATION AF ANLÆGGET	382
3.1 Bagpanel	382
3.2 Stikkontaktpanel.....	382
3.3 Frontbetjeningspanel	382
3.4 Frontbetjeningspanel	383
4. UDSTYR BRUG	384
4.1 Startskærm	384
4.2 Testskærm billede	384
4.3 Hovedskærmen.....	384
4.4 Hovedbilledskærm MMA proces	385
5. SETUP.....	392
5.1 Set-up og indstilling af parametrene.....	392
5.2 Specifikke procedurer for brug af parametrene	401
6. VEDLIGEHOLDELSE	406
6.1 Regelmæssig kontrol af strømkilden.....	406
6.2 ОТВЕТСТВЕННОСТЬ	406
7. ALARMKODER	406
8. FEJLFINDING OG LØSNINGER	408
9. GODE RÅD OM SVEJSNING I	412
9.1 Svejsning med beklædt elektrode (MMA)	412
9.2 TIG-svejsning (kontinuerlig lysbue).....	412
9.3 Svejsning med kontinuerlig tråd (MIG/MAG).....	414
10. TEKNISKE SPECIFIKATIONER.....	417
11. DATASKILT	418
12. BETYDNING AF OPLYSNINGERNE DATASKILT	418
13. OVERSIGT	557
14. KONNEKTORER.....	559
15. RESERVEDELSLISTE.....	560

SYMBOLER



Overhængende fare, der kan medføre alvorlige legemsbeskadigelser, samt farlige handlemåder, der kan forårsage alvorlige læsioner.



Handlemåder, der kan medføre mindre alvorlige legemsbeskadigelser eller beskadigelse af ting.



Bemærkninger med dette symbol foran er af teknisk karakter og gør indgrebene lettere at udføre.

1. ADVARSEL



Inden der udføres nogen form for indgreb, skal man have læst og forstået denne vejledning.

Der må ikke udføres ændringer på maskinen eller vedligeholdelse, der ikke er beskrevet i vejledningen. Fabrikanten påtager sig intet ansvar for legemsbeskadigelser eller beskadigelse af ting, opstået på grund af manglende læsning eller udførelse af indholdet i denne vejledning.

Opbevar altid brugsanvisningerne på apparatets brugssted. Overhold ikke blot brugsanvisningerne, men også de generelle forskrifter og de gældende lokale regler for forebyggelse af ulykker og miljøhensyn.



Всички лица, занимаващи се с въвеждането в експлоатация, самата експлоатация, поддръжката и поправката на уреда, трябва:

- да притежават специална квалификация
- да разполагат с необходимите компетенции в сферата на заваряването
- да прочетат изцяло и да спазват стриктно настоящите инструкции за употреба

Tag kontakt til en fagmand i tilfælde af tvivl eller problemer omkring anlæggets brug, også selvom problemet ikke omtales heri.

1.1 Brugsomgivelser



Ethvert anlæg må udelukkende benyttes til dets forudsete brug, på de måder og områder, der er anført på dataskiltet og/eller i denne vejledning, og i henhold til de nationale og internationale sikkerhedsforskrifter. Anden brug end den, fabrikanten udtrykkeligt har angivet, skal betragtes som uhensigtsmæssig og farlig og vil fritage fabrikanten for enhver form for ansvar for skade.



Dette apparat må udelukkende anvendes til professionelle formål i industrielle omgivelser. Fabrikanten fralægger sig ethvert ansvar for skader forårsaget af anlæggets brug i private omgivelser.



Anlægget skal anvendes i omgivelser med en temperatur på mellem -10°C og +40°C (mellem +14°F og +104°F).

Anlægget skal transporteres og opbevares i omgivelser med en temperatur på mellem -25°C og +55°C (mellem -13°F og 131°F).

Anlægget skal benyttes i omgivelser uden støv, syre, gas eller andre ætsende stoffer.

Anlægget skal benyttes i omgivelser med en relativ luftfugtighed på højst 50 % a 40°C (104°F).

Anlægget skal benyttes i omgivelser med en relativ luftfugtighed på højst 90 % ved 20°C (68°F).

Anlægget må ikke benyttes i en højde over havet på over 2000m (6500 fod).



Anvend ikke apparatet til optøning af rør.

Benyt aldrig dette apparatur til opladning af batterier og/eller akkumulatorer.

Benyt aldrig dette apparatur til start af motorer.

1.2 Personlig beskyttelse og beskyttelse af andre



Svejsprocessen er kilde til skadelig stråling, støj, varme og gasudsendelse. Anbring en brandsikker afskærmning for at beskytte omgivelserne svejsmiljø mod stråler, gnister og glødende affald. Advar andre tilstedeværende om, at de ikke må rette blikket direkte mod svejsningen, og at de skal beskytte sig imod buens stråler eller glødende metalstykker.



Bær beskyttelsestøj til beskyttelse af huden mod lysbuestrålerne, gnister eller glødende metal. Den benyttede beklædning skal dække hele kroppen og være:

- intakt og i god stand
- brandsikker
- isolerende og tør
- tætsiddende og uden opslag



Benyt altid godkendt og slidstærkt sikkerhedsfodtøj, der er i stand til at sikre isolering mod vand.

Benyt altid godkendte sikkerhedshandsker, der yder en elektrisk og termisk isolering.



Anvend masker med sideskærme for ansigtet og egnet beskyttelsesfilter (mindst NR10 eller højere) for øjnene.



Benyt altid beskyttelsesbriller med sideafskærmning, især ved manuel eller mekanisk fjernelse af svejse-affaldet.



Bær aldrig kontaktlinser!

DA



Benyt høreværn, hvis svejseprocessen når op på farlige støjniveauer. Hvis støjniveauet overskrider de grænser, der er fastlagt i lovgivningen, skal man afgrænse arbejdsområdet og sørge for, at de personer der har adgang, er beskyttet med høreværn.



Hold altid sidepanelerne lukkede under svejsearbejdet. Der må aldrig udføres nogen form for ændringer på anlægget.



Hold altid sidepanelerne lukkede under svejsearbejdet. Undgå at hænder, hår, beklædning, værktøj... kommer i berøring med bevægelige dele så som: ventilatorer, tandhjul, valser og aksler, trådspoler. Rør aldrig ved tandhjulene, mens trådfremføringsenheden er i funktion. Der må aldrig udføres nogen form for ændringer på anlægget. Omgåelse af beskyttelsesanordningerne på trådfremføringsenheden er ekstremt farlig og fritager fabrikanten for ethvert ansvar for skader på personer eller genstande.



Hold hovedet på lang afstand af MIG/MAG-brænderen under trådens isætning og fremføring. Tråden i udgang kan forårsage alvorlige skader på hænder, ansigt og øjne.



Undgå berøring af emner, der lige er blevet svejset. Varmen vil kunne forårsage alvorlige skoldninger eller forbrændinger.

Overhold alle ovenfor beskrevne forholdsregler, også under bearbejdnings efter svejsningen, da svejseaffald kan falde af de bearbejdede emner, der er ved at køle af.



Kontrollér, at brænderen er kølet af, inden der udføres bearbejdnings eller vedligeholdelse.



Kontrollér, at kølegruppen er slukket, inden kølevæskens tilførsels- og afledningslanger kobles fra. Den varme væske, der løber ud af rørene, vil kunne forårsage alvorlige skoldninger eller forbrændinger.



Sørg for, at der er førstehjælpsudstyr til rådighed. Undervurder aldrig forbrændinger og sår.



Genopret sikre forhold i området, inden arbejdsområdet forlades, således at utilsigtet skade på personer og genstande undgås.

1.3 Beskyttelse mod røg og gas



Røg, gas og støv fra svejse-arbejdet kan medføre sundhedsfare. Røgen, der produceres under svejseprocessen, kan under visse forhold forårsage cancer eller fosterskade.

- Hold hovedet på lang afstand af svejsningens gas og røg.
- Sørg for ordentlig naturlig eller mekanisk udluftning i arbejdsområdet.
- Benyt svejsemasker med udsugning, hvis lokalets ventilation er utilstrækkelig.
- Ved svejsning i snævre omgivelser anbefales det, at der er en kollega til stede udenfor området til overvågning af den medarbejder, der udfører selve svejsningen.
- Anvend aldrig ilt til udluftning.
- Undersøg udsugningens effektivitet ved, med jævne mellemrum, at sammenholde emissionsmængden af giftig gas med de tilladte værdier i sikkerhedsforskrifterne.
- Mængden og farligheden af den producerede røg kan tilbageføres til det anvendte basismateriale, til det tilførte materiale samt til eventuelt anvendte rengøringsmidler eller affedtningsmidler på det emne, der skal svejdes. Følg omhyggeligt fabrikantens anvisninger og de relevante tekniske datablade.
- Udfør aldrig svejsning i nærheden af områder, hvor der foretages affedtning eller maling.
- Placer gasflaskerne udendørs eller på steder med korrekt luftcirkulation.

1.4 Forebyggelse af brand/eksplosion



Svejse-processen kan være årsag til brand og/eller eksplosion.

- Fjern antændelige eller brændbare materialer eller genstande fra arbejdsområdet og det omkringliggende område.
- Brændbare materialer skal befinde sig mindst 11 meter fra svejseområdet og skal beskyttes på passende vis.
- Gnister og glødende partikler kan nemt blive spredt vidt omkring og nå de omkringliggende områder, også gennem små åbninger. Udvis særlig opmærksomhed omkring sikring af personer og genstande.
- Udfør aldrig svejsning oven over eller i nærheden af beholdere under tryk.
- Udfør aldrig svejsning på lukkede beholdere eller rør. Udfør aldrig svejsning eller skæring på lukkede beholdere eller rør. Udvis særlig opmærksomhed under svejsning af rør eller beholdere, også selv om de er åbne, tomme og omhyggeligt rengjorte.

Rester af gas, brændstof, olie og lignende kan forårsage eksplosioner.

- Udfør aldrig svejse-arbejde i en atmosfære med eksplosionsfarlige pulvermaterialer, gasser eller dampe.
- Kontrollér efter afsluttet svejsning, at kredsløbet under spænding ikke utilsigtet kan komme i berøring med elementer, der er forbundet til jordforbindelseskredsløbet.
- Sørg for, at der er brandslukningsudstyr til rådighed i nærheden af arbejdsområdet.

1.5 Forholdsregler ved brug af gasflasker



Gasflasker med inaktiv gas indeholder gas under tryk og kan eksplodere hvis transport-, opbevarings- og brugsforholdene ikke sikres efter forskrifterne.

- Gasflaskerne skal fastspændes opretstående på en væg eller lignende med egnede midler, så de ikke kan vælte eller støde sammen.
- Skru beskyttelseshætten på ventilen under transport, klargøring, og hver gang svejsearbejdet er fuldført.
- Undgå at gasflaskerne udsættes for direkte solstråler, pludselige temperaturudsving, for høje eller for lave temperaturer. Udsæt aldrig gasflaskerne for meget lave eller høje temperaturer.
- Undgå omhyggeligt, at gasflaskerne kommer i berøring med åben ild, elektriske buer, brændere, elektrodeholdertænger eller med glødende partikler fra svejsningen.
- Hold gasflaskerne på lang afstand af svejsekredsløb og strømkredsløb i almindelighed.
- Hold hovedet på lang afstand af det punkt, hvorfra gassen strømmer ud, når der åbnes for gasflaskens ventil.
- Luk altid for gasflaskens ventil, når svejsningen er fuldført.
- Udfør aldrig svejsning på en gasflaske under tryk.
- Tilslut aldrig en tryklufthflaske direkte til maskinens trykregulator! Trykket kan overskride trykregulatorens kapacitet, således at der opstår fare for eksplosion!

1.6 Beskyttelse mod elektrisk stød



Et elektrisk stød kan være dødbringende.

- Undgå berøring af strømførende dele både inden i og uden på svejseægget, så længe anlægget er under forsyning (brændere, tænger, jordforbindelseskabler, elektroder, ledninger, valser og spoler er elektrisk forbundet til svejsekredsløbet).
- Sørg for, at anlæg og elektrisk isoleret ved hjælp af tørre plader og sokler med tilstrækkelig isolering mod mulig jordforbindelse.
- Kontrollér, at anlægget er forbundet korrekt til et stik og en strømkilde udstyret med en jordledning.
- Berør aldrig to svejsebrændere eller to elektrodeholdertænger samtidigt.
- Afbryd øjeblikkeligt svejse-arbejdet, hvis det føles, som om der modtages elektrisk stød.

1.7 Elektromagnetiske felter og forstyrrelser



Passagen af strøm igennem anlæggets indvendige og udvendige kabler skaber et elektromagnetisk felt i umiddelbar nærhed af svejsekablerne og af selve anlægget.

- Elektromagnetiske felter kan forårsage (på nuværende tidspunkt ukendte) helbredseffekter ved længerevarende påvirkning.
- De elektromagnetiske felter kan påvirke andet apparatur så som pacemakere eller høreapparater.



Bærere af vitale elektroniske apparater (pacemaker) bør konsultere en læge, inden de kommer i nærheden af lysbuesvejsninger.

1.7.1 Klassificering EMC i overensstemmelse med: EN 60974-10/A1:2015.

Klasse
B

Udstyr i klasse B overholder kravene vedrørende elektromagnetisk kompatibilitet i industrielle miljøer og private boliger, herunder boligområder, hvor elektriciteten leveres via det offentlige lavspændingsforsyningsnet.

Klasse
A

Udstyr i klasse A er ikke beregnet til brug i boligområder, hvor elektriciteten leveres via det offentlige lavspændingsforsyningsnet. Der kan være visse vanskeligheder med at sikre elektromagnetisk kompatibilitet for klasse A-udstyr i sådanne områder på grund af ledningsbårne forstyrrelser og strålingsforstyrrelser.

For mere information, se kapitlet: DATASKILT eller TEKNISKE SPECIFIKATIONER.

1.7.2 Installering, brug og vurdering af området

Dette apparat er bygget i overensstemmelse med kravene i den harmoniserede standard EN 60974-10/A1:2015 og er identificeret som et "KLASSE A"-apparat. Dette apparat må udelukkende anvendes til professionelle formål i industrielle omgivelser. Fabrikanten fralægger sig ethvert ansvar for skader forårsaget af anlæggets brug i private omgivelser.



Brugeren skal have ekspertise indenfor arbejdsområdet, og han/hun er i denne henseende ansvarlig for installering og brug af apparatet i overensstemmelse med fabrikantens anvisninger. Hvis der opstår elektromagnetiske forstyrrelser, er det brugerens opgave at løse problemet med hjælp fra fabrikantens tekniske servicetjeneste.



Elektromagnetiske forstyrrelser skal under alle omstændigheder reduceres i en sådan grad, at de ikke længere har nogen indflydelse.



Inden dette apparat installeres, skal brugeren vurdere de eventuelle elektromagnetiske problemer, der kan opstå i det omkringliggende område, specielt hvad angår de tilstedeværende personers sundhedstilstand, fx: brugere af pacemakere og høreapparater.

1.7.3 Krav til strømtilførsel (Se tekniske specifikationer)

Højspændingsudstyr kan på grund af primærstrømmen, som hentes fra forsyningsnettet, påvirke nettets strømkvalitet. For visse typer af udstyr (se tekniske specifikationer) kan der være restriktioner eller krav vedrørende strømtilslutningen med hensyn til strømforsyningsens højeste tilladte impedans (Z_{max}) eller den påkrævede minimumskapacitet (S_{sc}) ved tilslutningsstedet til det offentlige elnet (point of common coupling, PCC). Hvis det er tilfældet, er det montørens eller brugerens ansvar at sikre, at udstyret kan tilsluttes; eventuelt ved henvendelse til elseskabet. Ved interferens kan der opstå behov for yderligere forholdsregler, så som filtrering af netforsyningen.

Desuden skal man overveje muligheden for afskærmning af forsyningskablet.

For mere information, se kapitlet: TEKNISKE SPECIFIKATIONER.

1.7.4 Forholdsregler vedrørende ledningerne

Følg nedenstående regler for at reducere virkningen af de elektromagnetiske felter:

- Rul, om muligt, jordforbindelses- og effektkablerne op og fastspænd dem.
- Undgå at vikle svejsekablet rundt om kroppen.
- Undgå at stå imellem jordforbindeskablet og effektkablet (hold begge kabler på samme side).
- Kablerne skal holdes så korte som muligt, og de skal placeres så tæt sammen som muligt og føres nær eller på gulvplanet.
- Placer anlægget i en vis afstand af svejseområdet.
- Kablerne skal holdes adskilt fra alle øvrige kabler.

1.7.5 Potentialudligning

Der skal tages højde for stelforbindelse af alle metalkomponenter på svejse-anlægget og i den umiddelbare nærhed. Overhold den nationale lovgivning vedrørende potentialudligning.

1.7.6 Jordforbindelse af arbejdsemnet

Hvis arbejdsemnet ikke er jordforbundet af hensyn til den elektriske sikkerhed eller p.g.a. dets størrelse og placering, kan en stelforbindelse mellem emnet og jorden reducere udsendelserne. Vær opmærksom på, at jordforbindelsen af arbejdsemnet ikke må øge risikoen for arbejdsulykker for brugerne eller beskadige andre elektriske apparater. Overhold den nationale lovgivning vedrørende jordforbindelse.

1.7.7 Afskærmning

Afskærmning af udvalgte kabler og apparater i det omkringliggende område kan løse interferensproblemer.

Muligheden for afskærmning af hele svejse-anlægget kan overvejes i specielle arbejdssituationer.

1.8 IP-beskyttelsesgrad



IP23S

- Indkapslingen er beskyttet mod indføring af fingre og faste fremmedlegemer med en diameter større end/lig med 12,5 mm og berøring af farlige dele.
- Indkapslingen er beskyttet mod regn i en vinkel på op til 60° fra lodret position.
- Indkapslingen er beskyttet mod skader forårsaget af vandindtrængning, når apparaturets bevægelige dele ikke er i bevægelse.

1.9 Bortskaffelse



Apparatet må ikke bortskaffes med normalt affald.

I overensstemmelse med det europæiske direktiv 2012/19/EU om affald af elektrisk og elektronisk udstyr og dets implementering i overensstemmelse med national lovgivning skal elektrisk udstyr, der er udtjent, indsamles separat og sendes til nyttiggørelse og bortskaffelse. Ejeren af udstyret skal identificere de autoriserede indsamlingscentre ved at forhøre sig hos kommunen. Anvendelsen af det europæiske direktiv vil forbedre miljøet og menneskers sundhed.

2. INSTALLERING



Installeringen må kun udføres af erfarent personale, der godkendt af svejsemaskinens fabrikant.



Ved installering skal man sørge for, at strømkilden er afbrudt fra forsyningsnettet.



Der er forbudt at forbinde strømkilderne (i serie eller parallelt).

2.1 Løfte-, transport- og aflæsningsanvisninger

- Anlægget er udstyret med et greb, der giver mulighed for at transportere det i hånden.
- Anlægget er ikke udstyret med specielle løfteelementer.
- Benyt en gaffellift og udvis stor forsigtighed under flytninger, for at undgå at generatoren vælter.



Undervurder aldrig anlæggets vægt, (læs de tekniske specifikationer).

Lad aldrig læsset glide hen over - eller hænge stille over - mennesker eller ting.

Lad aldrig anlægget eller de enkelte enheder falde eller støtte mod jordoverfladen med stor kraft.

2.2 Placering af anlægget



Overhold nedenstående forholdsregler:

- Der skal være nem adgang til betjeningsorganerne og tilslutningspunkterne.
- Placér aldrig udstyret i snævre områder.
- Anbring aldrig anlægget på en overflade med en hældning på over 10° i forhold til det vandrette plan.
- Slut anlægget til i et tørt, rent område med god udluftning.
- Beskyt anlægget mod direkte regn og solstråler.

2.3 Tilslutning



Anlægget er udstyret med et forsyningskabel til tilslutning til ledningsnettet.

Anlægget kan forsynes med:

- 400V trefase
- 230V trefase

Apparatets funktion er garanteret ved spændinger, der afviger op til $\pm 15\%$ fra den nominelle værdi, (for eksempel: Ved V_{nom} 400V er arbejds-spændingen mellem 320V og 440V).



For at undgå personskader eller beskadigelse af anlægget skal man kontrollere den valgte netspænding og sikringerne, **INDEN** maskinen tilsluttes nettet. Desuden skal man sikre, at kablet tilsluttes en stikkontakt, der er udstyret med jordkontakt.



Det er muligt at forsyne anlægget via et generator-aggregat, hvis dette blot sikrer en stabil forsynings-spænding på $\pm 15\%$ af værdien af den mærkespænding, som fabrikanten har oplyst, under alle mulige driftsforhold og ved den maksimale mærkeeffekt, som strømkilden kan levere. Det anbefales, som en norm, at benytte generator-aggregater med en effekt svarende til det dobbelte af strømkildens effekt, hvis den er enfaset, og svarende til 1,5 gang så stor, hvis den er trefaset. Det anbefales at benytte elektronisk styrede generator-aggregater.



Af hensyn til brugernes sikkerhed skal anlægget være korrekt jordforbundet. Forsyningskablet er udstyret med en (gul-grøn) leder til jordforbindelse, der skal tilsluttes en stikkontakt med jordkontakt. Denne gul/grønne ledning må **ALDRIG** benyttes sammen med andre ledninger til spændingsudtag. Kontrollér, at der findes en "jordforbindelse" på det anvendte anlæg, samt at stikkontakten er i korrekt stand. Montér udelukkende typegodkendte stik i overensstemmelse med sikkerhedsreglerne.



De elektriske forbindelser skal være udført af teknikere, der opfylder de specifikke faglige og tekniske krav, samt være i overensstemmelse med den nationale lovgivning i det land, hvor installeringen finder sted.

2.4 Idriftsættelse

2.4.1 Tilslutning til MMA-svejsning



Tilslutningen vist på tegningen giver svejsning med omvendt polaritet. Hvis man ønsker svejsning med direkte polaritet, skal tilslutningen byttes om.

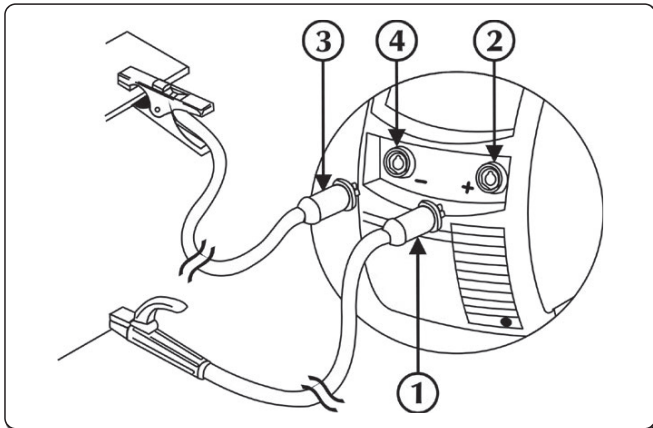

- ① Stik til jordforbindelsestang
- ② Negativt effektudtag (-)
- ③ Stik til elektrodeholdertang
- ④ Positivt effektudtag (+)

- ▶ Tilslut jordklemmen til den negative pol (-) på strømforsyningen. Sæt stikket i og drej med uret, indtil elementerne er skruet fuldstændigt fast.
- ▶ Tilslut elektrodeholderen til den positive pol (+) på strømforsyningen. Sæt stikket i og drej med uret, indtil elementerne er skruet fuldstændigt fast.

2.4.2 Tilslutning til TIG-svejsning

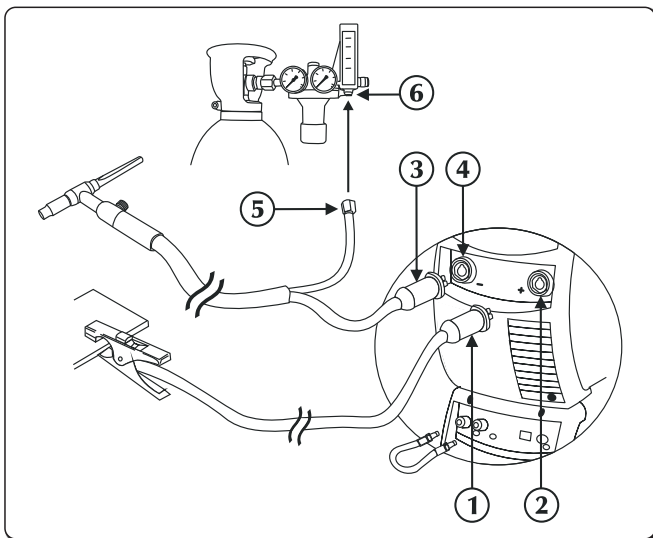



- ① Stik til jordforbindelsestang
- ② Positivt effektudtag (+)
- ③ Fastgørelse af TIG-fakkel
- ④ Brændertilslutning
- ⑤ Gasrørsstik
- ⑥ Trykreduktoren

- ▶ Tilslut jordklemmen til den positive pol (+) på strømforsyningen. Sæt stikket i og drej med uret, indtil elementerne er skruet fuldstændigt fast.
- ▶ Tilslut TIG-svejsbrænderstikket til svejsestikket på strømforsyningen. Sæt stikket i og drej med uret, indtil elementerne er skruet fuldstændigt fast.





Beskyttelsesgassen reguleres ved hjælp af den hane, der normalt findes på brænderen.

- ▶ Tilslut forbindelsesstykket på brænderens gasslange separat til selve gasforsyningen.
- ▶ Forbind brænderens kølevæsketilbageløbsslange (rød farve) med det relevante samlestykke/kobling (rød farve - symbol ).
- ▶ Forbind brænderens kølevæsketilførselsslange (blå farve) med det relevante samlestykke/kobling (blå farve - symbol .

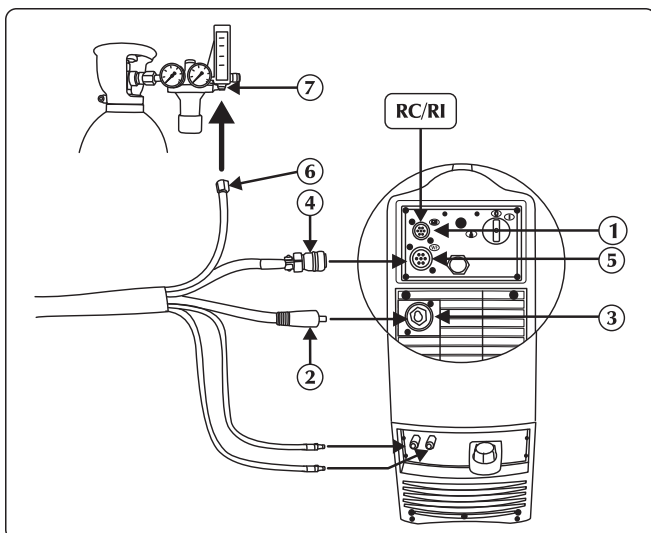
2.4.3 Tilslutning til MIG/MAG-svejsning



- ① Signalkabel (CAN-BUS) input
- ② Effektkabel
- ③ Positivt effektudtag (+)
- ④ Signalkabel
- ⑤ Indgang signalkabel (CAN-BUS) (kabelbundet)
- ⑥ Gasrør
- ⑦ Samlestykke til gastilførsel

- ▶ Forbind kabelbundtets effektkabel til det relevante udtag. Sæt stikket i og drej med uret, indtil elementerne er skruet fuldstændigt fast.
- ▶ Forbind kabelbundtets signalkabel til den relevante konnektor. Sæt forbindelsesleddet i og drej ringmøtrikken med uret, indtil delene sidder helt fast.
- ▶ Forbind kabelbundtets gasslange til gasflaskens trykregulering eller til samlestykket på gasforsyningen. Indstil gasstrømningen på mellem 10 og 30 l/min.
- ▶ Forbind kabelbundtets kølevæsketilførselsslange (blå farve) med det relevante samlestykke/kobling (blå farve - symbol ).
- ▶ Forbind kabelbundtets kølevæsketilbageførselsslange (rød farve) med det relevante samlestykke/kobling (rød farve - symbol ).

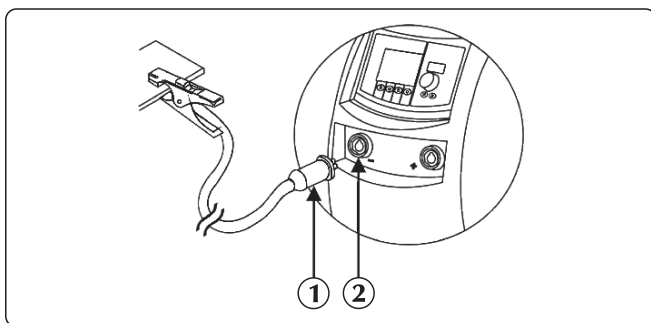

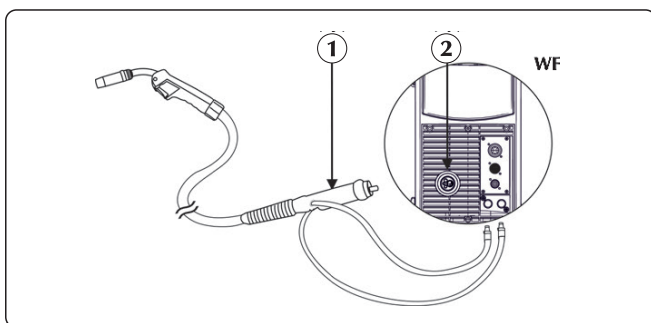

- ① Stik til jordforbindelsestang
- ② Negativt effektudtag (-)

- ▶ Tilslut jordklemmen til den negative pol (-) på strømforsyningen. Sæt stikket i og drej med uret, indtil elementerne er skruet fuldstændigt fast.



- ① Brændertilslutning
- ② Konnektor

- ▶ Forbind brænderens kølevæsketilførselsslange (blå farve) med det relevante samlestykke/kobling (blå farve - symbol ).
- ▶ Forbind brænderens kølevæsketilbageførselsslange (rød farve) med det relevante samlestykke/kobling (rød farve - symbol ).
- ▶ Forbind MIG/MAG-brænderen til adapteren. Vær specielt påpasselig med at stramme fastgøringsringen fuldstændigt.

3. PRÆSENTATION AF ANLÆGGET

3.1 Bagpanel

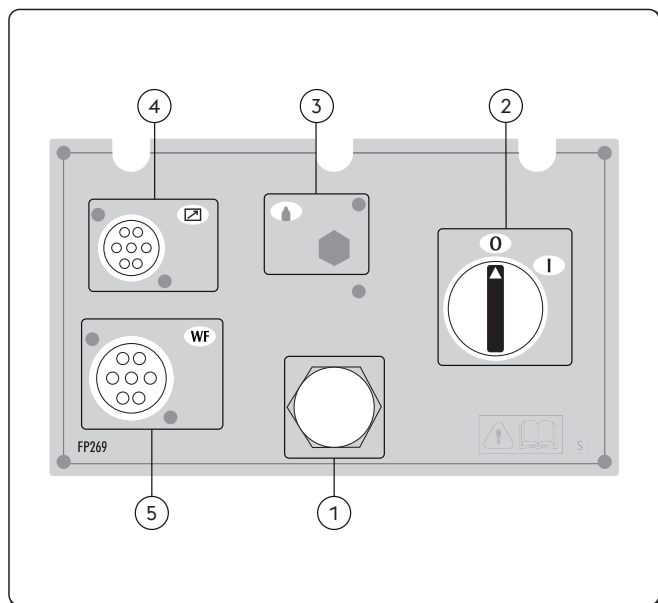

- ① **Forsyningskabel**
Kablet giver mulighed for at forsyne anlægget og koble det til ledningsnettet.
- ② **Tændingskontakt**
Styrer den elektriske tænding af svejsemaskinen. Den kan stilles i to positioner: "0" slukket; "I" tændt.
- ③ **Anvendes ikkeo**
- ④ **Signalkabel CAN-BUS input (RC, RI...)**
- ⑤ **Indgang signalkabel (CAN-BUS) (kabelbundet)**

3.2 Stikkontaktpanel

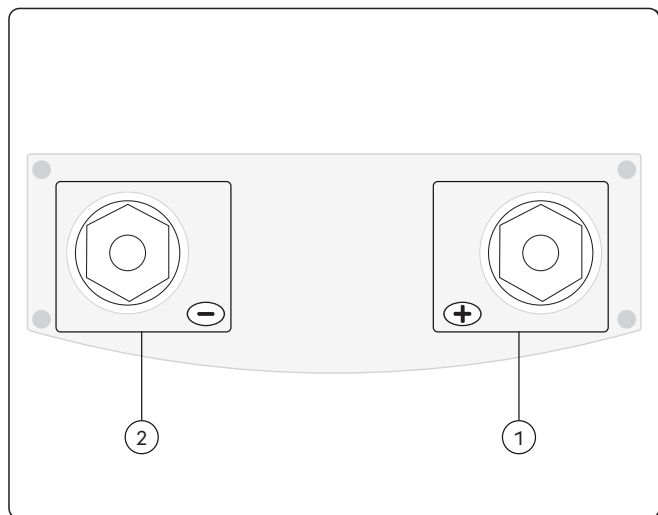

- ① **Positivt effektudtag (+)**
Proces MMA: Tilslutning elektrodebrænder
Proces TIG: Tilslutning jordkabel
- ② **Negativt effektudtag (-)**
Proces MMA: Tilslutning jordkabel
Proces TIG: Tilslutning brænder
MIG/MAG proces: Tilslutning jordkabel

DA



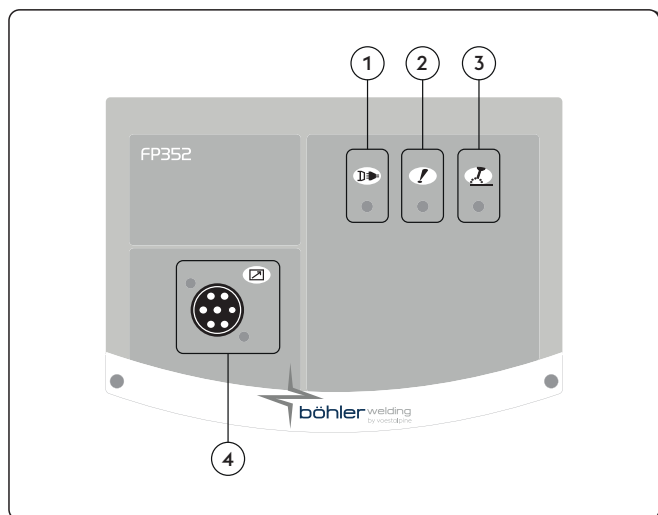



3.3 Frontbetjeningspanel

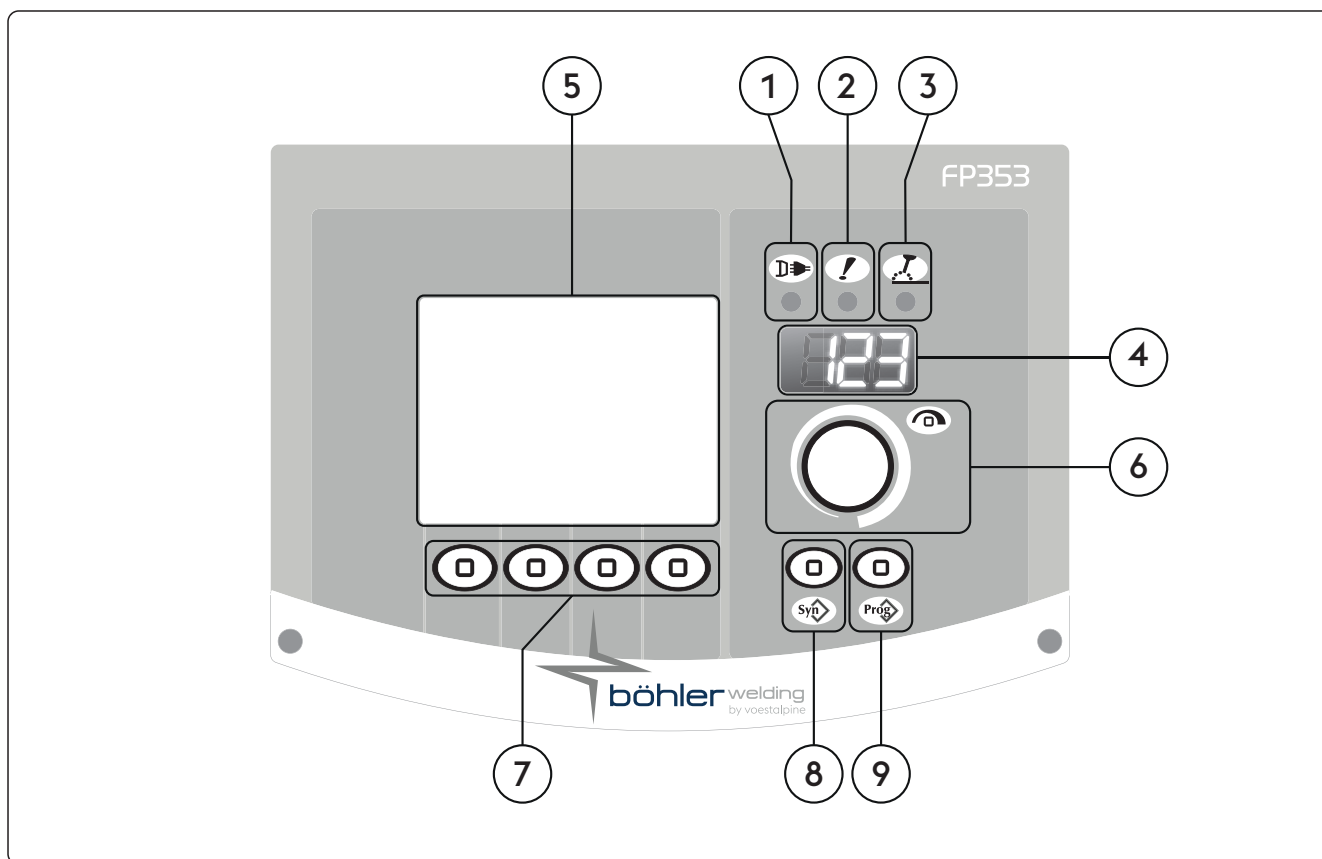

- ① **LED for strømforstyring**
Angiver, at anlægget er tilsluttet forsyningsnettet og tændt.
- ② **LED for generel alarm**
Angiver, at beskyttelsesordninger, som f.eks. temperaturbeskyttelsen, kan aktiveres.
- ③ **LED for aktiv effekt**
Angiver, at der er spænding på anlæggets udgangsforbindelser.
- ④ **Signalkabel CAN-BUS input (RC, RI...)**

3.4 Frontbetjeningspanel



- 1  **LED for strømforsyning**
Angiver, at anlægget er tilsluttet forsyningsnettet og tændt.
- 2  **LED for generel alarm**
Angiver, at beskyttelsesanordninger, som f.eks. temperaturbeskyttelsen, kan aktiveres.
- 3  **LED for aktiv effekt**
Angiver, at der er spænding på anlæggets udgangsforbindelser.
- 4  **7-segment display**
Gør det muligt at vise svejsemaskinens generelle parametre under opstart, indstillinger, strøm- og spændingsaflysninger, under svejsning og indkodning af alarmer.
- 5  **LCD-display**
Gør det muligt at vise svejsemaskinens generelle parametre under opstart, indstillinger, strøm- og spændingsaflysninger, under svejsning og indkodning af alarmer.
Alle aktiviteter kan vises samtidig.
- 6  **Reguleringshåndtag**
Giver mulighed for indtastning af valg og indstilling af svejseparametrene.
- 7  **Funktionsknapper**
Gør det muligt at vælge systemets forskellige funktioner:
- Svejsproces
- Svejsemetoder
- Strømpulsering
- Grafik-funktion

8 Programknap

Gør det muligt at vælge et forud indstillet program ved at vælge nogle enkelte oplysninger:

- Type tråd
- Gastype
- Tråddiameter

9 Tasten job

Giver mulighed for at lagre og styre 240 svejseprogrammer, som kan operatøren selv kan skræddersy.

4. UDSKYR BRUG

4.1 Startskærm

Når generatoren tændes, udfører den en række check for at sikre at såvel systemet som det tilsluttede udstyr fungerer, som de skal. Samtidig udføres gastesten for at checke, om forbindelsen til gastilførselssystemet er i orden.

4.2 Testskærbillede

Når sidepanelet (spolerum) er åbent, hindres svejseoperationerne.

På displayet LCD fremkommer testskærbilledet.

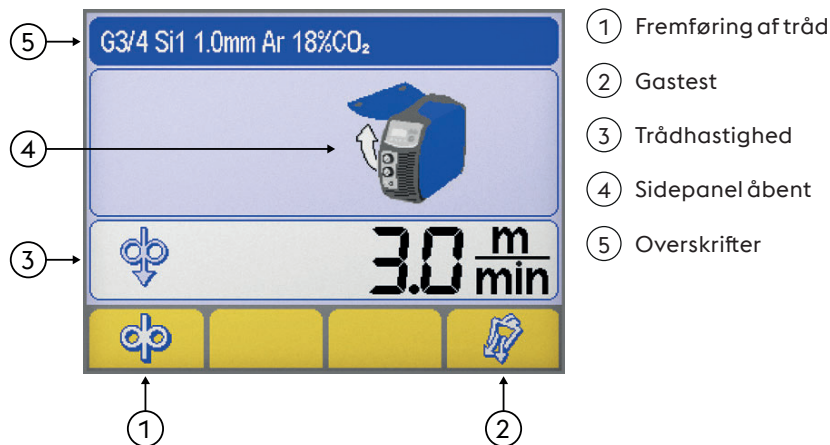

Fremføring af tråd

Giver mulighed for manuel trådfremføring uden gasstrømning og uden strøm på tråden.

Giver mulighed for indsættelse af tråden i brænderens kappe under forberedelserne til svejsningen.



Gastest

Gør det muligt at rense gaskredsløbet for urenheder og, uden output-power, at foretage de indledende gstryk- og flowreguleringer.



Trådhastighed

Gør det muligt at regulere trådfremføringshastigheden (under påsætningstrinnet).

Minimum	Maksimum	Default
0.5 m/min	22.0 m/min	3.0 m/min



Sidepanel åbent



Overskrifter

Gør det muligt at se de vigtigste informationer om de valgte processer.

4.3 Hovedskærmen

Giver mulighed for at styre systemet og svejseprocessen, da den viser de væsentligste indstillinger.

4.4 Hovedbilledskærm MMA proces

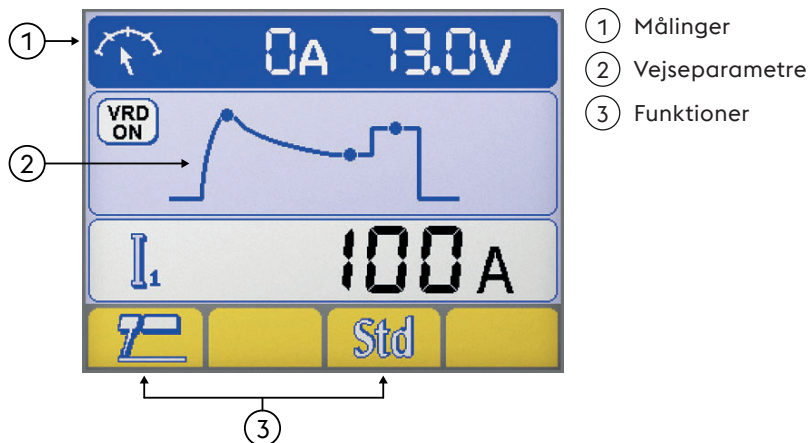

Målinger

I svejsefaserne vises de reelle strøm- og spændingsmål på LCD displayet.

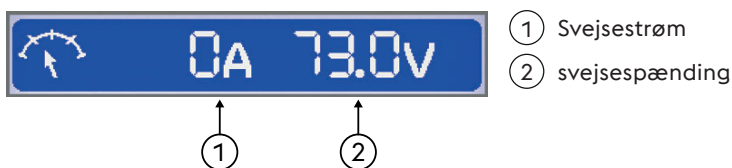

Vejseparametre

► Vælg de ønskede parametre ved at trykke på encoderknappen.

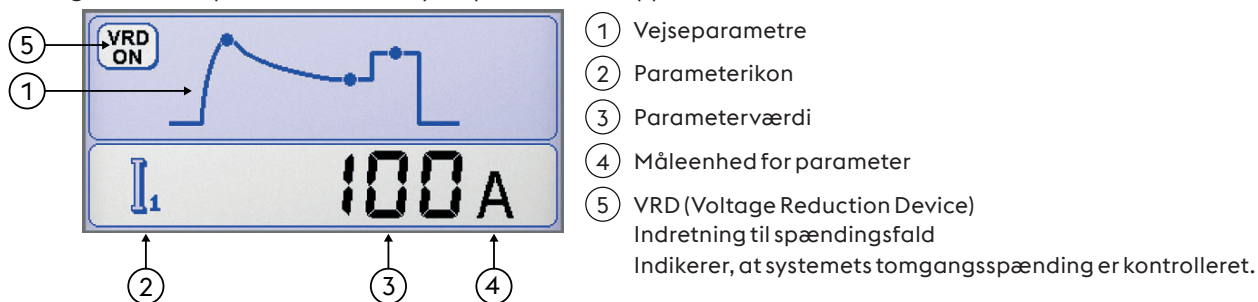

Funktioner

Gør det muligt at indstille de vigtigste procesfunktioner og svejsemetoder.

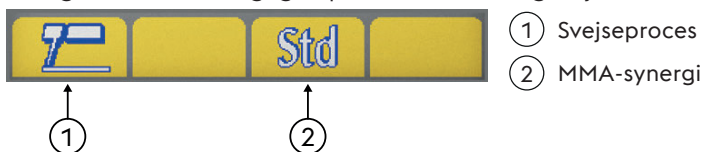

Svejseproces





MMA-synergi

Giver mulighed for at indstille buens dynamik bedst muligt ved at markere den anvendte elektrode type. En korrekt valgt lysbue-dynamik gør det muligt at udnytte anlæggets ydeevne optimalt for at opnå de bedst mulige ydelser ved svejsningen.

Standard (Basisk/Rutil)	Cellulose	Stål	Aluminium	Støbejern



Der garanteres ikke perfekt svejsbarhed af den anvendte elektrode. Svejsbarhed, der afhænger af de nedsmeltende elektrodens kvalitet, deres opbevaring, af de operative funktionsmåder og af svejseforholdene, af de utallige mulige anvendelser...

4.5 Hovedskærm billede TIG proces

- ① Målinger
- ② Vejseparametre
- ③ Funktioner

Målinger

I svejsefaserne vises de reelle strøm- og spændingsmål på LCD displayet.

- ① Svejsestrøm
- ② svejse spænding

Vejseparametre

- ① Vejseparametre
 - ▶ Vælg de ønskede parametre ved at trykke på encoderknappen.
 - ▶ Tilpas værdien for de valgte parametre ved at dreje encoderen.
- ② Parameterikon
- ③ Parameterværdi
- ④ Måleenhed for parameter

Funktioner

Gør det muligt at indstille de vigtigste procesfunktioner og svejsemetoder.

- ① Svejseproces

DA



Svejsesproces

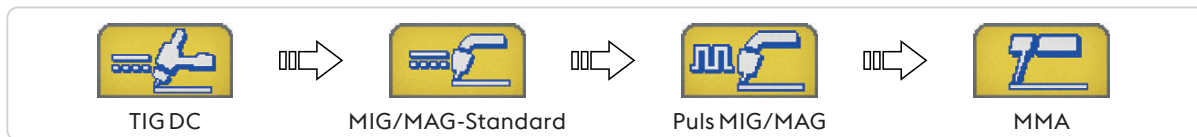

4.6 Hovedskærbillede MIG/MAG proces

Basisskærbillede

① Overskrifter MIG/MAG
 ② Vejseparametre
 ③ Funktioner

Grafisk skærbillede

① Overskrifter MIG/MAG
 ② Vejseparametre
 ③ Funktioner

Overskrifter MIG/MAG

Gør det muligt at se de vigtigste informationer om de valgte processer.

G3/4 Si1 1.0mm Ar 18%CO₂

- ①
- ②
- ③

Valgte synergikurve

- ① Tilsatstrådmateriale
- ② Tråddiameter
- ③ Gastype

I 118A 2.2mm 3.4mm V 19.5V

- ①
- ②
- ③
- ④

Vejseparametre

- ① Svejsestrøm
- ② Arbejdsemnets tykkelse
- ③ Vinkelsvejsning
- ④ svejsespænding

DA

Vejseparametre (Basisskærmbillede)

► Vælg de ønskede parametre ved at trykke på encoderknappen.

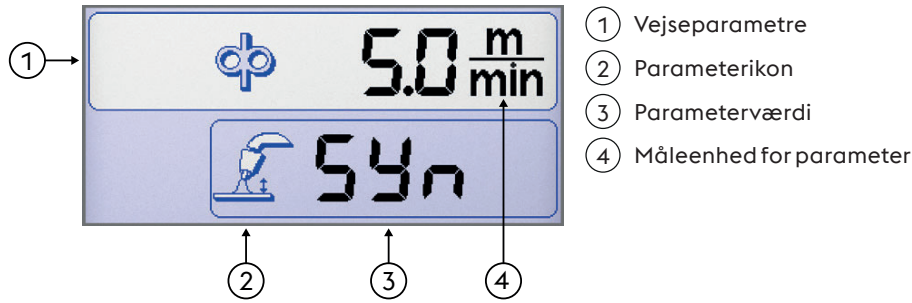

Vejseparametre (Grafisk skærmbillede)

► Vælg de ønskede parametre ved at trykke på encoderknappen.

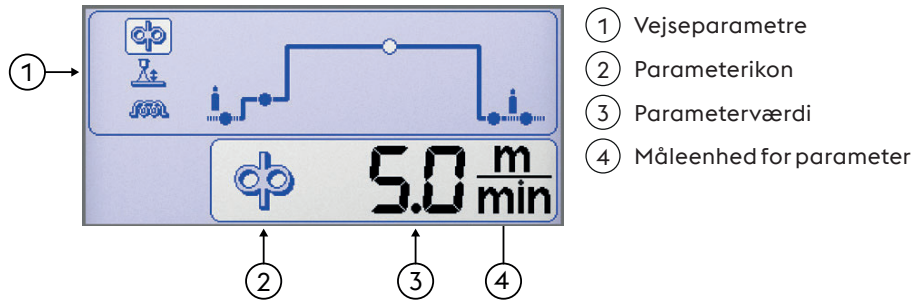

Funktioner

Gør det muligt at indstille de vigtigste procesfunktioner og svejsemetoder.

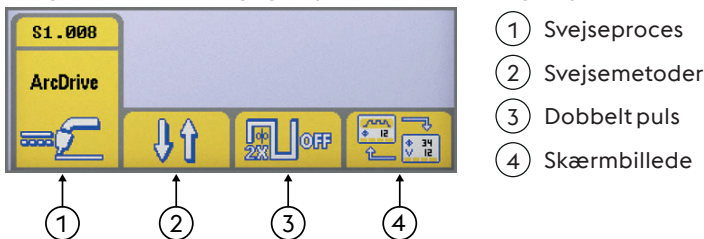

Svejsesproces



Svejsemetoder

Her kan vælges svejsemetode

2 taktr
Et tryk på knappen får gassen til at strømme, tråden tilføres spænding, og den føres frem; når knappen slippes, slukkes der for gassen, og i spændingen.

4 taktr
Det første tryk på knappen får gassen til at strømme med en manuel gasforstrømningstid. Når knappen slippes, aktiveres spændingen. Det efterfølgende tryk på knappen standser tråden og starter den endelige proces, som bringer strømmen tilbage til nul. Når knappen slippes til sidst, slukkes der for gasstrømmen.

Crater filler
Giver mulighed for svejsning med tre forskellige effektive niveauer, som svejseren kan vælge direkte og styre ved hjælp af brænderknappen.

Det første tryk på knappen får gassen til at strømme, aktiverer spændingen til tråden og fører den frem med den hastighed, der er indstillet med parameteren "initial increment" (under opsætningen) og med svejseparametrenes relative synergiværdier.

Når brænderknappen slippes, ændres trådhastigheden og de relative synergiparametre automatisk til de hovedværdier, der er indstillet på kontrolpanelet.

Det næste tryk på brænderknappen bringer trådhastigheden og de relative synergiparametre op på de (under opsætningen) forudindstillede parameterværdier for kraterfylder.

Når brænderknappen slippes, standser trådfremføringen, og der leveres strøm til "burn-back" og gasefterstrømningstakterne.

Dobbelt puls

Dobbelt puls aktiv

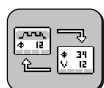

Dobbelt puls ikke aktiv

Skærbillede

Giver mulighed for ændring i visualisering mellem:



Basisskærbillede



Grafisk skærbillede

Synergikurveskærm

Synergi

Gør det muligt at vælge et forud indstillet program (synergi) ved at vælge nogle enkelte oplysninger

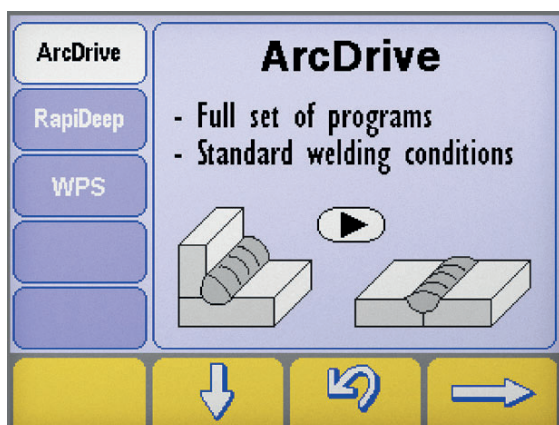
Valg af svejseproces

- ▶ Få adgang til skærbilledet "synergi" ved at trykke knappen i mindst et sekund.
- ▶ Vælg den ønskede proces ved at trykke knapperne e .
- ▶ Tryk knappen for at gå videre til næste trin.

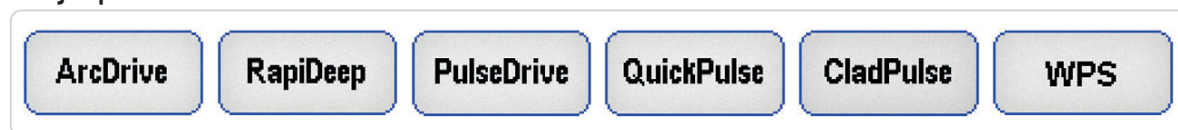
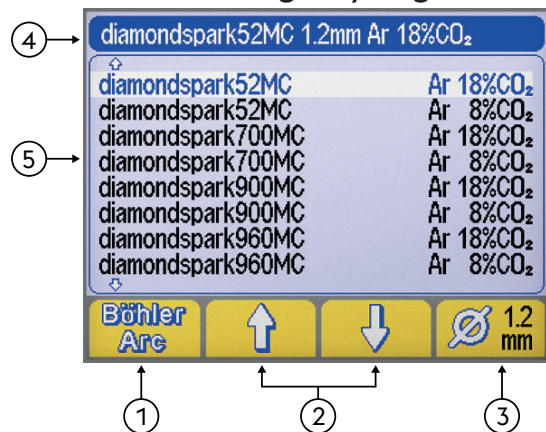
Svejseproces

Skærbillede til valg af synergi materialetype/gastype

- ① Svejseprogram (BöhlerArc/UniversalArc)
- ② Valg af materiale/gas
- ③ Tråddiameter
- ④ Overskrifter
- ⑤ Svejseprogram

Svejseprogram

Her kan vælges svejseprogram



BöhlerArc



UniversalArc

Valg af materiale/gas

Tryk på sektionen:



• Tilsatstrådmateriale



• Gastype

DA



Tråddiameter

Giver mulighed at vælge den anvendte tråddiameter (mm).

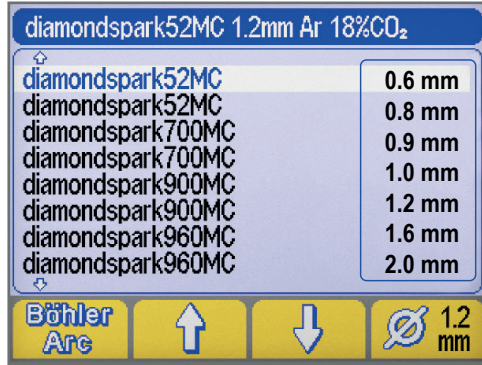

① Tråddiameter

①



Overskrifter

Gør det muligt at se de vigtigste informationer om de valgte processer.



NO PROGRAM

Indikerer, at den valgte synergikurve ikke er tilgængelig eller ikke kan anvendes sammen med systemets øvrige indstillinger.

4.7 Programskærm



Giver mulighed for at lagre og styre 240 svejseprogrammer, som kan operatøren selv kan skræddersy.

Programmer (JOB)

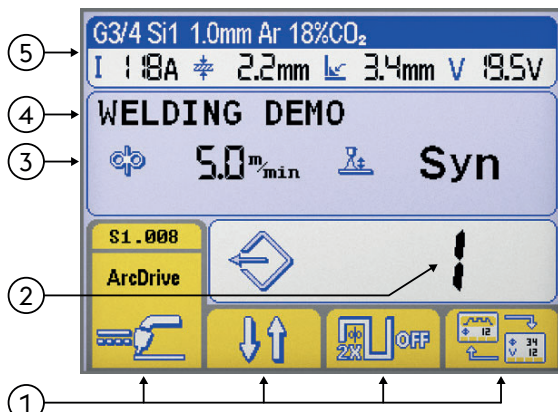

- ① Funktioner
- ② Det valgte programs nummer
- ③ Det valgte programs vigtigste parametre
- ④ Beskrivelse af det valgte program
- ⑤ Overskrifter

DA

Se sektionen "Hovedmenu"

Programlagring



▶ Gå ind på skærbilledet "gem program" ved at trykke på knappen i mindst et sekund.



▶ Vælg det ønskede program (eller en tom hukommelse) ved at dreje encoderen.

--- Tom hukommelse



Gemt program

▶ Godkend ved at trykke på knappen .

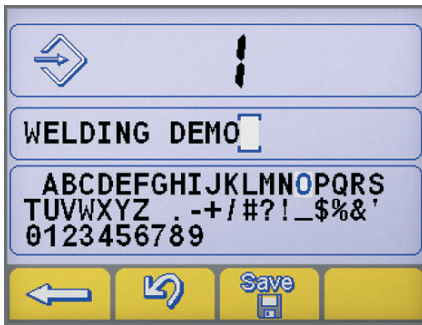
▶ Gem alle eksisterende indstillinger i det valgte program ved at trykke på knappen .





Tilføj en beskrivelse af programmet.

- ▶ Vælg det ønskede bogstav ved at dreje encoderen.
- ▶ Bogstavet lagres ved et tryk på encoderen.
- ▶ Slet det sidste bogstav ved at trykke på knappen. .
- ▶ Godkend ved at trykke på knappen .
- ▶ Godkend ved at trykke på knappen .





Lagringen af et nyt program i en allerede optaget hukommelse medfører sletning af hukommelsen via en obligatorisk procedure.

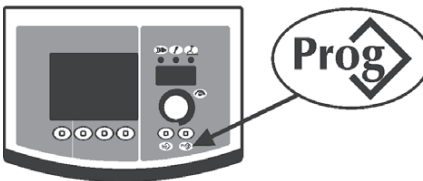

- ▶ Godkend ved at trykke på knappen .
- ▶ Fjern det valgte program ved at trykke på knappen .
- ▶ Genoptag lagringsproceduren.

Hent program





- ▶ Kald det 1 disponible program frem igen ved at trykke på knappen .
- ▶ Vælg det ønskede program ved at dreje encoderen.
- ▶ Vælg det ønskede program ved at trykke på knappen. .





Det er kun hukommelserne, der ligger i et program, der kaldes frem, mens de tomme springes automatisk over.

Slet program



- ▶ Vælg det ønskede program ved at dreje encoderen.
- ▶ Fjern det valgte program ved at trykke på knappen .
- ▶ Godkend ved at trykke på knappen .



- ▶ Godkend ved at trykke på knappen .
- ▶ Fjern det valgte program ved at trykke på knappen .

5. SETUP

5.1 Set-up og indstilling af parametrene

Giver mulighed for indstilling og regulering af en række ekstra parametre til en bedre og mere præcis administration af svejseanlægget.

Parametrene i setup er ordnet i henhold til den valgte svejseproces og har et kodenummer.

Adgang til setup



- ▶ Sker ved at trykke 5 sekunder på encoder-tasten.
- ▶ Indgangen bekræftes af angivelsen 0 på displayet.

Markering og indstilling af det ønskede parameter

- ▶ Opnås ved at dreje på indkodningstasten, indtil det ønskede parameters kodenumber vises.
- ▶ På dette tidspunkt giver et tryk på indkodningstasten mulighed for at få vist og regulere indstillingsværdien for det markerede parameter.

Udgang fra setup

- ▶ Tryk igen på indkodningstasten for at forlade "reguleringssektionen".
- ▶ Man forlader setup ved at gå til parameteret "0" (lagr og luk) og trykke på indkodningstasten.
- ▶ Godkend ved at trykke på knappen .
- ▶ Modifikationen gemmes og man forlader set up ved at trykke på tasten: .

5.1.1 Liste over parametrene i setup (MMA)

0

Lagr og luk

Giver mulighed for at lagre modifikationer og forlade setup.



1

Reset

Giver mulighed for at indstille alle parametrene på defaultværdierne igen.



3

Hot start

Giver mulighed for at regulere hot-start-værdien i MMA.

Herved tillades en mere eller mindre "varm" start under buens tændingsfaser, hvilket reelt letter starthandlingerne.



Basisk elektrode

Minimum	Maksimum	Default
0/off	500%	80%

Cellulose elektrode

Minimum	Maksimum	Default
0/off	500%	150%

CrNi-elektrode

Minimum	Maksimum	Default
0/off	500%	100%

Aluminium elektrode

Minimum	Maksimum	Default
0/off	500%	120%

Støbejernselektrode

Minimum	Maksimum	Default
0/off	500%	100%

7

Svejestrøm

Giver mulighed for at regulere svejestrømmen.



Minimum	Maksimum	Default
3 A	I _{max}	100 A

8 Arc force

Giver mulighed for at indstille værdien på Arc force i MMA.

Herved tillades en mere eller mindre energisk dynamisk respons under svejsning, hvilket reelt letter svejsehandlingerne.

Lysbuens styrkeværdi øges for at mindske risikoen for, at elektroden sidder fast.

Basisk elektrode

Minimum	Maksimum	Default
0/off	500%	30%

Cellulose elektrode

Minimum	Maksimum	Default
0/off	500%	350%

CrNi-elektrode

Minimum	Maksimum	Default
0/off	500%	30%

Aluminium elektrode

Minimum	Maksimum	Default
0/off	500%	100%

Støbejerns elektrode

Minimum	Maksimum	Default
0/off	500%	70%

204 Dynamic power control (DPC)

Gør det muligt at vælge det ønskede forhold mellem spænding og strøm.

I=C **Konstant strøm**

Forøgelse eller mindskelse af lysbuehøjden har ingen indvirkning på den krævede svejsestrøm.

Anbefales til elektrode: Basisk, Rutil, Sur, Stål, Støbejern

1:20 **Karakteristik cadente con regolazione di rampa**

Forøgelse af lysbuehøjden som følge af reduktion i svejsestrømmen (og vice versa) i henhold til den fastsatte værdi ved 1 til 20 ampere pr. volt.

Anbefales til elektrode: Cellulose, Aluminium

P=C **Konstant spænding**

Forøgelse af lysbuehøjden som følge af reduktion i svejsestrømmen (og vice versa) i henhold til formlen: $V \cdot I = K$

Anbefales til elektrode: Cellulose, Aluminium

312 Buens afbrydningspænding

Giver mulighed for at indstille den spændingsværdi, hvor den elektriske bue forceres til at slukke.

Det giver mulighed for bedre at administrere de forskellige driftsforhold, der opstår.

I punktsvejsningsfasen, for eksempel, vil buens lavere afbrydningspænding give mulighed for en mindre lue, når elektroden flyttes væk fra emnet, hvilket reducerer sprutten, brænding og oxidering af emnet.

Hvis der anvendes elektroder, der kræver en høj spænding, er det derimod tilrådeligt at indstille en høj tærskel for at undgå, at buen slukkes under svejsningen.



Indstil aldrig buens afbrydningspænding højere end strømkildens tomgangsspænding.

Basisk elektrode

Minimum	Maksimum	Default
0/off	99.9 V	57.0 V

Cellulose elektrode

Minimum	Maksimum	Default
0/off	99.9 V	70.0 V

399 Forskydningshastighed

Gør det muligt at indstille svejsningens udførelses hastighed.

Default cm/min: referencehastighed for håndsvejsning.

Syn: Sinergic værdi.

Minimum	Maksimum	Default
1 cm/min	200 cm/min	15 cm/min

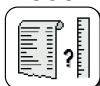
500 Indstilling af maskine

Gør det muligt at vælge den ønskede grafiske interface.

Gør det muligt at få adgang til højere set up-niveauer.

Se under "Skræddersyet interface (Set up 500)"

Værdi	Brugerinterface
XE	Tilstanden Easy
XA	Tilstanden Advanced
XP	Tilstanden Professional

Værdi	Markeret niveau
USER	Bruger
SERV	Service
vaBW	vaBW

551 Lock/unlock



Gør det muligt at låse kontrolpanelets indstillinger og at installere en beskyttelseskode. Se under "Lock/unlock (Set up 551)".

552 Summetone



Giver mulighed for at justere summetonen.

Minimum	Maksimum	Default
0/off	10	10

601 Reguleringstrin



Gør det muligt at regulere et parameter med trin, som man selv kan skræddersy

Minimum	Maksimum	Default
1	Imax	1

602 Ekstern parameter CH1, CH2, CH3, CH4



Gør det muligt at styre den eksterne parameter 1, 2, 3, 4 (minimumværdi, maksimumværdi, defaultværdi, valgte parameter).

Se under "Styring fra eksternt udstyr (Set up 602)".

705 Justering af kredsløbsmodstand



Tillader at kalibrere anlægget.

Se under "Justering af kredsløbsmodstand (set up 705)".

751 Strømaflæsning



Gør det muligt at se den faktiske værdi for svejsestrømmen.

752 Spændings aflæsning



Gør det muligt at aflæse den faktiske værdi for svejse spænding.

768 Måling af tilført termisk energi HI



Tillader aflæsning af værdien på den tilførte termiske energi i svejsningen.

5.1.2 Liste over opsætningsparametre (TIG)

0 Lagr og luk



Giver mulighed for at lagre modifikationer og forlade setup.

1 Reset



Giver mulighed for at indstille alle parametrene på defaultværdierne igen.

7 Svejsestrøm



Giver mulighed for at regulere svejsestrømmen.

Minimum	Maksimum	Default
3 A	Imax	100 A

399 Forskydnings hastighed



Gør det muligt at indstille svejsningens udførelses hastighed.

Default cm/min: referencehastighed for håndsvejsning.

Syn: Sinergic værdi.

Minimum	Maksimum	Default
1 cm/min	200 cm/min	10 cm/min

500 Indstilling af maskine

Gør det muligt at vælge den ønskede grafiske interface.
 Gør det muligt at få adgang til højere set up-niveauer.
 Se under "Skræddersyet interface (Set up 500)"

Værdi	Brugerinterface
XE	Tilstanden Easy
XA	Tilstanden Advanced
XP	Tilstanden Professional

Værdi	Markeret niveau
USER	Bruger
SERV	Service
vaBW	vaBW

551 Lock/unlock

Gør det muligt at låse kontrolpanelets indstillinger og at installere en beskyttelseskode.
 Se under "Lock/unlock (Set up 551)".

552 Summetone

Giver mulighed for at justere summetonen.

Minimum	Maksimum	Default
0/off	10	10

601 Reguleringsstrin

Gør det muligt at regulere et parameter med trin, som man selv kan skræddersy

Minimum	Maksimum	Default
1	Imax	1

602 Ekstern parameter CH1, CH2, CH3, CH4

Gør det muligt at styre den eksterne parameter 1, 2, 3, 4 (minimumværdi, maksimumværdi, defaultværdi, valgte parameter).

Se under "Styring fra eksternt udstyr (Set up 602)".

705 Justering af kredsløbsmodstand

Tillader at kalibrere anlægget.

Se under "Justering af kredsløbsmodstand (set up 705)".

751 Strømaflæsning

Gør det muligt at se den faktiske værdi for svejsestrømmen.

752 Spændingsaflysning

Gør det muligt at aflæse den faktiske værdi for svejse-spænding.

755 Aflæsning af gasflow (WFR)

Gør det muligt at se det reelle gasflow.

757 Trådhastighed

Muliggør visning af værdien for motorindkoder 1.

760 Strømaflæsning (motor 1)

Gør det muligt at se den faktiske værdi for motorstrømmen (motor 1).

764 Aflæsning af kølemedieløbet

Muliggør visning af værdien for kølemedieløbet.

DA

765 Aflæsning af kølemedietemperatur



Gør det muligt at se den faktiske værdi for kølemedietemperatur.

768 Måling af tilført termisk energi HI



Tillader aflæsning af værdien på den tilførte termiske energi i svejsningen.

801 Stopgrænser



Gør det muligt at indstille advarselsværdier og stopværdier.

Gør det muligt at styre svejseprocessen ved at sætte advarselsgrenser og stopgrænser for de vigtigste målbare parametre.

Giver mulighed for nøje styring af de forskellige svejsefaser.

Se under "Stopgrænser (Set up 801)".

5.1.3 Liste over opsætningsparametre (MIG/MAG)

0 Lagr og luk



Giver mulighed for at lagre modifikationer og forlade setup.

1 Reset



Giver mulighed for at indstille alle parametrene på defaultværdierne igen.

2 Synergi



MIG/MAG-Standard:

Giver mulighed for at vælge den manuelle MIG-proces (Off) eller den synergiske MIG-proces (6) ved indstilling af den materialetype, der skal svejdes.

Puls MIG/MAG:

Giver mulighed for at vælge den synergiske MIG-proces (6) ved indstilling af den materialetype, der skal svejdes.

Giver mulighed for at vælge den CC/CV-process.

3 Trådhastighed



Gør det muligt at regulere trådfremføringshastigheden.

Minimum	Maksimum	Default
0.5 m/min	22.0 m/min	-

4 Strøm



Giver mulighed for at regulere svejsestrømmen.

Minimum	Maksimum
3 A	I _{max}

5 Arbejdsemnets tykkelse



Gør det muligt at indstille tykkelsen på det emne, der skal svejdes.

Giver mulighed for at systemet indstilles via regulering af det emne, der p.t. svejdes.

6 Vinkelsvejsning "α"



Gør det muligt at indstille svejsedybden i en vinkelsamling.

7 Spænding - buelængde

Gør det muligt at regulere buespændingen.
 Gør det muligt at regulere buelængden under svejsningen.

Høj spænding = lang bue

Lav spænding = kort bue

Manuelsvejsning

Minimum	Maksimum	Default
5.0 V	55.5 V	5.0 V

10 Præ-gas

Giver mulighed for at indstille og regulere gassens strømning, inden buen tændes.
 Giver mulighed for at fylde gas på brænderen og forberede omgivelserne til svejsningen.

Minimum	Maksimum	Default
0/off	99.9 s	0.1 s

11 Soft start



Giver mulighed for at regulere trådens fremføringshastighed under tændingens forudgående faser.
 Giver mulighed for en tænding ved nedsat hastighed og derved en mere blød tænding med færre stænk.

Minimum	Maksimum	Default
10 %	100 %	50 %

12 Motorrampe

Giver mulighed for at indstille en blød overgang mellem trådens hastighed ved tænding og under svejsning.

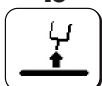
Minimum	Maksimum	Default
0/off	1.0 s	0/off

15 Burn back

Giver mulighed for at regulere trådens brændevarighed, hvorved tilklæbning ved svejsningens afslutning forebygges.

Giver mulighed for at regulere længden på brænderens udvendige stykke tråd.

Minimum	Maksimum	Default
-2.00	+2.00	0/syn

16 Post-gas

Giver mulighed for at regulere gassens strømning ved svejsningens afslutning.

Minimum	Maksimum	Default
0/off	99.9 s	2.0 s

19 Duty cycle (dobbel impuls)

Tillader justering af arbejdscyklus ved dobbelt impuls.

Minimum	Maksimum	Default
10 %	90 %	50 %

20 Dobbelt puls

Gør det muligt at regulere pulsamplitude.

Minimum	Maksimum	Default
0 %	100 %	±25 %

Minimum	Maksimum	Default
0.5 m/min	22 m/min	2.5 m/min

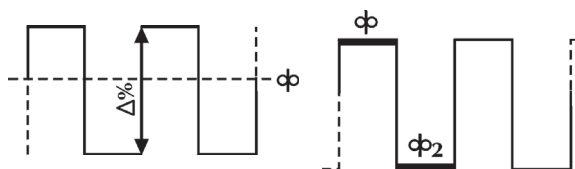
21 Impulsfrekvens (dobbel impuls)

Giver mulighed for at regulere cyklus, dvs. impulsrepetitionscyklus.

Gør det muligt at regulere impulsfrekvens.

Minimum	Maksimum	Default
0.1 Hz	5.0 Hz	2.0 Hz

22 Sekundær spænding (dobbel impuls)



Gør det muligt at regulere spændingen for det sekundære puls niveau.
Gør det muligt at opnå en større buestabilitet under de forskellige pulsfaser.

Minimum	Maksimum	Default
-5.0	+5.0	0/syn

23 Impulsmoduleret stigning/sænkning (dobbel impuls)



Tillader indstillingen af en rampetid i pulseringsfasen.

Minimum	Maksimum	Default
1 %	100 %	50 %

24 Bilevel (4T - crater filler)



Giver mulighed for at regulere den sekundære trådhastighed i tilstanden toplanssvejsning.

Hvis man trykker og slipper trykknappen i hurtig rækkefølge, skifter man til "Φ₂".

Hvis man igen trykker og slipper trykknappen i hurtig rækkefølge, skifter man igen til "Φ" og så videre.

Minimum	Maksimum	Default
1 %	200 %	0/off

25 Startfasen



Gør det muligt at regulere trådhastigheden i den første "kraterfyldnings" svejsfase.

Gør det muligt at øge energitilførslen til emnet i den første fase, hvor materialet stadig er koldt og derfor har brug for højere temperatur for at smelte jævnt.

Minimum	Maksimum	Default
20 %	200 %	120 %

26 Crater filler



Gør det muligt at regulere trådhastigheden under svejsningens afsluttende fase.

Gør det muligt at mindske den energi, der tilføres emnet i den fase, hvor materialet er allerede meget varmt, hvorved risikoen for uønskede deformiteter mindskes.

Minimum	Maksimum	Default
20 %	200 %	80 %

27 Tidsindstilling for startforøgelse



Gør det muligt at indstille startforøgelsen.

Gør det muligt at automatisere funktionen "crater filler".

Minimum	Maksimum	Default
0.1 s	99.9 s	0/off

28 Tidsindstilling for crater filler



Gør det muligt at indstille "crater filler"-tiden.

Gør det muligt at automatisere funktionen "crater filler".

Minimum	Maksimum	Default
0.1 s	99.9 s	0/off

30 Punktsvejsning



Giver mulighed for at aktivere processen "punktsvejsning" og for at fastlægge svejsningens varighed.

Minimum	Maksimum	Default
0.1 s	99.9 s	0/off

31 Pausepunkt



Giver mulighed for at aktivere processen "pausepunkt" og fastlægge opholdstidsrummet mellem to svejsninger.

Minimum	Maksimum	Default
0.1 s	99.9 s	0/off

32 Sekundær spænding (Toplans MIG)

Gør det muligt at regulere spændingen for det sekundære puls niveau.
 Gør det muligt at opnå en større buestabilitet under de forskellige pulsfaser.

Minimum	Maksimum	Default
-5.0	+5.0	0/syn

33 Sekundær induktans (Toplans MIG)

Gør det muligt at regulere induktans for det sekundære puls niveau.
 Gør det muligt at få en hurtigere eller langsommere bue for at kompensere for svejserens bevægelser og for den naturlige ustabilitet ved svejsning.

Lav induktans = reaktiv bue (mere sprøjt).
 Høj induktans = mindre reaktiv bue (mindre sprøjt).

Minimum	Maksimum	Default
-30	+30	0/syn

34 Indledende øgningstakt

Muliggør indstilling af gradvis overgang mellem indledende trådhastighed og trådhastighed under svejsning.

Minimum	Maksimum	Default
0 s	10 s	0/off

35 Kraterfyldningstakt

Muliggør indstilling af gradvis overgang mellem trådhastighed under svejsning og trådhastighed under kraterfyldning.

Minimum	Maksimum	Default
0 s	10 s	0/off

202 Induktans

Gør elektronisk regulering af serieinduktans i svejsekredsløbet mulig.
 Gør det muligt at få en hurtigere eller langsommere bue for at kompensere for svejserens bevægelser og for den naturlige ustabilitet ved svejsning.

Lav induktans = reaktiv bue (mere sprøjt).
 Høj induktans = mindre reaktiv bue (mindre sprøjt).

Minimum	Maksimum	Default
-30	+30	0/syn

331 Kompenseret mellemspænding

Gør det muligt at indstille svejse spændingen.

399 Forskydnings hastighed

Gør det muligt at indstille svejsningens udførelses hastighed.
 Default cm/min: referencehastighed for håndsvejsning.
 Syn: Sinergic værdi.

Minimum	Maksimum	Default
syn min	syn max	35 cm/min

500 Indstilling af maskine

Gør det muligt at vælge den ønskede grafiske interface.
 Gør det muligt at få adgang til højere set up-niveauer.
 Se under "Skræddersyet interface (Set up 500)"

Værdi	Brugerinterface	Værdi	Markeret niveau
XE	Tilstanden Easy	USER	Bruger
XA	Tilstanden Advanced	SERV	Service
XP	Tilstanden Professional	vaBW	vaBW

551 Lock/unlock

Gør det muligt at låse kontrolpanelets indstillinger og at installere en beskyttelseskode.
 Se under "Lock/unlock (Set up 551)".

DA

552 Summetone



Giver mulighed for at justere summetonen.

Minimum	Maksimum	Default
0/off	10	10

601 Reguleringstrin



Gør det muligt at regulere et parameter med trin, som man selv kan skræddersy
Funktionalitet styret af knap op / ned knap.

Minimum	Maksimum	Default
1	Imax	1

602 Ekstern parameter CH1, CH2, CH3, CH4



Gør det muligt at styre den eksterne parameter 1, 2, 3, 4 (minimumværdi, maksimumværdi, defaultværdi, valgte parameter).

Se under "Styring fra eksternt udstyr (Set up 602)".

606 Brænder U/D



Gør det muligt at styre den eksterne parameter (U/D).

Værdi	Default	Tilbagekaldsfunktion
0/off	-	off
1/11	X	Strøm
	-	Hent program

705 Justering af kredsløbsmodstand



Tillader at kalibrere anlægget.

Se under "Justering af kredsløbsmodstand (set up 705)".

751 Strømaflæsning



Gør det muligt at se den faktiske værdi for svejsestrømmen.

752 Spændings aflæsning



Gør det muligt at aflæse den faktiske værdi for svejse spænding.

755 Aflæsning af gasflow (WFR)



Gør det muligt at se det reelle gasflow.

757 Trådhastighed



Muliggør visning af værdien for motorinkoder 1.

758 Robothastighed



Gør det muligt at aflæse hastigheden for en robotarm eller andet automationudstyr.

760 Strømaflæsning (motor 1)



Gør det muligt at se den faktiske værdi for motorstrømmen (motor 1).

761 Trådhastighed



Muliggør visning af værdien for motorinkoder 2.

762 Strømaflæsning (motor 2)

Gør det muligt at se den faktiske værdi for motorstrømmen (motor 2).

763 Tråd hastighed

Muliggør visning af reel værdi for trådhastigheden.

764 Aflæsning af kølemedieløst

Muliggør visning af værdien for kølemedieløstet.

765 Aflæsning af kølemedietemperatur

Gør det muligt at se den faktiske værdi for kølemedietemperatur.

768 Måling af tilført termisk energi HI

Tillader aflæsning af værdien på den tilførte termiske energi i svejsningen.

801 Stopgrænser

Gør det muligt at indstille advarselværdier og stopværdier.

Gør det muligt at styre svejseprocessen ved at sætte advarselgrænser og stopgrænser for de vigtigste målbare parametre.

Giver mulighed for nøje styring af de forskellige svejsefaser.



Se under "Stopgrænser (Set up 801)".

5.2 Specifikke procedurer for brug af parametrene

5.2.1 Skræddersy 7-segment displayet

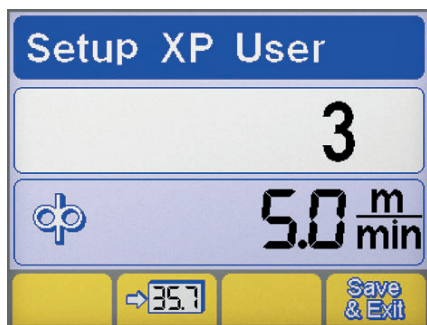
Giver mulighed for konstant at visualisere en parameterværdi på displayet med 7 segmenter.



- ▶ Gå ind i opsætning ved at holde encoderknappen nede i mindst 5 sekunder.
- ▶ Vælg det ønskede parameter ved at dreje encoderen.
- ▶ Gem det valgte parameter i 7-segment displayet ved at trykke på knappen .
- ▶ Gem og gå ud af skærbilledet ved at trykke på knappen .

5.2.2 Skræddersyet interface (Set up 500)

Gør det muligt med personlig tilpasning af parametrene i hovedskærbilledet.

500 Indstilling af maskine

Gør det muligt at vælge den ønskede grafiske interface.

Værdi	Brugerinterface
XE	Tilstanden Easy
XA	Tilstanden Advanced
XP	Tilstanden Professional

TILSTAND XE

MMA

Vejseparametre



TIG	
Vejseparametre	
Funktioner	

TILSTAND XA

MMA	
Vejseparametre	
Funktioner	

TIG	
Vejseparametre	
Funktioner	

MIG/MAG	
Vejseparametre	
Funktioner	

TILSTAND XP

MMA	
Vejseparametre	
Funktioner	

TIG	
Vejseparametre	
Funktioner	

MIG/MAG	
Vejseparametre	
Funktioner	

DA

5.2.3 Lock/unlock (Set up 551)

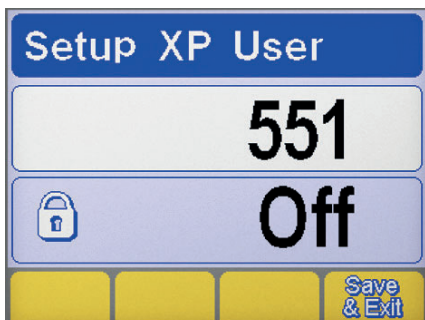

Gør det muligt at låse kontrolpanelets indstillinger og at installere en beskyttelseskode.

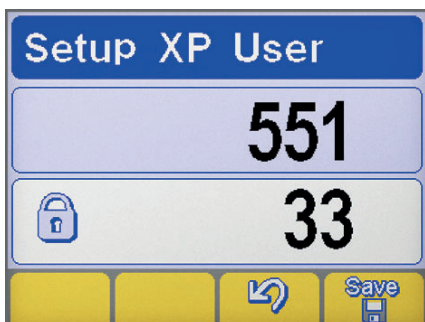

Parametermarkering

- ▶ Gå ind i opsætning ved at holde encoderknappen nede i mindst 5 sekunder.
- ▶ Vælg den ønskede parameter (551).
- ▶ Aktiver regulering af det valgte parameter ved at trykke på encoderknappen.





- ▶ Definer en numerisk kode (password) ved at dreje på encoderen.
- ▶ Bekræft handlingen ved at trykke på encoder-tasten.
- ▶ Godkend ved at trykke på knappen .
- ▶ Modifikationen gemmes ved at trykke på knappen: .

Panelfunktioner

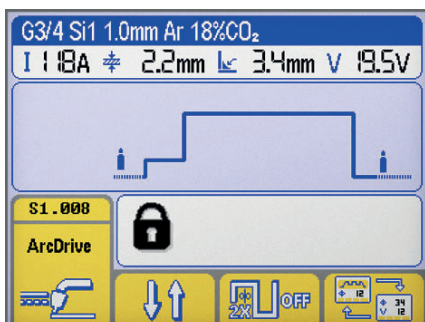

Når en opgave udføres på et låst kontrolpanel, kommer der et specielt skærbillede frem.



- ▶ Gå ind i panelfunktionerne midlertidigt (5 minutter) ved at dreje endoceren og indtaste gyldigt password.
- ▶ Bekræft handlingen ved at trykke på encoder-tasten.
- ▶ Lås kontrolpanelet endeligt op ved at gå ind i opsætning (følg instrukserne ovenfor) og sæt parameter 551 tilbage på "off".
- ▶ Bekræft handlingen ved at trykke på encoder-tasten.
- ▶ Modifikationen gemmes ved at trykke på knappen: .

5.2.4 Styring fra eksternt udstyr (Set up 602)

Gør det muligt at styre den eksterne parameter 2 (minimumværdi, maksimumværdi, defaultværdi, valgte parameter).

Parametermarkering



- ▶ Gå ind i opsætning ved at holde encoderknappen nede i mindst 5 sekunder.
- ▶ Vælg den ønskede parameter (602).
- ▶ Gå ind i "Styring fra eksternt udstyr" skærmen ved at trykke på encoderknappen.

Styring fra eksternt udstyr

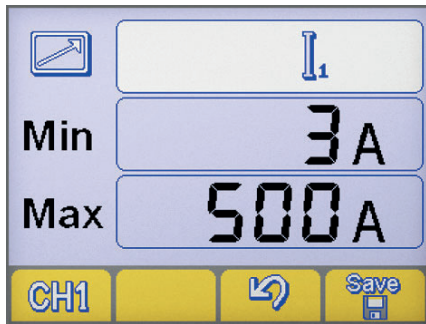

- ▶ Vælg den ønskede udgangskanal på fjernbetjeningen (CH1, CH2, CH3, CH4) ved at trykke på-knappen.
- ▶ Vælg det ønskede parameter (Min-Max-parameter) ved at trykke på encoderknappen.
- ▶ Tilpas det valgte parameter (Min-Max-parameter) ved at dreje encodern.
- ▶ Modifikationen gemmes ved at trykke på knappen:
- ▶ Godkend ved at trykke på knappen

5.2.5 Justering af kredsløbsmodstand (set up 705)

Giver mulighed for at kalibrere generatoren på det aktuelle svejsekredsløbs modstand.

Parametermarkering

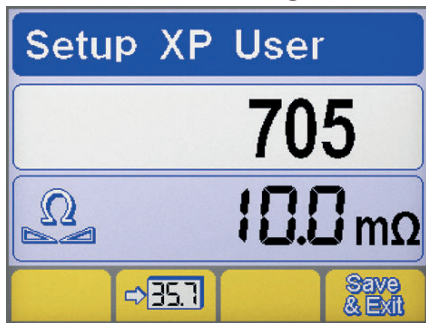

- ▶ Gå ind i opsætning ved at holde encoderknappen nede i mindst 5 sekunder.
- ▶ Vælg den ønskede parameter (705).
- ▶ Aktiver regulering af det valgte parameter ved at trykke på encoderknappen.
- ▶ Forbind generatoren til svejsekredsløbet (bænk eller emne).
- ▶ Tag hættten af for at blotlægge brænderens dyseholder. (MIG/MAG)

Kalibrering

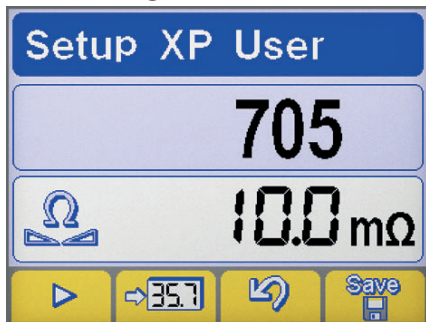

- ▶ Bring trådføreren og det emne, som skal svejses, i elektrisk kontakt. (MIG/MAG)
- ▶ Tryk på knappen for at starte proceduren.
- ▶ Oprethold kontakten i mindst et sekund.
- ▶ Den viste værdi på displayet opdateres efter kalibreringen.
- ▶ Godkend ved at trykke på knappen
- ▶ Godkend ved at trykke på knappen
- ▶ Modifikationen gemmes og man forlader set up ved at trykke på tasten:

5.2.6 Stopgrænser (Set up 801)

Gør det muligt at indstille advarselsværdier og stopværdier.

Gør det muligt at styre svejseprocessen ved at sætte advarselgrænser og stopgrænser for de vigtigste målbare parametre.

Giver mulighed for nøje styring af de forskellige svejsefaser.

Advarselsgrænser		MIN	MAX	Stopgrænser		MIN	MAX
	Svejestrøm						
	Aflæsning af gasflow						
	Strømaflæsning (motor 1)						
	Aflæsning af kølemedieflow						
	Aflæsning af kølemedietemperatur						

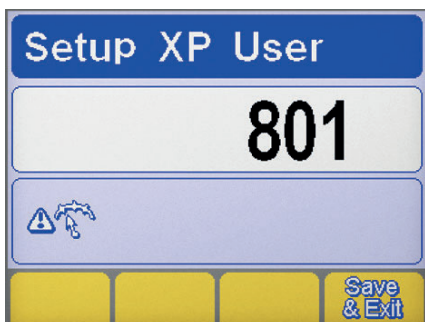
Parametermarkering

- ▶ Gå ind i opsætning ved at holde encoderknappen nede i mindst 5 sekunder.
- ▶ Vælg den ønskede parameter (801).
- ▶ Gå ind i "Stopgrænser" skærbilledet ved at trykke på encoderknappen.

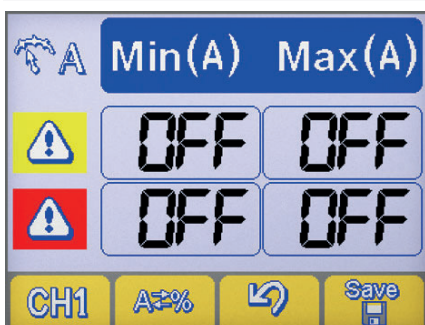
Markering af parameteren

- ▶ Vælg det ønskede parameter ved at trykke på knappen **CH1**.
- ▶ Vælg metode til at indstille stopgrænser ved at trykke på knappen **A=%**.

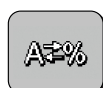
Indstilling af maskine



Absolut værdi

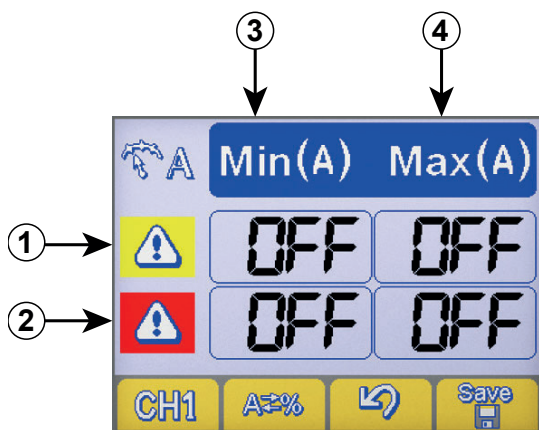

Procentværdi

Indstilling af beskyttelsesgrænser

- ① Advarselsgrænselinje
- ② Alarmgrænselinje
- ③ Minimum-niveau søjle
- ④ Maksimum-niveau søjle

- ▶ Vælg den ønskede boks ved at trykke på encoderknappen (den valgte boks vises med modsat kontrast).
- ▶ Tilpas niveauet for den valgte grænse ved at dreje encoderen.
- ▶ Modifikationen gemmes ved at trykke på knappen: .



Hvis en af advarselsgrænserne overskrives, vil et signal kunne ses på kontrolpanelet.



Hvis en af alarmgrænserne overskrides, vil et signal kunne ses på kontrolpanelet, og svejsningen blokeres omgående.



Det er muligt at indstille start og slut svejsfiltrer, for at forhindre at fejlsignal går i gang, når buen hhv. tændes og slukkes (se under "Opsætning" - Parameter 802-803-804).

DA

6. VEDLIGEHOELDELSE



Anlægget skal undergå en rutinemæssig vedligeholdelse i henhold til fabrikantens anvisninger. Alle adgangslåger, åbninger og dæksler skal være lukket og korrekt fastgjort, når apparatet er i funktion. Der må aldrig udføres nogen form for ændringer på anlægget. Undgå ophobning af metalstøv i nærheden af eller direkte på udluftningsvingerne.



Al vedligeholdelse skal udelukkende udføres af kvalificeret personale. Reparation eller udskiftning af anlægselementer udført af uautoriseret personale medfører øjeblikkeligt bortfald af produktgarantien. Eventuel reparation eller udskiftning af anlægselementer må udelukkende udføres af teknisk kvalificeret personale.



Afbryd strømforsyningen til anlægget inden enhver form for indgreb!

6.1 Regelmæssig kontrol af strømkilden

6.1.1 Оборудование



Rengør strømkilden indvendigt ved hjælp af trykluft med lavt tryk og bløde børster. Kontrollér de elektriske tilslutninger og alle forbindelseskabler.

6.1.2 Ved vedligeholdelse eller udskiftning af komponenter i brænderne, i elektrodeholdertangen og/eller jordledningskablerne skal nedenstående fremgangsmåde overholdes:



Kontrollér temperaturen på komponenterne og sørg for, at de ikke er overopvarmet.



Anvend altid handsker, der opfylder sikkerhedsreglerne.



Anvend egnede nøgler og værktøj.

6.2 ОТВЕТСТВЕННОСТЬ



Ved manglende udførelse af ovennævnte vedligeholdelse vil alle garantier bortfalde, og fabrikanten vil i alle tilfælde være fritaget for alle former for ansvar. Fabrikanten fralægger sig ethvert ansvar, hvis operatøren ikke overholder disse forskrifter. Ret henvendelse til det nærmeste servicecenter ved enhver tvivl og/eller ethvert problem.

7. ALARMKODER



ALARM

Indgriben fra en alarm eller overskridelsen af en kritisk beskyttelsesgrænse forårsager et visuelt signal på kontrolpanelet og den øjeblikkelige blokering af svejsningen.









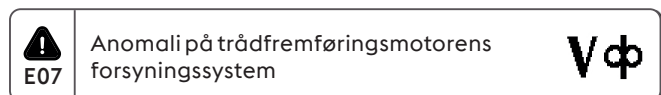
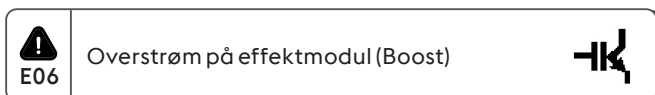





















PAS PÅ

Indgriben fra en alarm eller overskridelsen af en kritisk beskyttelsesgrænse forårsager et visuelt signal på kontrolpanelet og den øjeblikkelige blokering af svejsningen.

Alle alarmer og alle beskyttelsesgrænser for systemet er angivet nedenfor.



 E08	Moteur bloqué		 E10	Overstrøm på effektmodul (Inverter)	
 E11	Forkert konfiguration af anlæg		 E12	Kommunikationsfejl (WF - DSP)	
 E13	Kommunikationsfejl		 E14	Ugyldigt program	
 E15	Ugyldigt program		 E16	Kommunikationsfejl (RI) (Automation og robotstyring)	
 E17	Kommunikationsfejl (µP-DSP)		 E18	Ugyldigt program	
 E19	Forkert konfiguration af anlæg		 E20	Hukommelse defekt	
 E21	Tab af data		 E22	Kommunikationsfejl (DSP)	
 E29	Inkompatible mål		 E30	Kommunikationsfejl (H.F.)	
 E32	Tab af data		 E38	Underspænding	
 E39	Anomali på anlæggets forsyning		 E40	Anomali på anlæggets forsyning	
 E43	Kølevæskemangel		 E48	Trådmangel (Automation og robotstyring)	
 E49	Nødafbryder (Automation og robotstyring)		 E50	Sammenklistret tråd (Automation og robotstyring)	
 E51	Ikke understøttede indstillinger (Automation og robotstyring)		 E52	Antikollision (Automation og robotstyring)	
 E53	Fejl, ekstern flowmåler (Automation og robotstyring)		 E54	Strømniveau overskredet (Nedre grænse)	
 E55	Strømniveau overskredet (Øvre grænse)		 E56	Overskredet spændingsniveau (Nedre grænse)	
 E57	Overskredet spændingsniveau (Øvre grænse)		 E60	Overskredet hastighedsgrænse (Nedre grænse)	
 E61	Overskredet hastighedsgrænse (Øvre grænse)		 E62	Strømniveau overskredet (Nedre grænse)	

 E63	Strømniveau overskredet (Øvre grænse)		 E64	Overskredet spændingsniveau (Nedre grænse)	
 E65	Overskredet spændingsniveau (Øvre grænse)		 E68	Overskredet hastighedsgrænse (Nedre grænse)	
 E69	Overskredet hastighedsgrænse (Øvre grænse)		 E70	Indstilling af inkompatible beskyttelsesgrænser	
 E71	Kølevæskeovertemperatur		 E72	Overstrøm push-pull-motor	
 E73	Overskredet trådhastighedsgrænse (speed meter)		 E74	Overskredet motorstrømniveau 1	
 E75	Overskredet motorstrømniveau 2		 E76	Overskredet kølevæskeflowniveau	
 E77	Kølevæsketemperaturniveau		 E78	Aktiv vedligeholdelse (Automation og robotstyring)	

8. FEJLFINDING OG LØSNINGER

Manglende tænding af anlægget (grøn kontrollampe slukket)

Årsag

- » Manglende ledningsnetsspænding i forsyningsstikket.
- » Defekt forsyningsstik eller -ledning.
- » Brændt linjesikring.
- » Defekt tændingskontakt.
- » Tilslutning mellem vogn til trådtræk og generator ikke korrekt eller defekt.
- » Defekt elektronik.

Løsning

- » Udfør en kontrol og foretag en reparation af det elektriske anlæg.
- » Benyt kun specialiseret personale.
- » Udskift den defekte komponent.
- » Kontakt nærmeste servicecenter og lad anlægget reparere.
- » Udskift den defekte komponent.
- » Udskift den defekte komponent.
- » Kontakt nærmeste servicecenter og lad anlægget reparere.
- » Kontrollér den korrekte tilslutning af anlæggets dele.
- » Kontakt nærmeste servicecenter og lad anlægget reparere.

Manglende udgangseffekt (anlægget svejser ikke)

Årsag

- » Fejlbehæftet brænderknop.
- » Overophedet anlæg (termisk alarm - gul kontrollampe tændt).
- » Åben sideafskærmning eller defekt lågeafbryder.
- » Ukorrekt tilslutning af jordforbindelsen.
- » Ledningsnetsspænding over interval (gul kontrollampe tændt).
- » Defekt elektronik.

Løsning

- » Udskift den defekte komponent.
- » Kontakt nærmeste servicecenter og lad anlægget reparere.
- » Afvent at anlægget køler af uden at slukke det.
- » Det er nødvendigt for operatørsikkerheden, at sidepanelet er lukket under svejsefaserne.
- » Udskift den defekte komponent.
- » Kontakt nærmeste servicecenter og lad anlægget reparere.
- » Udfør jordforbindelsestilslutningen korrekt.
- » Jævnfør afsnittet "Installation".
- » Bring ledningsnetsspændingen tilbage i strømkildens forsyningsinterval.
- » Udfør en korrekt tilslutning af anlægget.
- » Jævnfør afsnittet "Tilslutning".
- » Kontakt nærmeste servicecenter og lad anlægget reparere.

Ukorrekt effektlevering
Årsag

- » Fejlagtig markering af svejseprocessen eller defekt omskifter.

- » Fejlagtig indstilling af systemets parametre eller funktioner.

- » Defekt potentiometer/encoder til regulering af svejsestrøm.

- » Ledningsnetsspænding over interval.

- » Mangel af en fase.

- » Defekt elektronik.

Løsning

- » Udfør en korrekt markering af svejseprocessen.
- » Udskift den defekte komponent.
- » Kontakt nærmeste servicecenter og lad anlægget reparere.

- » Nulstil systemet og indstil svejseparametrene igen.

- » Udskift den defekte komponent.
- » Kontakt nærmeste servicecenter og lad anlægget reparere.

- » Udfør en korrekt tilslutning af anlægget.
- » Jævnfør afsnittet "Tilslutning".

- » Udfør en korrekt tilslutning af anlægget.
- » Jævnfør afsnittet "Tilslutning".

- » Kontakt nærmeste servicecenter og lad anlægget reparere.

Blokeret trådfremføring
Årsag

- » Fejlbehæftet brænderknap.

- » Ukorrekte eller nedslidte valser.

- » Defekt trådfremfører.

- » Beskadiget brænderbeklædning.

- » Trådtræk uden forsyning.

- » Irregulær opvikling på spolen.

- » Sammenbrændt svejsegyde (sammensmeltet tråd).

Løsning

- » Udskift den defekte komponent.
- » Kontakt nærmeste servicecenter og lad anlægget reparere.

- » Udskift valserne.

- » Udskift den defekte komponent.
- » Kontakt nærmeste servicecenter og lad anlægget reparere.

- » Udskift den defekte komponent.
- » Kontakt nærmeste servicecenter og lad anlægget reparere.

- » Kontroller tilslutningen til strømkilden.
- » Jævnfør afsnittet "Tilslutning".
- » Kontakt nærmeste servicecenter og lad anlægget reparere.

- » Genopret spolens normale vikleforhold eller skift den ud.

- » Udskift den defekte komponent.

Ujævn trådfremføring
Årsag

- » Fejlbehæftet brænderknap.

- » Ukorrekte eller nedslidte valser.

- » Defekt trådfremfører.

- » Beskadiget brænderbeklædning.

- » Dårligt justeret spoleholderkobling eller valseblokeringsanordning.

Løsning

- » Udskift den defekte komponent.
- » Kontakt nærmeste servicecenter og lad anlægget reparere.

- » Udskift valserne.

- » Udskift den defekte komponent.
- » Kontakt nærmeste servicecenter og lad anlægget reparere.

- » Udskift den defekte komponent.
- » Kontakt nærmeste servicecenter og lad anlægget reparere.

- » Løsn koblingen.
- » Forøg trykket på valserne.

Ustabil bue
Årsag

- » Utilstrækkelig gasbeskyttelse.

- » Fugtighedsforekomst i svejsegassen.

- » Ukorrekte svejseparametre.

Løsning

- » Juster gasstrømmen.
- » Kontroller, at brænderens spredning og gasgyde er i god stand.

- » Benyt altid produkter og materialer af god kvalitet.
- » Sørg for at holde gasforsyningsanlægget i perfekt stand.

- » Udfør en omhyggelig kontrol af svejseanlægget.
- » Kontakt nærmeste servicecenter og lad anlægget reparere.

Overdreven sprøjt-udslyngning

Årsag	Løsning
» Ukorrekt buelængde.	» Reducer afstanden mellem elektrode og emne.
	» Reducer svejse-spændingen.
» Ukorrekte svejseparametre.	» Reducer svejsestrømmen.
» Utilstrækkelig gasbeskyttelse.	» Juster gasstrømmen.
	» Kontroller, at brænderens spredning og gasdyse er i god stand.
» Ukorrekt buedynamik.	» Forøg kredsløbets induktive værdi.
	» Benyt et udtag med højere induktans.
» Ukorrekt svejseafviklingstilstand.	» Reducer brænderens hældning.

Utilstrækkelig gennemtrængning

Årsag	Løsning
» Ukorrekt svejseafviklingstilstand.	» Reducer fremføringshastigheden under svejsning.
» Ukorrekte svejseparametre.	» Forøg svejse-/skærestrømmen.
» Uegnet elektrode.	» Benyt en elektrode med en mindre diameter.
» Ukorrekt forberedelse af kanterne.	» Forøg spaltens åbning.
» Ukorrekt tilslutning af jordforbindelsen.	» Udfør jordforbindelsestilslutningen korrekt.
	» Jævnfør afsnittet "Installation".
» Emnerne, der skal svejses, er for store.	» Forøg svejse-/skærestrømmen.

Slaggeindslutning

Årsag	Løsning
» Ukomplet bortbearbejdning af slaggen.	» Udfør en omhyggelig rengøring af emnet, inden svejsningen udføres.
» Elektrodens diameter er for stor.	» Benyt en elektrode med en mindre diameter.
» Ukorrekt forberedelse af kanterne.	» Forøg spaltens åbning.
» Ukorrekt svejseafviklingstilstand.	» Reducer afstanden mellem elektrode og emne.
	» Sørg for, at fremføringen er regelmæssig under alle svejsefaserne.

Tungsteninklusion

Årsag	Løsning
» Ukorrekte svejseparametre.	» Reducer svejsestrømmen.
	» Benyt en elektrode med en større diameter.
» Uegnet elektrode.	» Benyt altid produkter og materialer af god kvalitet.
	» Udfør en korrekt slibning af elektroden.
» Ukorrekt svejseafviklingstilstand.	» Undgå berøringer mellem elektrode og svejsebad.

Blæsning

Årsag	Løsning
» Utilstrækkelig gasbeskyttelse.	» Juster gasstrømmen.
	» Kontroller, at brænderens spredning og gasdyse er i god stand.

Sammensmeltning

Årsag	Løsning
» Ukorrekt buelængde.	» Forøg afstanden mellem elektrode og emne.
	» Forøg svejse-spændingen.
» Ukorrekte svejseparametre.	» Forøg svejse-/skærestrømmen.
	» Forøg svejse-spændingen.
» Ukorrekt svejseafviklingstilstand.	» Tilpas vinklen på brænderens hældning.
» Emnerne, der skal svejses, er for store.	» Forøg svejse-/skærestrømmen.
» Ukorrekt buedynamik.	» Forøg kredsløbets induktive værdi.
	» Benyt et udtag med højere induktans.

Marginale graveringer

Årsag	Løsning
» Ukorrekte svejseparametre.	» Reducer svejsestrømmen. » Benyt en elektrode med en mindre diameter.
» Ukorrekt buelængde.	» Reducer afstanden mellem elektrode og emne. » Reducer svejsestrømmen.
» Ukorrekt svejseafviklingstilstand.	» Reducer sideoscillationshastigheden under påfyldning. » Reducer fremføringshastigheden under svejsning.
» Utilstrækkelig gasbeskyttelse.	» Benyt gas, der passer til det materiale, der skal svejdes.

Oxideringer

Årsag	Løsning
» Utilstrækkelig gasbeskyttelse.	» Juster gasstrømmen. » Kontroller, at brænderens spreder og gasdyse er i god stand.

Porøsitet

Årsag	Løsning
» Tilstedeværelse af fedt, maling, rust eller snavs på de emner, der skal svejdes.	» Udfør en omhyggelig rengøring af emnet, inden svejsningen udføres.
» Tilstedeværelse af fedt, maling, rust eller snavs på tilsatsmaterialet.	» Benyt altid produkter og materialer af god kvalitet. » Hold altid tilsatsmaterialet i perfekt stand.
» Fugtighedsforekomst i tilsatsmaterialet.	» Benyt altid produkter og materialer af god kvalitet. » Hold altid tilsatsmaterialet i perfekt stand.
» Ukorrekt buelængde.	» Reducer afstanden mellem elektrode og emne. » Reducer svejsestrømmen.
» Fugtighedsforekomst i svejsegassen.	» Benyt altid produkter og materialer af god kvalitet. » Sørg for at holde gasforsyningsanlægget i perfekt stand.
» Utilstrækkelig gasbeskyttelse.	» Juster gasstrømmen. » Kontroller, at brænderens spreder og gasdyse er i god stand.
» For hurtig størkning af svejsebadet.	» Reducer fremføringshastigheden under svejsning. » Udfør en forvarmning af de emner, der skal svejdes. » Forøg svejse-/skærestrømmen.

Knagelyd ved opvarmning

Årsag	Løsning
» Ukorrekte svejseparametre.	» Reducer svejsestrømmen. » Benyt en elektrode med en mindre diameter.
» Tilstedeværelse af fedt, maling, rust eller snavs på de emner, der skal svejdes.	» Udfør en omhyggelig rengøring af emnet, inden svejsningen udføres.
» Tilstedeværelse af fedt, maling, rust eller snavs på tilsatsmaterialet.	» Benyt altid produkter og materialer af god kvalitet. » Hold altid tilsatsmaterialet i perfekt stand.
» Ukorrekt svejseafviklingstilstand.	» Udfør de korrekte driftssekvenser til den sammenføjning, der skal svejdes.
» De emner, der skal svejdes, har forskellige egenskaber.	» Udfør en indsmøring, inden svejsningen udføres.

Knagelyd ved kolde emner

Årsag	Løsning
» Fugtighedsforekomst i tilsatsmaterialet.	» Benyt altid produkter og materialer af god kvalitet. » Hold altid tilsatsmaterialet i perfekt stand.
» Partikulær geometri i den sammenføjning, der skal svejdes.	» Udfør en forvarmning af de emner, der skal svejdes. » Udfør en eftervarmning. » Udfør de korrekte driftssekvenser til den sammenføjning, der skal svejdes.

9. GODE RÅD OM SVEJSNING I

9.1 Svejsning med beklædt elektrode (MMA)

Forberedelse af kanterne

For at opnå gode resultater anbefales det at arbejde på rene dele uden oxydering, rust eller andre forurenende stoffer.

Valg af elektroden

Diameteren på den elektrode, der skal anvendes, afhænger af materialets tykkelse, af positionen, af sammenføjningstypen og af svejsefugen. Elektroder med stor diameter kræver høj strøm med deraf følgende høj varmedannelse under svejsningen.

Beklædningstype	Egenskaber	Brug
Rutil	Let at anvende	Alle positioner
Sur	Høj smeltehastighed	Flade
Basisk	Høj kvalitet i sammenføjningen	Alle positioner

Valg af svejsestrømmen

Svejsestrømsområdet for den anvendte elektrodetype vil være specificeret på elektrodeemballagen af fabrikanten.

Tænding og opretholdelse af lysbuen

Den elektriske lysbue tændes ved at gnide elektrodens spids mod svejseemnet, der er forbundet til jordkablet og - når lysbuen er tændt - ved hurtigt at trække stangen tilbage til den normale svejseafstand.

Det vil normalt være nyttigt at have en højere indledende strøm i forhold til basis-svejsestrømmen (Hot Start) for at lette tændingen af lysbuen. Når den elektriske lysbue er dannet, påbegyndes smeltningen af den midterste del af elektroden, der aflægges i dråbeform på svejseemnet. Elektrodens eksterne beklædning leverer under brugen beskyttelsesgas til svejsningen, der således vil være af god kvalitet. For at undgå at dråber af smeltet materiale ved kortslutning af elektroden med svejsebadet medfører slukning af lysbuen p.g.a. en utilsigtet tilnærmelse af de to enheder, vil det være hensigtsmæssigt at øge svejsestrømmen forbigående, indtil kortslutningen er afsluttet (Arc Force). Hvis elektroden hænger fast i svejseemnet, vil det være hensigtsmæssigt at sænke kortslutningsstrømmen til minimum (antisticking).

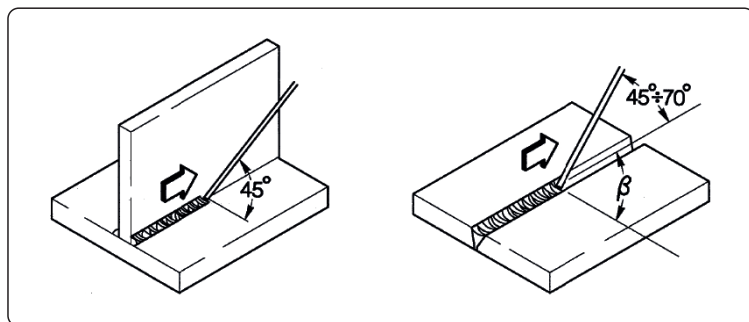

Udførelse af svejsningen

Elektrodens hældningsvinkel varierer afhængigt af antallet af afsættelser. Elektrodebevægelsen udføres normalt med svingninger og stop i siden af sømmen, således at man undgår for stor afsættelse af svejsemateriale i midten.

Fjernelse af slaggrer

Svejsning med beklædte elektroder kræver fjernelse af slaggrer efter hver svejseøm. Slaggrerne kan fjernes ved hjælp af en lille hammer eller ved børstning, hvis det drejer sig om skøre slaggrer.

9.2 TIG-svejsning (kontinuerlig lysbue)

Beskrivelse

TIG-svejsemetoden (Tungsten Inert Gas) er baseret på princippet med en elektrisk lysbue, der tændes mellem en ikke smeltbar elektrode (ren eller legeret tungsten med smeltetemperatur på cirka 3370°C) og svejseemnet. En atmosfære af inaktiv gas (argon) sørger for beskyttelse af badet. Derfor er svejsegeneratoren normalt udstyret med en anordning til tænding af lysbuen, der giver en høj frekvens og en høj spændingsudladning mellem spidsen af elektroden og svejseemnet. Takket være den elektriske gnist, der ioniserer gasatmosfæren, kan lysbuen derfor tændes uden nogen kontakt mellem elektroden og svejseemnet. Der findes også en starttype med reduceret tungstentilføjelse: start med lift, der ikke kræver høj frekvens, men kun en indledende tilstand med kortslutning ved lav strøm mellem elektroden og emnet. I det øjeblik, hvor elektroden løftes, skabes lysbuen, og strømmen øges, indtil den når den indstillede svejseværdi. For at forbedre kvaliteten af svejsevulstens afsluttende del er det hensigtsmæssigt at kunne betjene svejsestrømsænkningen med præcision, og det er nødvendigt, at gassen strømmer ned i svejsebadet endnu et par sekunder, efter at buen er gået ud. Under mange arbejdsforhold er det hensigtsmæssigt at kunne råde over to forindstillede svejsestrømme og med lethed at kunne skifte fra den ene til den anden (BILEVEL).

Svejsespolaritet

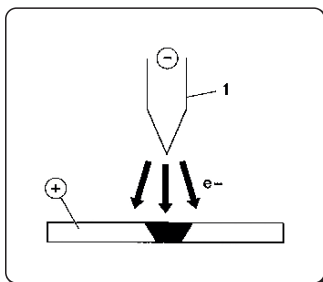

D.C.S.P. (Direct Current Straight Polarity)

Dette er den mest anvendte polaritet (direkte polaritet), der giver begrænset slid på elektroden (1), fordi 70 % af varmen koncentrerer på anoden (emnet).

Der fås smalle og dybe bade med høje fremføringshastigheder og lav varmetilførsel.

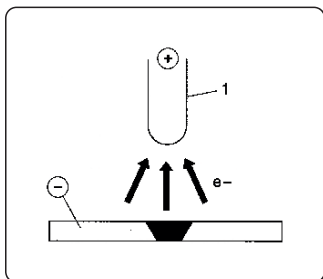

D.C.R.P. (Direct Current Reverse Polarity)

Omvendt polaritet bruges til svejsning af legeringer beklædt med et varmebestandigt oxydlag med en smeltetemperatur, der er højere end ved metal.

Der kan ikke anvendes høj strøm, fordi det vil medføre stort slid på elektroden.

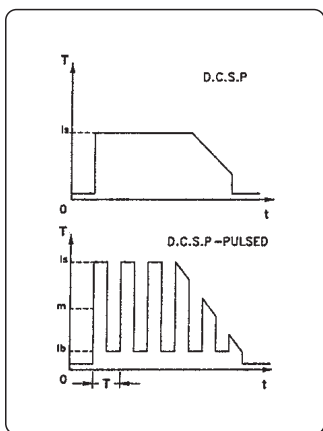

D.C.S.P.-Pulseret (Direct Current Straight Polarity Pulsed)

Når der anvendes en vedblivende pulseret strøm, opnås en bedre kontrol af svejsesbadets bredde og dybde under specielle arbejdsforhold.

Svejsesbadet formes af spidsimpulserne (I_p), hvorimod basisstrømmen (I_b) holder buen tændt. På denne måde bliver det nemmere at svejse tynde plader med mindre deformation, og der opnås en bedre formfaktor og dermed mindre fare for revner og gasgennemtrængninger.

Når frekvensen forøges (middelfrekvens) opnås en smalle, mere koncentreret og mere stabil bue samt en højere svejskvalitet ved tynde plader.

TIG-svejsning af stål

Tig-proceduren er meget effektiv ved svejsning af stål - både kulstål og legeringer - og ved første afsættelse på rør, samt ved svejsning, der kræver et optimalt udseende. Der kræves direkte polaritet (D.C.S.P.).

Forberedelse af kanterne

Proceduren kræver omhyggelig rengøring og forberedelse af kanterne.

Valg og forberedelse af elektroden

Det anbefales at anvende thorium-tungstenelektroder (2 % thorium-rødfarvet) eller som alternativ, ceriums- eller lanthans-elektroder med de nedenstående diametre:

Ø elektrode	Strømområde
1.0 mm	15÷75 A
1.6 mm	60÷150 A
2.4 mm	130÷240 A

Elektroden skal tilspidses som vist på illustrationen.

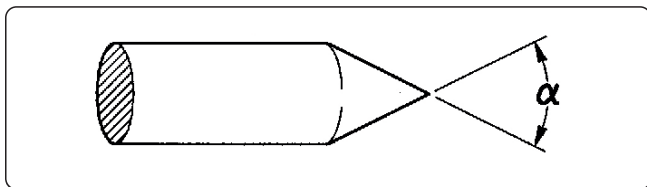

α°	Strømområde
30	0÷30 A
60÷90	30÷120 A
90÷120	120÷250 A

Svejestang

Svejestængerne skal have mekaniske egenskaber, der svarer til basismaterialets.

Undgå at bruge strimler fra basismaterialet, fordi de kan indeholde urenheder forårsaget af forarbejdningen, der kan få negativ indflydelse på svejsningen.

Beskyttelsesgas

Der anvendes i praksis altid ren argon (99,99 %).

DA

Svejestrøm	Ø elektrode	Gasdyse n°	Gasdyse	Argon flow
30 A	0÷30 mm	4/5	6/8.0 mm	5-6 l/min
60÷90 A	30÷120 mm	4/5/6	6.5/8.0/9.5 mm	6-7 l/min
90÷120 A	120÷250 mm	6/7	9.5/11.0 mm	7-8 l/min

TIG-svejsning af kobber

Fordi TIG-svejsning er en procedure med stor varmekoncentration, er den specielt egnet til svejsning af materialer med stor termisk ledsevne, som f.eks. kobber.

Ved TIG-svejsning af kobber skal man følge samme fremgangsmåde som ved TIG-svejsning af stål, eller specifikke vejledninger.

9.3 Svejsning med kontinuerlig tråd (MIG/MAG)

Indledning

Et MIG-system består af en jævnstrømskilde, en trådfremfører, en trådspole, en brænder og gas.

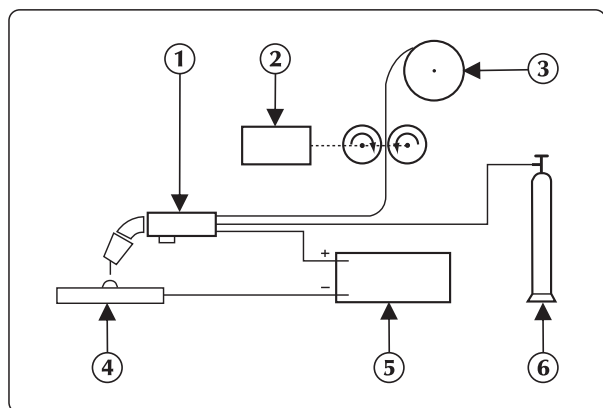

Anlæg til manuel svejsning

Strømmen overføres til lysbuen gennem smelte-elektroden (tråd anbragt med positiv polaritet);

Under denne proces overføres det smeltede metal til svejseemnet ved hjælp af lysbuen.

Den automatiske fremføring af den kontinuerlige elektrode af tilsatsmateriale (tråden) er nødvendig for at erstatte den smeltede svejsetråd under svejsningen.

Procedurer

Ved svejsning med gasbeskyttelse, danner den måde, hvorpå dråberne skilles fra elektroden, to forskellige overføringssystemer. Ved den første metode, der defineres som "KORTSLUTNINGS-OVERFØRSEL (SHORT-ARC)", dannes et lille, hurtigt-størknende bad, hvor metallet kun overføres fra elektroden til svejseemnet i en kort periode, mens elektroden er i kontakt med badet. I dette tidsrum, hvor elektroden er i direkte kontakt med badet, opstår der en kortslutning med en smelteeffekt for en del af tråden, der afbrydes, hvorefter lysbuen tændes igen, og cyklussen gentages.

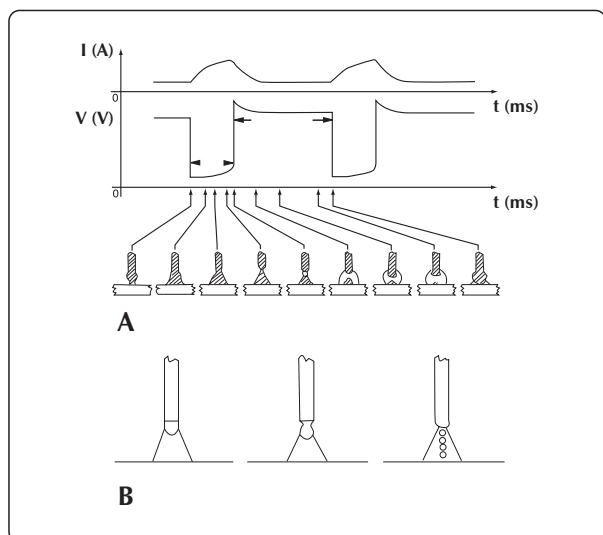

Cyklussen SHORT og svejsningen SPRAY ARC

Den anden metode for overførsel af dråberne er den såkaldte "SPRØJTE-OVERFØRSEL (SPRAY-ARC)", hvor metallet overføres i form af meget små dråber, der dannes og udskilles fra spidsen af tråden og overføres til badet via lysbuestrålen.

Vejseparametre



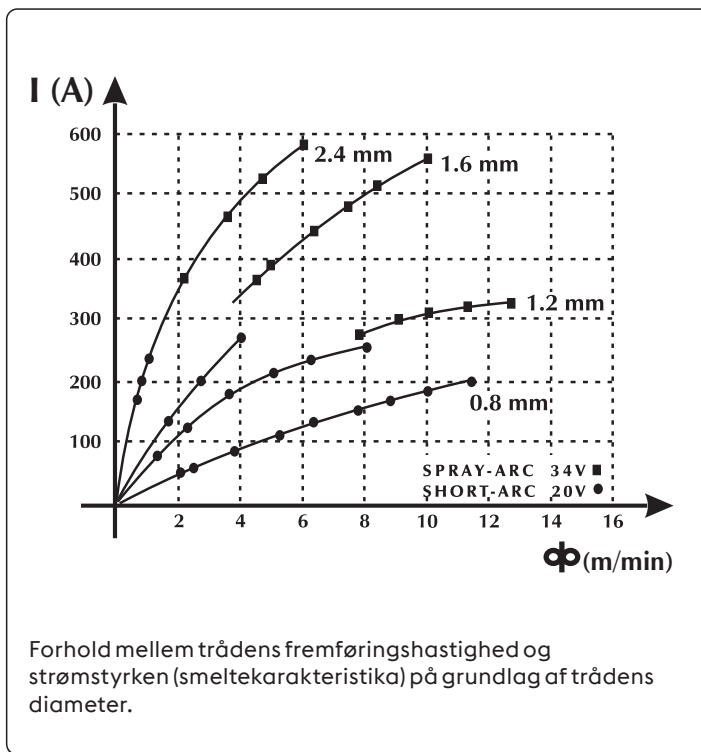
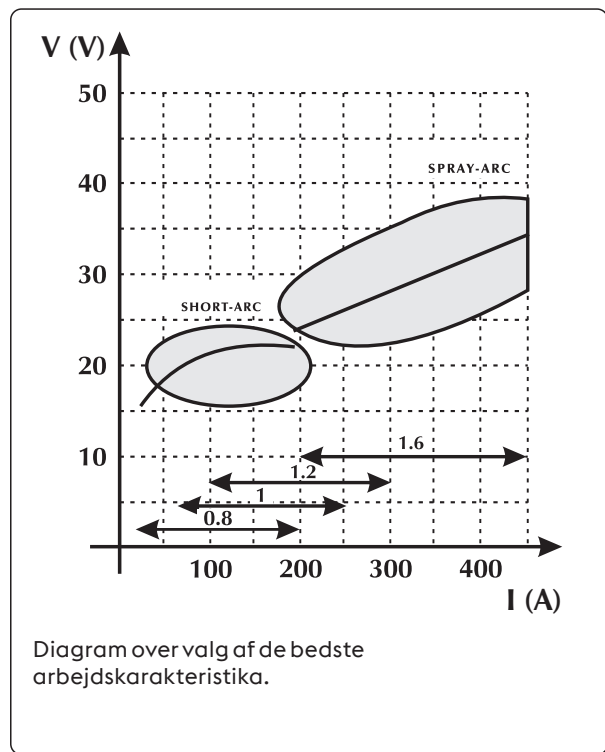

Lysbuens synlighed reducerer kravet om, at operatøren nøje skal holde øje med reguleringstabellerne, da han kan kontrollere smeltebadet direkte.

- Spændingen har direkte indflydelse på sømmens udseende, men svejssømmens mål kan varieres efter de forskellige behov ved manuelt at justere brænderens bevægelse, således at man opnår varierende aflægninger med konstant spænding.
- Trådens fremføringshastighed afhænger af svejsestrømmen.

Ниже на двух графиках показана взаимосвязь между различными параметрами сварки.

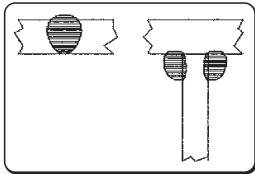
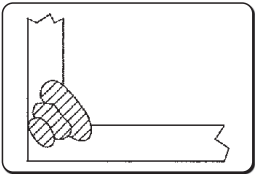
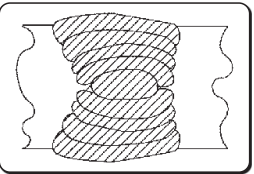

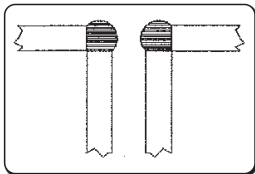
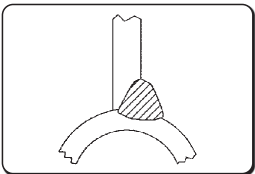
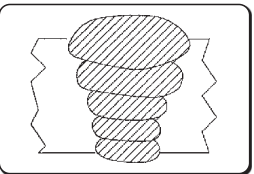
Vejledende tabel til valg af svejseparametrene i forhold til de mest almindelige arbejdsområder, samt de mest anvendte tråde

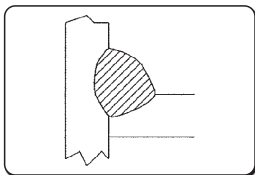
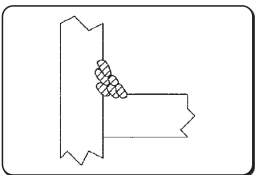
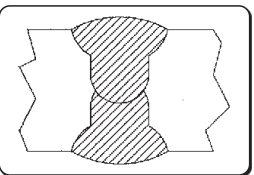
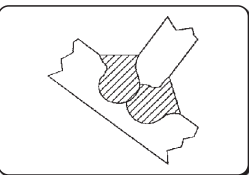
Lysbuespænding	Ø 0,8 mm	Ø 1,0-1,2 mm	Ø 1,6 mm	Ø 2,4 mm	
16V - 22V SHORT-ARC					
	60 - 160 A Lav gennemtrængning ved små tykkelser	100 - 175 A God kontrol af gennemtrængningen og smeltningen	120 - 180 A God smeltning vandret og lodret	150 - 200 A Ikke anvendt	
	24V - 28V SEMI SHORT-ARC (Overgangszone)				
		150 - 250 A Automatisk hjørnesvejsning	200 - 300 A Automatisk svejsning med høj spænding	250 - 350 A Automatisk svejsning (faldende)	300 - 400 A Ikke anvendt
30V - 45V SPRAY-ARC					
		150 - 250 A Lav gennemtrængning ved regulering til 200 A	200 - 350 A Automatisk svejsning med flere gennemførsler	300 - 500 A God gennemtrængning (faldende)	500 - 750 A God gennemtrængning og høj aflejring på store tykkelser

Anvendelige gasser

MIG-MAG-svejsning kendetegnes hovedsageligt af den anvendte gastype: inert til MIG-svejsning (Metal Inert Gas), aktiv til MAG-svejsning (Metal Active Gas).

- Kuldioxid (CO₂)

Ved anvendelse af CO₂ som beskyttelsesgas, opnår man høj gennemtrængning med stor fremføringshastighed, samt korrekte mekaniske egenskaber, samtidigt med en lav driftsomkostning. Alligevel medfører brug af denne gas store problemer vedrørende den afsluttende kemiske sammensætning af samlingerne, fordi der opstår tab af elementer, der har let ved at oxydere, og samtidigt tilføres der mere kulstof til badet. Svejsning med ren CO₂ giver også andre problemer, såsom for store mængder sprøjt, samt opståelse af porøsitet, forårsaget af kullite.

- Argon

Denne inaktive gas anvendes ren ved svejsning af letmetal-legeringer, hvorimod man til svejsning af rustfrit stål med kromnikkel bør foretrække at arbejde med tilføjelse af oxygen og CO₂ i procentdelen 2 %, fordi dette forhold bidrager til lysbues stabilitet og giver en forbedret form på svejsesømmen.

- Helium

Denne gas anvendes i stedet for argon, og giver større gennemtrængning (ved store tykkelser), samt større fremføringshastighed.

- Blanding af Argon og Helium

Ved denne blanding opnår man en mere stabil lysbue, samt større gennemtrængning og hastighed i forhold til argon.

- Blanding af Argon-CO₂ og Argon-CO₂-Oxygen

Disse blandinger anvendes til svejsning af jernholdige materialer, specielt under forhold med SHORT-ARC, fordi de forbedrer den specifikke varmetilførsel. Dette medfører dog ikke, at de ikke kan anvendes ved SPRAY-ARC.

Normalt indeholder blandingen en procentdel af CO₂ på mellem 8% og 20 % og O₂ på omtrent 5 %.

Se i anlæggets brugervejledning.

10. TEKNISKE SPECIFIKATIONER

Elektriske egenskaber			U.M.
Forsyningsspænding U1 (50/60 Hz)	3x230 (±15%)	3x400 (±15%)	Vac
Zmax (@PCC)*	62	62	mΩ
Forsinket linjesikring	30	20	A
Kommunikationstype	DIGITAL	DIGITAL	
Maks. effekt optaget	13.3	13.0	kVA
Maks. effekt optaget	12.8	12.4	kW
Absorberet effekt i inaktiv tilstand	71	71	W
Effektfaktor (PF)	0.96	0.95	
Ydeevne (μ)	85	85	%
Cos φ	0.99	0.99	
Maks. strøm optaget I1maks.	32.9	18.8	A
Effektiv strøm I1eff	20.8	13.3	A
Indstillingsområde (MMA)	3-320	3-320	A
Spænding uden belastning Uo	75	75	Vdc

* Dette udstyr opfylder EN / IEC 61000-3-11.

* Dette apparat overholder kravene ifølge normen EN / IEC 61000-3-12 hvis den største net-impedans tilladt ved grænsefladen med det offentlige net (fælles koblingspunkt - point of common coupling, pcc) er mindre end eller lig med den opgivne værdi "zmax". Såfremt udstyret skal tilsluttes et offentligt lavspændingsforsyningsnet, er det montørens eller brugerens ansvar at sikre, at udstyret kan tilsluttes; eventuelt ved henvendelse til elseskabet.

Brugsfaktor	3x230V	3x400V	U.M.
Brugsfaktor MMA (40°C)			
(X=35%)	320	-	A
(X=50%)	-	320	A
(X=60%)	270	300	A
(X=100%)	230	250	A
Brugsfaktor MMA (25°C)			
(X=60%)	320	320	A
(X=100%)	270	270	A
Brugsfaktor TIG (40°C)			
(X=45%)	320	-	A
(X=60%)	300	320	A
(X=100%)	250	270	A
Brugsfaktor TIG (25°C)			
(X=70%)	320	320	A
(X=100%)	270	270	A
Brugsfaktor MIG/MAG (40°C)			
(X=35%)	320	-	A
(X=50%)	-	320	A
(X=60%)	280	310	A
(X=100%)	230	250	A
Brugsfaktor MIG/MAG (25°C)			
(X=60%)	320	-	A
(X=70%)	-	320	A
(X=100%)	270	270	A

Fysiske egenskaber		U.M.
IP-beskyttelsesgrad	IP23S	
Isoleringsklasse	H	
Dimensioner (lxdxh)	620x240x460	mm
Vægt	26.7	Kg
Bygningsstandarder	EN IEC 60974-1/A1:2019 EN IEC 60974-3:2019 EN 60974-10/A1:2015	
Strømkabelsektion	4x4	mm ²
Længde af forsyningskabel	5	m

11. DATASKILT

VOESTALPINE BÖHLER WELDING SELCO S.R.L. Via Palladio, 19 - ONARA (PADOVA) - ITALY			
URANOS NX 3200 PME		N°	
EN IEC 60974-1/A1:2019 60974-10/A1:2015 Class A			
U ₀ 75V	3A/20.0V - 320A (320A)/32.8V (32.8V)		
	X (40°C)	50% (35%)	60%
U ₀ 75V	I ₂	320A (320A)	300A (270A)
	U ₂	32.8V (32.8V)	32.0V (30.8V)
U ₀ 75V	3A/10.0V - 320A (320A)/22.8V (22.8V)		
	X (40°C)	(45%)	60%
U ₀ 75V	I ₂	(320A)	320A (300A)
	U ₂	(22.8V)	22.8V (22.0V)
U ₀ 75V	3A/14.0V - 320A (320A)/30.0V (30.0V)		
	X (40°C)	50% (35%)	60%
U ₀ 75V	I ₂	320A (320A)	310A (280A)
	U ₂	30.0V (30.0V)	29.5V (28.5V)
U ₁ 400V(230V)	I _{1max} 18.8A(32.9A)	I _{1eff} 13.3A(20.8A)	
IP 23 S	UK CA CE EAC MADE IN ITALY		

12. BETYDNING AF OPLYSNINGERNE DATASKILT

1		2			
3		4			
5	6				
7	9	23			
		11			
8	10	12	15	16	17
		13	15A	16A	17A
7	9	11			
		11			
8	10	12	15	16	17
		13	15A	16A	17A
7	9	11			
		11			
8	10	12	15	16	17
		13	15A	16A	17A
18	19	20	21		
22	UK CA CE EAC MADE IN ITALY				

- 1 Fremstillingsmærke
- 2 Navn og adresse på producenten
- 3 Apparatets model
- 4 Serienummer
X**XX**XXXXXXXXXX Produktionsår
- 5 Symbol for typen af svejseapparat
- 6 Henvisning til konstruktionsstandarder
- 7 Symbol for svejseprocessen
- 8 Symbol for svejsemaskiner egnet til arbejde i et miljø med øget risiko for elektrisk stød
- 9 Symbol for svejsestrøm
- 10 Nominel spænding i tomgang
- 11 Område for maksimal og minimum nominel svejsestrøm og den tilsvarende konventionelle belastningsspænding
- 12 Symbol for intermitterende cyklus
- 13 Symbol for nominel svejsestrøm
- 14 Symbol for nominel svejsestrøm
- 15 Værdier for intermitterende cyklus
- 16 Værdier for intermitterende cyklus
- 17 Værdier for intermitterende cyklus
- 15A Værdier for nominel svejsestrøm
- 16A Værdier for nominel svejsestrøm
- 17A Værdier for nominel svejsestrøm
- 15B Værdier for konventionel belastningsspænding
- 16B Værdier for konventionel belastningsspænding
- 17B Værdier for konventionel belastningsspænding
- 18 Symbol for strømforsyning
- 19 Nominel forsyningspænding
- 20 Maksimal nominel strømforsyningsstrøm
- 21 Maksimal faktisk strømforsyningsstrøm
- 22 Beskyttelsesgrad
- 23 Nominel spidsspænding

CE EU-overensstemmelseserklæring
 EAC EAC-overensstemmelseserklæring
 UKCA UKCA-overensstemmelseserklæring

DA

INNHOLDSFORTEGNELSE

1. ADVARSEL	421
1.1 Bruksmiljø.....	421
1.2 Personlig beskyttelse og beskyttelse av tredje mann	421
1.3 Beskyttelse mot røyk og gass	422
1.4 For å forebygge brann/eksplosjoner.....	422
1.5 Forebyggelse ved bruk av gassbeholder	423
1.6 Vern mot elektrisk støt.....	423
1.7 Elektromagnetiske felt og forstyrrelser	423
1.8 Vernegrad IP	424
1.9 Avhending	424
2. INSTALLASJON.....	424
2.1 Løfting, transport og lossing.....	425
2.2 Plassering av anlegget	425
2.3 Kopling.....	425
2.4 Installasjon.....	425
3. PRESENTASJON AV ANLEGGET	428
3.1 Bakpanel.....	428
3.2 Støpselpanel	428
3.3 Frontpanel med kontroller	428
3.4 Frontpanel med kontroller	429
4. BRUK AV UTSTYRET.....	430
4.1 Startskjerm.....	430
4.2 Testskjerm.....	430
4.3 Hovedskjerm.....	430
4.4 Hovedskjerm bilde MMA-prosess.....	431
5. INNSTILLING.....	438
5.1 Oppsett og innstillinger av parametrene	438
5.2 Spesifikke prosedyrer for bruk av parametrene.....	447
6. VEDLIKEHOLD.....	451
6.1 Utfør følgende periodiske inngrep på generatoren.....	452
6.2 Sorumluluk	452
7. ALARM KODER	452
8. DIAGNOSTIKK OG LØSNINGER.....	454
9. TEORETISKE BESKRIVELSER AV SVEISING	458
9.1 Sveising med bekledd elektrode (MMA)	458
9.2 TIG-Sveising (kontinuerlig bue).....	458
9.3 Kontinuerlig trådsveising (MIG/MAG)	460
10. TEKNISK SPESIFIKASJON.....	463
11. IDENTIFIKASJONSPLATE.....	464
12. BESKRIVELSE INFORMASJONSSKILT.....	464
13. SKJEMA.....	557
14. SKJØTEMUNNSTYKKER.....	559
15. LISTE OVER RESERVEDELER.....	560

SYMBOLENES FORKLARING



Store farer som forårsaker alvorlige skader på personer og farlig oppførsel som kan føre til alvorlige skader.



Viktig råd for å unngå mindre skader på personer eller gjenstander.



Tekniske merknader for å lette operasjonene.

1. ADVARSEL



Før du begynner operasjonene, må du forsikre deg om å ha lest og forstått denne håndboka.

Utfør ikke modifiseringer eller vedlikeholdsarbeid som ikke er beskrevet. Produsenten er ikke ansvarlig for skader på personer eller ting som oppstår på grunn av mangelfull forståelse eller manglende utførelse av instruksjonene i denne håndboka.

Vienmēr glabājiet lietošanas instrukciju aparāta izmantošanas vietā. Papildus lietošanas instrukcijai, ievērojiet arī vispārējos noteikumus un vietējos spēkā esošos noteikumus par negadījumu novēršanu un vides aizsardzību.



Visām personām, kuras iesaistītas aparāta ievadē ekspluatācijā, lietošanā, apkopē un remontā, ir:

- jābūt piemērotai kvalifikācijai;
- jābūt nepieciešamām prasmēm metināšanas jomā;
- pilnībā jāizlasa un rūpīgi jāievēro šī lietošanas instrukcija.

Ved tvil og problemer om bruken av anlegget, skal du henvende deg til kvalifisert personell.

1.1 Bruksmiljø



Alt utstyr skal kun brukes for operasjoner som det er prosjektert til, på den måte og i områdene som er angitt på skiltet og/eller i denne håndboka, i samsvar med nasjonale og internasjonale direktiver om sikkerhet. Bruk som skiller seg fra bruksmønster angitt av fabrikanten er ikke egnet og kan være farlig; i et slikt tilfelle frasier fabrikanten seg alt ansvar.



Denne enheten må brukes kun i profesjonelle applikasjoner i industrimiljøer. Fabrikanten er ikke ansvarlig for skader som er forårsaket ved privat bruk av anlegget.



Anlegget skal brukes i miljøer med en temperatur mellom -10°C og +40°C (mellom +14°F og +104°F).

Anlegget skal transporteres og oppbevares i miljøer med en temperatur mellom -25°C og +55°C (mellom -13°F og 131°F).

Anlegget skal brukes i miljøer fritt for støv, syre, gass eller andre etsende stoffer.

Anlegget må ikke brukes i miljøer med en luftfuktighet over 50% ved 40°C (104°F).

Anlegget må ikke brukes i miljøer med en luftfuktighet over 90% ved 20°C (68°F).

Anlegget må ikke brukes høyere enn 2000m over havet.



Ikke bruk denne typen apparat for å tine opp frosne rør.

Bruk aldri apparatet for å lade batterier og/eller akkumulatorer.

Bruk ikke apparatet for å starte motorer.

1.2 Personlig beskyttelse og beskyttelse av tredje mann



Sveiseprosedyren kan danne farlig stråling, støy, varme og gass. Installer et brannsikket skillerom for å beskytte sveisesonen fra stråler, gnister og glødende slag. Advar alle mennesker i nærheten at de ikke må feste blikket på sveisebuen eller på det glødende metallet, og få en brukbar beskyttelse.



Ha på deg verneklær for å beskytte huden fra strålene, gnistene eller på det glødende metallet, og få en tilfredsstillende beskyttelse. Du må ha på deg egnet klær som dekker hele kroppen og er:

- hele og i god stand
- ikke brannfarlige
- isolerende og tørre
- tettsittende og uten mansjetter og oppbrett



Bruk alltid foreskrevne sko som er sterk og er garantert vanntett.

Bruk alltid foreskrevne hansker som isolerer mot elektrisitet og varme.



Bruk masker med sidebeskyttelser for ansiktet og egnet beskyttelsesfilter (minst NR10 eller mere) for øyene dine.



Ha alltid på deg vernebriller med sideskjermer spesielt under manuelle eller mekanisk fjerning av sveiseslagg.



Bruk aldri kontaktlinser!



Bruk hørselvern hvis sveiseprosedyren forårsaker farlig støy. Hvis støynivået overstiger de tillatte grensene, må du avgrense arbeidssonen og forsikre deg om at personene som befinner seg i sonen er utstyrt med hørselvern.



Hold alltid sidepanelene lukket under sveiseprosedyren. Du skal ikke utføre endringer på anlegget.



Hold alltid sidepanelene lukket under sveiseprosedyren. Unngå kontakt mellom hender, hår, klær, utstyr... og bevegelige deler som: vifter, tannhjul, valser og spindler, trådspoler. Ikke berør tannhjul når trådtrekkeren er igang. Du skal ikke utføre endringer på anlegget. Utkopling av sikkerhetsutstyr på enhetene for fremtrekk av tråden er meget farlig og fritar fabrikanten for ethvert ansvar med hensyn til skader på utstyr eller personer.



Hold hodet borte fra Mig-/Mag-sveisebrenneren under lading og fremtrekk av tråden. Tråden som kommer ut kan føre til alvorlige skader på hendene, ansiktet og øyene.



Unngå å røre ved delene som du nettopp har sveiset, da den høye temperaturen kan føre til alvorlige forbrenninger eller skader. Følg alle forholdsregler som er beskrevet også i bearbeidelsene etter sveisingen, da stykkene som du sveiset kan gi fra seg slaggrester mens de avkjøles.



Forsikre deg om at sveisebrenneren er avkjølet før du utfører arbeid eller vedlikehold på den.



Forsikre deg om at kjøleaggregatet er slått av før du frakopler slanger for tilførsel og retur av kjølevæsken. Den varme væsken som kommer ut kan føre til alvorlige forbrenninger eller skålding.



Forsikre deg om at det finnes et førstehjelpskrin i nærheten. Ikke undervurder forbrenninger eller sår.



Før du forlater arbeidsplassen, skal du forsikre deg om at sonen er sikker for å forhindre ulykker som kan føre til skader på utstyr eller personer.

1.3 Beskyttelse mot røyk og gass



Røyk, gass og støv som dannes under sveisingen kan være farlige for helsen. Røyken som blir produsert under sveiseprosedyren kan føre til kreft eller fosterskade på kvinner som er gravide.

- Hold hodet borte fra sveisegass og sveiserøyk.
- Forsikre deg om at ventilasjonen er fullgod, naturlig eller luftkondisjonering, i arbeidssonen.
- Ved utilstrekkelig ventilasjon, skal du bruke ansiktsmaske med luftfilter.
- Ved sveising i trange miljøer, anbefaler vi deg å ha oppsyn med operatøren ved hjelp av en kollega som befinner seg ute.
- Bruk aldri oksygen for ventilasjon.
- Kontroller oppsugets effektivitet ved regelmessig å kontrollere mengden av skadelig gass som blir fjernet i forhold til verdiene fastsatt i sikkerhetsnormene.
- Mengden og farlighetsgraden av røyken som blir generert beror på basismaterialet som blir brukt, støttematerialet og alle eventuelle stoffer som er brukt for rengjøring og fjerning av fett fra stykkene som skal sveises. Følg nøye instruksene fra fabrikanten og tilhørende tekniske spesifikasjoner.
- Utfør ikke sveiseprosedyren i nærheten av plasser hvor avfetting eller maling skjer.
- Plasser gassbeholdere utendørs eller på en plass med god luftsirkulasjon.

1.4 For å forebygge brann/eksplosjoner



Sveiseprosedyren kan forårsake brann og/eller eksplosjoner.

- Fjern alle brannfarlige eller lettantennlige materialer eller gjenstander fra arbeidssonen.
- Brannfarlige stoffer må være på minst 11 meters avstand fra sveisemiljøet og beskyttes på egnet måte.
- Gnistsprut og glødende partikler kan lett nå sonene rundt enheten også gjennom små åpninger. Vær spesielt forsiktig med å beskytte gjenstander og personer.
- Utfør ikke sveisingen på eller i nærheten av trykkbeholdere.
- Utfør ikke sveiseoperasjoner på lukkede beholdere eller rør. Vær meget forsiktig ved sveising av rør eller beholdere selv om de er åpen, tømt og rengjort med stor omhu. Rester av gass, drivstoff, olje eller lignende kan føre til eksplosjon.
- Du skal ikke sveise i miljøer hvor det er støv, gass eller eksplosiv damp.
- Etter sveisingen skal du forsikre deg om at kretsen under spenning ikke kan komme bort i delene som er koplet til jordledningskretsen.
- Plasser et brannslukningsapparat i nærheten av maskinen.

1.5 Forebyggelse ved bruk av gassbeholder



Inerte gassbeholdere inneholder gass under trykk og kan eksplodere hvis du ikke sikrer forholdene for transport, vedlikehold og bruk.

- Gassbeholderne skal være festet vertikalt ved veggen eller andre støtteinnretninger for å unngå fall og plutselige mekaniske støt.
- Stram vernehetten på ventilen under transport, oppstart og hver gang du avslutter sveiseprosedyren.
- Unngå å utsette beholderne direkte for solstråler, plutselige temperaturforandringer, for høye eller ekstreme temperaturer. Utsett ikke gassbeholderne for altfor høye eller lave temperaturer.
- Hold beholderne vekk fra flammer, elektriske buer, sveisebrennere eller elektrodeholdetenger og glødende deler som fremkommer under sveiseprosedyren.
- Hold beholderne borte fra sveisekretsene og strømkretsene generelt.
- Hold hodet borte fra gassutslippet når du åpner beholderens ventil.
- Lukk alltid beholderens ventil når du avslutter sveiseprosedyrene.
- Utfør aldri sveising på en gassbeholder under trykk.
- Kople aldri en trykklftsbeholder direkte til maskinens reduksjonsventil! Trykket kan overstige reduksjonsventilens kapasitet og eksplodere!

1.6 Vern mot elektrisk støt



Et elektrisk støt kan være dødelig.

- Unngå å røre ved innvendige eller utvendige deler som er forsynt med strøm i sveise mens anlegget er slått på (sveisebrenner, tenger, jordledninger, elektroder, ledninger, ruller og spoler er elektrisk koplet til sveisekretsen).
- Forsikre deg om at anleggets og operatørens elektriske isolering er korrekt ved å bruke tørre steder og gulv som skal være tilstrekkelig isolert fra jord.
- Forsikre deg om at anlegget er korrekt koplet til uttaket og at nettet er utstyrt med en jordforbindelse.
- Berør aldri samtidig to sveisebrennere eller to elektrodeholdertenger.
- Avbryt umiddelbart sveiseprosedyren hvis du føler elektriske støt.

1.7 Elektromagnetiske felt og forstyrrelser



Strømmen gjennom de innvendige og utvendige kablene i anlegget danner elektromagnetiske felt i nærheten av sveisekablene og anlegget.

- De elektromagnetiske feltene kan ha innvirkning på helsen til operatører som er utsatt for feltene under lange perioder (nøyaktig påvirkning er idag ukjent).
- De elektromagnetiske feltene kan påvirke andre apparater som pacemaker eller høreapparater.



Alle personer som har livsviktige elektroniske apparater (pace-maker) må henvende seg til legen før de nærmer seg soner hvor sveiseoperasjonene.

1.7.1 EMC overensstemmelse med: EN 60974-10/A1:2015.

Klasse
B

Utstyr klasse B er i overensstemmelse med elektromagnetiske kompatibilitetskrav i industriell og beboelsesmiljø, inkludert boligområder hvor den elektriske kraft er forsynt fra det offentlige lavspennings forsyningssystem.

Klasse
A

Utstyr klasse A er ikke ment for bruk i boligområder hvor den elektriske kraft er forsynt fra det offentlige lavspennings forsyningssystem. Det kan være potensielle vanskeligheter i å sikre elektromagnetisk kompatibilitet av utstyr klasse A i disse områder, på grunn av styrte såvel som utstrålte forstyrrelser.

For mer informasjon, se kapitlet: DATASKILT eller TEKNISK SPESIFIKASJON.

1.7.2 Installasjon, bruk og vurdering av området

Dette apparatet er konstruert i samsvar med kravene i den harmoniserte normen EN 60974-10/A1:2015 og er identifisert som "KLASSE A". Denne enheten må brukes kun i profesjonelle applikasjoner i industrimiljøer. Fabrikanten er ikke ansvarlig for skader som er forårsaket ved privat bruk av anlegget.



Brukeren må ha erfaringer i sektoren og er ansvarlig for installasjonen og bruken av enheten i overensstemmelse med fabrikantens anvisninger. Hvis elektromagnetiske forstyrrelser oppstår, er det brukeren som må løse problemet, om nødvendig ved hjelp av fabrikantens tekniske assistanse.



Uansett må de elektromagnetiske forstyrrelsene bli redusert slik at de ikke utgjør et problem.



Før du installerer denne enheten, må du ta i betraktning mulige elektromagnetiske problemer som kan oppstå i området og som kan være farlige for personene som er området, f.eks. personer som bruker pace-maker eller høreapparater.

1.7.3 Krav hovedforsyning

Høyeffektutstyr kan, på grunn av primærstrøm trukket fra hovedforsyningen, influere på kraftkvaliteten på nettet. Derfor, tilkoplingsrestriksjoner eller krav angående maksimum tillatt impedanse på nettet (Z_{max}) eller den nødvendige minimum forsyningskapasitet (S_{sc}) på grensesnittspunktet til det offentlige nett (punkt for felles sammenkopling, PCC), kan bli brukt for enkelte typer utstyr (se tekniske data). I slike tilfeller er ansvaret hos installatør eller bruker av utstyret for å forsikre seg om, ved å konsultere operatøren av forsyningsnettverket om nødvendig, at utstyret kan tilkoples. I tilfelle av forstyrrelser, kan det være nødvendig å utføre andre operasjoner, som f.eks. filtrering av strømforsyningen fra elnettet.

Du må også kontrollere muligheten av å skjerme nettkabelen.

For mer informasjon, se kapittelet: TEKNISK SPESIFIKASJON.

1.7.4 Forholdsregler for kabler

For å minke effektene av elektromagnetiske felt, skal du følge disse reglene:

- Hvis mulig skal du bunte sammen jordledningen og nettkabelen.
- Aldri tvinn kablene rundt kroppen.
- Unngå å stille deg mellom jordledningen og nettkabelen (hold begge kablene på samme side).
- Kablene skal være så korte som mulig, og plasseres så nær hverandre som mulig og lagt på eller omtrentlig på gulvnivået.
- Plasser anlegget på noe avstand fra sveiseområdet.
- Kablene plasseres på avstand fra eventuelle andre kabler.

1.7.5 Jording

Jording av alle metallkomponenter i sveiseanlegget og dens miljø må tas i betraktning. Følg nasjonale og lokale forskrifter for jording.

1.7.6 Jording av delen som skal bearbeides

Hvis delen som skal bearbeides ikke er jordet av elektriske sikkerhetsgrunner eller på grunn av dens dimensjoner og plassering, kan du bruke en jordledning mellom selve delen og jordkontakten for å minke forstyrrelsene. Vær meget nøye med å kontrollere at jordingen av delen som skal bearbeides ikke øker risikoen for ulykker for brukerne eller risikoen for skader på andre elektriske apparater. Følg gjeldende nasjonale og lokale forskrifter for jording.

1.7.7 Skjerming

Skjerming av andre kabler og apparater i nærheten kan redusere problemet med forstyrrelser.

Skjerming av hele sveiseanlegget kan være nødvendig for spesielle applikasjoner.

1.8 Vernegrad IP



IP23S

- Innhold som er beskyttet mot tilgang til farlige deler med fingrene og innføring av massive fremmedlegemer med en diameter som overstiger/er lik 12,5 mm.
- Innholdet er beskyttet mot regn i en skråvinkel på 60°.
- Innholdet er beskyttet mot skadelige effekter grunnet inntrenging av vann, når apparatets bevegelige deler ikke er igang.

1.9 Avhending



Ikke sluttbehandle apparatet som usortert kommunalt avfall!

I samsvar med EU-direktiv 2012/19/EU om avfall fra elektrisk og elektronisk utstyr og implementering av direktivet i samsvar med nasjonal lovgivning, skal elektrisk utstyr ved levetidens utløp innsamles separat og leveres inn til et innsamlingsssenter. Eierne av utstyret må kontakte de lokale myndighetene for informasjon om nærmeste innsamlingsssenter. Anvendelsen av EU-direktivet vil forbedre miljøet og menneskehelsen.

2. INSTALLASJON



Installasjonen kan kun utføres av profesjonelt personale som er autorisert av fabrikanten.



Under installasjonen, skal du forsikre deg om at generatoren er frakoplet.



Det er forbudt å kople sammen (serie eller parallelt) generatorene.

2.1 Løfting, transport og lossing

- Anlegget er utstyrt med et håndtak som muliggjør manuell transportering.
- Anlegget er ikke utstyrt med spesifikke deler for løfting.
- Bruk en gaffeltruck og vær meget forsiktig ved bevegelsene for å unngå at generatoren faller i bakken.



- Ikke undervurder anleggets vekt, (se teknisk spesifikasjon).
- Ikke la lasten bevegges eller henges over personer eller ting.
- Ikke dropp eller belaste anlegget med unødvendig tyngde.

2.2 Plassering av anlegget



Følg disse reglene:

- Gi lett adgang til kontrollene og kontaktene.
- Plasser ikke utstyret i trange rom.
- Sett aldri anlegget på en flate med en skråning som overstiger 100 fall.
- Plasser anlegget på en tørr og ren plass med tilstrekkelig ventilasjon.
- Beskytt anlegget mot regn og sol.

2.3 Kopling



Strømforsyningen er utstyrt med en nettkabel som skal koples til nettet.

Anlegget kan forsynes som følger:

- 400V trefase
- 230V trefase

Apparatets funksjon er garantert for spenninger som skiller seg maks. $\pm 15\%$ fra nominell verdi (med V_{nom} 400V, vil arbeidsspenningen være mellom 320V og 440V).



For å unngå skader på personer eller på anlegget, skal du kontrollere den nettspenning som er valgt, og sikringene, FØR du kople maskinen til nettet. Dessuten skal du forsikre deg om at kabelen blir koplet til et uttak med jordkontakt.



Det er mulig å forsyne anlegget ved hjelp av et aggregat, hvis denne garanterer en stabil strømforsyning $\pm 15\%$ i forhold til nominell spenningsverdi som er angitt av fabrikanten i alle mulige bruksforhold og med maksimal effekt som gis fra generatoren. I alminnelighet anbefaler vi bruk av aggregat med en effekt tilsvarende 2 ganger generatorens effekt hvis du bruker et enfasesystem eller 1,5 ganger effekten hvis du bruker et trefasesystem. Vi anbefaler deg å bruke aggregater med elektronisk kontroll.



For beskyttelse av brukeren, skal anlegget være korrekt koplet til jord. Nettkabelen er utstyrt med en ledning (gul/grønn) for jordledning og den skal koples til en kontakt utstyrt med jordforbindelse. Denne gul/grønne kabel må ALDRI brukes sammen med andre ledere for spenningskoplinger. Sjekk at anlegget er jordet og at stikkkontakten er i god stand. Bruk bare typegodkjente støpsler i samsvar med sikkerhetsforskriftene.



El-anlegget må settes opp av teknisk kyndig personale, hvis tekniske arbeidskunnskaper er spesifikke og i samsvar med lovgivningen i det landet der installasjonen utføres.

2.4 Installasjon

2.4.1 Tilkobling for MMA-sveising



Tilkoblingen utført som i illustrasjonen gir som resultat sveising med omvendt polaritet. For å kunne sveise med direkte polaritet må man koble om.

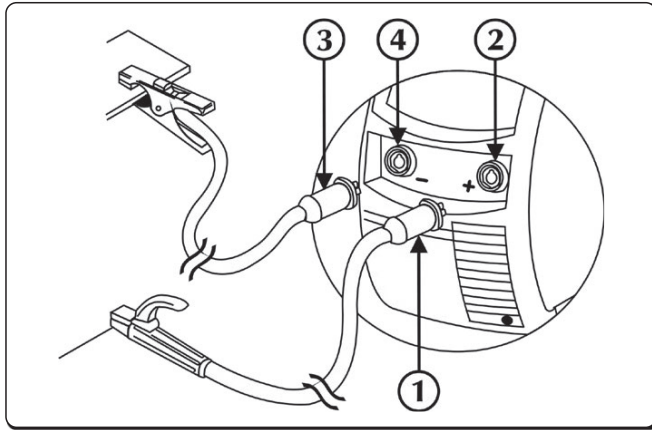

- ① Jordklemmekontakt
- ② Negativt strømuttak (-)
- ③ Kontakt for elektrodeholderklemme
- ④ Positivt strømuttak (+)

- ▶ Kopl jordklemmen til den negative sokkelen (-) på strømkilden. Sett inn kontakten og dreii den med klokken til delene er helt sikret.
- ▶ Kopl elektrodeholderen til den positive sokkelen (+) på strømkilden. Sett inn kontakten og dreii den med klokken til delene er helt sikret.

2.4.2 Tilkobling for TIG-sveising

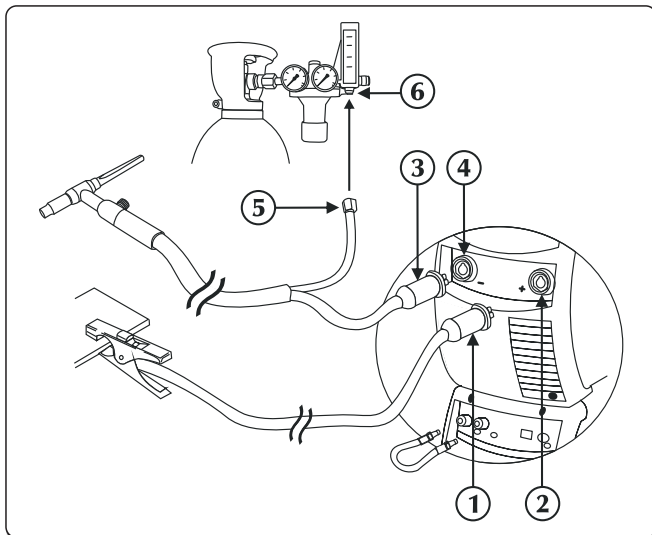

- ① Jordklemmekontakt
- ② Positivt strømuttak (+)
- ③ TIG brennerens feste
- ④ Fakkeltikkontakt
- ⑤ Kobling for gassrør
- ⑥ Reduksjonsventilen

- ▶ Kopl jordklemmen til den positive sokkelen (+) på strømkilden. Sett inn kontakten og dreii den med klokken til delene er helt sikret.
- ▶ Kopl TIG brennerkopling til brennersokkelen på strømkilden. Sett inn kontakten og dreii den med klokken til delene er helt sikret.



Reguleringen av flyten av dekkgassen skjer ved å dreie på en kran som normalt finnes på brenneren.

- ▶ Koble brennerens gasslange separat til selve gass fordelingen.
- ▶ Koble vannslangen fra sveisebrenneren (rød farge) til hurtigkoplings (rød farge) inntak på kjøleenheten.
- ▶ Koble vannslangen fra sveisebrenneren (blå farge) til hurtigkoplings (blå farge) uttak på kjøleenheten.

2.4.3 Kopling for MIG/MAG-sveising

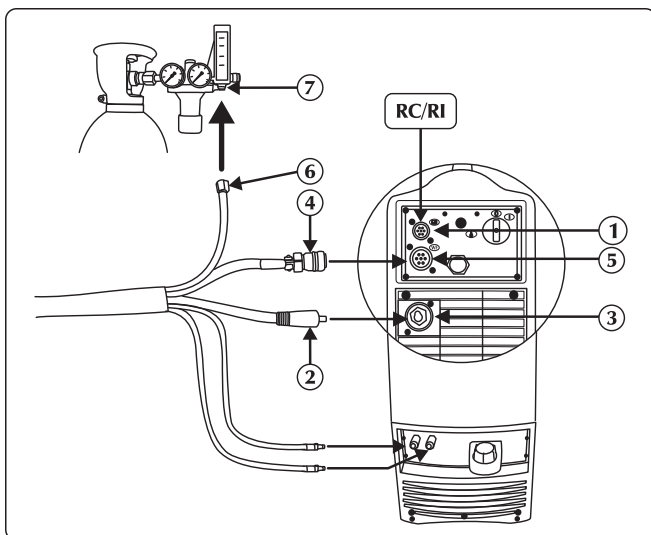

- ① Signalkabel (CAN-BUS) inngang
- ② Strømkabelen
- ③ Positivt strømuttak (+)
- ④ Signalkabel
- ⑤ Inngang signalkabel (CAN-BUS) (Kabelbunt)
- ⑥ Gassrør
- ⑦ Koblingsstykke gassforsyning

- ▶ Kople strømkabelen til korrekt uttak. Sett inn kontakten og dreii den med klokken til delene er helt sikret.
- ▶ Kople signalkabelen til korrekt kontakt. Sett i konnektoren og dreii ringmutteren medurs til delen er skikkelig fast.
- ▶ Kople gasslangen til beholderens trykkreduksjonsventil eller til gassforsyningen. Reguler gassflyten mellom 10 til 30 l/min.
- ▶ Kople vannslangen (blå farge) til hurtigkoplingsuttaket (blå farge ) på kjøleenheten.
- ▶ Kople vannslangen (rød farge) til hurtigkoplings (rød farge ) inntak på kjøleenheten.

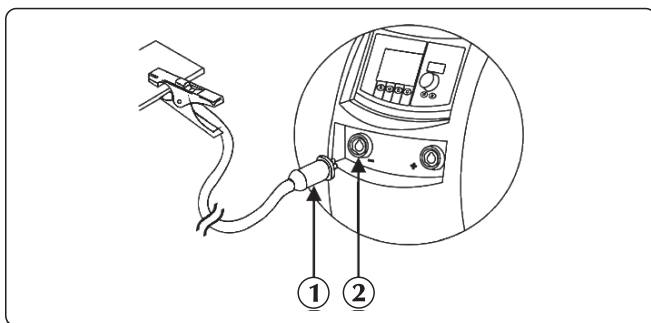

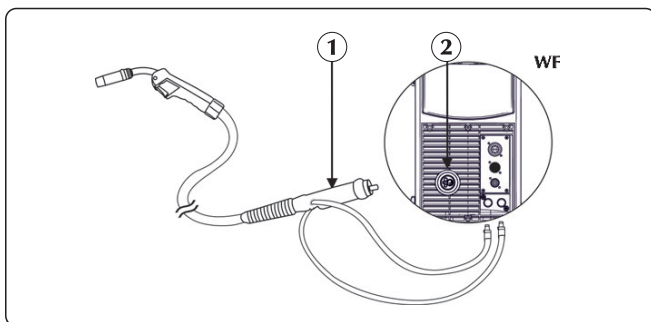

- ① Jordklemmekontakt
- ② Negativt strømuttak (-)

- ▶ Kopl jordklemmen til den negative sokkelen (-) på strømkilden. Sett inn kontakten og dreii den med klokken til delene er helt sikret.



- ① Sveisebrennerens feste
- ② Kontakt

- ▶ Kople vannslangen fra sveisebrenneren (blå farge) til hurtigkoplings (blå farge ) uttak på kjøleenheten.
- ▶ Kople vannslangen fra sveisebrenneren (rød farge) til hurtigkoplings (rød farge ) inntak på kjøleenheten.
- ▶ Kople MIG/MAG-brenneren til sentraladapteren, og vær meget nøye med å skru festeringen helt fast.

3. PRESENTASJON AV ANLEGGET

3.1 Bakpanel

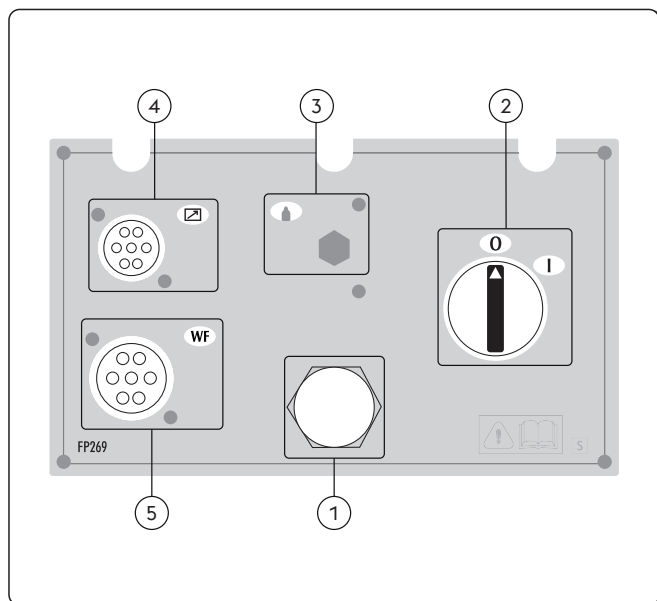

- ① **Strømforsyningskabel**
For å forsyne anlegget med strøm ved kopling til nettet.
- ② **Av/PÅ-bryter**
Styrer den elektriske påslåingen av sveisemaskinen. Den har to posisjoner "O" slått av; "I" slått på.
- ③ **Ikke brukt**
- ④ **Signalkabel CAN-BUS inngang (RC, RI...)**
- ⑤ **Inngang signalkabel (CAN-BUS) (Kabelbunt)**

3.2 Støpselpanel

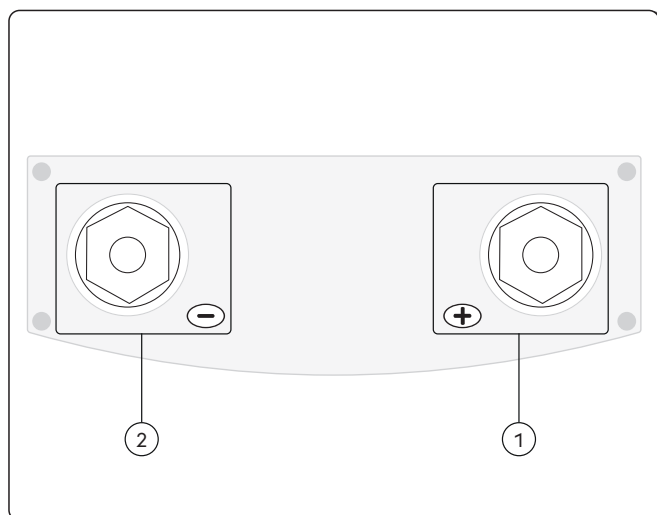

- ① **Positivt strømuttak (+)**
Prosess MMA: Tilkobling elektrodelommelykt
Prosess TIG: Tilkobling jordkabel
- ② **Negativt strømuttak (-)**
Prosess MMA: Tilkobling jordkabel
Prosess TIG: Tilkobling lommelykt
MIG/MAG-prosess: Tilkobling jordkabel



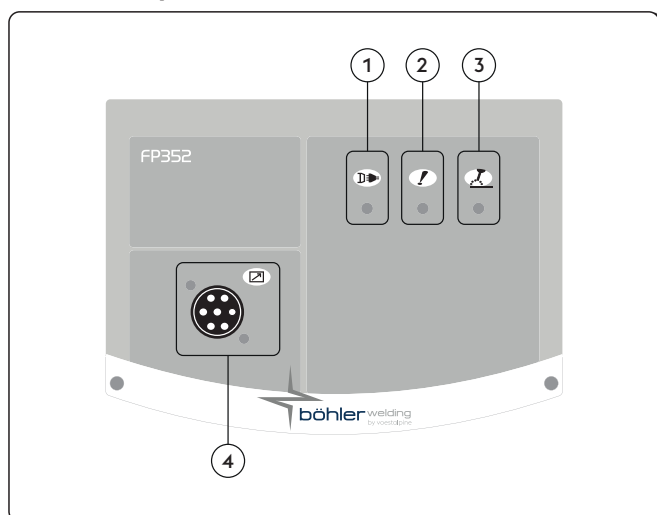



3.3 Frontpanel med kontroller

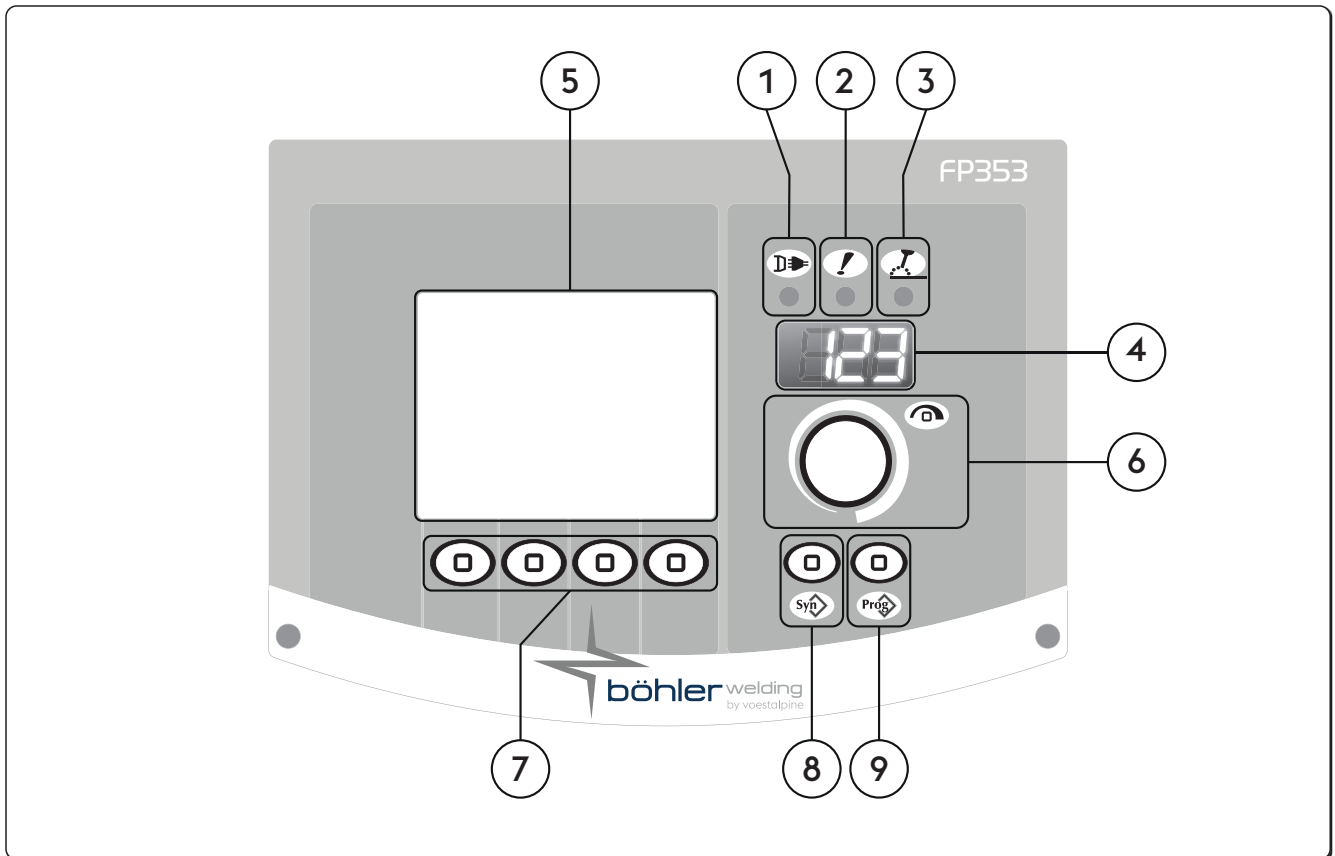

- ① **LED for strømtilførsel**
Viser at utstyret er tilkoplett nettet og er på.
- ② **LED for generell alarm**
Indikerer mulig påvirkning av en beskyttelsesenhets så som temperaturbeskyttelse.
- ③ **LED for aktivert effekt**
Indikerer at det er spenning på utstyrets spenningsuttak.
- ④ **Signalkabel CAN-BUS inngang (RC, RI...)**

3.4 Frontpanel med kontroller



- 1  **LED for strømtilførsel**
Viser at utstyret er tilkoplek nettet og er på.
- 2  **LED for generell alarm**
Indikerer mulig påvirkning av en beskyttelsesenhet så som temperaturbeskyttelse.
- 3  **LED for aktivert effekt**
Indikerer at det er spenning på utstyrets spenningsuttak.
- 4  **7-segment skjerm**
Viser de generelle sveisemaskinparametrene under oppstart, settinger, strøm og spenningsverdier under sveising, og koding av alarmer.
- 5  **LCD skjerm**
Viser de generelle sveisemaskinparametrene under oppstart, settinger, strøm og spenningsverdier under sveising, og koding av alarmer.
Tillater alle operasjoner å bli vist øyeblikkelig.
- 6  **Hovedjusteringshendelen**
Tillater å tilføre oppsett, valg og setting av sveiseparameter.
- 7  **Funksjonsknapp**
Lar deg velge forskjellige systemfunksjoner:
- Sveiseprosess
- Sveisemetoder
- Strømpulsing
- Grafisk metode

8 Programknapp

Lar deg velge et presatt sveiseprogram ved å velge noen få enkle settinger:

- Trådtype
- Type gass
- Tråddiameter

9 Job-tast

Tillater lagring og administrasjon av 240 sveiseprogram som kan personaliseres av operatøren.

4. BRUK AV UTSTYRET

4.1 Startskjerm

Når den slås på, utfører generatoren en rekke kontroller for å garantere korrekt operasjon av systemet og av alt utstyret som er tilkopleet den. På dette trinn utføres også gasstesten for å sjekke riktig tilkøpling til gassforsyningssystemet.

4.2 Testskjerm

Når sidepanelet (spolerrommet) er åpent, er sveiseoperasjonene forhindret fra kjøring.

Testskjermen fremstår på LCD-skjermen.

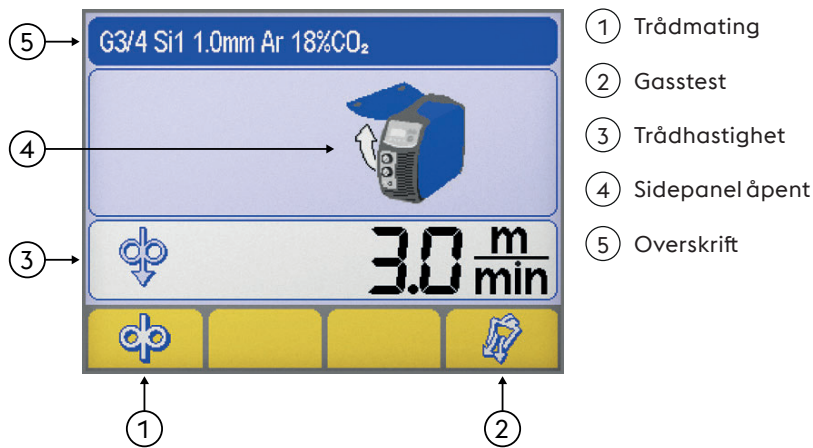

Trådmating

Muliggjør manuell trådmating uten gassflyt og uten tråd innsatt.

Tillater innføring av tråd i brennerkappen under forberedelsesfasen for sveising.



Gasstest

Lar gasskretsen bli rensset for urenheter, og utføring av justering av passende innledende trykk på gasstrykk og flyt, uten spenning på.



Trådhastighet

Tillater regulering av matehastigheten for tråden (under lasting trinnet).

Minimum	Maksimum	Standard
0.5 m/min	22.0 m/min	3.0 m/min



Sidepanel åpent



Overskrift

Gir visning av visse deler av viktig informasjon relatert til den valgte prosess.

4.3 Hovedskjerm

Tillater kontroll av systemet og av sveiseprosessen ved å vise hovedsettingene.

4.4 Hovedskjerm bilde MMA-prosess

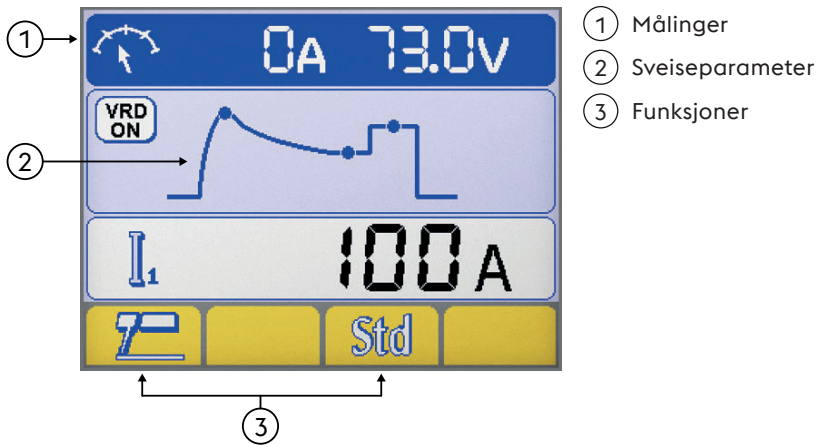

Målinger

Under sveiseoperasjonen, er reell strøm og spenningsmålinger vist på LCD-skjermen.

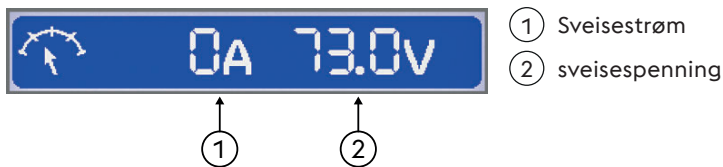

Sveiseparameter

► Velg det ønskede parameter ved å trykke på encodernappen.

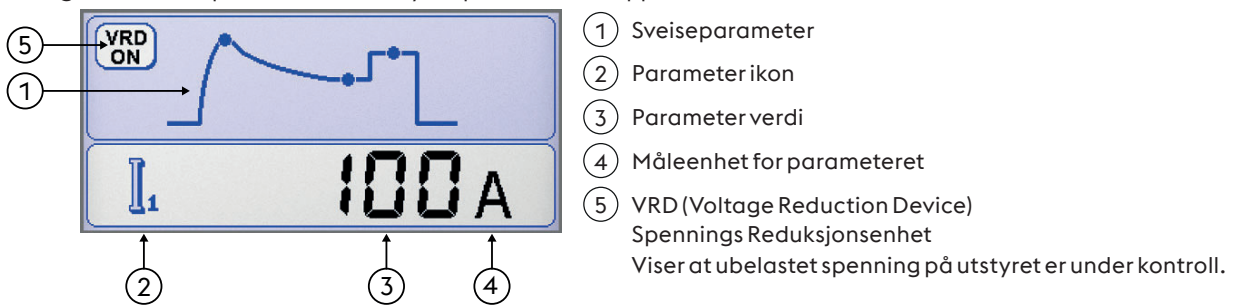

Funksjoner

Tillater setting av de mest viktige prosessfunksjonene og sveisemetoder.

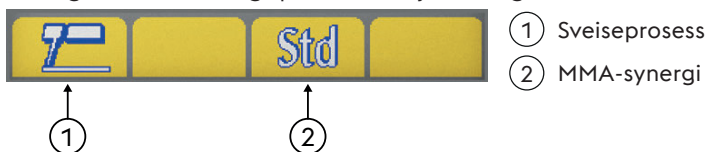

Sveiseprosess





MMA-synergi

For å stille in den beste buedynamikken ved å velge brukt elektrodetype.

Ved å velge korrekt buedynamikk oppnås maksimum fordeler å bli utledet fra spenningstilførselen i den hensikt å oppnå den best mulige sveiseytelse.



Perfekt sveiseresultat med den brukte elektrode er ikke garantert.

Sveiseresultat avhenger av kvaliteten på slidedeler og deres oppbevaring, operasjons- og sveiseforhold, tallrike mulige applikasjoner etc.

4.5 Hovedskjerm bilde TIG-prosess



Målinger

Under sveiseoperasjonen, er reell strøm og spenningsmålinger vist på LCD-skjermen.

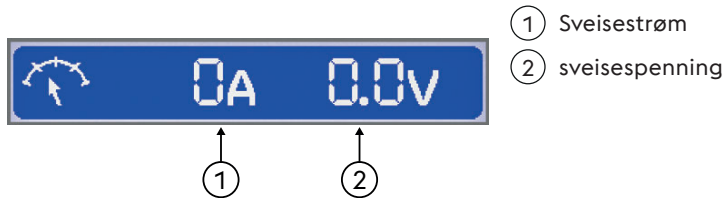

Sveiseparameter

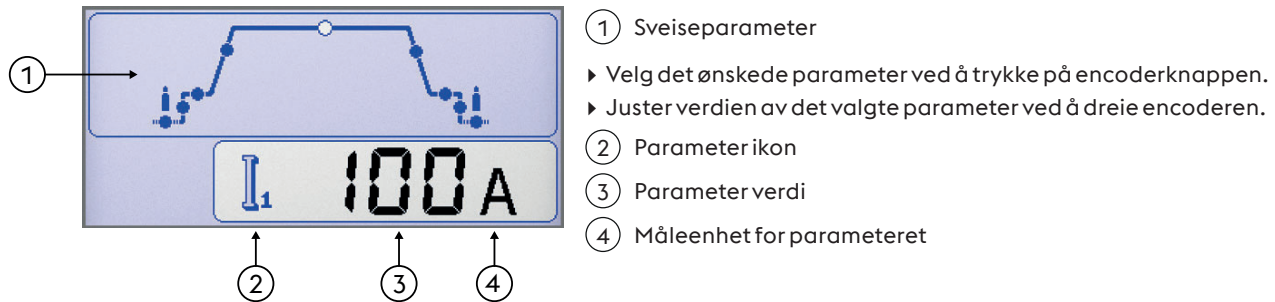

Funksjoner

Tillater setting av de mest viktige prosessfunksjonene og sveisemetoder.

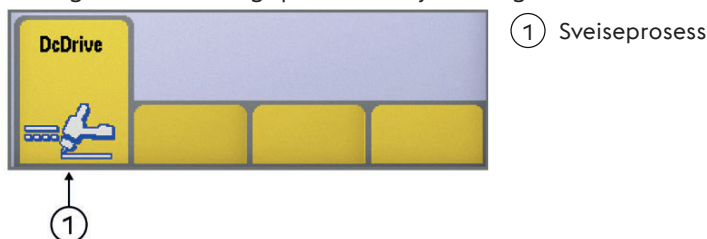



Sveiseprosess

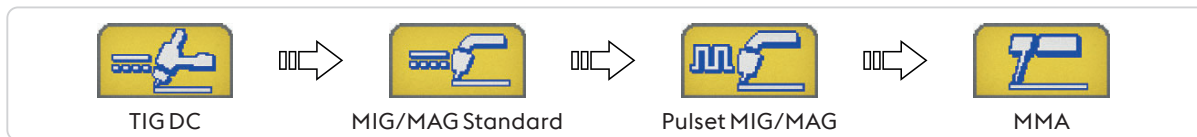

4.6 Hovedskjerm bilde MIG/MAG-prosess

Standard skjerm bilde

① Overskrift MIG/MAG
② Sveiseparameter
③ Funksjoner

Grafisk skjerm bilde

① Overskrift MIG/MAG
② Sveiseparameter
③ Funksjoner

Overskrift MIG/MAG

Gir visning av visse deler av viktig informasjon relatert til den valgte prosess.

G3/4 Si1 1.0mm Ar 18%CO₂

- ①
- ②
- ③

Synergikurve valgt

- ① Type fyllmetall
- ② Tråddiameter
- ③ Type gass

I 118A 2.2mm 3.4mm V 19.5V

- ①
- ②
- ③
- ④

Sveiseparameter

- ① Sveisestrøm
- ② Arbeidsstykkets tykkelse
- ③ Hjørneforbindelse
- ④ sveisespenning

NO

Sveiseparameter (Standard skjermbilde)

► Velg det ønskede parameter ved å trykke på encoderknappen.

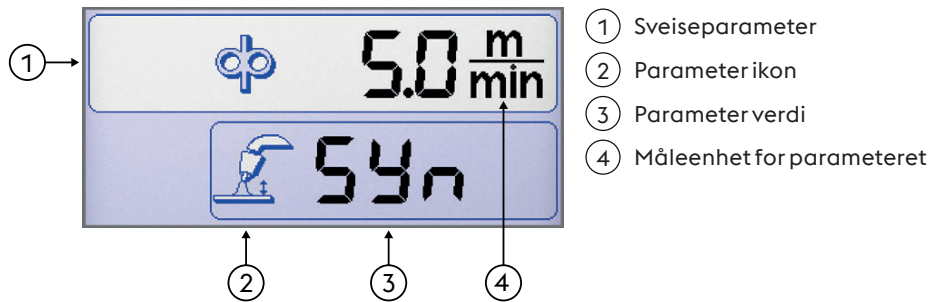

Sveiseparameter (Grafisk skjermbilde)

► Velg det ønskede parameter ved å trykke på encoderknappen.

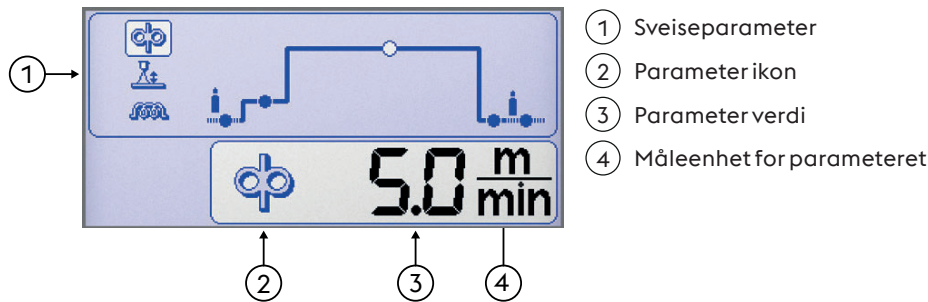

Funksjoner

Tillater setting av de mest viktige prosessfunksjonene og sveisemetoder.

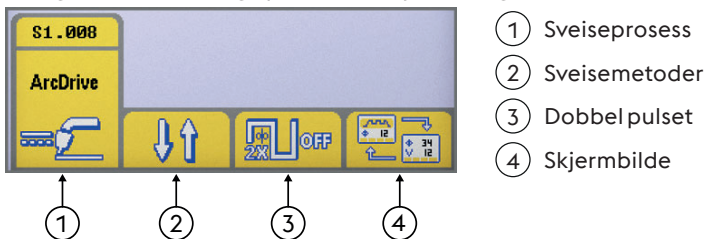

Sveiseprosess



Sveisemetoder

Gir valg av sveisemetoden

2 Trinn

I to trinn, trykke knappen får gassen til å strømme, mater spenning til tråden og får den til å trekkes frem; når den slippes, stenges gassen, spenningen og trådmatingen slås av.

4 Trinn

I fire trinn, første trykk på knappen får gassen til å strømme med en manuell pre-gasstid; slippe den aktiverer spenningen til tråden og dens mating. Påfølgende trykk på knappen stopper tråden og starter sluttprosessen, som bringer strømmen tilbake til null; ved da å slippe knappen stenges gassflyten.

Crater filler

Lar sveising bli gjort med tre forskjellige effektnivå som kan velges direkte og kontrollert av sveiseren ved bruk av brennerknappen.

Første trykk på knappen får gassen til å strømme, aktiverer spenning til tråden og mater den med en hastighet satt med parameteret "initielt inkrement" (under oppsettet) og med de relative synergivardiene a sveiseparametrene.

Når brennerknappen slippes, endres trådhastigheten og de relative synergiparametrene automatisk til hovedverdiene satt på kontrollpanelet.

Neste trykk på brennerknappen bringer trådhastigheten og de relative synergiparametrene til de pre-satte (under oppsettet) kraterfyller parameterverdiene.

Ved å slippe brennerknappen stopper trådmatingen og forsyner effekt for burn back og etter-gass trinnene.



Dobbel pulset



Dobbel pulset aktivert



Dobbel pulset ikke aktivert

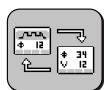

Skjerm bilde

Tillater endringen av visning mellom:



Standard skjerm bilde



Grafisk skjerm bilde

Skjermen synergikurver





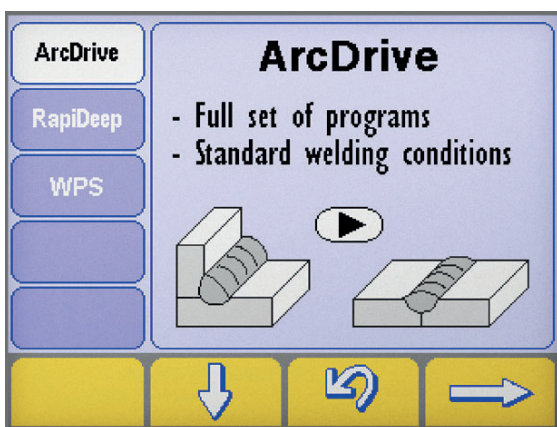

Synergi

Lar deg velge et presatt sveiseprogram (synergi) ved å velge noen få enkle settinger

Valg av sveise prosess



- ▶ Gå inn i skjermbildet "synergi" og trykk på knappen  i minst ett sekund.
- ▶ Velg ønsket sveise prosess ved å trykke på  e 
- ▶ Trykk på knappen  for å gå til neste trinn.



Sveise prosess

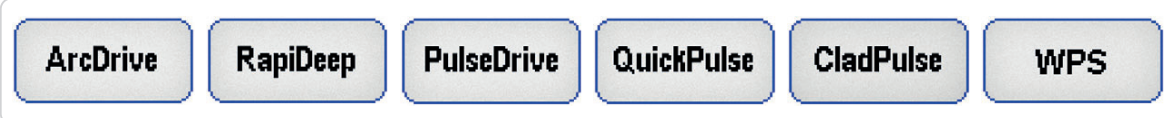

Skjerm bilde for valg av synergi Materialtype/gasstype

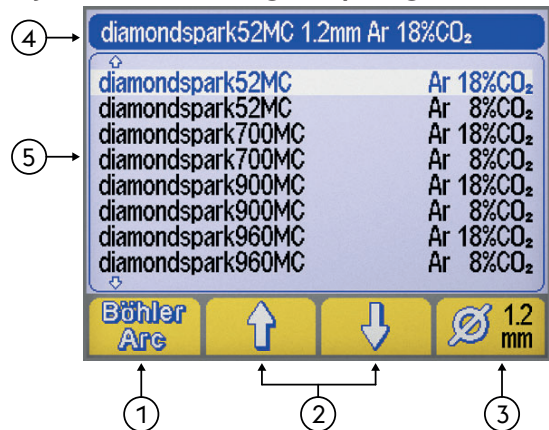

- ① Sveiseprogram (BöhlerArc/UniversalArc)
- ② Valg av materiale/gass
- ③ Tråddiameter
- ④ Overskrift
- ⑤ Sveiseprogram



Sveiseprogram

Gir valg av sveiseprogram



BöhlerArc



UniversalArc



Valg av materiale/gass

Lar deg velge:



• Type fyllmetall

• Type gass

NO

**Tråddiameter**

Muliggjør valg av tråddiameter (mm).

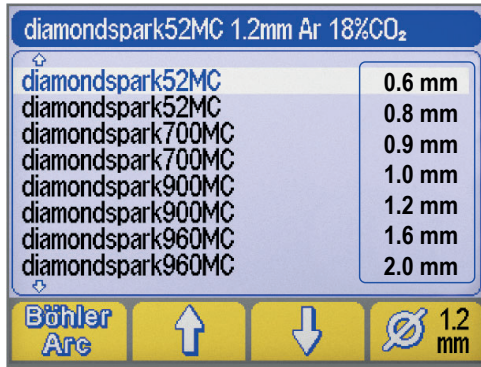

① Tråddiameter

**Overskrift**

Gir visning av visse deler av viktig informasjon relatert til den valgte prosess.

**NO PROGRAM**

Indikerer at det valgte synergiprogrammet ikke er tilgjengelig, eller passer ikke med de andre systemsettingene.

4.7 Programskjerm

Tillater lagring og administrasjon av 240 sveiseprogram som kan personaliseres av operatøren.

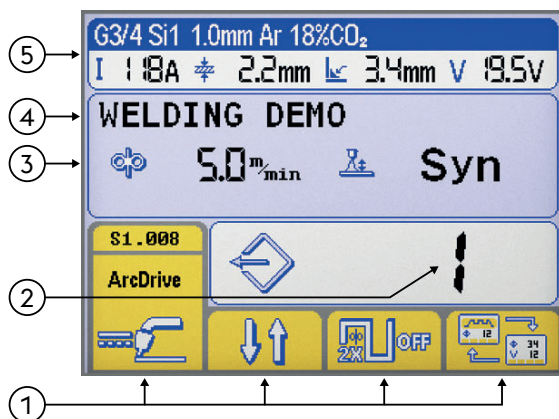
Programmer (JOB)

① Funksjoner

② Nummer på det valgte program

③ Hovedparameter for det valgte program

④ Beskrivelse av det valgte program

⑤ Overskrift

①

Se seksjon "Hovedskjerm"

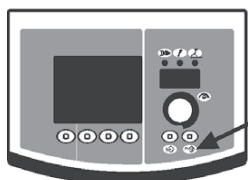
Program lagring▶ "program lagring"-menyen ved å trykke knapp.  i minst ett sekund.



▶ Velg ønsket program (eller det tomme minne) ved dreiring av encodere.

--- Minne tomt

 **Program lagret**▶ Bekreft operasjonen ved å trykke knappen .▶ Lagre alle aktuelle settinger for det valgte program ved å trykke knappen .





Gi en beskrivelse av programmet.

- ▶ Velg ønsket bokstav ved å dreie encoderen.
- ▶ Lagre valgt bokstav ved å trykke encoderen.
- ▶ Kanseller den siste bokstav ved å trykke knapp .
- ▶ Bekreft operasjonen ved å trykke knappen .
- ▶ Bekreft operasjonen ved å trykke knappen .





Lagring av et nytt program på et allerede okkupert minneområde, krever sletting av minneområdet med en obligatorisk prosedyre.

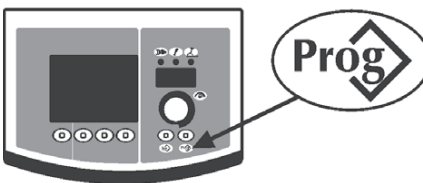

- ▶ Bekreft operasjonen ved å trykke knappen .
- ▶ Fjern det valgte program med å trykke knapp. .
- ▶ Gjenta lagringsprosedyren.

Program henting





- ▶ Hent frem første program tilgjengelig ved å trykke knapp .
- ▶ Velg ønsket program ved å dreie encoderen.
- ▶ Velg ønsket program ved å trykke knapp. .





Bare minneområder som er okkupert av et program blir hentet frem, mens de ledige områder automatisk blir droppet.

Program kansellering



- ▶ Velg ønsket program ved å dreie encoderen.
- ▶ Fjern det valgte program med å trykke knapp. .
- ▶ Bekreft operasjonen ved å trykke knappen .



- ▶ Bekreft operasjonen ved å trykke knappen .
- ▶ Fjern det valgte program med å trykke knapp. .

5. INNSTILLING

5.1 Oppsett og innstillinger av parametrene

Muliggjør innstilling og regulering av en serie ekstre parameter for en bedre og mer eksakt håndtering av sveiseanlegget. Parametrene som er inkludert i innstillingen er organisert i samsvar med den sveiseprosess du har valgt og har et kodenummer.

For å utføre innstillingsprosedyren



- ▶ Utføres ved å trykke på encoder-knappen i 5 sekunder.
- ▶ Tilgangen bekreftes av teksten 0 på displayet.

Valg og regulering av ønsket parameter

- ▶ Skjer ved å dreie kodeenheten til den viser kodenummeret som gjelder ønsket parameter.
- ▶ Hvis du trykker på enkodertasten, kan du få vist innstilt verdi for valgt parameter og dens regulering.

For å gå ut fra innstillingsmodus

- ▶ For å gå ut fra seksjonen "regulering", skal du trykke på enkodertasten igjen.
- ▶ For å gå ut fra innstillingsmodus, kan du stille deg på parameter "0" (lagre og gå ut) og trykke på enkodertasten.
- ▶ Bekreft operasjonen ved å trykke knappen .
- ▶ For å lagre endringen og gå ut av set up, trykk på: .

5.1.1 Liste med parametere for innstilling (MMA)

0

Lagre og gå ut

For å lagre endringene og gå ut fra innstillingsmodus.



1

Reset

For å tilbakestille alle standard parametrene.



3

Hot start

Muliggjør regulering av verdien for hot start i MMA.

Tillater en oppstart som er mer eller mindre "varm" i fasene for buens aktivering, for å lette oppstart.



Basisk elektrode

Minimum	Maksimum	Standard
0/av	500%	80%

Cellulose elektrode

Minimum	Maksimum	Standard
0/av	500%	150%

CrNi elektrode

Minimum	Maksimum	Standard
0/av	500%	100%

Aluminiums elektrode

Minimum	Maksimum	Standard
0/av	500%	120%

Støpejerns elektrode

Minimum	Maksimum	Standard
0/av	500%	100%

7

Sveisestrøm

For regulering av sveisestrømmen.

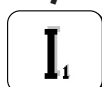

Minimum	Maksimum	Standard
3 A	I _{max}	100 A

8 Arc force

For å regulere verdien Arc force i MMA.

Gjør at du oppnår dynamiske svar som er mer eller mindre energisk under sveisingen, for å lette sveiserens arbeid. Økning av verdien på buen medfører reduksjon av risikoen for klebing av elektroden.

Basisk elektrode

Minimum	Maksimum	Standard
0/av	500%	30%

Cellulose elektrode

Minimum	Maksimum	Standard
0/av	500%	350%

CrNi elektrode

Minimum	Maksimum	Standard
0/av	500%	30%

Aluminiums elektrode

Minimum	Maksimum	Standard
0/av	500%	100%

Støpejerns elektrode

Minimum	Maksimum	Standard
0/av	500%	70%

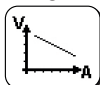
204 Dynamic power control (DPC)

Det aktiverer valget av den ønskede V/I karakteristikk.

I=C Konstant strøm

Økning eller reduksjon av buehøyde har ingen effekt på nødvendig sveisestrøm.

Anbefalt for elektrode: Basisk, Rutil, Syre, Stål, Støpjern

1:20 Reduksjon av kontroll på stigningsforhold

Økning i buehøyde gir en reduksjon i sveisestrøm (og vice versa) i henhold til verdien lagt inn med 1 til 20 A per volt.

Anbefalt for elektrode: Cellulose, Aluminium

P=C Konstant effekt

Økning i buehøyden gir en reduksjon i sveisestrømmen (og vice versa) i henhold til loven: $V \cdot I = K$

Anbefalt for elektrode: Cellulose, Aluminium

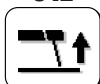
312 Spenning for buefjerning

Gjør at du kan stille inn spenningsverdien som skal brukes for å slokke den elektriske buen.

For en bedre håndtering av de ulike funksjonsbetingelsene som oppstår.

Under punktveisingen for eksempel, gjør en lav buespenning at gnisten blir mindre når du flytter elektroden fra stykket, og dette minker sprut, brenning og oksidering av stykket.

Hvis du bruker elektroder som trenger høy spenning, anbefaler vi deg å stille inn en høy verdi for å unngå at buen slukker under sveisingen.



Still aldri inn en spenning for fjerning av buen som overstiger generatorens tomgangsspenning.

Basisk elektrode

Minimum	Maksimum	Standard
0/av	99.9 V	57.0 V

Cellulose elektrode

Minimum	Maksimum	Standard
0/av	99.9 V	70.0 V

399 Tillater visningen av skjærehastighet.

Lar deg sette sveisehastighet.

Default cm/min: referansehastighet for manuell sveising.

Syn: Sinergic verdi.

Minimum	Maksimum	Standard
1 cm/min	200 cm/min	15 cm/min

500 Innstilling av maskin

Tillater valg av det nødvendige grafiske grensesnitt.

Gir tilgang til høyere oppsettnivåer.

Konsulter seksjon "Grensesnitt personalisering (Set up 500)"

Verdi	Bruker grensesnitt	Verdi	Valgt nivå
XE	Easy-modus	USER	Bruker
XA	Avansert-modus	SERV	Service
XP	Profesjonell-modus	vaBW	vaBW

NO

551 Lock/unlock
 Tillater låsing av panelkontrollene og innsettingen av en beskyttelseskode.
 Konsulter seksjon "Lock/unlock (Set up 551)".

552 Akustisk signal
 For regulering av lyden på det akustiske signalet.

Minimum	Maksimum	Standard
0/av	10	10

601 Reguleringsstepp
 Tillater reguleringen av et parameter med et stepp som kan bli personalisert av operatøren.

Minimum	Maksimum	Standard
1	Imax	1

602 Eksternt parameter CH1, CH2, CH3, CH4
 Tillater administrasjon av det eksterne parameter 1, 2, 3, 4 (minimum verdi, maksimum verdi, standard verdi, parameter valgt).
 Konsulter seksjon "Ekstern kontrolladministrasjon (Set up 602)".

705 Kalibrering kretsmotstand
 Tillater kalibrering av anlegget.
 Konsulter seksjon "Kalibrering kretsmotstand (set up 705)".

751 Strømvlesing
 Tillater visning av den reelle verdien av sveisestrømmen.

752 Spenningsavlesing
 Tillater visning av den reelle verdien av sveisespenningen.

768 Måling varmetilførsel HI
 Tillater avlesning av måleverdien for varmetilførselen ved sveising.

5.1.2 Liste over setup-parametere (TIG)

0 Lagre og gå ut
 For å lagre endringene og gå ut fra innstillingsmodus.

1 Reset
 For å tilbakestille alle standard parametrene.

7 Sveisestrøm
 For regulering av sveisestrømmen.

Minimum	Maksimum	Standard
3 A	Imax	100 A

399 Tillater visningen av skjærehastighet.
 Lar deg sette sveisehastighet.
 Default cm/min: referansehastighet for manuell sveising.
 Syn: Sinergic verdi.

Minimum	Maksimum	Standard
1 cm/min	200 cm/min	10 cm/min

NO

500 Innstilling av maskin

Tillater valg av det nødvendige grafiske grensesnitt.
 Gir tilgang til høyere oppsettnivåer.
 Konsulter seksjon "Grensesnitt personalisering (Set up 500)"

Verdi	Brukergrensesnitt
XE	Easy-modus
XA	Avansert-modus
XP	Profesjonell-modus

Verdi	Valgt nivå
USER	Bruker
SERV	Service
vaBW	vaBW

551 Lock/unlock

Tillater låsing av panelkontrollene og innsettingen av en beskyttelseskode.
 Konsulter seksjon "Lock/unlock (Set up 551)".

552 Akustisk signal

For regulering av lyden på det akustiske signalet.

Minimum	Maksimum	Standard
0/av	10	10

601 Reguleringsstepp

Tillater reguleringen av et parameter med et stepp som kan bli personalisert av operatøren.

Minimum	Maksimum	Standard
1	lmax	1

602 Eksternt parameter CH1, CH2, CH3, CH4

Tillater administrasjon av det eksterne parameter 1, 2, 3, 4 (minimum verdi, maksimum verdi, standard verdi, parameter valgt).

Konsulter seksjon "Ekstern kontrolladministrasjon (Set up 602)".

705 Kalibrering kretsmotstand

Tillater kalibrering av anlegget.

Konsulter seksjon "Kalibrering kretsmotstand (set up 705)".

751 Strømvlesing

Tillater visning av den reelle verdien av sveisestrømmen.

752 Spenningsavlesing

Tillater visning av den reelle verdien av sveisespenningen.

755 Gassflyt lesing (WFR)

Muliggjør visning av verdien på reell gassflyt.

757 Trådhastighet

Avlesing av encoder til motor 1.

760 Strømvlesing (motor 1)

Tillater visning av den reelle verdien av motorensstrømmen (motor 1).

764 Avlesing av kjølevæskeflyt

Tillater visning av den verdien av kjølevæskeflyt.

NO

765 Kjølevæsketemperatur lesing



Tillater visning av den reelle verdien av Kjølevæsketemperatur.

768 Måling varmetilførsel HI



Tillater avlesning av måleverdien for varmetilførselen ved sveising.

801 Vaktgrenser



Muliggjør setting av varselgrenser og av vaktgrenser. Lar sveiseprosessen bli kontrollert ved å sette varselgrenser og vaktgrenser for de målbare hoved- parameter. Tillater nøyaktig kontroll av de forskjellige sveisefaser. Konsulter seksjon "Vaktgrenser (Set up 801)".

5.1.3 Liste over setup-parametere (MIG/MAG)

0 Lagre og gå ut



For å lagre endringene og gå ut fra innstillingsmodus.

1 Reset



For å tilbakestille alle standard parametrene.

2 Synergi



MIG/MAG Standard:

Muliggjør valg av den manuelle MIG (◇ Off) eller synergisk MIG-prosess (◇ 6) ved å sette typen material som skal sveises.

Pulset MIG/MAG:

Muliggjør valg av den synergisk MIG-prosess (◇ 6) ved å sette typen material som skal sveises. Muliggjør valg av den CC/CV-prosess.

3 Trådhastighet



Tillater regulering av matehastigheten for tråden.

Minimum	Maksimum	Standard
0.5 m/min	22.0 m/min	-

4 Strøm



For regulering av sveisestrømmen.

Minimum	Maksimum
3 A	I _{max}

5 Arbeidsstykkets tykkelse



Tillater setting av tykkelsen på delen som sveises. Tillater setting av systemet via regulering av delen som sveises.

6 Hjørneforbindelse "a"



Lar deg sette forbindelsesdybden i et hjørnepunkt.

7 Spenning - buelengde



Tillater regulering av buespenningen. Tillater regulering av buelengden under sveising.

Høy C = lang bue
Lav V = kort bue

Manuell sveising

Minimum	Maksimum	Standard
5.0 V	55.5 V	5.0 V

10 Pre gass

For å stille inn og regulere gassflyten før buen blir aktivert.
 Muliggjør fylling av gass i sveisebrenneren og forberedemiljøet for sveiseprosedyren.

Minimum	Maksimum	Standard
0/av	99.9 s	0.1 s

11 Soft start

For å regulere trådens matehastighet i fasene før aktiveringen.
 For en aktivering med redusert hastighet og mykere oppstart med mindre sprut.

Minimum	Maksimum	Standard
10 %	100 %	50 %

12 Motorens ramp

Muliggjør innstilling av en gradert overgang mellom trådens aktiveringshastighet og sveisehastigheten.

Minimum	Maksimum	Standard
0/av	1.0 s	0/av

15 Burn back



Muliggjør regulering av trådens brennetid for å forhindre klebing ved sveiseprosedyrens slutt.
 Muliggjør reguleringen av trådens lengde utenfor sveisebrenneren.

Minimum	Maksimum	Standard
-2.00	+2.00	0/syn

16 Ettergass

For regulering av gassflyten ved sveisingens slutt.

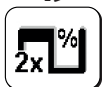
Minimum	Maksimum	Standard
0/av	99.9 s	2.0 s

19 Duty cycle (Dobbel pulset)

Gjør det mulig å sette tiden hvorfra sluttstrømmen bibeholdes.

Minimum	Maksimum	Standard
10 %	90 %	50 %

20 Dobbel pulset

Tillater regulering av pulseringens amplitude.

Minimum	Maksimum	Standard
0 %	100 %	±25 %

Minimum	Maksimum	Standard
0.5 m/min	22 m/min	2.5 m/min

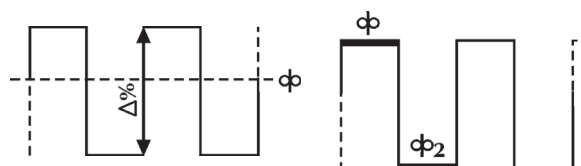
21 Puls frekvens (Dobbel pulset)

Tillater regulering av takten, d.e. av impulsens repetisjonstakt.
 Tillater impulsfrekvensen å bli regulert.

Minimum	Maksimum	Standard
0.1 Hz	5.0 Hz	2.0 Hz

22 Sekundær spenning (Dobbel pulset)

Tillater regulering av det sekundære pulserings spenningsnivå.
 Gjør det mulig å oppnå større buestabilitet under de forskjellige pulseringsfaser.

Minimum	Maksimum	Standard
-5.0	+5.0	0/syn

23 Pulset helling (Dobbel pulset)

Tillater setting av stigetid under pulsoperasjonen.

Minimum	Maksimum	Standard
1 %	100 %	50 %

NO

24 Bilevel (4T - crater filler)

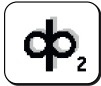

For regulering av sekundærtrådhastighet i modus for binivå-sveising.

Hvis sveiserarbeideren trykker og siden hurtig slipper knappen, overgår enheten til "Φ₂".

Hvis han trykker og hastig slipper knappen igjen, overgår enheten igjen til "Φ" osv.

Minimum	Maksimum	Standard
1 %	200 %	0/av

25 Startinkrement



Tillater regulering av verdien på trådhastigheten under den første "krater-fyller" sveisefase.

Gjør det mulig å øke energien tilført delen under fasen når materialet (fortsatt kaldt) trenger mere varme for å smelte jevnt.

Minimum	Maksimum	Standard
20 %	200 %	120 %

26 Crater filler

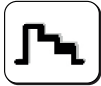

Tillater regulering av verdien på trådhastigheten under sveisens slutfase.

Gjør det mulig å redusere energien tilført delen under fasen når materialet allerede er meget varmt, og således redusere risikoen for uønsket deformeringer.

Minimum	Maksimum	Standard
20 %	200 %	80 %

27 Start inkrementtid



Lar deg sette start inkrementtid.

Automatiserer "kraterfyller"-funksjonen.

Minimum	Maksimum	Standard
0.1 s	99.9 s	0/av

28 Kraterfyller tid



Lar deg sette "kraterfyller" tid.

Automatiserer "kraterfyller"-funksjonen.

Minimum	Maksimum	Standard
0.1 s	99.9 s	0/av

30 Punktveising

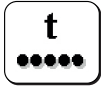

Lar deg aktivere "punktveising"-prosessen og sette opp sveisetid.

Minimum	Maksimum	Standard
0.1 s	99.9 s	0/av

31 Pausepunkt

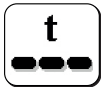

Muliggjør aktiveringen av prosessen "pausepunkt" og beregning av pausetiden mellom en sveisesyklus og en annen.

Minimum	Maksimum	Standard
0.1 s	99.9 s	0/av

32 Sekundær spenning (Binivå MIG)



Tillater regulering av det sekundære pulserings spenningsnivå.

Gjør det mulig å oppnå større buestabilitet under de forskjellige pulseringsfaser.

Minimum	Maksimum	Standard
-5.0	+5.0	0/syn

33 Sekundær induktans (Binivå MIG)



Tillater regulering av det sekundære pulserings induktans.

Gjør det mulig å oppnå en raskere eller saktere bue for å kompensere for sveiserens bevegelser og for den naturlige ustabilitet i sveising.

Lav induktans = reaktiv bue (mere sprut).

Høy induktans = mindre reaktiv bue (mindre sprut).

Minimum	Maksimum	Standard
-30	+30	0/syn

NO

34 Rampe for startinkrement

Brukes for å innstille en gradvis overgang mellom startinkrementet og sveisingen.

Minimum	Maksimum	Standard
0 s	10 s	0/av

35 Rampe for kraterfyller

Brukes for å innstille en gradvis overgang mellom sveisingen og kraterfylleren.

Minimum	Maksimum	Standard
0 s	10 s	0/av

202 Induktans

Tillater elektronisk regulering av serieinduktansen i sveisekretsen.

Gjør det mulig å oppnå en raskere eller saktere bue for å kompensere for sveiserens bevegelser og for den naturlige ustabilitet i sveising.

Lav induktans = reaktiv bue (mere sprut).

Høy induktans = mindre reaktiv bue (mindre sprut).

Minimum	Maksimum	Standard
-30	+30	0/syn

331 Kompensert gjennomsnittsspennning

Lar deg sette sveisespenning.

399 Tillater visningen av skjærehastighet.

Lar deg sette sveisehastighet.

Default cm/min: referansehastighet for manuell sveising.

Syn: Sinergic verdi.

Minimum	Maksimum	Standard
syn min	syn max	35 cm/min

500 Innstilling av maskin

Tillater valg av det nødvendige grafiske grensesnitt.

Gir tilgang til høyere oppsettnivåer.

Konsulter seksjon "Grensesnitt personalisering (Set up 500)"

Verdi	Brukergrensesnitt	Verdi	Valgt nivå
XE	Easy-modus	USER	Bruker
XA	Avansert-modus	SERV	Service
XP	Profesjonell-modus	vaBW	vaBW

551 Lock/unlock

Tillater låsing av panelkontrollene og innsettingen av en beskyttelseskode.

Konsulter seksjon "Lock/unlock (Set up 551)".

552 Akustisk signal

For regulering av lyden på det akustiske signalet.

Minimum	Maksimum	Standard
0/av	10	10

601 Reguleringsstepp

Tillater reguleringen av et parameter med et stepp som kan bli personalisert av operatøren.

Funksjonalitet styrt av knappen for fakkell opp / ned.

Minimum	Maksimum	Standard
1	Imax	1

602 Eksternt parameter CH1, CH2, CH3, CH4

Tillater administrasjon av det eksterne parameter 1, 2, 3, 4 (minimum verdi, maksimum verdi, standard verdi, parameter valgt).

Konsulter seksjon "Ekstern kontrolladministrasjon (Set up 602)".

NO

606 U/D brenner



Tillater administrasjon av det eksterne parameter (U/D).

Verdi	Standard	Tilbakeringingsfunksjon
0/av	-	av
1/11	X	Strøm
	-	Program henting

705 Kalibrering kretsmotstand



Tillater kalibrering av anlegget.

Konsulter seksjon "Kalibrering kretsmotstand (set up 705)".

751 Strømvlesing



Tillater visning av den reelle verdien av sveisestrømmen.

752 Spenningsavlesing



Tillater visning av den reelle verdien av sveisespenningen.

755 Gassflyt lesing (WFR)



Muliggjør visning av verdien på reell gassflyt.

757 Tråd hastighet



Avlesing av encoder til motor 1.

758 Robot bevegelse hastighet



Muliggjør visning av bevegelse hastigheten på armen av en robot eller en automasjonsenhet.

760 Strømvlesing (motor 1)



Tillater visning av den reelle verdien av motorensstrømmen (motor 1).

761 Tråd hastighet



Avlesing av encoder til motor 2.

762 Strømvlesing (motor 2)



Tillater visning av den reelle verdien av motorensstrømmen (motor 2).

763 Tråd hastighet



Reell avlesning av trådens fremtrekk

764 Avlesing av kjølevæskeflyt



Tillater visning av den verdien av kjølevæskeflyt.

NO

765 Kjølevæsketemperatur lesing

Tillater visning av den reelle verdien av Kjølevæsketemperatur.

768 Måling varmetilførsel HI

Tillater avlesning av måleverdien for varmetilførselen ved sveising.

801 Vaktgrenser

Muliggjør setting av varselgrenser og av vaktgrenser.

Lar sveiseprosessen bli kontrollert ved å sette varselgrenser og vaktgrenser for de målbare hoved- parameter.

Tillater nøyaktig kontroll av de forskjellige sveisefaser.



Konsulter seksjon "Vaktgrenser (Set up 801)".

5.2 Spesifikke prosedyrer for bruk av parameterene

5.2.1 Personalisering 7-segment visning

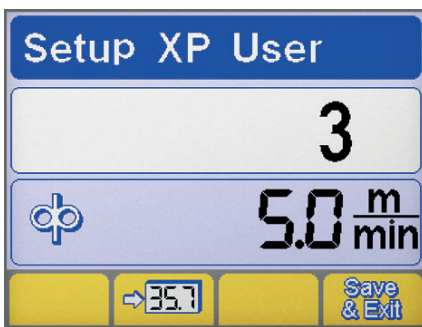
Tillater å hele tiden vise verdien til en parameter på 7-segment displayet.



- ▶ Gå inn i oppsett ved å trykke encoderknappen i minst 5 sekunder.
- ▶ Velg ønsket parameter ved å dreie encoderen.
- ▶ Lagre det valgte parameter i 7-segment visning ved å trykke knappen .
- ▶ Lagre og gå ut av nåværende skjerm ved å trykke knappen .

5.2.2 Grensesnitt personalisering (Set up 500)















Tillater parametrene å bli tilpasset på hovedmenyen.

500 Innstilling av maskin

Tillater valg av det nødvendige grafiske grensesnitt.

Verdi	Brukergrennesnitt
XE	Easy-modus
XA	Avansert-modus
XP	Profesjonell-modus

MODUS XE

MMA	
Sveiseparameter	
TIG	
Sveiseparameter	
Funksjoner	      
MIG/MAG	
Sveiseparameter	 
Funksjoner	  

NO

MODUS XA

MMA	
Sveiseparameter	
Funksjoner	
TIG	
Sveiseparameter	
Funksjoner	
MIG/MAG	
Sveiseparameter	
Funksjoner	

MODUS XP

MMA	
Sveiseparameter	
Funksjoner	
TIG	
Sveiseparameter	
Funksjoner	
MIG/MAG	
Sveiseparameter	
Funksjoner	

5.2.3 Lock/unlock (Set up 551)

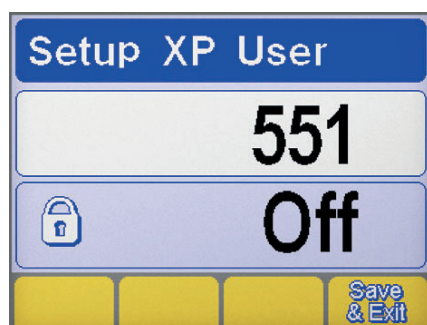

Tillater låsing av panelkontrollene og innsettingen av en beskyttelseskode.

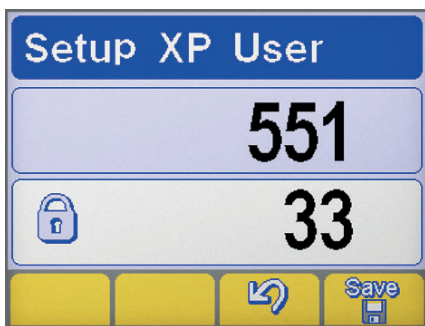

Valg av parameter

- ▶ Gå inn i oppsett ved å trykke encoderknappen i minst 5 sekunder.
- ▶ Velg det ønskete parameter (551).
- ▶ Aktiver reguleringen av det valgte parameter ved å trykke encoderknappen.





- ▶ Sett en tallkode (passord) ved å dreie encodere.
- ▶ Trykk på encoder-knappen for å bekrefte oppgaven.
- ▶ Bekreft operasjonen ved å trykke knappen .
- ▶ For å lagre endringen, trykk på: .

Panelfunksjoner

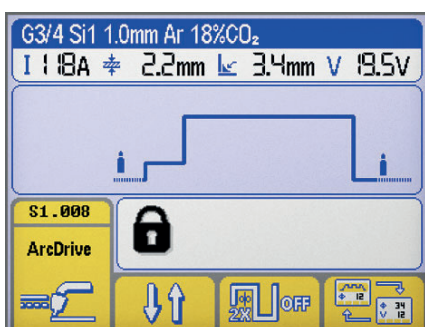

Utføring av enhver operasjon på et låst kontrollpanel medfører at en spesiell skjerm fremtrer.



- ▶ Gå til panelfunksjonaliteter midlertidig (5 minutter) ved å dreie encodere og legg inn riktig passord.
- ▶ Trykk på encoder-knappen for å bekrefte oppgaven.
- ▶ Lås opp kontrollpanelet definitivt ved å gå inn i oppsett (følg instruksjonene gitt ovenfor) og bring parameter 551 tilbake til "av".
- ▶ Trykk på encoder-knappen for å bekrefte oppgaven.
- ▶ For å lagre endringen, trykk på: .

5.2.4 Ekstern kontrolladministrasjon (Set up 602)

Tillater administrasjon av det eksterne parameter 2 (minimum verdi, maksimum verdi, standard verdi, parameter valgt).



Valg av parameter

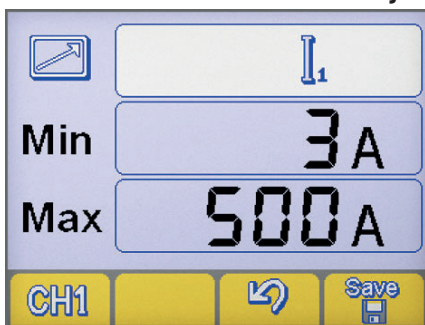

- ▶ Gå inn i oppsett ved å trykke encoderknappen i minst 5 sekunder.
- ▶ Velg det ønskete parameter (602).
- ▶ Gå inn i skjermen for "Ekstern kontrolladministrasjon" ved å trykke encoderknappen.

Ekstern kontrolladministrasjon



- ▶ Velg den ønskete RC fjernkontroll utgang (CH1, CH2, CH3, CH4) ved å trykke knapp. .
- ▶ Velg ønsket parameter (Min-Max-parameter) ved å trykke encoderknappen.
- ▶ Juster ønsket parameter (Min-Max-parameter) ved å dreie encodere.
- ▶ For å lagre endringen, trykk på: .
- ▶ Bekreft operasjonen ved å trykke knappen .

5.2.5 Kalibrering kretsmotstand (set up 705)

Tillater å kalibrere generatoren på varmelementet til den aktuelle sveisekretsen.

Valg av parameter

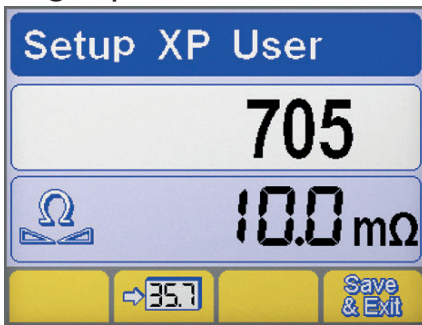

- ▶ Gå inn i oppsett ved å trykke encoderknappen i minst 5 sekunder.
- ▶ Velg det ønskete parameter (705).
- ▶ Aktiver reguleringen av det valgte parameter ved å trykke encoderknappen.
- ▶ Koble generatoren til sveisekretsen (benk eller arbeidsstykke).
- ▶ Ta av hetten for å sette på dyseholderspissen på sveisebrenneren. (MIG/MAG)

Kalibrasjon

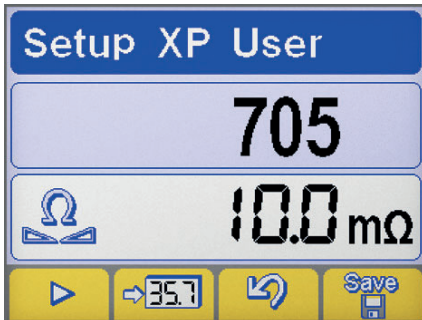

- ▶ Plasser tuppen av strådstyringen i elektrisk kontakt med arbeidsstykket. (MIG/MAG)
- ▶ Trykk på knappen ▶ for å starte prosedyren.
- ▶ Opprett kontakten i minst ett sekund.
- ▶ Verdien vist på displayet oppdateres ved avsluttet kalibrering.
- ▶ Bekreft operasjonen ved å trykke knappen .
- ▶ Bekreft operasjonen ved å trykke knappen .
- ▶ For å lagre endringen og gå ut av set up, trykk på: .

5.2.6 Vaktgrenser (Set up 801)

Muliggjør setting av varselgrenser og av vaktgrenser.

Lar sveiseprosessen bli kontrollert ved å sette varselgrenser og vaktgrenser for de målbare hoved- parameter.

Tillater nøyaktig kontroll av de forskjellige sveisefaser.



Sveisestrøm



Sveisespenning



Gassflyt lesing



Robot bevegelseshastighet



Strømvlesing (motor 1)



Strømvlesing (motor 2)



Avlesing av kjølevæskeflyt



Tråd hastighet



Kjølevæsketemperatur lesing

Valg av parameter

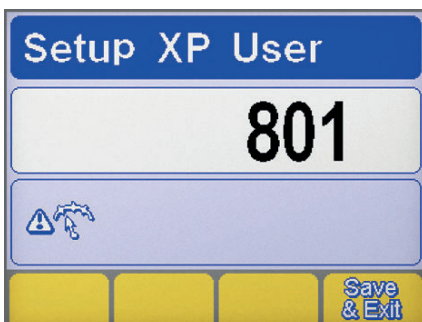

- ▶ Gå inn i oppsett ved å trykke encoderknappen i minst 5 sekunder.
- ▶ Velg det ønskete parameter (801).
- ▶ Gå inn i skjermen "Vaktgrenser" ved å trykke encoderknappen.

NO

Valg av parameteren

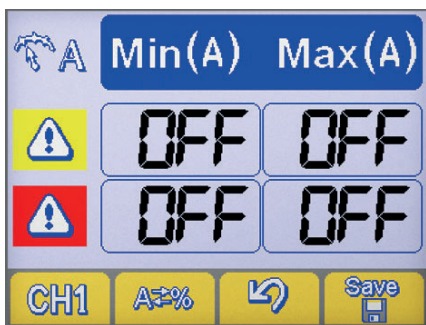

- ▶ Velg ønsket parameter ved å trykke knappen **CH1**.
- ▶ Velg metoden for setting av vaktgrenser ved å trykke knappen **A=%**.

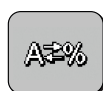

Innstilling av maskin



Absolutt verdi



Prosentverdi

Innstilling av sikkerhetstærskler

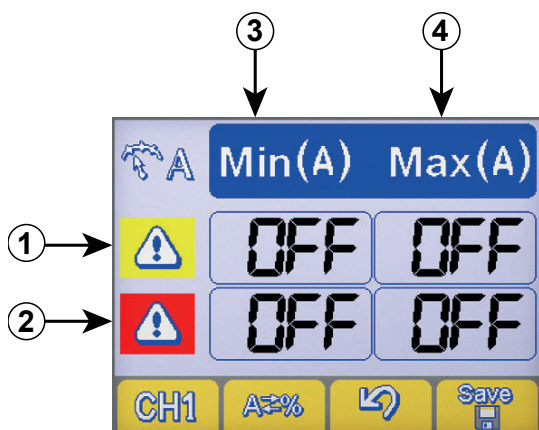

- ① Varselgrense linje
- ② Alarmgrense linje
- ③ Minimum nivå kolonne
- ④ Maksimum nivå kolonne

- ▶ Velg ønsket boks ved å trykke encoderknappen (den valgte boks vises med omvendt kontrast).
- ▶ Juster nivået på den valgte grense ved å dreie encodern.
- ▶ For å lagre endringen, trykk på: **Save**.



Passering en av varselgrensene medfører at et visuelt signal fremkommer på kontrollpanelet.



Passering en av alarmgrensene medfører at et visuelt signal fremkommer på kontrollpanelet og øyeblikkelig blokkering av sveiseoperasjonene.



Det er mulig å sette start og slutt på sveise filterne for å unngå feilsignaler under tenning og slokking av buen (konsulter seksjon "Oppsett" - Parameter 802-803-804).

6. VEDLIKEHOLD



Du må utføre rutinemessig vedlikehold på anlegget i samsvar med fabrikantens instruksjoner. Alle adgangsdører, vedlikeholdsdører og deksel må være lukket og sitte godt fast når utstyret er igang. Du skal ikke utføre endringer på anlegget. Unngå at det hopper seg opp metallstøv nær eller på selve lufteribbene.



Alt vedlikeholdsarbeid må utføres kun av kvalifisert personell. Reparasjoner eller utskifting av deler på anlegget av personell som ikke er autorisert, betyr en umiddelbar annullering av produktets garanti. Eventuelle reparasjoner eller utskiftinger av anleggets deler må kun utføres av kvalifisert teknisk personell.



Kutt strømtilførselen til anlegget før ethvert inngrep!

NO

6.1 Utfør følgende periodiske inngrep på generatoren

6.1.1 Sistem



Bruk trykkluft med lavt trykk og pensler med myk bust for rengjøring innvendig. Kontroller de elektriske koplignene og alle koplignskablene.

6.1.2 For vedlikehold eller utskifting av brennerkomponenter, av elektrodeholderens tang og/eller jordingskablene:



Kontroller komponentenes temperatur og pass på at de ikke overopphetes.



Bruk alltid vernehansker i samsvar med forskriftene.



Bruk passende nøkler og utstyr.

6.2 Sorumluluk



Hvis det ordinære vedlikeholdsarbeidet ikke blir utført, blir garantien erklært ugyldig og fabrikanten frifas for alt ansvar. Hvis operatøren ikke følger disse instruksene, frasier fabrikanten seg alt ansvar. Ikke nøl med å ta kontakt med nærmeste tekniske assistansesenter hvis du skulle være i tvil eller det skulle oppstå problemer.

7. ALARM KODER



ALARM















Utløsningen av en alarm eller overstigningen av en kritisk sikkerhetsterskel, fører til en visuell varsling på kontrollpanelet og en umiddelbar blokkering av sveisingen.



ADVARSEL













Utløsningen av en alarm eller overstigningen av en kritisk sikkerhetsterskel, fører til en visuell varsling på kontrollpanelet og en umiddelbar blokkering av sveisingen.

Nedenfor finnes en liste over anleggets alarmer og sikkerhetsgrenser.

E01	Overtemperatur		E02	Overtemperatur	
E03	Overtemperatur		E05	Overstrøm	
E06	Overstrøm effektmodul (Boost)		E07	Feil i systemet for strømtilførsel av trådtrekermotoren	
E08	Moteur bloqué		E10	Overstrøm effektmodul (Inverter)	
E11	Konfigurasjonsfeil av anlegget		E12	Kommunikasjonsfeil (WF - DSP)	
E13	Kommunikasjonsfeil		E14	Ugyldig program	
E15	Ugyldig program		E16	Kommunikasjonsfeil (RI) (Automasjon og roboter)	

 E17	Kommunikasjonsfeil (µP-DSP)		 E18	Ugyldig program	
 E19	Konfigurasjonsfeil av anlegget		 E20	Ødelagt minne	
 E21	Datatap		 E22	Kommunikasjonsfeil (DSP)	
 E29	Ikke kompatible mål		 E30	Kommunikasjonsfeil (H.F.)	
 E32	Datatap		 E38	Underspenning	
 E39	Feil i strømførsel av anlegg		 E40	Feil i strømførsel av anlegg	
 E43	Mangel på kjølevæske		 E48	Mangel på tråd (Automasjon og roboter)	
 E49	Nødstoppbryter (Automasjon og roboter)		 E50	Fastlimt tråd (Automasjon og roboter)	
 E51	Innstillinger ikke støttet (Automasjon og roboter)		 E52	Antikollisjon (Automasjon og roboter)	
 E53	Feil ekstern strømningsbryter (Automasjon og roboter)		 E54	Strømnivå oversteget (Nederste grense)	
 E55	Strømnivå oversteget (Øverste grense)		 E56	Spenningsnivå oversteget (Nederste grense)	
 E57	Spenningsnivå oversteget (Øverste grense)		 E60	Hastighetsgrense oversteget (Nederste grense)	
 E61	Hastighetsgrense oversteget (Øverste grense)		 E62	Strømnivå oversteget (Nederste grense)	
 E63	Strømnivå oversteget (Øverste grense)		 E64	Spenningsnivå oversteget (Nederste grense)	
 E65	Spenningsnivå oversteget (Øverste grense)		 E68	Hastighetsgrense oversteget (Nederste grense)	
 E69	Hastighetsgrense oversteget (Øverste grense)		 E70	Innstilte sikkerhetsteskler ikke kompatible	
 E71	Overtemperatur kjølevæske		 E72	Overstrøm push-pull motor	

NO

 Hastighetsgrense tråd oversteget (speed meter) 	 Strømnivå motor 1 oversteget 
 Strømnivå motor 2 oversteget 	 Strømningsnivå for kjølevæske oversteget 
 Temperaturnivå kjølevæske 	 Aktivt vedlikehold (Automasjon og roboter) 

8. DIAGNOSTIKK OG LØSNINGER

Anlegget kan ikke startes opp (den grønne lysindikatoren tenner ikke)

Årsak

- » Ingen nettspenning i forsyningsnettet.
- » Defekt kontakt eller elektrisk strømforsyningskabel.
- » Linjens sikring er gått.
- » Defekt av/på-bryter.
- » Forbindelsen mellom trådmatervogna og generator feil eller defekt.
- » Defekt elektronikk.

Løsning

- » Kontroller og om nødvendig reparer det elektriske anlegget.
- » Benytt kun kvalifisert personell.
- » Skift ut den skadde komponenten.
- » Henvend deg til det nærmeste senter for teknisk assistanse for å reparere anlegget.
- » Skift ut den skadde komponenten.
- » Skift ut den skadde komponenten.
- » Henvend deg til det nærmeste senter for teknisk assistanse for å reparere anlegget.
- » Kontroller at de forskjellige deler i systemet er skikkelig tilkoppelt.
- » Henvend deg til det nærmeste senter for teknisk assistanse for å reparere anlegget.

Ingen strøm ved utgangen (anlegget sveiser ikke)

Årsak

- » Defekt sveisebrennertast.
- » Overopphetet anlegg (termisk alarm - gul lysindikator lyser).
- » Sidedekslet er åpent eller dørbryteren er defekt.
- » Feil jordkopling.
- » Nettspenningen er utenfor området (den gule lysindikatoren lyser).
- » Defekt elektronikk.

Løsning

- » Skift ut den skadde komponenten.
- » Henvend deg til det nærmeste senter for teknisk assistanse for å reparere anlegget.
- » Vent til anlegget er avkjølet uten å slå fra strømmen.
- » Det er nødvendig for operatørens sikkerhet at sidedekslet er lukket under sveisefasene.
- » Skift ut den skadde komponenten.
- » Henvend deg til det nærmeste senter for teknisk assistanse for å reparere anlegget.
- » Utfør korrekt jordekopling.
- » Se avsnittet "Installasjon".
- » Tilbakestill nettspenningen innenfor generatorens arbeidsområde.
- » Utfør enkorrekt kopling av anlegget.
- » Se avsnittet "Kopling".
- » Henvend deg til det nærmeste senter for teknisk assistanse for å reparere anlegget.

Feil strømforsyning

Årsak

- » Feilt valg av prosedyren for sveising eller defekt velger.
- » Feile parameterinnstillinger og funksjoner i anlegget.

Løsning

- » Utfør et korrekt valg av prosedyren sveising.
- » Skift ut den skadde komponenten.
- » Henvend deg til det nærmeste senter for teknisk assistanse for å reparere anlegget.
- » Utfør en reset på anlegget og tilbakestill parametrene for sveising.

- » Defekt potensiometer/kodeenhet for regulering av strømmen for sveising.

- » Nettspenningen er utenfor området.

- » En fase mangler.

- » Defekt elektronikk.

- » Skift ut den skadde komponenten.
- » Henvend deg til det nærmeste senter for teknisk assistanse for å reparere anlegget.

- » Utfør enkorrekt kopling av anlegget.
- » Se avsnittet "Kopling".

- » Utfør enkorrekt kopling av anlegget.
- » Se avsnittet "Kopling".

- » Henvend deg til det nærmeste senter for teknisk assistanse for å reparere anlegget.

Blokkert fremtrekk av tråden

Årsak

- » Defekt sveisebrennertast.

- » Feile eller slitte valser.

- » Defekt trådmater.

- » Sveisebrennerens verneutstyr er skadd.

- » Trådtrekkeren er ikke forsynt med strøm.

- » Floke på spolen.

- » Sveisebrennerens dyse er smeltet (tråden er fast).

Løsning

- » Skift ut den skadde komponenten.
- » Henvend deg til det nærmeste senter for teknisk assistanse for å reparere anlegget.

- » Skift ut valsene.

- » Skift ut den skadde komponenten.
- » Henvend deg til det nærmeste senter for teknisk assistanse for å reparere anlegget.

- » Skift ut den skadde komponenten.
- » Henvend deg til det nærmeste senter for teknisk assistanse for å reparere anlegget.

- » Kontroller koplingen til generatoren.
- » Se avsnittet "Kopling".
- » Henvend deg til det nærmeste senter for teknisk assistanse for å reparere anlegget.

- » Løs opp floken på spolen eller skift den ut.

- » Skift ut den skadde komponenten.

Trådens fremtrekk er ikke regelmessig

Årsak

- » Defekt sveisebrennertast.

- » Feile eller slitte valser.

- » Defekt trådmater.

- » Sveisebrennerens verneutstyr er skadd.

- » Koplingen eller valsenes låseenheter er galt justert.

Løsning

- » Skift ut den skadde komponenten.
- » Henvend deg til det nærmeste senter for teknisk assistanse for å reparere anlegget.

- » Skift ut valsene.

- » Skift ut den skadde komponenten.
- » Henvend deg til det nærmeste senter for teknisk assistanse for å reparere anlegget.

- » Skift ut den skadde komponenten.
- » Henvend deg til det nærmeste senter for teknisk assistanse for å reparere anlegget.

- » Løsne koplingen.
- » Øk trykket på valsene.

Instabilitet i buen

Årsak

- » Utilstrekkelig dekk-gass.

- » Fuktighet i sveisegassen.

- » Gale sveiseparameterparameter.

Løsning

- » Reguler korrekt gassflyt.
- » Kontroller at diffusereren og gassmunnstykket i sveisebrenneren er i god tilstand.

- » Bruk alltid produkter eller materialer av høy kvalitet.
- » Forsikre deg om at gassforsyningsanlegget alltid er i god funksjonstilstand.

- » Utfør en nøyaktig kontroll av anlegget for sveising.
- » Henvend deg til det nærmeste senter for teknisk assistanse for å reparere anlegget.

Altfor mye sprut

Årsak	Løsning
» Gal buelengde.	» Reduser avstanden mellom elektroden og stykket.
» Gale sveiseparameterparameter.	» Reduser sveisespenningen.
» Utilstrekkelig dekk-gass.	» Reduser sveisestrømmen.
» Gal buedynamikk.	» Reguler korrekt gassflyt.
» Gal modus for utførelse av sveising.	» Kontroller at diffusereren og gassmunnstykket i sveisebrenneren er i god tilstand.
	» Øk kretsens induktive verdi.
	» Bruk et større induktivt uttak.
	» Reduser sveisebrennerens vinkel.

Utilstrekkelig hullslåing

Årsak	Løsning
» Gal modus for utførelse av sveising.	» Senk kjørehastigheten under sveising.
» Gale sveiseparameterparameter.	» Øk sveisestrømmen.
» Feil elektrode.	» Bruk en elektrode med mindre diameter.
» Gal forberedelse av kantene.	» Øk riflenes åpning.
» Feil jordkopling.	» Utfør korrekt jordekopling.
» Stykkene som skal sveises for stor.	» Se avsnittet "Installasjon".
	» Øk sveisestrømmen.

Inkludering av slag

Årsak	Løsning
» Utilstrekkelig fjerning av slag.	» Utfør en nøyaktig rengjøring av stykkene før du utfører sveisingen.
» Elektrodens diameter er altfor stor.	» Bruk en elektrode med mindre diameter.
» Gal forberedelse av kantene.	» Øk riflenes åpning.
» Gal modus for utførelse av sveising.	» Reduser avstanden mellom elektroden og stykket.
	» La fremgangen skje regelmessig under alle fasene i sveising.

Inkluderings av wolfram

Årsak	Løsning
» Gale sveiseparameterparameter.	» Reduser sveisestrømmen.
» Feil elektrode.	» Bruk en elektrode med en større diameter.
» Gal modus for utførelse av sveising.	» Bruk alltid produkter eller materialer av høy kvalitet.
	» Utfør en korrekt sliping av elektroden.
	» Unngå kontakt mellom elektroden og sveisebadet.

Blåsing

Årsak	Løsning
» Utilstrekkelig dekk-gass.	» Reguler korrekt gassflyt.
	» Kontroller at diffusereren og gassmunnstykket i sveisebrenneren er i god tilstand.

Klebing

Årsak	Løsning
» Gal buelengde.	» Øk avstanden mellom elektroden og stykket.
» Gale sveiseparameterparameter.	» Øk sveisespenningen.
» Gal modus for utførelse av sveising.	» Øk sveisestrømmen.
» Stykkene som skal sveises for stor.	» Øk sveisespenningen.
» Gal buedynamikk.	» Still sveisebrenneren mere i vinkel.
	» Øk sveisestrømmen.
	» Øk kretsens induktive verdi.
	» Bruk et større induktivt uttak.

Sidekutt

Årsak	Løsning
» Gale sveiseparameterparameter.	» Reduser sveisestrømmen. » Bruk en elektrode med mindre diameter.
» Gal buelengde.	» Reduser avstanden mellom elektroden og stykket. » Reduser sveisespenningen.
» Gal modus for utførelse av sveising.	» Senk oscillasjonshastigheten sidestilt ved påfylling. » Senk kjørehastigheten under sveising.
» Utilstrekkelig dekkgass.	» Bruk gass som er egnet til materialene som skal sveises.

Oksidering

Årsak	Løsning
» Utilstrekkelig dekkgass.	» Reguler korrekt gassflyt. » Kontroller at diffusereren og gassmunnstykket i sveisebrenneren er i god tilstand.

Porøsitet

Årsak	Løsning
» Nærvær av fett, malerfarge, rust eller skitt på stykkene som skal sveises.	» Utfør en nøyaktig rengjøring av stykkene før du utfører sveisingen.
» Nærvær av fett, malerfarge, rust eller skitt på materialene.	» Bruk alltid produkter eller materialer av høy kvalitet. » Forsikre deg om at materialene alltid er i perfekt brukstilstand.
» Der er fukt i støttematerialene.	» Bruk alltid produkter eller materialer av høy kvalitet. » Forsikre deg om at materialene alltid er i perfekt brukstilstand.
» Gal buelengde.	» Reduser avstanden mellom elektroden og stykket. » Reduser sveisespenningen.
» Fuktighet i sveisegassen.	» Bruk alltid produkter eller materialer av høy kvalitet. » Forsikre deg om at gassforsyningsanlegget alltid er i god funksjonstilstand.
» Utilstrekkelig dekkgass.	» Reguler korrekt gassflyt. » Kontroller at diffusereren og gassmunnstykket i sveisebrenneren er i god tilstand.
» Altfor hurtig overgang til fast form av sveisebadet.	» Senk kjørehastigheten under sveising. » Utfør en forvarming av stykkene som skal sveises. » Øk sveisestrømmen.

Krakelering på grunn av kulde

Årsak	Løsning
» Gale sveiseparameterparameter.	» Reduser sveisestrømmen. » Bruk en elektrode med mindre diameter.
» Nærvær av fett, malerfarge, rust eller skitt på stykkene som skal sveises.	» Utfør en nøyaktig rengjøring av stykkene før du utfører sveisingen.
» Nærvær av fett, malerfarge, rust eller skitt på materialene.	» Bruk alltid produkter eller materialer av høy kvalitet. » Forsikre deg om at materialene alltid er i perfekt brukstilstand.
» Gal modus for utførelse av sveising.	» Utfør korrekte funksjoner for den type av skjøter som skal sveises.
» Stykkene som skal sveises har ulike karakteristikker.	» Utfør smøring før du utfører sveiseprosedyren.

Krakelering på grunn av kjølighet

Årsak	Løsning
» Der er fukt i støttematerialene.	» Bruk alltid produkter eller materialer av høy kvalitet. » Forsikre deg om at materialene alltid er i perfekt brukstilstand.
» Spesiell geometri i punktet som skal sveises.	» Utfør en forvarming av stykkene som skal sveises. » Utfør en ettervarming. » Utfør korrekte funksjoner for den type av skjøter som skal sveises.

NO

9. TEORETISKE BESKRIVELSER AV SVEISING

9.1 Sveising med bekledd elektrode (MMA)

Forberedelse av kantene

For å oppnå gode sveiseresultater anbefales det å alltid arbeide på rene deler, fri for oksid, rust eller annet smuss.

Valg av elektrode

Diameteren på elektroden som skal benyttes er avhengig av materialets tykkelse, av posisjonen, av typen skjøt og klargjøring av stykket som skal sveises. Elektroder med stor diameter krever høy strøm med påfølgende høy termisk tilførsel i sveisingen.

Type bekleddning	Egenskap	Bruksområde
Rutil	Enkel å bruke	Alle posisjoner
Syre	Høy smeltehastighet	Flate
Basisk	Mekaniske egenskaper	Alle posisjoner

Valg av sveisestrøm

Sveisestrømmens område for typen elektrode som benyttes angis av produsenten på elektrodeneppakkene.

Tenning og opprettholdelse av buen

Den elektriske buen oppnås ved å gni elektrodens spiss på delen som skal sveises koblet til jordingskabelen, og når buen gnister, trekkes elektroden tilbake til normal sveiseavstand.

For å forbedre tenningen av buen kan det generelt være nyttig med en økning av strømmen i begynnelsen sett i forhold til sveisestrømmen (Hot Start). Når buen er tent begynner den midterste delen av elektroden å smelte og renner ned i form av dråper på den delen som skal sveises. Den ytre bekleddningen av elektroden forbrukes, og dette tilfører dekk-gass for sveisingen som således blir av ypperlig kvalitet. For å unngå at dråpene av smeltet materialet forårsaker at buen slokner på grunn av at elektroden kortslutter og kleber ved sveisebadet, er det veldig nyttig å øke sveisestrømmen en kort stund for å smelte kortslutningen (Arc Force). I tilfelle elektroden kleber til delen som skal sveises, anbefales det å redusere kortslutningsstrømmen til et minimum (antiklebing).

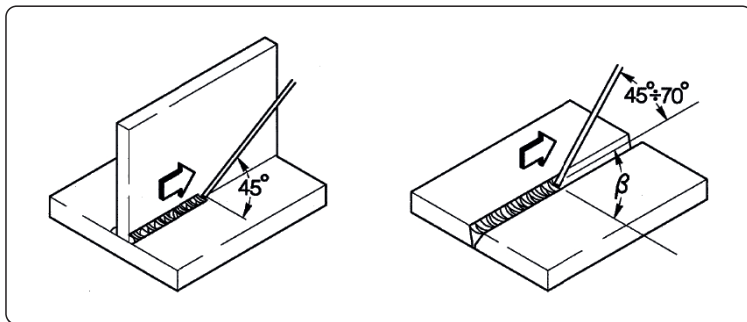

Utføring av sveising

Helningsvinkelen for elektroden varierer alt etter antallet sveisestrenger. Elektrodens bevegelse utføres normalt med oscillasjoner og med stopp på sidene av strengen slik at man unngår en opphopning av tilførselsmateriale midt på.

Fjerning av metallslag

Sveising med bekleddte elektroder gjør at man må fjerne metallslaget etter hver sveielsestreng. Fjerningen skjer ved hjelp av en liten hammer, eller slagget børstes vekk i tilfelle det dreier seg om sprøtt metallslag.

9.2 TIG-Sveising (kontinuerlig bue)

Beskrivelse

Fremgangsmåten for TIG-sveising (Tungsten Inert Gas) er basert på prinsippet av en elektrisk bue som gnistrer mellom en usmeltelig elektrode (ren wolfram eller wolframlegering, med et smeltepunkt på cirka 3370°C) og delen: En atmosfære med inert gass (argon) gjør at badet beskyttes. For å unngå farlige innblandinger av tungsten, skal elektroden aldri komme bort i den del som skal sveises. Derfor er sveise generatoren vanligvis utstyrt med en buetenningsenhet som genererer en høyfrekvent høyspennings utlader mellom elektrode og arbeidsstykket. Slik, takket være den elektriske gnisten, ioniseres gassatmosfæren, sveisebuen tenner uten noen kontakt mellom elektrode og arbeidsstykke. Det finnes også en annen måte å starte på, med redusert innblanding av wolfram: Start i lift, som ikke krever høy frekvens, men en startsituasjon med kortslutning ved lav strøm mellom elektroden og delen. I det elektroden løftes, dannes buen og strømmen øker til inntastet sveiseverdi. For å forbedre kvaliteten på sveisingens sluttdel er det viktig å kontrollere nøye den synkende sveisestrømmen og det er nødvendig at gassen kommer ned i sveisebadet i noen sekunder etter at buen slokker. I mange operative tilstander er det godt å bruke to forinnstilte sveisestrømmer slik at du lettvis kan veksle mellom de to nivåene (BINIVÅ).

Sveisepolaritet

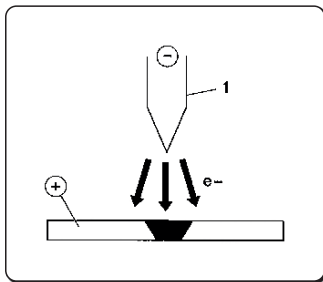

D.C.S.P. (Direct Current Straight Polarity)

Dette er den polariteten som er mest utbredt (direkte polaritet) og som gir en begrenset slitasje av elektroden (1) idet 70% av varmen konsentreres på anoden (delen).
Man oppnår trange og dype bad med høy fremføringshastighet og dermed lav termisk tilførsel.

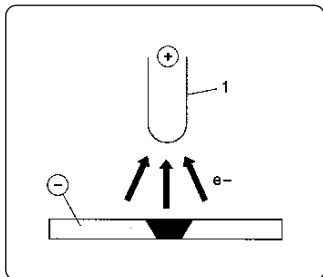

D.C.R.P. (Direct Current Reverse Polarity)

Polariteten er omvendt og gjør det mulig å sveise legeringer som er bekledd med et lag ildfast/tungtsmeltende oksid med et smeltepunkt som ligger over metalllets.
Høy strøm kan ikke benyttes da dette ville medføre stor slitasje av elektroden.

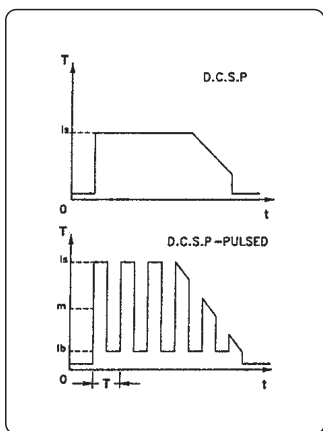

D.C.S.P.-impulser (Direct Current Straight Polarity Pulsed)

Bruk av pulst likstrøm gir en bedre kontroll, i spesielle operative situasjoner, av sveisebadets bredde og dybde.
Sveisebadet dannes av toppimpulser (Ip), mens basistrømmen (Ib) beholder buen tent. Denne operasjonsmodus hjelper ved sveising av tynnplater med mindre deformasjoner, bedre formfaktorer og medfører derfor mindre farer for overopphetning og gassgjennomslag.
Ved frekvensøkning (mellom frekvens) oppnås en smalere bue, mer konsentrert og mer stabil, og kvaliteten på sveising av tynnere materialer forbedres ytterligere.

TIG-sveising av stål

TIG-fremgangsmåten er veldig effektiv når det gjelder sveising av stål, det være seg karbonstål eller stållegeringer, for den første sveisestrengen på rør og i den typen sveisinger som må være særdeles vellykkede sett fra et estetisk synspunkt. Det kreves direkte polaritet (D.C.S.P.).

Forberedelse av kantene

Fremgangsmåten krever en grundig rengjøring av delene samt en nøye forberedelse

Valg og forberedelse av elektrode

Vi anbefaler deg å bruke elektroder av torium-tungsten (2% torium-rødfarget) eller alternativt elektroder som er vokset eller behandlet med følgende diameterverdier:

Ø elektrode	Strømområde
1.0 mm	15÷75 A
1.6 mm	60÷150 A
2.4 mm	130÷240 A

Elektroden må spisses slik som vist på figuren.

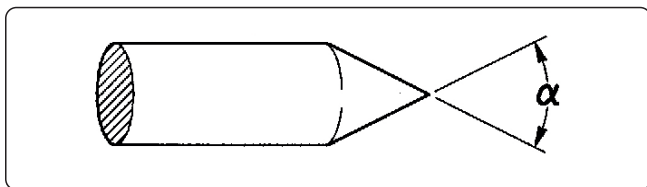

α°	Strømområde
30	0÷30 A
60÷90	30÷120 A
90÷120	120÷250 A

Tilførselsmateriale

Tilførselsstengene må ha mekaniske egenskaper som tilsvarer de som finnes i grunnmetallet.
Det frarådes å bruke strimler som er laget av grunnmetallet, idet de kan være urene grunnet bearbeidelsen og dermed ødelegge sveisearbeidet.

Dekkgass

I praksis brukes bestandig ren argon (99.99%).



Sveisestrøm	Ø elektrode	Gassdysen°	Gassdyse	Argon flyt
30 A	0÷30 mm	4/5	6/8.0 mm	5-6 l/min
60÷90 A	30÷120 mm	4/5/6	6.5/8.0/9.5 mm	6-7 l/min
90÷120 A	120÷250 mm	6/7	9.5/11.0 mm	7-8 l/min

TIG-sveising av kobber

I og med at TIG er en fremgangsmåte med svært høy termisk konsentrasjon, er TIG-sveisingen særs egnet til sveising av materialer som har en meget stor evne til å lede varme, slik som kobber.

For TIG-sveising av kobber følg samme anvisninger som for TIG-sveising av stål eller spesielle instruksjer.

9.3 Kontinuerlig trådsveising (MIG/MAG)

Introduksjon

Et MIG-system består av en likstrømsgenerator, en trådmater og en spole, en brenner og gass.

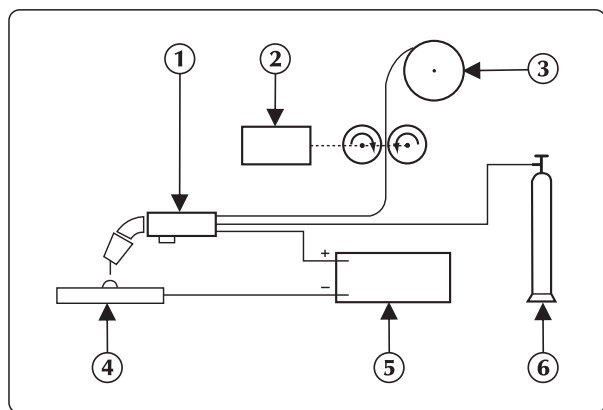

Anlegg for manuell sveising

Strømmen blir overført til buen ved hjelp av sikringselektroden (tråd tilkoplest positiv pol);

I prosedyren blir det smeltede metallet overført til den del som skal sveises, ved hjelp av buen.

Den automatiske matingen av tråden er nødvendig for å etterfylle tråden som har smeltet under sveisingen.

Fremgangsmåter

I MIG sveising er det to hovedsaklige metalloverføringsmekanismer tilstede, og de kan klassifiseres i henhold til måten metallet blir overført fra elektroden til arbeidsstykket.

Den første metoden har definisjonen "OVERGANG VED HJELP AV KORTSLUTNING (SHORT-ARC)" som produserer et lite hurtigstorknet sveisebad hvor metallet overføres fra elektroden til arbeidsstykket kun for et kort øyeblikk når elektroden er i kontakt med sveisebadet. I denne tidsrammen kommer elektroden i direkte kontakt med sveisebadet, lager en kortslutning som smelter tråden som derved avbrytes. Buen tennes igjen og syklusen repeteres.

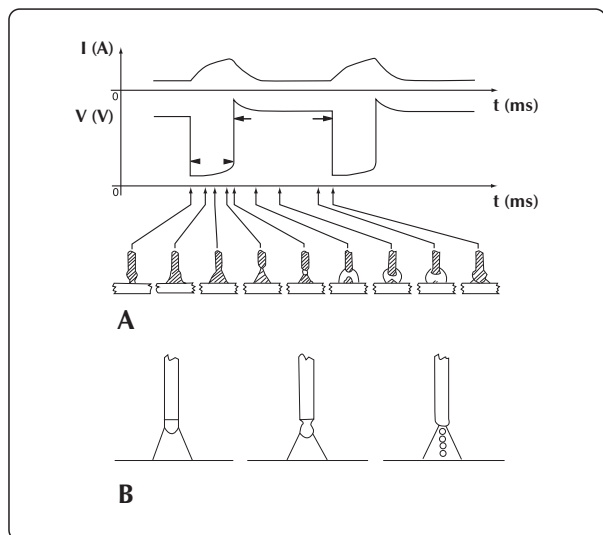

SHORT-syklus og SPRAY ARC sveising

En annen metode for å oppnå overføring av dråpene er "OVERFØRING MED SPRØYT (SPRAY-ARC)", som gjør at det dannes meget små dråper som kan løsne fra tuppen av tråden og overføres til sveisebadet gjennom buestrømmen.

NO

Sveiseparameter



Buens synbarhet minker nødvendigheten for operatøren å kontrollere nøye reguleringstabellene, da han i stedet kan kontrollere fusjonsbadet direkte.

- Spenningen påvirker resultatet direkte, men dimensjonene for sveiseoverflaten kan varieres i forhold til kravene ved at du manuelt dreier sveisebrenneren manuelt, slik at du oppnår varierte deponeringer med konstant spenning.
- Matehastigheten er proporsjonal med sveisestrømmen.

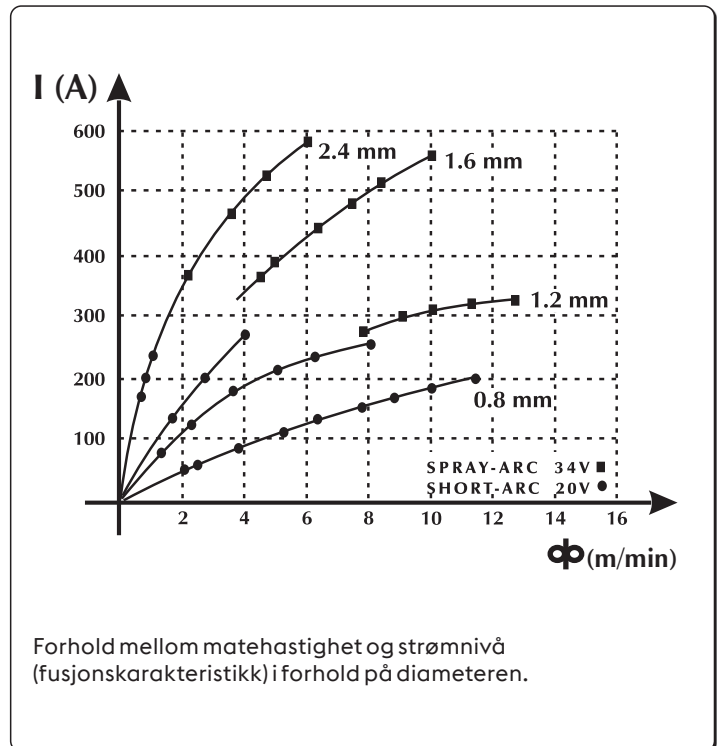
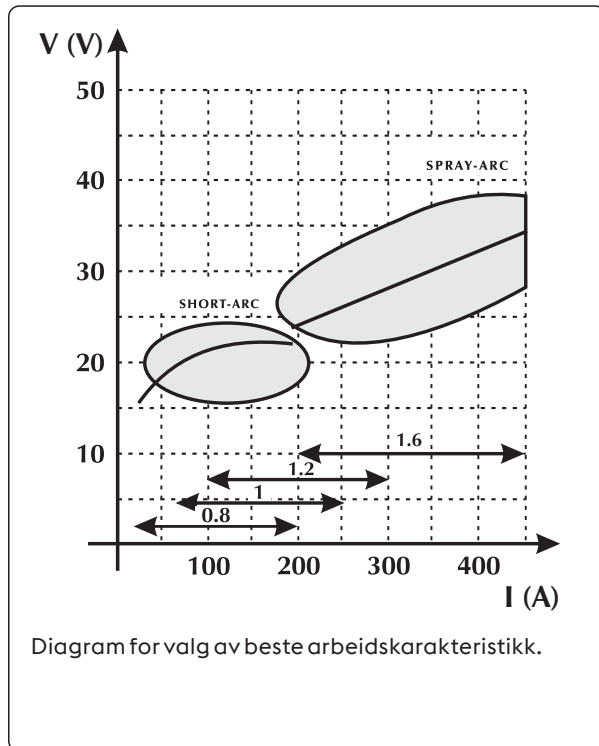
Aşağıdaki iki resimde, çeşitli kaynak parametreleri arasında var olan ilişkiler gösterilmektedir.

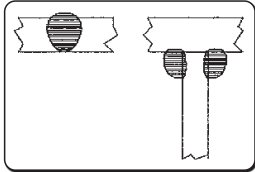
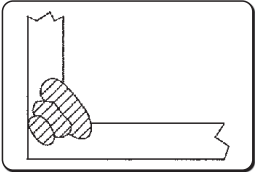
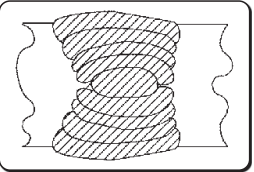

Tabell for valg av sveiseparametrene i forhold til de mest typiske applikasjonene og de mest vanlig brukte typene

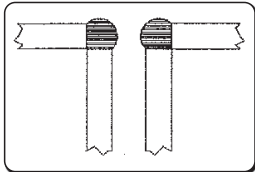
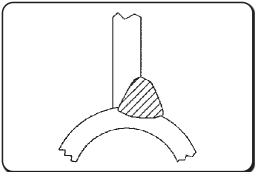
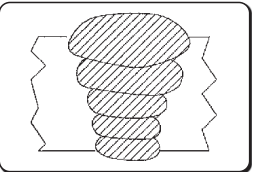
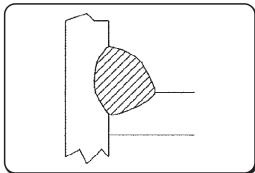
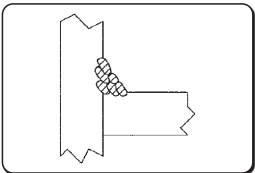
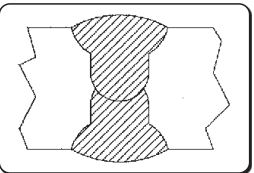
Buespenning	Ø 0,8 mm	Ø 1,0-1,2 mm	Ø 1,6 mm	Ø 2,4 mm
16V - 22V SHORT - ARC				
	60 - 160 A Lav penetrasjon for tynt materiale	100 - 175 A God kontroll av penetrasjon og fusjon	120 - 180 A God flat og vertikal smelting	150 - 200 A Ikke brukt
	<hr/>			
	24V - 28V SEMI SHORT-ARC (Overgangsområde)			
150 - 250 A Automatisk sveising i vinkel		200 - 300 A Automatisk sveising med høy spenning	250 - 350 A Automatisk sveising i skråning	300 - 400 A Ikke brukt
<hr/>				
30V - 45V SPRAY - ARC				
	150 - 250 A Lav penetrasjon med regulering til 200 A	200 - 350 A Automatisk sveising med flere turer	300 - 500 A God penetrasjon i skråning	500 - 750 A Bra penetrasjon, store deponeringer på tykke materialer

Gasser som kan bli brukt

MIG-MAG sveising er karakterisert spesielt av den type av gass som skal brukes for den, inert gass for MIG (Metal Inert Gas) sveising, aktiv gass for MAG (Metal Active Gas) sveising.

- Kulldioksid (CO₂)

Hvis du bruker CO₂ som dekk-gass, kan du oppnå høye penetrasjoner med høy matehastighet og gode mekaniske egenskaper, sammen med lave produksjonskostnader. På den andre siden, bruken av denne gassen skaper store problem i den endelige kjemiske sammensetningen i fugene, da det skjer et tap av elementer som lett oksideres og samtidig øker kvantiteten av kull i badet. Sveising med ren CO₂ skaper også andre problemer, som f.eks. altfor mye sprut og danning av porøsiteter pga kulloksyd.

- Argon

Denne inerte gassen blir brukt kun for sveising av lettere legeringer, da det ved sveising av rustfritt stål med krom/nikkel, er å anbefale å bruke argon med tillegg på 2% av oksygen og kulldioksid da dette gir en bedre stabilitet i buen og en bedre forming av sveisen.

- Helium

Denne gassen blir brukt som alternativ til argon og tillater en større penetrasjon (på tykt materiale) og en høyere matehastighet.

- Blanding argon-helium

Du oppnår en stabilere bue enn med ren helium, en større penetrasjon og høyere hastighet enn hvis du bruker argon.

- Blanding argon-kulldioksid og argon-kulldioksid-oksygen

Disse blandinger blir brukt for sveising av ferromaterialer, spesielt i modus som SHORT-ARC, da de termiske karakteristiske trekkene er meget bedre. Dette utelukker ikke bruken i SPRAY-ARC.

Normalt inneholder blandingen kulldioksid mellom 8% og 20% og oksygen rundt 5%.

Konsultør instruksjonshåndboken for systemet.

10. TEKNISK SPESIFIKASJON

Elektriske egenskaper			U.M.
Strømforsyningsspenning U1 (50/60 Hz)	3x230 (±15%)	3x400 (±15%)	Vac
Zmax (@PCC)*	62	62	mΩ
Treg linjesikring	30	20	A
Kommunikasjonsbuss	DIGITAL	DIGITAL	
Maksimal effekt absorbert	13.3	13.0	kVA
Maksimal effekt absorbert	12.8	12.4	kW
Effektforbruk i inaktiv status	71	71	W
Effektfaktor (PF)	0.96	0.95	
Yteevne (μ)	85	85	%
Cos φ	0.99	0.99	
Maksimal absorbert strøm I1max	32.9	18.8	A
Faktisk strøm I1eff	20.8	13.3	A
Reguleringsområde (MMA)	3-320	3-320	A
Tomgangsspenning Uo	75	75	Vdc

* Dette utstyr er i overensstemmelse med EN / IEC 61000-3-11.

* Dette utstyr samsvarer med EN / IEC 61000-3-12 hvis maximum tillatt nettipedanse ved grensesnittpunktet til offentlig nett (felles kopleingspunkt, pcc) er mindre eller lik "zmax" fastsatt verdi. Hvis det koples til et offentlig lavspenningssystem, er det installatørens eller utstyrets brukers ansvar, ved å konsultere operatøren av forsyningsnettverket om nødvendig, at utstyret kan tilkoples.

Bruksfaktor	3x230V	3x400V	U.M.
Bruksfaktor MMA (40°C)			
(X=35%)	320	-	A
(X=50%)	-	320	A
(X=60%)	270	300	A
(X=100%)	230	250	A
Bruksfaktor MMA (25°C)			
(X=60%)	320	320	A
(X=100%)	270	270	A
Bruksfaktor TIG (40°C)			
(X=45%)	320	-	A
(X=60%)	300	320	A
(X=100%)	250	270	A
Bruksfaktor TIG (25°C)			
(X=70%)	320	320	A
(X=100%)	270	270	A
Bruksfaktor MIG/MAG (40°C)			
(X=35%)	320	-	A
(X=50%)	-	320	A
(X=60%)	280	310	A
(X=100%)	230	250	A
Bruksfaktor MIG/MAG (25°C)			
(X=60%)	320	-	A
(X=70%)	-	320	A
(X=100%)	270	270	A

Fysiske egenskaper			U.M.
Vernegrad IP	IP23S		
Isoleringsklasse	H		
Mål (lxdxh)	620x240x460		mm
Vekt	26.7		Kg
Produksjonsnormer	EN IEC 60974-1/A1:2019 EN IEC 60974-3:2019 EN 60974-10/A1:2015		
Strømkabelseksjonen	4x4		mm ²
Lengde på nettkabel	5		m

11. IDENTIFIKASJONSPLATE

VOESTALPINE BÖHLER WELDING SELCO S.R.L. Via Palladio, 19 - ONARA (PADOVA) - ITALY			
URANOS NX 3200 PME		N°	
EN IEC 60974-1/A1:2019 60974-10/A1:2015 Class A			
3A/20.0V - 320A (320A)/32.8V (32.8V)			
X (40°C) 50% (35%) 60% 100%			
S	U ₀	I ₂	320A (320A) 300A (270A) 250A (230A)
	75V	U ₂	32.8V (32.8V) 32.0V (30.8V) 30.0V (29.2V)
3A/10.0V - 320A (320A)/22.8V (22.8V)			
X (40°C) (45%) 60% 100%			
S	U ₀	I ₂	(320A) 320A (300A) 270A (250A)
	75V	U ₂	(22.8V) 22.8V (22.0V) 20.8V (20.0V)
3A/14.0V - 320A (320A)/30.0V (30.0V)			
X (40°C) 50% (35%) 60% 100%			
S	U ₀	I ₂	320A (320A) 310A (280A) 250A (230A)
	75V	U ₂	30.0V (30.0V) 29.5V (28.5V) 26.5V (25.5V)
U ₁ 400V(230V)		I _{1max} 18.8A(32.9A)	
IP 23 S		I _{1eff} 13.3A(20.8A)	

12. BESKRIVELSE INFORMASJONSSKILT

1		2			
3		4			
5		6			
7	9	23			
		11			
8	10	12	15	16	17
		13	15A	16A	17A
		14	15B	16B	17B
7	9	11			
		12	15	16	17
8	10	13	15A	16A	17A
		14	15B	16B	17B
		18	19	20	21
22					

- 1 Produksjonsmerke
- 2 Navn og adresse til produsenten
- 3 Apparatmodell
- 4 Serienummer
X**XX**XXXXXXXXXX Produksjonsår
- 5 Symbol for type sveisemaskin
- 6 Henvisning til konstruksjonsstandarder
- 7 Symbol for sveiseprosessen
- 8 Symbol for sveisemaskiner egnet for drift i miljøer med økt risiko for elektrisk støt
- 9 Symbol for sveisestrøm
- 10 Nominell tomgangsspenning
- 11 Område for maksimal og minimum nominell sveisestrøm og tilsvarende konvensjonell belastningsspenning
- 12 Symbol for periodisk syklus
- 13 Symbol for nominell sveisestrøm
- 14 Symbol for nominell sveisespenning
- 15 Verdier for periodisk syklus
- 16 Verdier for periodisk syklus
- 17 Verdier for periodisk syklus
- 15A Verdier for nominell sveisestrøm
- 16A Verdier for nominell sveisestrøm
- 17A Verdier for nominell sveisestrøm
- 15B Verdier for konvensjonell belastningsspenning
- 16B Verdier for konvensjonell belastningsspenning
- 17B Verdier for konvensjonell belastningsspenning
- 18 Symbol for strømforsyning
- 19 Nominell forsyningsspenning
- 20 Maksimal nominell strøm
- 21 Maksimal effektiv strøm
- 22 Beskyttelsesgrad
- 23 Nominell toppspenning

CE EU-samsvarserklæring
 EAC EAC-samsvarserklæring
 UKCA UKCA-samsvarserklæring

NO

EU-VAATIMUSTENMUKAISUUSVAKUUTUS

Rakentaja

voestalpine Böhler Welding Selco S.r.l. - Via Palladio, 19 - 35019 Onara di Tombolo (PD) - ITALY
Tel. +39 049 9413/111 - Fax +39 049 9413/311 - www.voestalpine.com/welding

vakuuttaa omalla vastuullaan, että seuraava tuote:

URANOS NX 3200 PME	55.03.066
	55.03.070

on seuraavien EU-direktiivien mukainen:

2014/35/EU LOW VOLTAGE DIRECTIVE
2014/30/EU EMC DIRECTIVE
2011/65/EU RoHS DIRECTIVE

ja että seuraavia yhdenmukaistettuja standardeja on sovellettu:

EN IEC 60974-1/A1:2019	WELDING POWER SOURCE
EN 60974-10/A1:2015	ELECTROMAGNETIC COMPATIBILITY REQUIREMENTS

Asiakirjat, jotka todistavat direktiivien noudattamisen, pidetään saatavilla tarkastuksia varten edellä mainitulla valmistajalla.

Jokainen korjaus tai muutos ilman voestalpine Böhler Welding Selco S.r.l.:n antamaa lupaa tekee tästä ilmoituksesta pätemättömän.

Onara di Tombolo, 15/10/2021

voestalpine Böhler Welding Selco s.r.l.

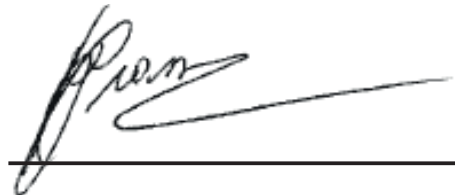

Lino Frasson

SISÄLLYS

1. VAROITUS.....	467
1.1 Työskentelytila	467
1.2 Käyttäjän ja ulkopuolisten henkilöiden suojaaminen	467
1.3 Suojautuminen höyryiltä ja kaasuilta	468
1.4 Tulipalon tai räjähdysten ehkäisy.....	468
1.5 Kaasupullojen turvallinen käyttö.....	469
1.6 Suojaus sähköiskulta	469
1.7 Sähkömagneettiset kentät ja häiriöt.....	469
1.8 IP-luokitus.....	470
1.9 Loppukäsittely	470
2. ASENNUS	471
2.1 Nosto, kuljetus ja purkaus.....	471
2.2 Laitteen sijoitus.....	471
2.3 Kytkenä.....	471
2.4 Käyttöönotto	472
3. LAITTEEN ESITTELY.....	474
3.1 Takapaneeli.....	474
3.2 Liitäntäpaneeli	474
3.3 Etuohjauspaneeli.....	474
3.4 Etuohjauspaneeli.....	475
4. LAITTEIDEN KÄYTTÖ	476
4.1 Käynnistysnäyttö.....	476
4.2 Testinäyttö.....	476
4.3 Päänäyttö	476
4.4 MMA-prosessin päänäyttö	477
5. SETUP.....	484
5.1 Set up ja parametrien säätöä	484
5.2 Parametrien erityiset käyttötoimenpiteet.....	493
6. HUOLTO	498
6.1 Suorita seuraavat määräaikaisten tarkastukset virtalähteelle	498
6.2 Rämpundere	498
7. HÄLYTYSKOODIT	498
8. VIANMÄÄRITYS JA RATKAISUT.....	500
9. HITSUKSEN TEORIAA	504
9.1 Puikkohitsaus (MMA).....	504
9.2 TIG-hitsaus (jatkuva kaari).....	504
9.3 Hitsauksesta lankaliittämällä (MIG/MAG).....	506
10. TEKNISET OMINAISUUDET	509
11. ARVOKILPI	510
12. KILVEN SISÄLTÖ.....	510
13. KYTKENTÄKAAVIO	557
14. LIITTIMET	559
15. VARAOSALUETTELO	560

SYMBOLIT



Välitön vakava hengenvaara tai vaarallinen toiminta, joka voi aiheuttaa vakavan ruumiinvamman.



Tärkeä neuvo, jota noudattamalla vältetään vähäiset vammat tai omaisuusvahingot.



Huomautukset tämän symbolin jälkeen ovat pääosin teknisiä ja helpottavat työskentelyä.

1. VAROITUS



Ennen työskentelyä laitteella, varmista että olet lukenut ja ymmärtänyt tämän käyttöohjeen sisällön.

Älä tee muutoksia tai huoltotoimenpiteitä, joita ei ole kuvattu tässä ohjeessa. Valmistajaa ei voida pitää syyllisenä henkilö- tai omaisuusvahinkoihin, jotka aiheutuvat tämän materiaalin huolimattomasta lukemisesta tai virheellisestä soveltamisesta.

Naudojimo instruksijas visada laikykite prietaiso naudojimo vietoje. Laikykitēs ne tik naudojimo instruksiju, bet ir vietoje galiojančią bendrųjų standartų ir reglamentų, susijusių su nelaimingų atsitikimų prevencija ir aplinkos apsauga.



Visi su prietaiso paleidimu, naudojimu, technine priežiūra ir remontu susiję asmenys privalo:

- turėti atitinkamą kvalifikaciją
- turėti atitinkamą suvirinimo įgūdžių
- perskaityti šias naudojimo instrukcijas ir griežtai jų laikytis

Käänny ammattitaitoisen henkilön puoleen epäselvissä tapauksissa sekä koneen käyttöön liittyvissä ongelmissa, myös sellaisissa tapauksissa, joihin näissä ohjeissa ei ole viitattu.

1.1 Työskentelytila



Kaikkia laitteita tulee käyttää ainoastaan siihen käyttöön, mihin ne on tarkoitettu, niiden arvokilvessä ja/tai tässä käyttöoppaassa olevien ohjeiden mukaisesti, noudattaen kansallisia ja kansainvälisiä turvallisuusdirektiivejä. Kaikki muu käyttö katsotaan sopimattomaksi ja vaaralliseksi, eikä valmistaja vastaa virheellisestä käytöstä johtuvista vahingoista.



Tämä laite on suunniteltu vain ammattimaiseen käyttöön teollisessa ympäristössä. Valmistaja ei vastaa vahingoista, jotka ovat aiheutuneet siitä, että laitetta on käytetty kotitaloudessa.



Laitetta tulee käyttää tiloissa, joiden lämpötila on -10°C ja +40°C välillä (+14°F... +104°F).

Laitetta tulee kuljettaa ja varastoida tiloissa, joiden lämpötila on -25°C ja +55°C välillä (-13°F... 131°F).

Laitetta ei saa käyttää tiloissa, joissa on pölyä, happeja, kaasuja tai muita syövyttäviä aineita.

Laitetta ei saa käyttää tiloissa, joiden suhteellinen kosteus on yli 50%, 40°C:ssa (104°F).

Laitetta ei saa käyttää tiloissa, joiden suhteellinen kosteus on yli 90%, 20°C:ssa (68°F).

Laitetta tulee käyttää korkeintaan 2000m (6500 jalkaa) merenpinnan yläpuolella.



Laitteistoa ei saa käyttää putkien sulattamiseen.

Laitetta ei saa käyttää akkujen ja/tai varaajien lataamiseen.

Laitetta ei saa käyttää moottorien käynnistämiseen.

1.2 Käyttäjän ja ulkopuolisten henkilöiden suojaaminen



Hitsausprosessissa muodostuu haitallisia säteily-, melu-, lämpö- ja kaasupurkauksia. Aseta palonkestävä väliseinä suojaamaan hitsausaluetta säteilystä, kipinöiltä ja hehkuvilta kuona-aineilta. Neuvo muita läheisyydessä olevia henkilöitä välttämään katsomasta hitsausta ja suojautumaan valokaaren säteilystä tai sulametallilta.



Pukeudu suojavaatteisiin suojataksesi ihosi säteilyltä, roiskeilta tai sulalta metallilta. Työvaatteiden tulee peittää koko keho ja niiden tulee olla:

- ehjät ja hyväkuntoiset
- palonkestävät
- eristävät ja kuivat
- kehonmyötäiset, ilman käänteitä



Käytä aina standardin mukaisia, kestäviä ja vedenpitäviä jalkineita.

Käytä aina standardin mukaisia, kuumalta ja sähkön aiheuttamilta vaaroilta suojaavia käsiineitä.



Käytä silmien suojana hitsausmaskia tai muuta sopivaa suojaa (vähintään NR10 tai enemmän).



Käytä aina sivusuojilla varustettuja suojalaseja, varsinkin poistettaessa hitsauskuonaa mekaanisesti tai käsin.



Älä käytä piilolinsejä!



Käytä kuulonsuojaimia jos hitsaustapahtuma aiheuttaa melun kohoamisen haitalliselle tasolle. Jos melutaso ylittää lain asettaman ylärajan, eristä työskentelyalue ja varmista että alueelle tulevat henkilöt käyttävät kuulonsuojaimia.



Sivupaneelit on pidettävä aina suljettuina hitsaustoimenpiteiden aikana. Laitteeseen ei saa tehdä minkäänlaisia muutoksia.



Sivupaneelit on pidettävä aina suljettuina hitsaustoimenpiteiden aikana. Estä käsien, hiusten, vaatteiden ja työvälineiden kosketus liikkuviin osiin, kuten: puhaltimet, hammaspyörät, rullat ja akselit, lankakelat. Älä käytä hammaspyörää langansyöttölaitteen allessa toiminnassa. Laitteeseen ei saa tehdä minkäänlaisia muutoksia. Langansyöttöyksikön suojalaitteiden poistaminen on erittäin vaarallista eikä valmistaja vastaa tästä aiheutuvista henkilö- tai esinevahingoista.



Pidä kasvot loitolla mig/mag polttimesta langan syötön ja ohjauksen ajan. Ulostuleva lanka voi aiheuttaa vakavia vammoja käsiin, kasvoihin ja silmiin.



Älä koske juuri hitsattuja kappaleita, kuumuus voi aiheuttaa vakavia palovammoja tai -haavoja. Noudata edelläkuvattuja varoimenpiteitä myös hitsauksen jälkeisissä toimenpiteissä, sillä jäähtyvistä työkappaleista saattaa irrota kuonaa.



Tarkista, että poltin on jäähtynyt ennen huolto- tai työskentelytoimenpiteiden aloittamista.



Tarkista, että jäähdytysyksikkö on sammutettu ennen kuin irrotat jäähdytysnesteen syöttö- ja takaisinvirtausletkut. Ulostuleva kuuma neste voi aiheuttaa vakavia palovammoja tai -haavoja.



Pidä ensiapupakkaus aina lähettyvillä. Älä aliarvioi palovammojen tai muiden loukkaantumisten mahdollisuutta.



Ennen kuin poistut työpaikalta, varmista työskentelyalueen turvallisuus henkilö- ja esinevahinkojen välttämiseksi.

1.3 Suojautuminen höyryiltä ja kaasuilta



Hitsauksen muodostamat savut, kaasut ja pölyt voivat olla terveydelle haitallisia. Hitsauksen aikana muodostuneet höyryt saattavat määrättyissä olosuhteissa aiheuttaa syöpää tai vahingoittaa sikiötä raskauden aikana.

- Pidä kasvot loitolla hitsauksessa muodostuneista kaasuista ja höyryistä.
- Järjestä kunnollinen ilmanvaihto, joko luonnollinen tai koneellinen, työskentelytilaan.
- Jos ilmanvaihto ei ole riittävä, on käytettävä kaasunsuodattimin varustettuja hengityksensuojaimia.
- Ahtaissa tiloissa hitsattaessa tulisi työtoverin valvoa hitsaustyötä ulkopuolelta.
- Älä käytä happea ilmanvaihtoon.
- Varmista ilmanvaihdon tehokkuus tarkistamalla säännöllisesti, ettei myrkyllisten kaasujen määrä ylitä turvallisuussäännöksissä esitettyä rajaa.
- Muodostuneiden höyryjen määrä ja vaarallisuus voidaan määrittellä käytettävän perusmateriaalin, lisäaineen, sekä hitsattavien kappaleiden puhdistukseen ja rasvanpoistoon mahdollisesti käytettyjen aineiden perusteella.
- Älä hitsaa tiloissa, joissa käytetään rasvanpoisto- tai maaliaineita.
- Sijoita kaasupullot avoimiin tiloihin tai paikkaan, jossa on hyvä ilmankierto.

1.4 Tulipalon tai räjähdysten ehkäisy



Hitsausprosessi saattaa aiheuttaa tulipalon ja/tai räjähdysten.

- Tyhjennä työalue ja ympäristö kaikesta tulenarasta tai palo-herkästä materiaalista ja esineistä.
- Helposti syttyvien materiaalien tulee olla vähintään 11 metrin (35 jalkaa) etäisyydellä hitsaustilasta, tai asianmukaisesti suojattuina.
- Kipinät ja hehkuvat hiukkaset voivat helposti sinkoutua ympäristöön myös pienistä aukoista. Varmista tarkoin henkilöiden ja esineiden turvallisuus.
- Älä hitsaa paineistettujen säiliöiden päällä tai läheisyydessä.
- Älä tee hitsaustöitä säiliössä tai putkessa. Ole erittäin tarkkana hitsatessasi putkia ja säiliöitä, myös silloin, kun ne ovat avoimia, tyhjennettyjä ja hyvin puhdistettuja. Kaasun, polttoaineen, öljyn tai muiden vastaavien aineiden jäännökset voivat aiheuttaa räjähdyksiä.
- Älä hitsaa tilassa, jonka ilmapiirissä on pölyjä, kaasuja tai räjähdysalttiita höyryjä.
- Tarkista hitsaustapahtuman päätteeksi, ettei jännitteinen piiri pääse vahingossa koskettamaan maadoituspiiriin kytkettyjä osia.
- Sijoita tulensammutusmateriaali lähelle työaluetta.

1.5 Kaasupullojen turvallinen käyttö



Suojakaasupullot sisältävät paineenalaista kaasua ja voivat räjähtää huonoissa kuljetus-, säilytys- ja käyttöolosuhteissa.

- Kaasupullot tulee kiinnittää pystyasentoon seinälle tai muuhun telineeseen, jotta ne olisivat suojattuina kaatumiselta ja mekaanisilta iskuilta.
- Suojakuvun on aina oltava suljettuna kun pulloa siirretään, kun se otetaan käyttöön ja kun hitsaustoimenpiteet ovat päättyneet.
- Suojaa kaasupullot suoralta auringonsäteilyltä, äkillisiltä lämpötilanmuutoksilta, sekä erittäin korkeilta tai alhaisilta lämpötiloilta. Älä sijoita kaasupulloja erittäin korkeisiin tai alhaisiin lämpötiloihin.
- Kaasupullot eivät saa joutua kosketuksiin liekkien, sähkökaarien, polttimien tai elektrodinpitimien, eikä hitsauksen muodostamien hehkuvien säteiden kanssa.
- Pidä kaasupullot etäällä hitsauspiiristä sekä kaikista muista virtapiireistä.
- Pidä kasvosäiliö etäällä kaasun ulostulopisteestä kaasupullon venttiiliä avattaessa.
- Sulje venttiili aina työskentelyn päättyttyä.
- Älä koskaan hitsaa paineenalaisen kaasun säiliötä.
- Älä ikinä kytke paineilmapulloa suoraan laitteen paineenalennusventtiiliin! Paine saattaa ylittää paineenalennusventtiilin kapasiteetin ja aiheuttaa räjähdysriskin!

1.6 Suojaus sähköiskulta



Sähköisku voi johtaa kuolemaan.

- Älä koske hitsausaitteen sisä- tai ulkopuolella olevia jännitteisiä osia laitteen ollessa virtalähteeseen kytkettynä (polttimet, pihdit, maadoituskaapelit, elektrodit, rullat ja kelat on kytketty sähköisesti hitsauspiiriin).
- Varmista järjestelmän ja käyttäjän sähköeristys käyttämällä kuivia tasoja ja alustoja, jotka on eristetty riittävästi maa- ja laitteen potentiaalilta.
- Varmista, että laite liitetään oikein pistokkeeseen sekä verkkoon, joka on varustettu suojavaajohtimella.
- Älä koske kahta poltinta tai hitsauspuikonpidintä samanaikaisesti.
- Jos tunnet sähköiskun, keskeytä hitsaustoimenpiteet välittömästi.

1.7 Sähkömagneettiset kentät ja häiriöt



Laitteen sisäisten ja ulkoisten kaapelien läpi kulkeva virta muodostaa sähkömagneettisen kentän hitsauskaapelien sekä itse laitteen läheisyyteen.

- Sähkömagneettiset kentät saattavat vaikuttaa sellaisten henkilöiden terveydentilaan, jotka altistuvat niille pitkäaikaisesti (vaikutusten laatua ei vielä tunneta).
- Sähkömagneettiset kentät saattavat aiheuttaa toimintahäiriöitä muihin laitteisiin, esimerkiksi sydämentahdistimeen tai kuulolaitteeseen.



Henkilöiden, joilla on sydämentahdistin, täytyy ensin keskustella lääkärin kanssa, ennen kuin voivat mennä hitsauslaitteen läheisyyteen kaarihitsauksen.

1.7.1 EMC-luokitus standardin mukaisesti: EN 60974-10/A1:2015.



Luokan B laite täyttää sähkömagneettisen yhteensopivuuden vaatimukset teollisuus- ja asuin ympäristössä, mukaan lukien asuintalot, joissa sähkönjakelu tapahtuu julkisen matalajänniteverkon kautta.



Luokan C laitetta ei ole tarkoitettu käytettäväksi asuintaloissa, joissa sähkönjakelu tapahtuu julkisen matalajänniteverkon kautta. Luokan A laitteiden sähkömagneettisen yhteensopivuuden saavuttaminen voi olla vaikeaa näissä olosuhteissa johtuvien ja säteilevien häiriöiden takia.

Katso lisätietoja luvusta: ARVOKILPI tai TEKNISET OMINAISUUDET.

1.7.2 Asennus, käyttö ja alueen tarkistus

Tämä laite on valmistettu yhdenmukaistettua standardia noudattaen EN 60974-10/A1:2015 ja on luokiteltu "A LUOKKAAN". Tämä laite on suunniteltu vain ammattimaiseen käyttöön teollisessa ympäristössä. Valmistaja ei vastaa vahingoista, jotka ovat aiheutuneet siitä, että laitetta on käytetty kotitaloudessa.



Laitteen käyttäjän tulee olla alan ammattilainen, joka on vastuussa laitteen asennuksesta ja sen käytöstä valmistajan ohjeita noudattaen. Jos jotain sähkömagneettista häiriötä on havaittavissa niin käyttäjän on ratkaistava ongelma, jos tarpeen yhdessä valmistajan teknisellä avulla.



Kaikissa tapauksissa sähkömagneettisia häiriöitä on vaimennettava niin paljon, etteivät ne enää aiheuta haittaa.



Ennen laitteen asennusta käyttäjän on arvioitava sähkömagneettiset ongelmat, jotka mahdollisesti voivat tulla esiin lähiympäristössä, keskittyen erityisesti henkilöiden terveydentilaan, esimerkiksi henkilöiden, joilla on sydäntahdistin tai kuulokoje.

1.7.3 Verkköjännitevaatimukset

Suuritehoiset laitteet saattavat, sähköverkosta otettavan ensiövirran takia, vaikuttaa verkkojännitteen laatuun. Siksi suurinta sallittua verkkoimpedanssia (Zmax) tai pienintä sallittua syötön (Ssc) kapasitanssia koskevia liitäntärajoituksia tai -vaatimuksia saattaa olla voimassa liittymässä julkiseen verkkoon (liitäntäpiste, PCC) joitakin laitetyppejä koskien (ks. tekniset tiedot). Tällöin on laitteen asentajan tai käyttäjän vastuulla varmistaa, tarvittaessa yhdessä sähköyhtiön edustajan kanssa, että laitteen kytkeminen on luvallista. Häiriötapauksissa voi olla välttämätöntä ottaa käyttöön pitemmälle meneviä turvatoimia kuten suojaerotusmuuntaja.

On myös harkittava pitääkö sähkönsyöttöjohdot suojata.

Katso lisätietoja luvusta: **TEKNISET OMINAISUUDET**.

1.7.4 Kaapeleita koskevat varoimet

Sähkömagneettisten kenttien vaikutuksen vähentämiseksi:

- Kelaa maadoituskaapeli ja voimakaapeli yhdessä ja kiinnitä mahdollisuuksien mukaan.
- Älä kela kaapeleita kehosi ympärille.
- Älä mene maadoituskaapelin ja voimakaapelin väliin (pidä molemmat samalla puolella).
- Kaapelit on pidettävä mahdollisimman lyhyinä ja lähellä toisiaan, ja niiden tulee olla maassa tai lähellä maatasoa.
- Aseta laite määrätyn välimatkan päähän hitsausalueesta.
- Kaapelit tulee sijoittaa etäälle muista mahdollisista kaapeleista.

1.7.5 Maadoitus

Hitsauslaitteiston ja sen läheisyydessä olevien metalliosien maakytkentä on varmistettava. Suojamaadoituskytkentä on tehtävä kansallisten määräysten mukaisesti.

1.7.6 Työstettävän kappaleen maadoittaminen

Mikäli työstettävää kappaletta ei ole maadoitettu sähköisten turvatoimien tai kappaleen koon tai sijainnin vuoksi, työstettävän kappaleen maadoitus saattaa vähentää sähkömagneettisia päästöjä. On tärkeää ymmärtää, että maadoitus ei saa lisätä onnettomuusrisiä eikä vahingoittaa sähköisiä laitteita. Maadoitus on tehtävä kansallisten määräysten mukaisesti.

1.7.7 Suojaus

Ympäristön muiden kaapeleiden ja laitteistojen valikoiva suojaus voi vähentää häiriöongelmia.

Koko hitsauslaitteiston suojaus voidaan ottaa huomioon erikoissovellutuksissa.

1.8 IP-luokitus



IP23S

- Kotelo on suojattu läpimitoiltaan 12,5 mm tai suurempien kiintoaineiden läpitukenkautumiselta, ja vaaralliset osat on kosketussuojattu sormilta.
- Kotelointi suojaa roiskevedeltä joka suuntautuu 60° kulmassa pystysuunnasta.
- Kotelointi suojaa sellaisia vaurioita vastaan, jotka aiheuttaa veden sisäänkäyminen laitteiston liikkuvien osien ollessa liikkeessä.

1.9 Loppukäsittely



Älä hävitä sähkölaitetta tavallisten jätteiden seassa!

Sähkö- ja elektroniikkalaiteromua koskevan eurooppalaisen direktiivin 2012/19/EU ja sen täytäntöönpaneuvien kansallisten lakien mukaisesti sähkölaitteet tulee käyttökänsä päätyttyä erilliskerätä ja toimittaa kierrätys- ja loppukäsittelykeskukseen. Laitteen omistajan tulee tiedustella valtuutetuista jätteenkeräyskeskuksista paikallisviranomaisilta. Eurooppalaisen direktiivin soveltaminen vaikuttaa myönteisesti ympäristöön ja ihmisten terveyteen.

2. ASENNUS



Ainoastaan valmistajan valtuuttama henkilöstö saa suorittaa asennuksen.



Varmista asennuksen aikana, että generaattori on irti syöttöverkosta.



Virtalähteitä ei saa kytkeä toisiinsa (sarjaan tai rinnan).

2.1 Nosto, kuljetus ja purkaus

- Laitteessa on kahva, jonka avulla sitä voidaan kuljettaa kädessä.
- Laitteessa ei ole erityisiä nosto-osia.
- Käytä haarukkanostinta, noudattaen äärimmäistä varovaisuutta, jotta generaattori ei pääse kallistumaan.



Älä koskaan aliarvioi laitteen painoa, katso kohta Tekniset ominaisuudet.

Älä koskaan kuljeta laitetta tai jätä sitä roikkumaan niin, että sen alla on ihmisiä tai esineitä.

Älä anna laitteen kaatua äläkä pudota voimalla.

2.2 Laitteen sijoitus



Noudata seuraavia sääntöjä:

- Varmista helppo pääsy laitteen säätöihin ja liitäntöihin.
- Älä sijoita laitetta ahtaaseen paikkaan.
- Älä aseta laitetta vaakasuoralle tasolle tai tasolle, jonka kaltevuus on yli 10°.
- Kytke laitteisto kuivaan ja puhtaaseen tilaan, jossa on sopiva ilmastointi.
- Suojaa kone sateelta ja auringolta.

2.3 Kytkentä



Generaattorissa on syöttökaapeli verkkoon liitääntää varten.

Laitteen virransyöttö voi olla:

- 400V kolmivaiheinen
- 230V kolmivaiheinen

Laitteiston toiminta taataan jännitteille, jotka sijoittuvat $\pm 15\%$ nimellisarvosta; (esim.: Vnom 400V työskentelyjännite on 320V - 440V).



Ihmis- ja laitevahingoilta säästymiseksi on hyvä tarkastaa valitun verkon jännite ja sulakkeet ENNEN laitteen liittämistä verkkoon. Lisäksi tulee varmistaa, että kaapeli liitetään maadoitettuun pistorasiaan.



Laitteen virransyöttö voidaan suorittaa generaattorikoneikolla, mikäli se takaa stabiilin syöttöjännitteen $\pm 15\%$ valmistajan ilmoittamaan nimellisjännitteeseen nähden, kaikissa mahdollisissa toimintaolosuhteissa ja generaattorista saatavalla Maksimiteholla. Yleensä suositellaan käytettäväksi generaattorikoneikkoja, joiden teho on yksivaiheisessa 2 kertaa suurempi kuin generaattorin teho ja 1.5 kertaa suurempi kolmivaiheisessa. On suositeltavaa käyttää elektronisesti säädettyjä generaattorikoneikkoja.



Käyttäjien suojelemiseksi laite on maadoitettava kunnolla. Syöttökaapeli on varustettu johtimella (kelta-vihreä) maadoitusta varten, joka on liitettävä maadoitettuun pistorasiaan. Tätä kelta/vihreää johdinta ei saa KOSKAAN käyttää yhdessä muiden jännitejohdattimien kanssa. Varmista laitteen maadoitus ja pistokkeiden kunto. Käytä ainoastaan pistokkeita, jotka täyttävät turvallisuus-määräykset.



Sähköasennusten pitää olla ammatillisesti pätevän sähköasentajan tekemiä ja voimassa olevien määräysten mukaisia.

2.4 Käyttöönotto

2.4.1 Kytkennät puikkohitsaukseen (MMA)



Liittäminen kuvan mukaan antaa tulokseksi vastaanapaisuudella tapahtuvan hitsauksen. Jotta voidaan hitsata negatiivisilla navoilla, on tarpeen tehdä kytkentä käänteisesti.

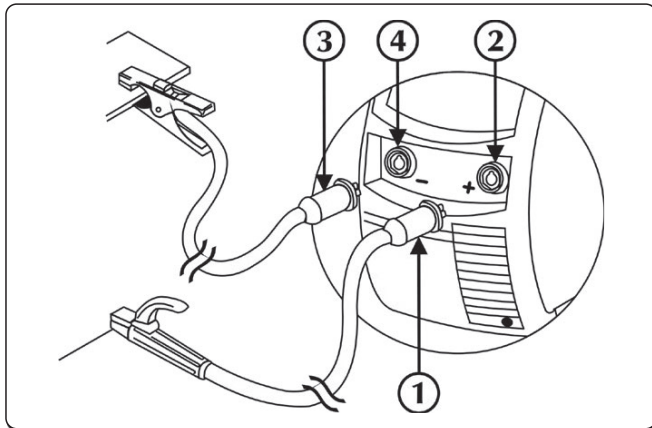

- ① Maadoitusliitin
- ② Negatiivinen liitântä (-)
- ③ Elektrodipidikkeen liitin
- ④ Positiivinen liitântä (+)

- ▶ Kiinnitä maadoituskiinnikkeen liitin virtalähteen miinusnapaan (-). Kytke pistoke ja kierrä myötäpäivään, kunnes osat ovat kokonaan kiinni.
- ▶ Kiinnitä elektrodipuikkopihdin liitin virtalähteen plusnapaan (+). Kytke pistoke ja kierrä myötäpäivään, kunnes osat ovat kokonaan kiinni.

2.4.2 Kytkennät TIG-hitsaukseen

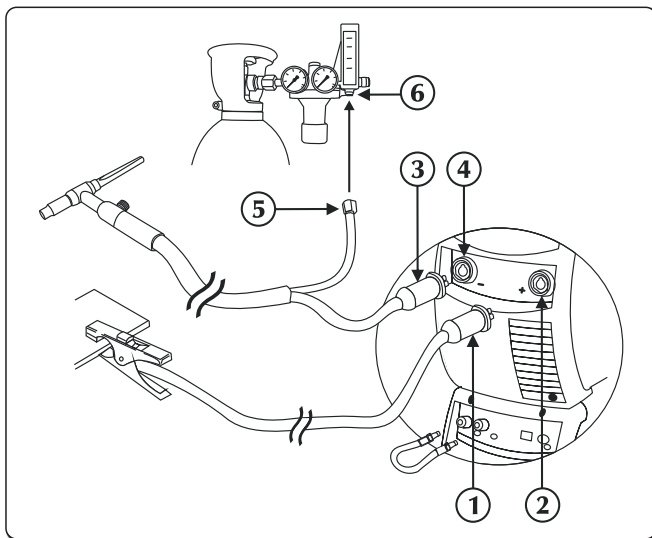



- ① Maadoitusliitin
- ② Positiivinen liitântä (+)
- ③ TIG-polttimen liitântä
- ④ Taskulamppu
- ⑤ Kaasuputken liitin
- ⑥ Paineenalentimeen

- ▶ Kiinnitä maadoituskiinnikkeen liitin virtalähteen plusnapaan (+). Kytke pistoke ja kierrä myötäpäivään, kunnes osat ovat kokonaan kiinni.
- ▶ Kiinnitä TIG-polttimen liitin virtalähteen poltinliittimeen. Kytke pistoke ja kierrä myötäpäivään, kunnes osat ovat kokonaan kiinni.





Suojakaasun virtausta säädetään yleensä polttimessa sijaitsevalla säätimellä.

- ▶ Kiinnitä erikseen kaasuhitsauspolttimen letkun liitinkappale kaasunjakeluun (7).
- ▶ Kiinnitä polttimen jäähdytysaineen takaisinvirtausletku (punainen) liitântään/kytkentään (punainen - symboli ).
- ▶ Kiinnitä polttimen jäähdytysaineen syöttöletku (sininen) liitântään/kytkentään (sininen - symboli .

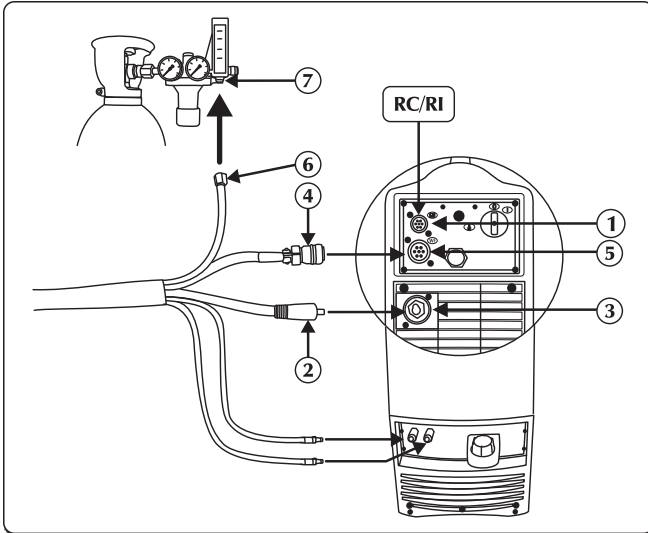
2.4.3 Liitäntä MIG/MAG hitsausta varten



- ① Signaaliikaapelin (CAN-BUS) tuloliitäntä
- ② Virtajohto
- ③ Positiivinen liitäntä (+)
- ④ Signaaliikaapeli
- ⑤ Signaaliikaapelin tulo (CAN-BUS) (kaapelinippu)
- ⑥ Kaasuputki
- ⑦ Kaasun syöttöliitin

- ▶ Liitä johdinsarjan voimakaapeli pistorasiaan. Kytke pistoke ja kierrä myötäpäivään, kunnes osat ovat kokonaan kiinni.
- ▶ Liitä johdinsarjan merkinantokaapeli liittimeen. Työnnä liitin paikoilleen ja kierrä rengasmutteria myötäpäivään, kunnes liitos on tiukalla.
- ▶ Kiinnitä johdinsarjan kaasuletku kaasupullon paineenalennusventtiiliin tai kaasun syöttöliitokseen. Säättele kaasuvirtausta nostamalla se määräst 10 l/min määrään 30 l/min.
- ▶ Kiinnitä johdinsarjan jäähdytysaineen syöttöletku (sininen) liitäntään/kytkentään (sininen - symboli ) .
- ▶ Kiinnitä johdinsarjan jäähdytysaineen takaisinvirtausletku (punainen) liitäntään/kytkentään (punainen - symboli ) .

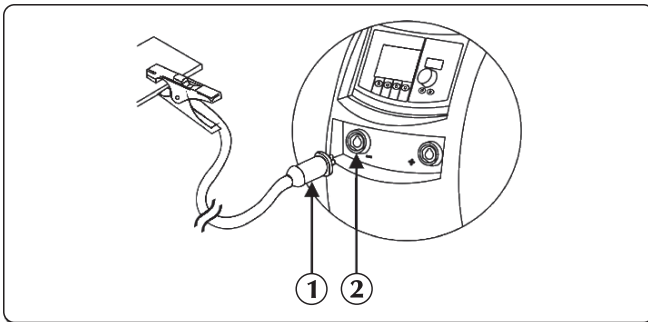

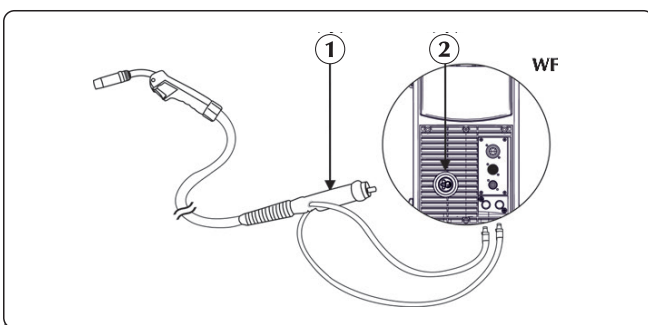

- ① Maadoitusliitin
- ② Negatiivinen liitäntä (-)

- ▶ Kiinnitä maadoituskiinnikkeen liitin virtalähteen miinusnapaan (-). Kytke pistoke ja kierrä myötäpäivään, kunnes osat ovat kokonaan kiinni.



- ① Polttimen liitäntä
- ② Liittim

- ▶ Kiinnitä polttimen jäähdytysaineen syöttöletku (sininen) liitäntään/kytkentään (sininen - symboli ) .
- ▶ Kiinnitä polttimen jäähdytysaineen takaisinvirtausletku (punainen) liitäntään/kytkentään (punainen - symboli ) .
- ▶ Kytke MIG/MAG-poltin liittimeen, huolehtien kiinnitysrenkaan kiertämisestä tiukasti kiinni;

3. LAITTEEN ESITTELY

3.1 Takapaneeli

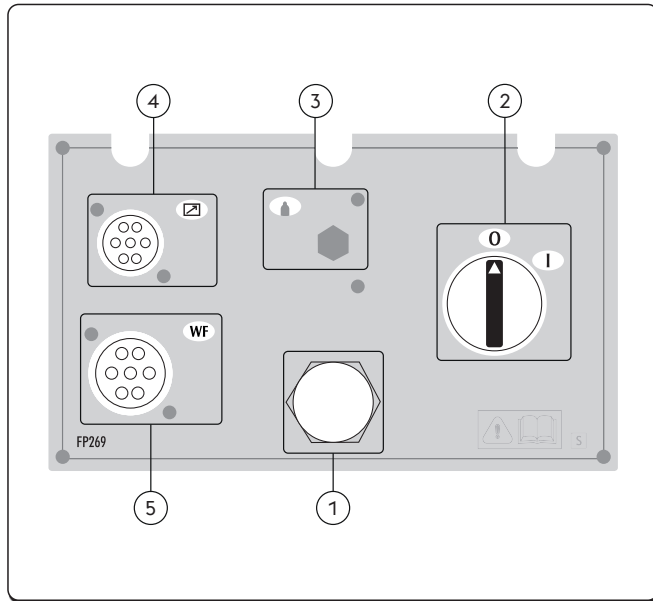

① Syöttökaapeli

Syöttökaapelin avulla laite liitetään sähköverkkoon virransyöttöä varten.

② Pääkytkin

Kytkee verkkovirran hitsauskoneeseen.

Kytkimessä on kaksi asentoa, "O" pois kytketty ja "I" päälle kytketty.

③ Ei käytetty

④ Signaalikaapelin CAN-BUS tuloliitäntä (RC, RI...)

⑤ Signaalikaapelin tulo (CAN-BUS) (kaapelinippu)

3.2 Liitäntäpaneeli

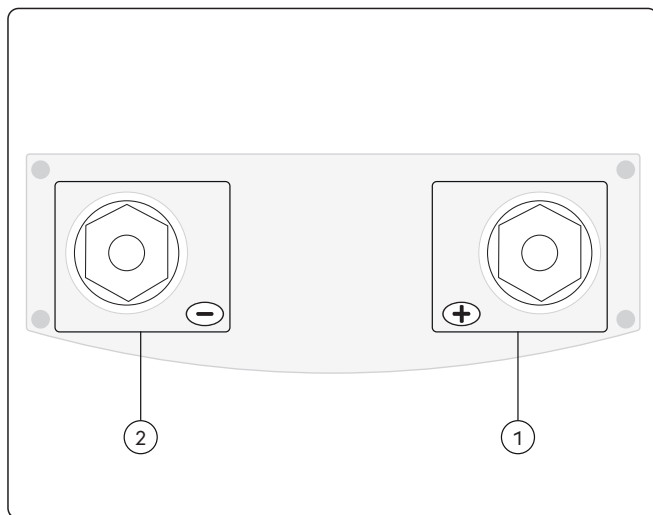

① Positiivinen liitäntä (+)

Prosessin MMA:

Elektrodipoltin liitäntä

Prosessin TIG:

Maadoituskaapelin liitäntä

② Negatiivinen liitäntä (-)

Prosessin MMA:

Maadoituskaapelin liitäntä

Prosessin TIG:

Soihtu liitäntä

MIG/MAG-prosessi:

Maadoituskaapelin liitäntä

3.3 Etuohjauspaneeli

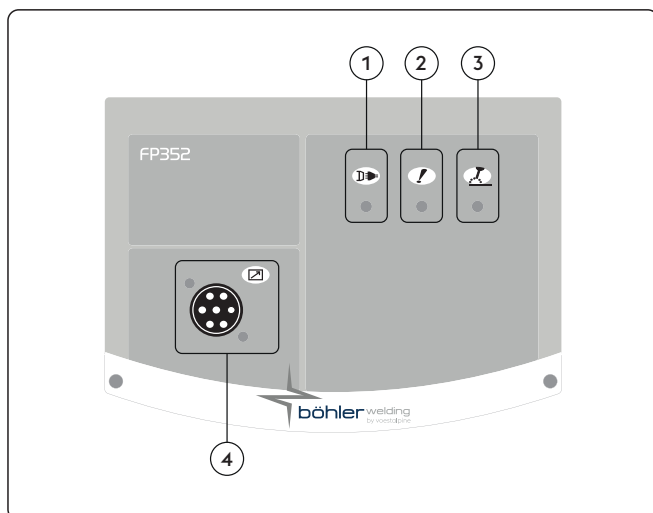

① Virran merkkivalo

Ilmaisee, että laite on kytketty verkkojännitteeseen ja jännite on päällä.

② Yleishälytyksen merkkivalo

Ilmaisee mahdollisen suojalaitteiden laukeamisen, esimerkkinä lämpösuoja.





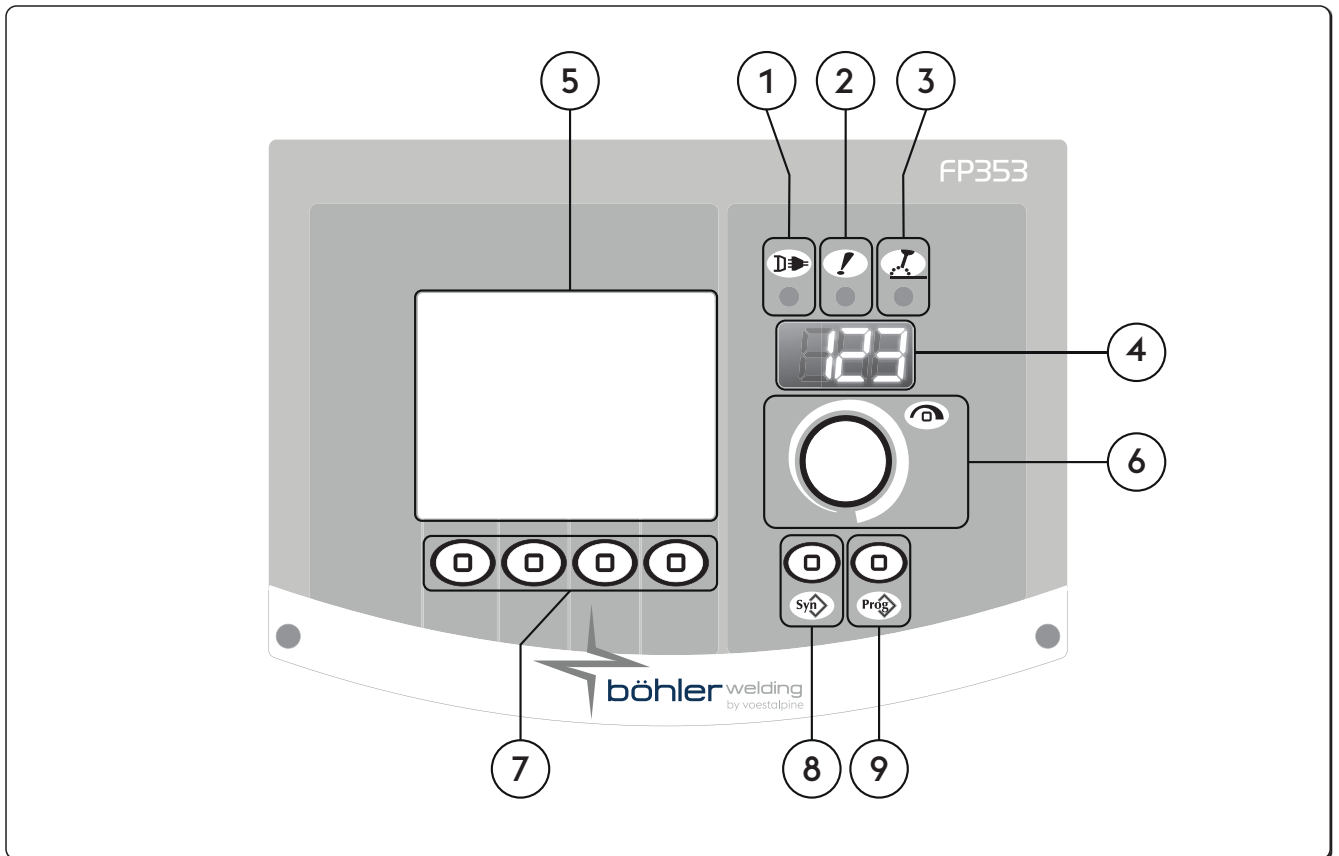

③ Aktiivisen tehon merkkivalo

Ilmaisee jännitteen olemassaolon laitteen lähtöliitännöissä.

④ Signaalikaapelin CAN-BUS tuloliitäntä (RC, RI...)

3.4 Etuohjauspaneeli



- 1  **Virran merkkivalo**
Ilmaisee, että laite on kytketty verkkojännitteeseen ja jännite on päällä.
- 2  **Yleishälytyksen merkkivalo**
Ilmaisee mahdollisen suojalaitteiden laukeamisen, esimerkkinä lämpösuoja.
- 3  **Aktiivisen tehon merkkivalo**
Ilmaisee jännitteen olemassaolon laitteen lähtöliitännöissä.
- 4  **7-segmenttinäyttö**
Mahdollistaa hitsauskoneen parametrien näytön käynnistyksen aikana, asetusten, virta- ja jännitelukemien näytön hitsauksen aikana sekä hälytysten ilmaisen.
- 5  **LCD-näyttö**
Mahdollistaa hitsauskoneen parametrien näytön käynnistyksen aikana, asetusten, virta- ja jännitelukemien näytön hitsauksen aikana sekä hälytysten ilmaisen.
Mahdollistaa toimintojen välittömän näytön.
- 6  **Pääsäätvipu**
Mahdollistaa pääsyn asetustilaan hitsausparametrien valintaa ja asettamista varten.
- 7  **Toimintonäppäimet**
Mahdollistaa eri järjestelmätoimintojen valinnan:
- Hitsausprosessi
- Hitsausmenetelmät
- Virran pulssitus
- Graafinen tila

8 Syn Ohjelmanäppäin

Mahdollistaa esiasetetun hitsausohjelman valinnan valitsemalla muutamia yksinkertaisia asetuksia:

- Langan tyyppi
- Kaasun tyyppi
- Langan halkaisija

9 Prog Työohjelman näppäin

Mahdollistaa 240 hitsausohjelman tallennuksen ja hallinnan. Käyttäjä voi mukauttaa ohjelmia tarpeen mukaan.

4. LAITTEIDEN KÄYTTÖ

4.1 Käynnistysnäyttö

Kun virta kytketään, generaattori suorittaa itsetestausjakson järjestelmän ja kytkettyjen laitteiden oikean toiminnan varmistamiseksi. Tässä vaiheessa suoritetaan myös kaasutesti kaasunsyötön oikean toiminnan tarkastamiseksi.

4.2 Testinäyttö

Hitsaustoiminnot on estetty, kun sivupaneeli (kelaosasto) on auki. LCD-näytölle tulee testinäyttö.

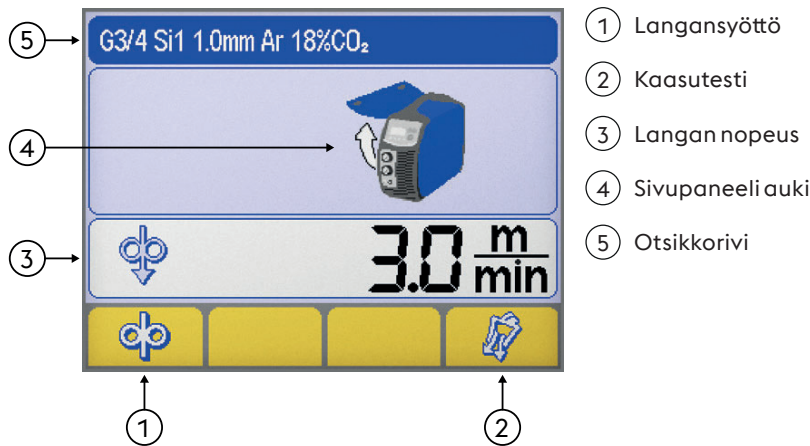

Langansyöttö

Mahdollistaa langan käsisyötön ilman kaasua ja virtaa langassa. Mahdollistaa langan asettamisen poltinrunkoon hitsauksen valmisteluvaiheissa.

Kaasutesti

Mahdollistaa kaasupiirin tyhjentämisen epäpuhtauksista sekä kaasun paineen ja virtauksen esisäädön hitsaustehoa kytkemättä.

Langan nopeus

Mahdollistaa langan syöttönopeuden säädön (kuormauksen aikana vaiheen).

Minimi	Maksimi	Oletus
0.5 m/min	22.0 m/min	3.0 m/min

Sivupaneeli auki

Otsikkorivi

Mahdollistaa tiettyjen tärkeiden tietojen näytön valitusta prosessista.

4.3 Päänäyttö

Mahdollistaa järjestelmän ja hitsausprosessin säädön, ja näyttää tärkeimmät asetukset.

4.4 MMA-prosessin päänäyttö

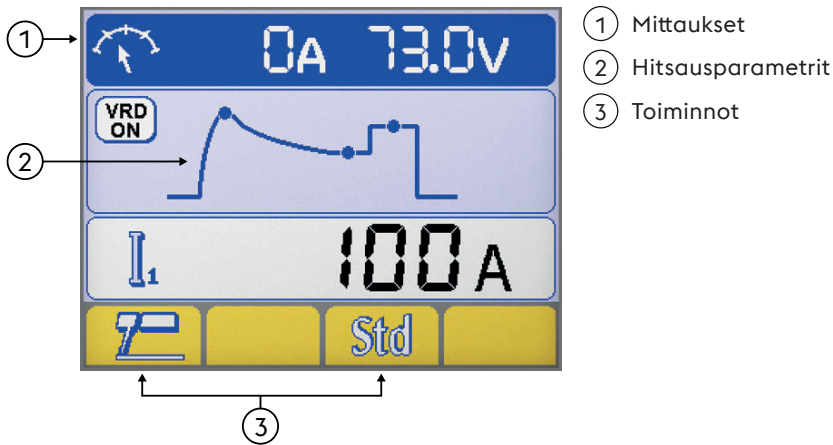

- ① Mittaukset
- ② Hitsausparametrit
- ③ Toiminnot

Mittaukset

Hitsauksen aikana virran ja jännitteen todelliset mittausarvot voidaan lukea LCD-näytöltä.

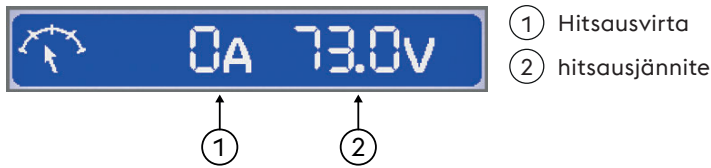

- ① Hitsausvirta
- ② hitsausjännite

Hitsausparametrit

► Valitse haluttu parametri painamalla säätönupin painiketta.

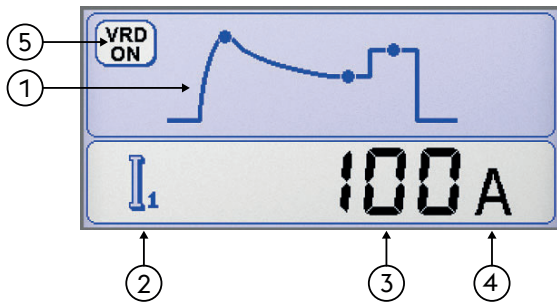

- ① Hitsausparametrit
- ② Parametrin kuvake
- ③ Parametrin arvo
- ④ Parametrin mittayksikkö
- ⑤ VRD (Voltage Reduction Device)
Jänniteen alennin
Näyttää, että laitteen tyhjäkäyntijännitettä säädetään.

Toiminnot

Mahdollistaa prosessin tärkeimpien toimintojen ja hitsausmenetelmien asettamisen.

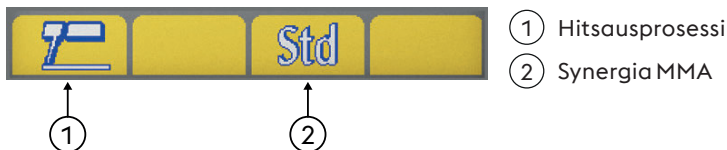

- ① Hitsausprosessi
- ② Synergia MMA





Synergia MMA

Voidaan asettaa paras valokaaren dynamiikka valitsemalla elektrodityyppi.

Kaaren oikean dynamiikan valinta mahdollistaa Maksimihödyn saamisen laitoksen potentiaalista parhaan mahdollisen hitsaustehon saavuttamiseksi.



Täydellistä hitsattavuutta käytettävällä elektrodilla ei voida taata.

Hitsattavuus riippuu tarvikkeiden laadusta ja niiden säilytyksestä, käyttö- ja hitsausolosuhteista, useista mahdollisista käyttökohteista jne.

4.5 TIG -prosessin päänäyttö



Mittaukset

Hitsauksen aikana virran ja jännitteen todelliset mittausarvot voidaan lukea LCD-näytöltä.

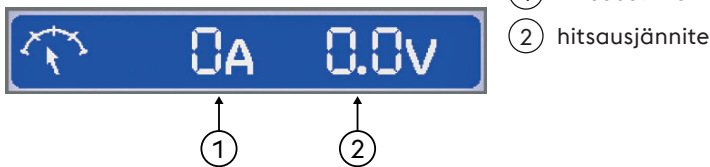

Hitsausparametrit

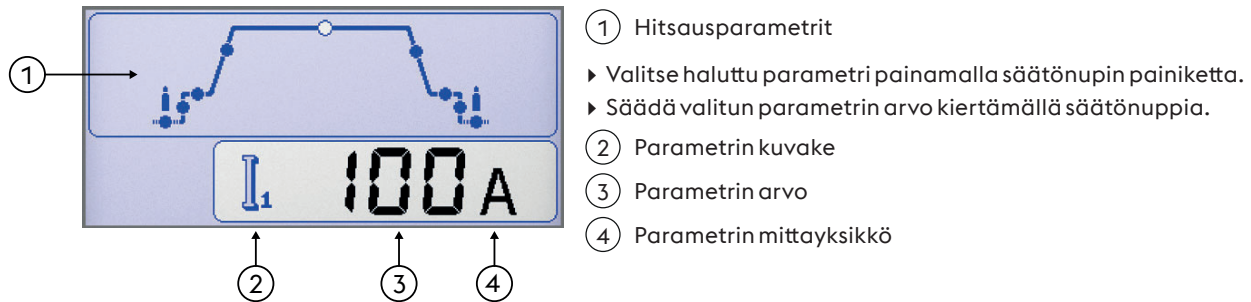

Toiminnot

Mahdollistaa prosessin tärkeimpien toimintojen ja hitsausmenetelmien asettamisen.

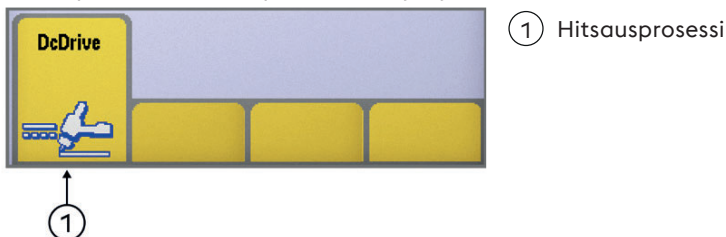

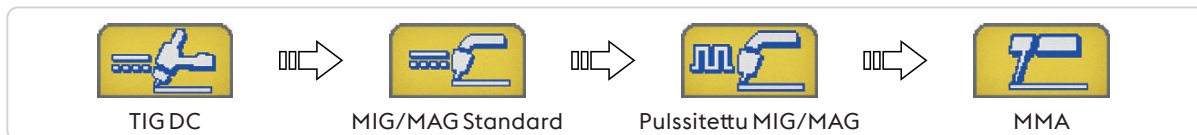
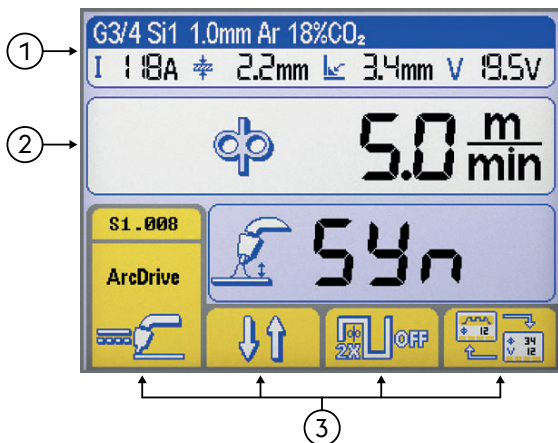
Hitsausprosessi

4.6 MIG/MAG -prosessin päänäyttö
Perusnäyttö

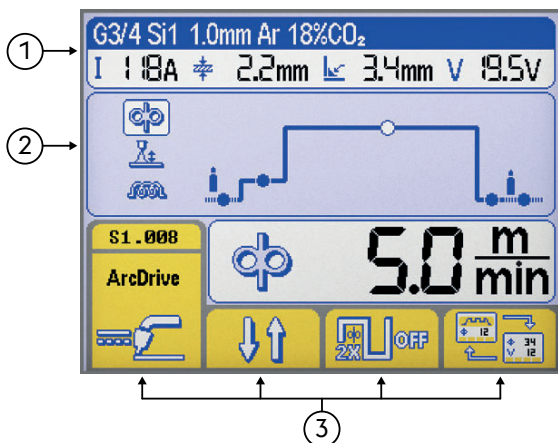
- ① Otsikkorivi MIG/MAG-prosessi
- ② Hitsausparametrit
- ③ Toiminnot

Graafinen näyttö

- ① Otsikkorivi MIG/MAG-prosessi
- ② Hitsausparametrit
- ③ Toiminnot

Otsikkorivi MIG/MAG-prosessi

Mahdollistaa tiettyjen tärkeiden tietojen näytön valitusta prosessista.



- ① Täyteaineen tyyppi
- ② Langan halkaisija
- ③ Kaasun tyyppi

Valittu synergiakäyrä

- ① Täyteaineen tyyppi
- ② Langan halkaisija
- ③ Kaasun tyyppi



- ① Hitsausvirta
- ② Kappaleen paksuus
- ③ Kulmapalko
- ④ hitsausjännite

Hitsausparametrit

- ① Hitsausvirta
- ② Kappaleen paksuus
- ③ Kulmapalko
- ④ hitsausjännite

Hitsausparametrit (Perusnäyttö)

► Valitse haluttu parametri painamalla säätönupin painiketta.

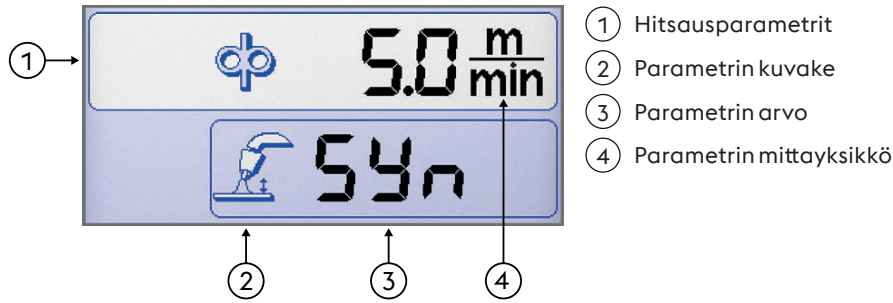

Hitsausparametrit (Graafinen näyttö)

► Valitse haluttu parametri painamalla säätönupin painiketta.

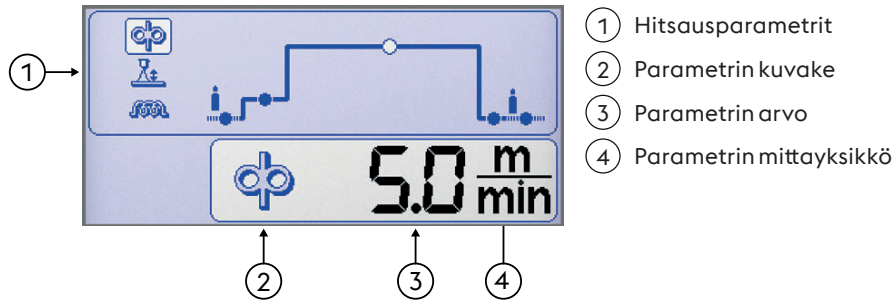

Toiminnot

Mahdollistaa prosessin tärkeimpien toimintojen ja hitsausmenetelmien asettamisen.

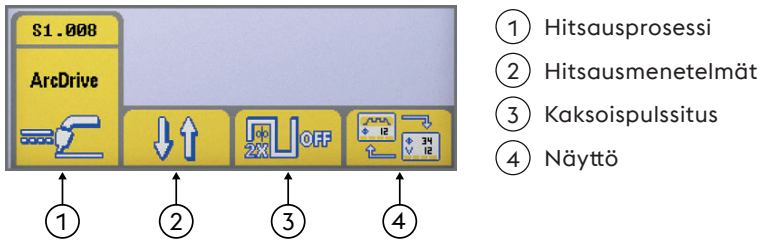

Hitsausprosessi



Hitsausmenetelmät

Mahdollistaa hitsausmenetelmän valinnan



2 vaihetta

Kahdessa vaiheessa painikkeen painaminen käynnistää kaasuvirtauksen, kytkee jännitteen lankaan ja käynnistää langansyötön; vapauttaessa painike kaasu, jännite ja langansyöttö katkeavat.



4 vaihetta

Neljässä vaiheessa painikkeen ensimmäinen painallus käynnistää kaasuvirtauksen, jolloin annetaan manuaalinen esikaasu; painikkeen vapauttaminen kytkee jännitteen lankaan ja käynnistää langansyötön. Seuraava painallus pysäyttää langansyötön ja käynnistää lopetusprosessin, jolloin virta palautuu nollaan; painikkeen vapauttaminen katkaisee lopuksi kaasuvirtauksen.



Crater filler

Mahdollistaa hitsaamisen kolmella eri tehotasolla, jotka hitsaaja voi valita ja säätää suoraan polttimen painikkeesta.

Painikkeen ensimmäinen painallus käynnistää kaasuvirtauksen, kytkee jännitteen lankaan ja syöttää lankaa "alkunopeus"-parametrilla (alkuasetuksissa) ja suhteellisilla synergiaparametreilla asetettulla nopeudella.

Kun polttimen painike vapautetaan, langan nopeus ja suhteelliset synergiaparametrit vaihtuvat automaattisesti ohjauspaneelisti asetettuihin pääarvoihin.

Seuraava polttimen painikkeen painallus asettaa langan nopeuden ja suhteelliset synergiaparametrit esiasetettuihin (alkuasetuksissa) kraatterintäytön parametriarvoihin.

Polttimen painikkeen vapauttaminen pysäyttää langansyötön ja antaa virtaa takaisinpoltto- ja jälkikaasuvaiheisiin.



Kaksoispulssitus



Kaksoispulssitus päällä



Kaksoispulssitus ei päällä

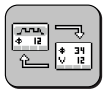

Näyttö

Mahdollistaa näytön vaihdon seuraavasti:



Perusnäyttö



Graafinen näyttö

Synergiakäyrien näyttö



Synergia

Mahdollistaa esiasetetun hitsausohjelman valinnan (synergia) valitsemalla muutamia yksinkertaisia asetuksia

Hitsausprosessin valinta

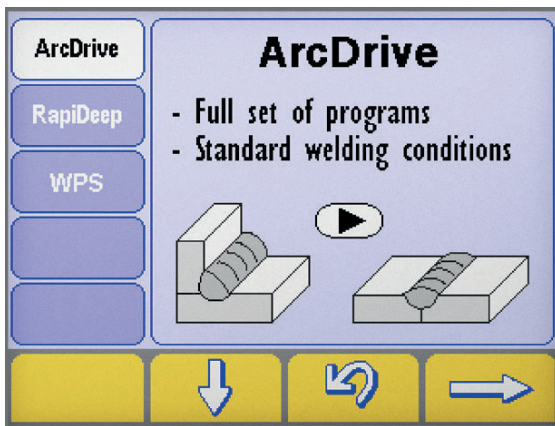

► Avaa Synergiat-näyttö painamalla näppäintä vähintään sekunnin ajan.

► Valitse haluttu prosessi painamalla näppäimiä e .

► Paina painiketta siirtyäksesi seuraavaan vaiheeseen.



Materiaalityypin/kaasutyyppin synergian valintanäyttö

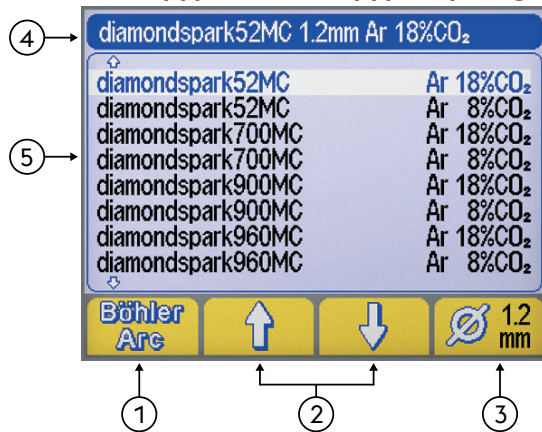

① Hitsausohjelman (BöhlerArc/UniversalArc)

② Materiaalin/kaasun valinta

③ Langan halkaisija

④ Otsikkorivi

⑤ Hitsausohjelman



Hitsausohjelman

Mahdollistaa hitsausohjelman valinnan



BöhlerArc



UniversalArc



Materiaalin/kaasun valinta

Mahdollistaa valinnan:



• Täyteaineen tyyppi

• Kaasun tyyppi





Langan halkaisija

Mahdollistaa käytettävän langan halkaisijan (mm) valinnan.

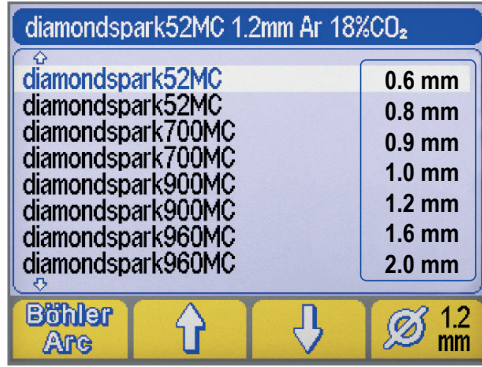

① Langan halkaisija

①



Otsikkorivi

Mahdollistaa tiettyjen tärkeiden tietojen näytön valitusta prosessista.



EI OHJELMAA

Ilmaisee, että valittua synergiaohjelmaa ei ole saatavana tai se ei ole yhdenmukainen järjestelmän muiden asetusten kanssa.

4.7 Ohjelmanäyttö



Mahdollistaa 240 hitsausohjelman tallennuksen ja hallinnan. Käyttäjä voi mukauttaa ohjelmia tarpeen mukaan.

Ohjelmat (JOB)

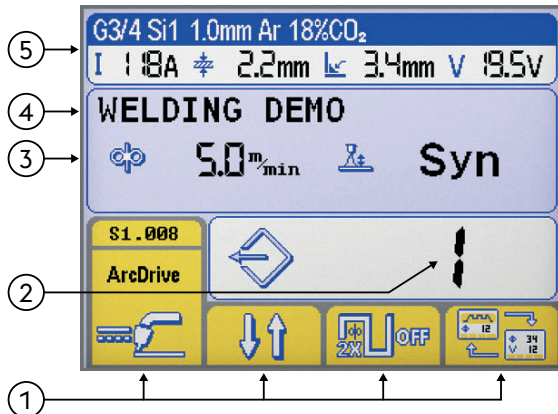

- ① Toiminnot
- ② Valitun parametrin numero
- ③ Valitun ohjelman pääparametrit
- ④ Valitun ohjelman kuvaus
- ⑤ Otsikkorivi

Katso kappale "Päänäyttö"

Ohjelman tallennus

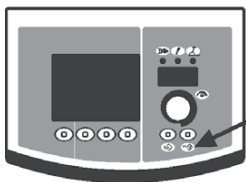

- ▶ Siirry ohjelman tallennusvalikkoon ("program storage") painamalla painiketta. vähintään sekunnin ajan.



- ▶ Valitse haluttu ohjelma (tai tyhjä muistipaikka) kiertämällä säätönuppia.

--- Muisti tyhjä



Ohjelma tallennettu

- ▶ Vahvista toiminto painamalla painiketta .

- ▶ Tallenna valitun ohjelman kaikki nykyiset asetukset painamalla painiketta. .





Syötä ohjelman kuvaus.

- ▶ Valitse haluttu kirjain säätönuppia kiertämällä.
- ▶ Tallenna haluttu kirjain säätönupin painikkeella.
- ▶ Peruuta edellinen kirjain painamalla painiketta. .
- ▶ Vahvista toiminto painamalla painiketta .
- ▶ Vahvista toiminto painamalla painiketta .





Uuden ohjelman tallentaminen jo varattuun muistipaikkaan vaatii ensin kyseisen muistipaikan poistamisen muistista.

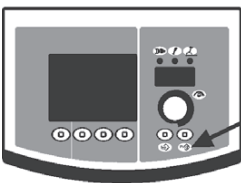

- ▶ Vahvista toiminto painamalla painiketta .
- ▶ Poista valittu ohjelma painamalla painiketta. .
- ▶ Jatka tallennusmenettelyä.

Ohjelman hakeminen





- ▶ Hae 1 olemassa oleva ohjelma painamalla painiketta .
- ▶ Valitse haluttu ohjelma säätönuppia kiertämällä.
- ▶ Valitse haluttu ohjelma painamalla painiketta. .



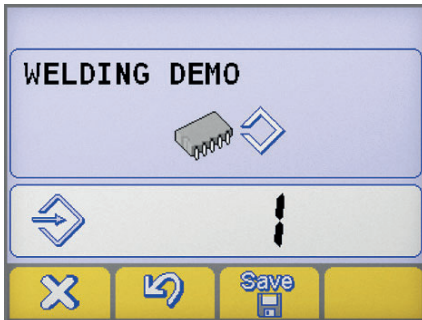

Vain muistipaikat, joissa on ohjelma, näkyvät näytöllä; tyhjät paikat ohitetaan automaattisesti.

Ohjelman peruutus

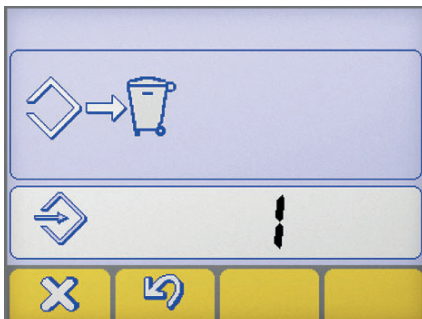

- ▶ Valitse haluttu ohjelma säätönuppia kiertämällä.
- ▶ Poista valittu ohjelma painamalla painiketta. .
- ▶ Vahvista toiminto painamalla painiketta .



- ▶ Vahvista toiminto painamalla painiketta .
- ▶ Poista valittu ohjelma painamalla painiketta. .

5. SETUP

5.1 Set up ja parametrien säätö

Sen avulla voidaan suorittaa lisäparametrien asetus ja säätö hitsauslaitteen käytön helpottamiseksi ja tarkentamiseksi. Set up parametrit on järjestetty valitun hitsausmenetelmän mukaisesti, ja niillä on numeerinen koodi.

Set up:iin pääsy



- ▶ Paina 5 sekuntia kooderinäppäintä.
- ▶ Avaus vahvistetaan näytöllä näkyvällä 0-merkillä.

Halutun parametrin valinta ja säätö

- ▶ Käännä kooderia, kunnes haluttua parametria vastaava numerokoodi tulee näkyviin.
- ▶ Kun nyt painetaan kooderi-näppäintä, saadaan näyttöön valitun parametrin asetusarvo ja säätö.

Poistuminen set up'ista

- ▶ säätö lohkoista poistutaan painamalla uudelleen kooderi-näppäintä.
- ▶ Set up'ista poistutaan siirtymällä parametrin "0" kohdalle (tallenna ja poistu) painaen kooderi-näppäintä.
- ▶ Vahvasta toiminto painamalla painiketta
- ▶ Muutos tallennetaan ja asetustilasta poistutaan painamalla näppäintä:

5.1.1 Set up parametrien luettelo (MMA)

0

Tallenna ja poistu

Sen avulla voidaan tallentaa muutokset ja poistua set up'ista.



1

Reset

Sen avulla kaikki parametrit voidaan asettaa uudelleen Oletusihin.



3

Hot start

Kuumakäynnistyksen (Hot start) arvon säätö puikkohitsauksessa.

Sillä saadaan "kuuma" käynnistys kaaren sytytysvaiheessa, mikä helpottaa aloitustoimenpiteitä.



Emäspuikko elektrodi

Minimi	Maksimi	Oletus
0/off	500%	80%

Selluloosa elektrodi

Minimi	Maksimi	Oletus
0/off	500%	150%

CrNi-elektrodi

Minimi	Maksimi	Oletus
0/off	500%	100%

Alumiini elektrodi

Minimi	Maksimi	Oletus
0/off	500%	120%

Valurauta elektrodi

Minimi	Maksimi	Oletus
0/off	500%	100%

7

Hitsausvirta

Hitsausvirran säätö.



Minimi	Maksimi	Oletus
3 A	I _{max}	100 A

8 Arc force

Kaaritehon (Arc force) arvon säätö puikkohitsauksessa.

Sen avulla hitsauksessa saadaan energinen dynaaminen vastus, mikä tekee hitsaamisen helpoksi.

Kaarivoiman arvon lisääminen vähentää elektrodin tarttumisriskiä.

Emäspuikko elektrodi

Minimi	Maksimi	Oletus
0/off	500%	30%

Selluloosa elektrodi

Minimi	Maksimi	Oletus
0/off	500%	350%

CrNi-elektrodi

Minimi	Maksimi	Oletus
0/off	500%	30%

Alumiini elektrodi

Minimi	Maksimi	Oletus
0/off	500%	100%

Valurauta elektrodi

Minimi	Maksimi	Oletus
0/off	500%	70%

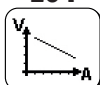
204 Dynamic power control (DPC)

Mahdollistaa halutun V/I-käyrän valinnan.

I=C Vakiovirta

Kaaren korkeuden lisäämisellä tai vähentämisellä ei ole vaikutusta vaadittavaan hitsausvirtaan.

Suosittelaa elektrodille: Emäspuikko, Rutiili, Haponkestävä puikko, Teräs, Valurauta

1:20 Laskevan rampin ohjaus

Kaaren korkeuden lisääminen aiheuttaa hitsausvirran pienenemisen (ja päinvastoin) annetun arvon mukaisesti välillä 1 - 20 ampeeria voltille.

Suosittelaa elektrodille: Selluloosa, Alumiini

P=C Vakioteho

Kaaren korkeuden lisääminen aiheuttaa hitsausvirran pienenemisen (ja päinvastoin) seuraavan kaavan mukaisesti: $V \cdot I = K$

Suosittelaa elektrodille: Selluloosa, Alumiini

312 Valokaaren irrotusjännite

Voidaan asettaa jännitteen arvo, jossa sähköinen valokaari sammuu.

Helpottaa toimintoja eri olosuhteissa.

Esimerkiksi pistehitsausvaiheessa, valokaaren alhaisen irrotusjännitteen ansiosta liekki sammuu vähemmän elektrodin irtaantuessa kappaleesta. Näin roiskeet, palamiset ja kappaleen hapettuminen ovat vähäisempiä.

Korkeaa jännitettä vaativia elektrodeja käytettäessä, tulee sen sijaan asettaa korkea raja, jotta valokaari ei sammua hitsauksen aikana.



Älä koskaan aseta generaattorin tyhjäkäyntijännitettä korkeampaa irrotusjännitettä.

Emäspuikko elektrodi

Minimi	Maksimi	Oletus
0/off	99.9 V	57.0 V

Selluloosa elektrodi

Minimi	Maksimi	Oletus
0/off	99.9 V	70.0 V

399 Leikkausnopeus

Mahdollistaa hitsausnopeuden asettamisen.

Default cm/min: referenssinopeus käsin hitsattaessa.

Syn: Sinergic arvo.

Minimi	Maksimi	Oletus
1 cm/min	200 cm/min	15 cm/min

500 Laitteen asetus

Mahdollistaa halutun graafisen käyttöliittymän valinnan.

Mahdollistaa pääsyn korkeammille asetustasoille.

Katso kappale "Käyttöliittymän mukauttaminen (Set up 500)"

Arvo	Käyttöliittymä	Arvo	Valittu taso
XE	Easy-toiminto	USER	Käyttäjä
XA	Advanced-toiminto	SERV	Service
XP	Professional-toiminto	vaBW	vaBW

551 Lock/unlock
 Mahdollistaa paneelin säätimien lukitsemisen ja salasanan asettamisen.
 Katso kappale "Lock/unlock (Set up 551)".



552 Summerin ääni
 Summerin äänen säätö.



Minimi	Maksimi	Oletus
0/off	10	10

601 Säätöaskel
 Mahdollistaa parametrin säädön käyttäjän haluamin säätöaskelin.



Minimi	Maksimi	Oletus
1	Imax	1

602 Ulkoinen parametri CH1, CH2, CH3, CH4
 Mahdollistaa ulkoisen parametrin 1, 2, 3, 4 (minimiarvo, Maksimiarvo, Oletus, valittu parametri).
 Katso kappale "Ulkoisten säätimien hallinta (Set up 602)".



705 Piirin resistanssin kalibrointi
 Mahdollistaa järjestelmän kalibroinnin.
 Katso kappale "Piirin resistanssin kalibrointi (set up 705)".



751 Virtalukema
 Mahdollistaa hitsausvirran todellisen arvon näytön.



752 Jännitelukema
 Mahdollistaa hitsausjännitteen todellisen arvon näytön.



768 Lämmöntuoton arvo HI
 Mahdollistaa hitsauksen lämmöntuoton mittausrvon lukemisen.



5.1.2 Asetusparametrien (TIG) luettelo

0 Tallenna ja poistu
 Sen avulla voidaan tallentaa muutokset ja poistua set up'ista.



1 Reset
 Sen avulla kaikki parametrit voidaan asettaa uudelleen Oletusihin.



7 Hitsausvirta
 Hitsausvirran säätö.



Minimi	Maksimi	Oletus
3 A	Imax	100 A

399 Leikkausnopeus
 Mahdollistaa hitsausnopeuden asettamisen.
 Default cm/min: referenssinopeus käsin hitsattaessa.
 Syn: Sinergic arvo.



Minimi	Maksimi	Oletus
1 cm/min	200 cm/min	10 cm/min

500 Laitteen asetus

Mahdollistaa halutun graafisen käyttöliittymän valinnan.
Mahdollistaa pääsyn korkeammille asetustasoille.
Katso kappale "Käyttöliittymän mukauttaminen (Set up 500)"

Arvo	Käyttöliittymä	Arvo	Valittu taso
XE	Easy-toiminto	USER	Käyttäjä
XA	Advanced-toiminto	SERV	Service
XP	Professional-toiminto	vaBW	vaBW

551 Lock/unlock

Mahdollistaa paneelin säätimien lukitsemisen ja salasanan asettamisen.
Katso kappale "Lock/unlock (Set up 551)".

552 Summerin ääni

Summerin äänen säätö.

Minimi	Maksimi	Oletus
0/off	10	10

601 Säätöaskel

Mahdollistaa parametrin säädön käyttäjän haluamin säätöaskelin.

Minimi	Maksimi	Oletus
1	Imax	1

602 Ulkoinen parametri CH1, CH2, CH3, CH4

Mahdollistaa ulkoisen parametrin 1, 2, 3, 4 (minimiarvo, Maksimiarvo, Oletus, valittu parametri).
Katso kappale "Ulkoisten säätimien hallinta (Set up 602)".

705 Piirin resistanssin kalibrointi

Mahdollistaa järjestelmän kalibroinnin.
Katso kappale "Piirin resistanssin kalibrointi (set up 705)".

751 Virtalukema

Mahdollistaa hitsausvirran todellisen arvon näytön.

752 Jännitelukema

Mahdollistaa hitsausjännitteen todellisen arvon näytön.

755 Kaasuvirtauksen lukema (WFR)

Mahdollistaa kaasun todellisen virtauksen näytön.

757 Langan nopeus

Moottorin 1 kooderin lukema.

760 Virtalukema (moottori 1)

Mahdollistaa moottorin todellisen arvon näytön (moottori 1).

764 Jäähdytysnesteen virtauslukema

Mahdollistaa jäähdytysnesteen virtauslukema.

765 Jäähdytysnesteen lämpötila lukema

Mahdollistaa jäähdytysnesteen lämpötila todellisen arvon näytön.

768 Lämmöntuoton arvo HI

Mahdollistaa hitsauksen lämmöntuoton mittausrvon lukemisen.

801 Suojarajat

Mahdollistaa varoitusrajoiden ja suojarajojen asettamisen.

Mahdollistaa hitsausprosessin hallinnan asettamalla varoitusrajat ja suojarajat tärkeimmille mitattaville parametreille.

Mahdollistaa eri hitsausvaiheiden tarkan säädön.

Katso kappale "Suojarajat (Set up 801)".

5.1.3 Asetusparametrien (MIG/MAG) luettelo**0 Tallenna ja poistu**

Sen avulla voidaan tallentaa muutokset ja poistua set up'ista.

1 Reset

Sen avulla kaikki parametrit voidaan asettaa uudelleen Oletusihin.

2 Synergia**MIG/MAG Standard:**

Mahdollistaa manuaalisen MIG (Off) tai synergisen MIG (6) prosessin valinnan asettamalla hitsattava materiaali.

Pulssitettu MIG/MAG:

Mahdollistaa synergisen MIG (6) prosessin valinnan asettamalla hitsattava materiaali.
Mahdollistaa CC/CV prosessin.

3 Langan nopeus

Mahdollistaa langan syöttönopeuden säädön.

Minimi	Maksimi	Oletus
0.5 m/min	22.0 m/min	-

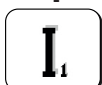
4 Virta

Hitsausvirran säätö.

Minimi	Maksimi
3 A	I _{max}

5 Kappaleen paksuus

Mahdollistaa hitsattavan osan paksuuden asettamisen.

Mahdollistaa järjestelmän asettamisen hitsattavan osan säätöihin.

6 Kulmapalko "a"

Mahdollistaa palon syvyyden valinnan kulmahitsiä varten.

7 Jännite - kaaren pituus

Mahdollistaa kaarijännitteen säädön.
 Mahdollistaa kaaren pituuden säädön hitsauksen aikana.
 Korkea jännite = pitkä kaari
 Matala jännite = lyhyt kaari

Käsihitsaus

Minimi	Maksimi	Oletus
5.0 V	55.5 V	5.0 V

10 Kaasun esivirtaus

Sen avulla voidaan asettaa ja säätää kaasun virtaus ennen valokaaren sytytystä.
 Sen avulla voidaan ladata kaasu polttimeen ja valmistella työskentelytila hitsausta varten.

Minimi	Maksimi	Oletus
0/off	99.9 s	0.1 s

11 Soft start

Sen avulla voidaan säätää langansyöttönopeus sytytystä edeltävissä vaiheissa.
 Mahdollistaa hitaamman aloituksen, joka on pehmeämpi ja lähes roiskeeton.

Minimi	Maksimi	Oletus
10 %	100 %	50 %

12 Moottorin ramppi

Sen avulla voidaan asettaa asteittainen kulku langan nopeuden välille sytytyksessä ja hitsauksessa.

Minimi	Maksimi	Oletus
0/off	1.0 s	0/off

15 Burn back



Sen avulla voidaan säätää langan palamisnopeus, estäen kiinnitarttumisen hitsauksen lopussa.
 Polttimen ulkopuolisen langan pituutta voidaan säätää.

Minimi	Maksimi	Oletus
-2.00	+2.00	0/syn

16 Kaasun jälkivirtaus

Kaasun virtauksen säätö hitsaustapahtuman lopussa.

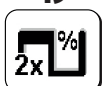
Minimi	Maksimi	Oletus
0/off	99.9 s	2.0 s

19 Duty cycle (kaksoispulssi)

Mahdollistaa loppuvirran pitoajan asettamisen.

Minimi	Maksimi	Oletus
10 %	90 %	50 %

20 Kaksoispulssitus

Mahdollistaa pulssiampplitudin säädön.

Minimi	Maksimi	Oletus
0 %	100 %	±25 %
Minimi	Maksimi	Oletus
0.5 m/min	22 m/min	2.5 m/min

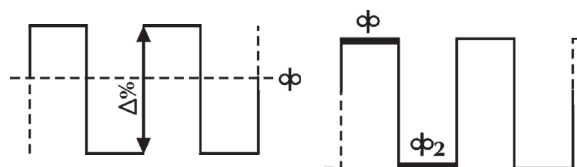
21 Pulssitaajuus (kaksoispulssi)

Mahdollistaa jakson, eli pulssin toistosyklin, säädön.
 Mahdollistaa pulssitaajuuden säädön.

Minimi	Maksimi	Oletus
0.1 Hz	5.0 Hz	2.0 Hz

22 Toisiojännite (kaksoispulssi)



Mahdollistaa toisen pulssitasojännitteen säädön.
Mahdollistaa vakaamman kaaren saavuttamisen eri pulssivaiheissa.

Minimi	Maksimi	Oletus
-5.0	+5.0	0/syn

23 Pulssi-slope (kaksoispulssi)



Mahdollistaa ramppiajan asetuksen pulssihitsauksessa.

Minimi	Maksimi	Oletus
1 %	100 %	50 %

24 Bilevel (4T - crater filler)



Kaksitasoisen langan nopeus bilevel-hitsausmuodossa.

Jos hitsaaja painaa liipasinta ja vapauttaa sen taas nopeasti, siirrytään " Φ_2 ":een.

Painamalla ja vapauttamalla liipasinta nopeasti, siirrytään taas " Φ ":een, j.n.e.

Minimi	Maksimi	Oletus
1 %	200 %	0/off

25 Alkuaskel



Mahdollistaa langan nopeuden säädön hitsauksen ensimmäisen "kraatterintäyttövaiheen" aikana.

Mahdollistaa osaan kohdistuvan energiamäärän lisäämisen, kun (edelleen kylmä) materiaali vaatii enemmän lämpöä sulaakseen tasaisesti.

Minimi	Maksimi	Oletus
20 %	200 %	120 %

26 Crater filler



Mahdollistaa langan nopeuden säädön hitsauksen loppuvaiheessa.

Mahdollistaa osaan kohdistuvan energiamäärän pienentämisen vaiheessa, jolloin materiaali on jo hyvin kuuma, ja näin ei-toivottujen muodonmuutosten vähentämisen.

Minimi	Maksimi	Oletus
20 %	200 %	80 %

27 Alkuaskelen aika



Mahdollistaa alkuaskelen ajan asettamisen.

Mahdollistaa "kraatterintäytön" automatisoinnin.

Minimi	Maksimi	Oletus
0.1 s	99.9 s	0/off

28 Kraatterin täyttöaika



Mahdollistaa "kraatterin täyttöajan" asettamisen.

Mahdollistaa "kraatterintäytön" automatisoinnin.

Minimi	Maksimi	Oletus
0.1 s	99.9 s	0/off

30 Pistehitsaus



Mahdollistaa "pistehitsausprosessin" käytön ja hitsausajan asettamisen.

Minimi	Maksimi	Oletus
0.1 s	99.9 s	0/off

31 Pysähdyspiste



Sen avulla voidaan käynnistää "pysähdyspiste" sekä määritellä hitsausten välinen tauko aika.

Minimi	Maksimi	Oletus
0.1 s	99.9 s	0/off

32 Toisiojännite (Bilevel MIG)

Mahdollistaa toisen pulssitason jännitteen säädön.
 Mahdollistaa vakaamman kaaren saavuttamisen eri pulssivaiheissa.

Minimi	Maksimi	Oletus
-5.0	+5.0	0/syn

33 Toisioinduktanssi (Bilevel MIG)

Mahdollistaa toisen pulssitason induktanssi säädön.
 Mahdollistaa nopeamman tai hitaamman kaaren saavuttamisen hitsaajan liikkeiden ja hitsauksen luonnollisen epävakauden kompensoimiseksi.

Matala induktanssi = herkästi reagoiva kaari (enemmän roiskeita).
 Korkea induktanssi = hitaammin reagoiva kaari (vähemmän roiskeita).

Minimi	Maksimi	Oletus
-30	+30	0/syn

34 Aloitusvirran nousu

Asettaa aloitusvirran asteittaisen kasvun hitsausvirtaan.

Minimi	Maksimi	Oletus
0 s	10 s	0/off

35 Kraatterin täyttöaika

Asettaa asteittaisen siirtymisen hitsausvirrasta kraatterintäyttövirtaan.

Minimi	Maksimi	Oletus
0 s	10 s	0/off

202 Induktanssi

Mahdollistaa hitsauspiirin sarjainduktanssin elektronisen säädön.
 Mahdollistaa nopeamman tai hitaamman kaaren saavuttamisen hitsaajan liikkeiden ja hitsauksen luonnollisen epävakauden kompensoimiseksi.

Matala induktanssi = herkästi reagoiva kaari (enemmän roiskeita).
 Korkea induktanssi = hitaammin reagoiva kaari (vähemmän roiskeita).

Minimi	Maksimi	Oletus
-30	+30	0/syn

331 Kompensoitu keskijännite

Mahdollistaa hitsausjännitteen asettamisen.

399 Leikkausnopeus

Mahdollistaa hitsausnopeuden asettamisen.
 Default cm/min: referenssinopeus käsin hitsattaessa.
 Syn: Sinergic arvo.

Minimi	Maksimi	Oletus
syn min	syn max	35 cm/min

500 Laitteen asetus

Mahdollistaa halutun graafisen käyttöliittymän valinnan.
 Mahdollistaa pääsyn korkeammille asetustasoille.
 Katso kappale "Käyttöliittymän mukauttaminen (Set up 500)"

Arvo	Käyttöliittymä	Arvo	Valittu taso
XE	Easy-toiminto	USER	Käyttäjä
XA	Advanced-toiminto	SERV	Service
XP	Professional-toiminto	vaBW	vaBW

551 Lock/unlock

Mahdollistaa paneelin säätimien lukitsemisen ja salasanan asettamisen.
 Katso kappale "Lock/unlock (Set up 551)".

552 Summerin ääni

Summerin äänen säätö.



Minimi	Maksimi	Oletus
0/off	10	10

601 Säätöaskel

Mahdollistaa parametrin säädön käyttäjän haluamien säätöaskelin. Toimintaa ohjataan polttimen ylös / alas-painikkeella.



Minimi	Maksimi	Oletus
1	Imax	1

602 Ulkoinen parametri CH1, CH2, CH3, CH4

Mahdollistaa ulkoisen parametrin 1, 2, 3, 4 (minimiarvo, Maksimiarvo, Oletus, valittu parametri). Katso kappale "Ulkoisten säätimien hallinta (Set up 602)".

**606 U/D torch**

Mahdollistaa ulkoisen parametrin (U/D).



Arvo	Oletus	Soittotoiminto
0/off	-	off
1/11	X	Virta
	-	Ohjelman hakeminen

705 Piirin resistanssin kalibrointi

Mahdollistaa järjestelmän kalibroinnin. Katso kappale "Piirin resistanssin kalibrointi (set up 705)".

**751 Virtalukema**

Mahdollistaa hitsausvirran todellisen arvon näytön.

**752 Jännitelukema**

Mahdollistaa hitsausjännitteen todellisen arvon näytön.

**755 Kaasuvirtauksen lukema (WFR)**

Mahdollistaa kaasun todellisen virtauksen näytön.

**757 Langan nopeus**

Moottorin 1 kooderin lukema.

**758 Robotin liikenopeus**

Mahdollistaa robotin tai automaatiolaitteen varren liikenopeuden näytön.

**760 Virtalukema (moottori 1)**

Mahdollistaa moottorin todellisen arvon näytön (moottori 1).

**761 Langan nopeus**

Moottorin 2 kooderin lukema.



762 Virtalukema (moottori 2)

Mahdollistaa moottorin todellisen arvon näytön (moottori 2).

763 Langan nopeus

Langan syötön todellinen lukema

764 Jäähdytysnesteen virtauslukema

Mahdollistaa jäähdytysnesteen virtauslukema.

765 Jäähdytysnesteen lämpötila lukema

Mahdollistaa jäähdytysnesteen lämpötila todellisen arvon näytön.

768 Lämmöntuoton arvo HI

Mahdollistaa hitsauksen lämmöntuoton mittausarvon lukemisen.

801 Suojarajat

Mahdollistaa varoitusrajojen ja suojarajojen asettamisen.

Mahdollistaa hitsausprosessin hallinnan asettamalla varoitusrajat ja suojarajat tärkeimmille mitattaville parametreille.

Mahdollistaa eri hitsausvaiheiden tarkan säädön.

Katso kappale "Suojarajat (Set up 801)".

5.2 Parametrien erityiset käyttötoimenpiteet

5.2.1 7-segmentinäytön mukauttaminen

Mahdollistaa parametrin arvon jatkuvan näytön 7-segmentinäytöllä.

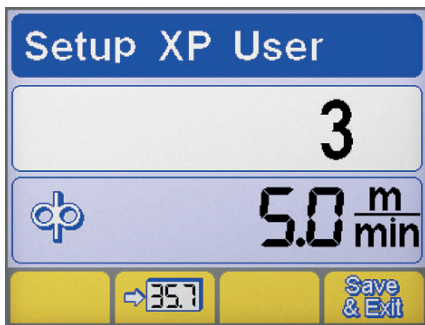

▶ Siirry set-up-tilaan painamalla säätönupin painiketta vähintään 5 sekunnin ajan.

▶ Valitse tarvittava parametri kiertämällä säätönuppia.

▶ Tallenna valittu parametri 7-segmentinäyttöön painamalla painiketta .

▶ Tallenna ja poistu nykyiseltä näytöltä painamalla painiketta .

5.2.2 Käyttöliittymän mukauttaminen (Set up 500)

Mahdollistaa parametrien mukauttamisen päävalikossa.

500 Laitteen asetus

Mahdollistaa halutun graafisen käyttöliittymän valinnan.

Arvo	Käyttöliittymä	
XE	Easy-toiminto	
XA	Advanced-toiminto	
XP	Professional-toiminto	

TOIMINTO XE

MMA

Hitsausparametrit



TIG	
Hitsausparametrit	
Toiminnot	

TOIMINTO XA

MMA	
Hitsausparametrit	
Toiminnot	

TIG	
Hitsausparametrit	
Toiminnot	

MIG/MAG	
Hitsausparametrit	
Toiminnot	

TOIMINTO XP

MMA	
Hitsausparametrit	
Toiminnot	

TIG	
Hitsausparametrit	
Toiminnot	

MIG/MAG	
Hitsausparametrit	
Toiminnot	

5.2.3 Lock/unlock (Set up 551)

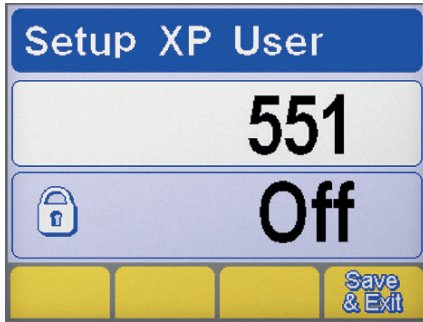

Mahdollistaa paneelin säätimien lukitsemisen ja salasanan asettamisen.

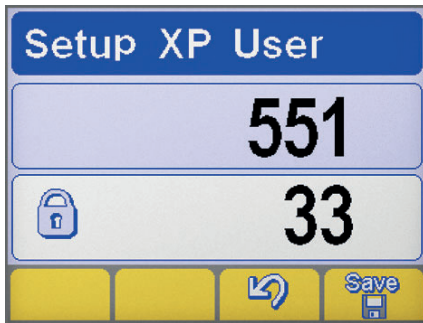

Parametrin valinta

- ▶ Siirry set-up-tilaan painamalla säätönupin painiketta vähintään 5 sekunnin ajan.
- ▶ Valitse haluttu parametri (551).
- ▶ Aktivoi valitun parametrin säätö painamalla säätönupin painiketta.





- ▶ Aseta numerokoodi (salasana) kiertämällä säätönuppia.
- ▶ Vahvasta toimenpide painamalla kooderinäppäintä.
- ▶ Vahvasta toiminto painamalla painiketta .
- ▶ Tallenna muutos painamalla painiketta: .

Paneelin toiminnot

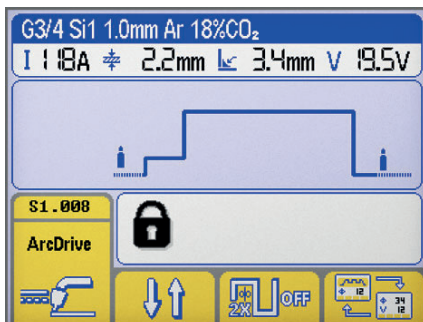

Lukitun ohjauspaneelin toimintojen käyttöyritys tuo näkyviin erityisen näytön.



- ▶ Voit vapauttaa toiminnot tilapäisesti (5 minuutiksi) antamalla oikean salasanan säätönuppia kiertämällä.
- ▶ Vahvasta toimenpide painamalla kooderinäppäintä.
- ▶ Voit vapauttaa ohjauspaneelin kokonaan siirtymällä set-up-tilaan (seuraa edellä annettuja ohjeita) ja palauttamalla parametrin 551 arvoksi "off".
- ▶ Vahvasta toimenpide painamalla kooderinäppäintä.
- ▶ Tallenna muutos painamalla painiketta: .

5.2.4 Ulkoisten säätimien hallinta (Set up 602)

Mahdollistaa ulkoisen parametrin 2 (minimiarvo, Maksimiarvo, Oletus, valittu parametri).

Parametrin valinta

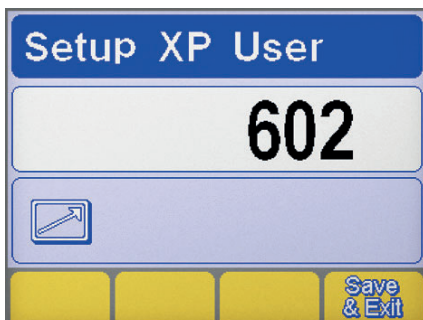

- ▶ Siirry set-up-tilaan painamalla säätönupin painiketta vähintään 5 sekunnin ajan.
- ▶ Valitse haluttu parametri (602).
- ▶ Siirry "Ulkoisten säätimien hallinta" -näytölle painamalla säätönupin painiketta.

Ulkoisten säätimien hallinta

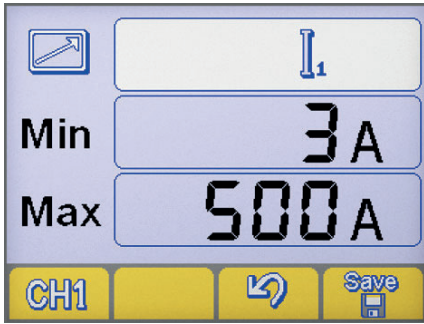

- ▶ Valitse haluttu RC-kauko-ohjauslähtö (CH1, CH2, CH3, CH4) painamalla painiketta.
- ▶ Valitse haluttu parametri (Min-Max-parametri) painamalla säätönupin painiketta.
- ▶ Säädä haluttu parametri (Min-Max-parametri) kiertämällä säätönuppia.
- ▶ Tallenna muutos painamalla painiketta:
- ▶ Vahvista toiminto painamalla painiketta

5.2.5 Piirin resistanssin kalibrointi (set up 705)

Mahdollistaa virtalähteen kalibroinnin hitsauspiiriin nykyisen vastuksen mukaan.

Parametrin valinta

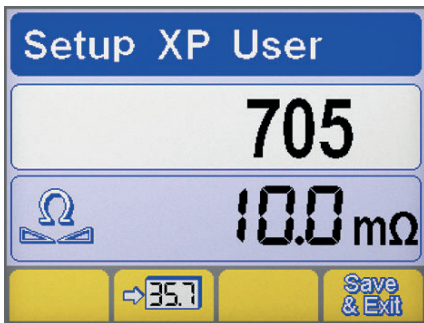

- ▶ Siirry set-up-tilaan painamalla säätönupin painiketta vähintään 5 sekunnin ajan.
- ▶ Valitse haluttu parametri (705).
- ▶ Aktivoi valitun parametrin säätö painamalla säätönupin painiketta.
- ▶ Kytke virtalähde hitsauspiiriin (pöytä tai kappale).
- ▶ Poista suojahattu paljastaaksesi polttimen suuttimen kärjen. (MIG/MAG)

Kalibrointi

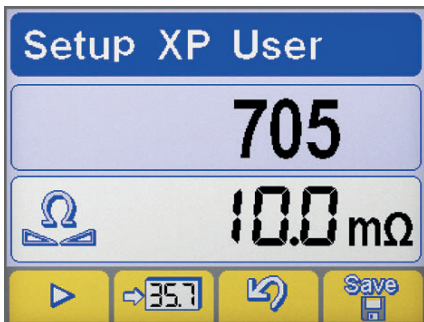

- ▶ Aseta langanohjaimen kärki sähköiseen kosketukseen työkappaleen kanssa. (MIG/MAG)
- ▶ Paina -painiketta aloittaaksesi toimenpiteen.
- ▶ Säilytä kosketus vähintään sekunnin ajan.
- ▶ Näytöllä näkyvä arvo päivitetään, kun kalibrointi on suoritettu.
- ▶ Vahvista toiminto painamalla painiketta
- ▶ Vahvista toiminto painamalla painiketta
- ▶ Muutos tallennetaan ja asetustilasta poistutaan painamalla näppäintä:

5.2.6 Suojarajat (Set up 801)

Mahdollistaa varoitusrajojen ja suojarajojen asettamisen.

Mahdollistaa hitsausprosessin hallinnan asettamalla varoitusrajat ja suojarajat tärkeimmille mitattaville parametreille.

Mahdollistaa eri hitsausvaiheiden tarkan säädön.

Huomiotasot				Suojarajat			
	Hitsausvirta				hitsausjännite		
	Kaasuvirtauksen lukema				Robotin liikenoisuus		
	Virtalukema (moottori 1)				Virtalukema (moottori 2)		
	Jäähdytysnesteen virtauslukema				Langan nopeus		
	Jäähdytysnesteen lämpötila lukema						

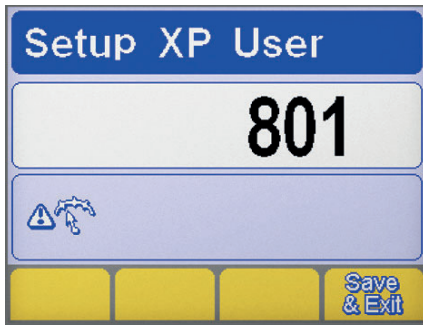
Parametrin valinta

- ▶ Siirry set-up-tilaan painamalla säätönupin painiketta vähintään 5 sekunnin ajan.
- ▶ Valitse haluttu parametri (801).
- ▶ Siirry "Suojarajat"-näytölle painamalla säätönupin painiketta.

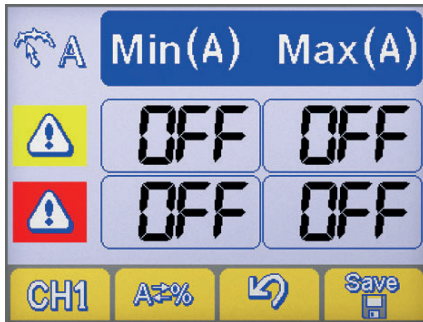
Parametrin valinta

- ▶ Valitse tarvittava parametri painamalla painiketta **CH1**.
- ▶ Valitse suojarajojen asetustapa painamalla painiketta **A=%**.

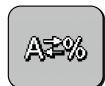
Laitteen asetus

Absoluuttinen arvo

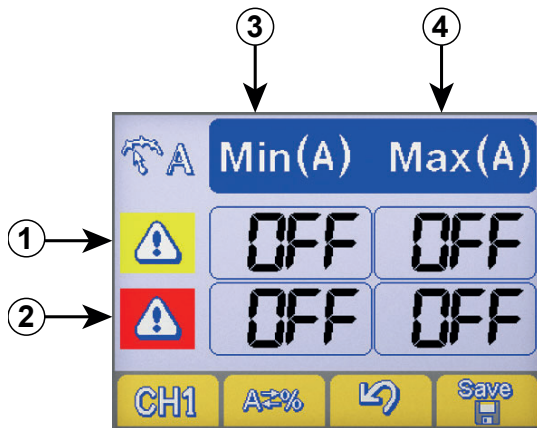

Prosenttiarvo

Turvallisuusrajojen asetus

- 1 Varoitusrajojen rivi
- 2 Häytysrajojen rivi
- 3 Minimiarvojen sarake
- 4 Maksimiarvojen sarake

- ▶ Valitse haluamasi ruutu painamalla säätönupin painiketta (valittu ruutu vaihtuu käänteisen väriseksi).
- ▶ Säädä valitun parametrin taso kiertämällä säätönuppia.
- ▶ Tallenna muutos painamalla painiketta: **Save**.



Jonkin varoitusrajan ylittyminen aiheuttaa ohjauspaneeliin visuaalisen ilmoituksen.



Jonkin varoitusrajan ylittyminen aiheuttaa ohjauspaneeliin visuaalisen ilmoituksen ja hitsausuiminnot keskeytyvät välittömästi.



On mahdollista asettaa hitsaussuodattimien alku ja loppu, jotta virhesignaalit saadaan estettyä kaaren sytytyksen ja sammutuksen aikana. (katso kappale "Set up" - parametrit 802-803-804).

6. HUOLTO



Laitteessa tulee suorittaa normaalihuolto valmis- tajan antamien ohjeiden mukaisesti. Kun laite on toimiva, kaikki laitteen suojapellit ja luukut on suljettava. Laitteeseen ei saa tehdä minkäänlaisia muutoksia. Estä metallipölyä kasaantumasta lähelle tuuletusaukkoja tai niiden päälle.



Huoltotoimia voi tehdä vain niihin pätevöitynyt henkilö. Takuun voimassaolo lakkaa, mikäli valtuuttamattomat henkilöt ovat suorittaneet laitteen korjaus- tai osien vaihtotoimenpiteitä. Ainoastaan ammattitaitoiset teknikot saavat suorittaa laitteen mahdolliset korjaus- tai osien vaihtotoimenpiteet.



Irrota laite sähköverkosta ennen huoltotoimenpiteitä.

6.1 Suorita seuraavat määräaikaiset tarkastukset virtalähteelle

6.1.1 Echipament



Puhdista virtalähde sisältä matalapaineisella paineilmasuihkulla ja pehmeällä harjalla. Tarkista sähköiset kytkennät ja kytkentäkaapelit.

6.1.2 Poltinkomponentin, puikon pitimen ja/tai maattokaapeleiden huoltoon tai vaihtoon:



Tarkista komponenttien lämpötila ja tarkista etteivät ne ole ylikuumentuneet.



Käytä aina turvallisuusmääräysten mukaisia suojakäsineitä.



Käytä aina sopivia ruuviavaimia ja työkaluja.

6.2 Răspundere



Ellei huoltoa suoriteta, kaikkien takuiden voimassaolo lakkaa eikä valmistaja vastaa aiheutuneista vahingoista. Valmistaja ei vastaa vahingoista, jotka ovat aiheutuneet siitä, ettei ylläolevia ohjeita ole noudatettu. Jos sinulla on epäselvyyksiä tai ongelmia, älä epäröi ottaa yhteyttä lähimpään huoltokeskukseen.

7. HÄLYTYSKOODIT



HÄLYTYS

Hälytyksen laukeamisesta tai kriittisen turvallisuusrajan ylityksestä ilmoitetaan ohjauspaneelin merkkivalolla. Se aiheuttaa hitsaustoimenpiteiden välittömän eston.



HUOMIO

Hälytyksen laukeamisesta tai kriittisen turvallisuusrajan ylityksestä ilmoitetaan ohjauspaneelin merkkivalolla. Se aiheuttaa hitsaustoimenpiteiden välittömän eston.

Seuraavassa luetellaan kaikki järjestelmää koskevat hälytykset ja turvallisuusrajat.



E01

Ylikuumentuminen



Ylikuumentuminen

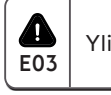

E03

Ylikuumentuminen



Ylivirta

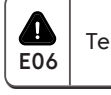

E06

Tehomodulin ylivirta (Boost)



Langansyöttölaitteen moottorin sähköjärjestelmän vika



E08

























Moteur bloqué



Tehomodulin ylivirta (Inverter)



 E11	Järjestelmän konfigurointivirhe		 E12	Yhteysvirhe (WF - DSP)	
 E13	Yhteysvirhe		 E14	Virheellinen ohjelma	
 E15	Virheellinen ohjelma		 E16	Yhteysvirhe (RI) (Automaatio ja robotiikka)	
 E17	Yhteysvirhe (µP-DSP)		 E18	Virheellinen ohjelma	
 E19	Järjestelmän konfigurointivirhe		 E20	Muistivirhe	
 E21	Datan menetys		 E22	Yhteysvirhe (DSP)	
 E29	Yhteensopimattomat mitat		 E30	Yhteysvirhe (H.F.)	
 E32	Datan menetys		 E38	Alijännite	
 E39	Laitteen sähkönsyötön vika		 E40	Laitteen sähkönsyötön vika	
 E43	Jäähdytysneste puuttuu		 E48	Lanka puuttuu (Automaatio ja robotiikka)	
 E49	Hätäseispainike (Automaatio ja robotiikka)		 E50	Lanka juuttunut (Automaatio ja robotiikka)	
 E51	Asetuksia ei tueta (Automaatio ja robotiikka)		 E52	Törmäyksenesto (Automaatio ja robotiikka)	
 E53	Ulkoisen virtauskytkimen virhe (Automaatio ja robotiikka)		 E54	Virtataso ylittynyt (Alaraja)	
 E55	Virtataso ylittynyt (Yläraja)		 E56	Jännitetaso ylittynyt (Alaraja)	
 E57	Jännitetaso ylittynyt (Yläraja)		 E60	Nopeusraja ylittynyt (Alaraja)	
 E61	Nopeusraja ylittynyt (Yläraja)		 E62	Virtataso ylittynyt (Alaraja)	
 E63	Virtataso ylittynyt (Yläraja)		 E64	Jännitetaso ylittynyt (Alaraja)	

 E65	Jännitetaso ylittynyt (Yläraja)		 E68	Nopeusraja ylittynyt (Alaraja)	
 E69	Nopeusraja ylittynyt (Yläraja)		 E70	Asetetut turvallisuusrajat yhteensopimattomia	
 E71	Jäähdytysnesteen ylikuumentuminen		 E72	Push-pull-moottorin ylivirta	
 E73	Langan nopeusraja ylittynyt (speed meter)		 E74	Moottorin 1 virtataso ylittynyt	
 E75	Moottorin 2 virtataso ylittynyt		 E76	Jäähdytysnesteen virtaustaso ylittynyt	
 E77	Jäähdytysnesteen lämpötilataso		 E78	Huolto käynnissä (Automaatio ja robotiikka)	

8. VIANMÄÄRITYS JA RATKAISUT

Laite ei käynnisty (vihreä merkkivalo ei pala)

Syy	Toimenpide
» Ei jännitettä pistorasiassa.	» Suorita tarkistus ja korjaa sähköjärjestelmä.
» Virheellinen pistoke tai kaapeli.	» Käänny ammattitaitoisen henkilön puoleen.
» Linjan sulake palanut.	» Vaihda viallinen osa.
» Sytytyskytkin viallinen.	» Käänny lähimmän huoltokeskuksen puoleen laitteen korjaamista varten.
» Langansyöttökelkan ja generaattorin välinen kytkentä virheellinen tai viallinen.	» Vaihda viallinen osa.
» Elektroniikka viallinen.	» Vaihda viallinen osa.
	» Käänny lähimmän huoltokeskuksen puoleen laitteen korjaamista varten.
	» Tarkasta, että järjestelmän eri osat on oikein kytketty.
	» Käänny lähimmän huoltokeskuksen puoleen laitteen korjaamista varten.

Ulostulojännitteen poisjäänti (laite ei hitsaa)

Syy	Toimenpide
» Polttimen liipaisin virheellinen.	» Vaihda viallinen osa.
» Laite on ylikuumentunut (lämpöhälytys - keltainen merkkivalo palaa).	» Käänny lähimmän huoltokeskuksen puoleen laitteen korjaamista varten.
» Sivupaneeli auki tai portin kytkin viallinen.	» Odota laitteen jäähtymistä sammuttamatta sitä.
» Maadoituskytkentä virheellinen.	» Laitteen käyttäjän turvallisuuden kannalta on välttämätöntä, että sivupaneeli on suljettu hitsaustoimenpiteiden aikana.
» Verkkajännite rajojen ulkopuolella (keltainen merkkivalo palaa).	» Vaihda viallinen osa.
» Elektroniikka viallinen.	» Käänny lähimmän huoltokeskuksen puoleen laitteen korjaamista varten.
	» Suorita maadoituskytkentä oikein.
	» Katso ohjeet kappaleessa "Käyttöönotto".
	» Palauta verkkajännite generaattorin syöttörajoihin.
	» Suorita laitteen kytkentä oikein.
	» Katso ohjeet kappaleesta "Kytchentä".
	» Käänny lähimmän huoltokeskuksen puoleen laitteen korjaamista varten.

Tehoulostulo virheellinen
Syy

- » Leikkausprosessin virheellinen valinta tai virheellinen valintakytkin.

- » Hitsausparametrien ja toimintojen asetus virheellinen.

- » Virransäätöpotentiometri/kooderi viallinen viallinen.

- » Verkkojännite rajojen ulkopuolella.

- » Vaiheen puuttuminen.

- » Elektroniikka viallinen.

Toimenpide

- » Valitse oikea hitsausprosessi.
- » Vaihda viallinen osa.
- » Käänny lähimmän huoltokeskuksen puoleen laitteen korjaamista varten.

- » Suorita laitteen nollaus ja aseta hitsausparametrit uudelleen.

- » Vaihda viallinen osa.
- » Käänny lähimmän huoltokeskuksen puoleen laitteen korjaamista varten.

- » Suorita laitteen kytkentä oikein.
- » Katso ohjeet kappaleesta "KytKentä".

- » Suorita laitteen kytkentä oikein.
- » Katso ohjeet kappaleesta "KytKentä".

- » Käänny lähimmän huoltokeskuksen puoleen laitteen korjaamista varten.

Langansyöttö jumissa
Syy

- » Polttimen liipaisin virheellinen.

- » Rullat virheelliset tai kuluneet.

- » Vaihdemoottori viallinen.

- » Polttimen suoja viallinen.

- » Langansyöttölaitteessa ei ole virtaa.

- » Kelaus epätasaista kelalla.

- » Polttimen suutin sulanut (lanka tarttunut kiinni).

Toimenpide

- » Vaihda viallinen osa.
- » Käänny lähimmän huoltokeskuksen puoleen laitteen korjaamista varten.

- » Vaihda rullat.

- » Vaihda viallinen osa.
- » Käänny lähimmän huoltokeskuksen puoleen laitteen korjaamista varten.

- » Vaihda viallinen osa.
- » Käänny lähimmän huoltokeskuksen puoleen laitteen korjaamista varten.

- » Tarkista kytkentä generaattoriin.
- » Katso ohjeet kappaleesta "KytKentä".
- » Käänny lähimmän huoltokeskuksen puoleen laitteen korjaamista varten.

- » Palauta kelan normaalitoimintaolosuhteet tai vaihda se uuteen.

- » Vaihda viallinen osa.

Langansyöttö on epätasainen
Syy

- » Polttimen liipaisin virheellinen.

- » Rullat virheelliset tai kuluneet.

- » Vaihdemoottori viallinen.

- » Polttimen suoja viallinen.

- » Kelan kitka tai rullien lukituslaitteet säädetty väärin.

Toimenpide

- » Vaihda viallinen osa.
- » Käänny lähimmän huoltokeskuksen puoleen laitteen korjaamista varten.

- » Vaihda rullat.

- » Vaihda viallinen osa.
- » Käänny lähimmän huoltokeskuksen puoleen laitteen korjaamista varten.

- » Vaihda viallinen osa.
- » Käänny lähimmän huoltokeskuksen puoleen laitteen korjaamista varten.

- » Löysennä kitkaa.
- » Lisää painetta rulliin.

Kaaren epävakaisuus
Syy

- » Huono kaasusuojaus.

- » Hitsauskaasussa on kosteutta.

Toimenpide

- » Sääda oikea kaasun virtaus.
- » Tarkista, että polttimen hajotin ja kaasusuulake ovat hyväkuntoisia.

- » Käytä aina hyvälaatuisia tuotteita ja materiaaleja.
- » Pidä kaasunsyöttöjärjestelmä aina hyvässä kunnossa.

» Hitsausparametrit väärä.

» Tarkista huolellisesti hitsauslaite.

» Käänny lähimmän huoltokeskuksen puoleen laitteen korjaamista varten.

Runsas roiske

Syy

» Pitkä valokaari.

» Hitsausparametrit väärä.

» Huono kaasusuojaus.

» Valokaaren dynamiikka väärä.

» Hitsauksen suoritustapa väärä.

Toimenpide

» Pienennä elektrodin ja kappaleen välistä etäisyyttä.

» Pienennä hitsattavien kappaleiden.

» Pienennä hitsausvirtaa.

» Säädä oikea kaasun virtaus.

» Tarkista, että polttimen hajotin ja kaasusuulake ovat hyväkuntoisia.

» Kohota piirin induktiivista arvoa.

» Käytä suurempaa induktiivista kytkentää.

» Vähennä polttimen kallistumista.

Riittämätön tunkeutuminen

Syy

» Hitsauksen suoritustapa väärä.

» Hitsausparametrit väärä.

» Väärä elektrodi.

» Reunojen valmistelu väärä.

» Maadoituskytkentä virheellinen.

» Huomattavan kokoiset hitsattavat kappaleet.

Toimenpide

» Pienennä hitsauksen etenemisnopeutta.

» Suurena hitsausvirtaa.

» Käytä ohuempaa elektrodia.

» Paranna railomuotoa.

» Suorita maadoituskytkentä oikein.

» Katso ohjeet kappaleessa "Käyttöönotto".

» Suurena hitsausvirtaa.

Kuonasulkeumat

Syy

» Puutteellinen kuonanpoisto.

» Elektrodin halkaisija liian suuri.

» Reunojen valmistelu väärä.

» Hitsauksen suoritustapa väärä.

Toimenpide

» Puhdista kappaleet huolellisesti ennen hitsaamista.

» Käytä ohuempaa elektrodia.

» Paranna railomuotoa.

» Pienennä elektrodin ja kappaleen välistä etäisyyttä.

» Etene säännöllisesti kaikkien hitsausvaiheiden aikana.

Volframisulkeuma

Syy

» Hitsausparametrit väärä.

» Väärä elektrodi.

» Hitsauksen suoritustapa väärä.

Toimenpide

» Pienennä hitsausvirtaa.

» Käytä paksumpaa elektrodia.

» Käytä aina hyvälaatuisia tuotteita ja materiaaleja.

» Teroita elektrodi oikein.

» Vältä elektrodilla koskemista sulaan.

Huokoisuus

Syy

» Huono kaasusuojaus.

Toimenpide

» Säädä oikea kaasun virtaus.

» Tarkista, että polttimen hajotin ja kaasusuulake ovat hyväkuntoisia.

Takertuminen

Syy

» Pitkä valokaari.

» Hitsausparametrit väärä.

» Hitsauksen suoritustapa väärä.

» Huomattavan kokoiset hitsattavat kappaleet.

» Valokaaren dynamiikka väärä.

Toimenpide

» Lisää elektrodin ja työkappaleen välistä etäisyyttä.

» Lisää hitsausjännitettä.

» Suurena hitsausvirtaa.

» Lisää hitsausjännitettä.

» Kallista poltinta mahdollisimman paljon kulman suuntaiseksi.

» Suurena hitsausvirtaa.

» Kohota piirin induktiivista arvoa.

» Käytä suurempaa induktiivista kytkentää.

Reunahaavat
Syy

- » Hitsausparametrit väärä.

- » Pitkä valokaari.

- » Hitsauksen suoritustapa väärä.

- » Huono kaasusuojaus.

Toimenpide

- » Pienennä hitsausvirtaa.
- » Käytä ohuempaa elektrodia.

- » Pienennä elektrodin ja kappaleen välistä etäisyyttä.
- » Pienennä hitsattavien kappaleiden.

- » Pienennä sivun värähtelynopeutta täytettäessä.
- » Pienennä hitsauksen etenemisnopeutta.

- » Käytä hitsattaviin materiaaleihin soveltuvia kaasuja.

Hapettuma
Syy

- » Huono kaasusuojaus.

Toimenpide

- » Säädä oikea kaasun virtaus.
- » Tarkista, että polttimen hajotin ja kaasusuulake ovat hyväkuntoisia.

Huokoisuus
Syy

- » Rasvaa, maalia, ruostetta tai likaa hitsattavissa kappaleissa.

- » Öljyinen, maallinen, ruosteinen tai likainen lisäaine.

- » Kosteaa lisäaine.

- » Pitkä valokaari.

- » Hitsauskaasussa on kosteutta.

- » Huono kaasusuojaus.

- » Hitsisulan liian nopea jähmettyminen.

Toimenpide

- » Puhdista kappaleet huolellisesti ennen hitsaamista.

- » Käytä aina hyvälaatuisia tuotteita ja materiaaleja.
- » Pidä lisäaine aina hyvässä kunnossa.

- » Käytä aina hyvälaatuisia tuotteita ja materiaaleja.
- » Pidä lisäaine aina hyvässä kunnossa.

- » Pienennä elektrodin ja kappaleen välistä etäisyyttä.
- » Pienennä hitsattavien kappaleiden.

- » Käytä aina hyvälaatuisia tuotteita ja materiaaleja.
- » Pidä kaasunsyöttöjärjestelmä aina hyvässä kunnossa.

- » Säädä oikea kaasun virtaus.
- » Tarkista, että polttimen hajotin ja kaasusuulake ovat hyväkuntoisia.

- » Pienennä hitsauksen etenemisnopeutta.
- » Esikuumenna hitsattavat kappaleet.
- » Suurena hitsausvirtaa.

Kuumahalkeamat
Syy

- » Hitsausparametrit väärä.

- » Rasvaa, maalia, ruostetta tai likaa hitsattavissa kappaleissa.

- » Öljyinen, maallinen, ruosteinen tai likainen lisäaine.

- » Hitsauksen suoritustapa väärä.

- » Hitsattavat kappaleet toisistaan eroavilla ominaisuuksilla.

Toimenpide

- » Pienennä hitsausvirtaa.
- » Käytä ohuempaa elektrodia.

- » Puhdista kappaleet huolellisesti ennen hitsaamista.

- » Käytä aina hyvälaatuisia tuotteita ja materiaaleja.
- » Pidä lisäaine aina hyvässä kunnossa.

- » Suorita toimenpiteet oikeassa järjestyksessä hitsattavan sauman mukaisesti.

- » Rasvaa ennen hitsaamista.

Kylmähalkeamat
Syy

- » Kosteaa lisäaine.

- » Hitsattavan liitoksen erikoinen muoto.

Toimenpide

- » Käytä aina hyvälaatuisia tuotteita ja materiaaleja.
- » Pidä lisäaine aina hyvässä kunnossa.

- » Esikuumenna hitsattavat kappaleet.
- » Suorita jälkilämpökäsittely.
- » Suorita toimenpiteet oikeassa järjestyksessä hitsattavan sauman mukaisesti.

9. HITSAUKSEN TEORIAA

9.1 Puikkohitsaus (MMA)

Reunojen viimeistely

Jotta saavutettaisiin hyvä hitsaussauma tulee liitokappaleiden olla puhtaita liasta ja ruosteesta.

Puikon valinta

Käytettävän hitsauspuikon halkaisija riippuu materiaalin paksuudesta, asennosta, liitoksen tyyppistä sekä hitsattavan kappaleen valmistustavasta. Suuremman läpimitan omaavat hitsauspuikot vaativat suuremman hitsausvirran ja tuottavat paljon lämpöä hitsatessa.

Hitsauspuikon tyyppi	Puikon ominaisuus	Käyttökohde
Rutiilipuikko	Helppo hitsattavuus	Kaikkiin
Haponkestävä puikko	Suuri sulamisnopeus	Tasaisiin
Emäspuikko	Mekaaniset ominaisuudet	Kaikkiin

Hitsausvirran valinta

Hitsauspuikon valmistaja on määritellyt oikean hitsausvirran alueen kullekin puikkotyypille erikseen. Ohjeet sopivan hitsausvirran raja-arvoista löytyvät hitsauspuikkopakkauksesta.

Valokaaren sytytys ja sen ylläpito

Hitsausvalokaari sytytetään raapimalla hitsauspuikon päätä maadoitettuun työkappaleeseen. Hitsauspuikon päätä vedetään pois päin työkappaleesta normaaliin työetäisyyteen heti, kun valokaari on syttynyt.

Hitsauspuikon sytyttämisen helpottamiseksi hitsauskoneessa on toiminto, joka kohottaa hitsausjännitettä hetkellisesti (Hot Start) Kun valokaari on syttynyt, hitsauspuikon sisäosa sulaa ja siirtyy pisaroiden muodossa työkappaleeseen. Hitsauspuikossa ulompana oleva lisäaineosa kaasuntuu ja muodostaa suojakaasun ja mahdollistaa korkeatasoisen hitsaussauman. Hitsauskoneessa on toiminto, joka ehkäisee sulan metallin roiskeiden aiheuttaman valokaaren sammumisen (Arc Force). Siinä tapauksessa, että hitsauspuikko juuttuu kiinni hitsattavaan kappaleeseen tulee oikosulkuvirta vähentää minimiin (antisticking).

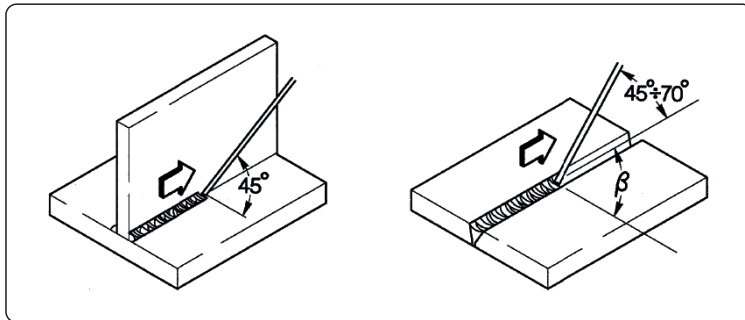

Hitsaaminen

Hitsauspuikon kulma työkappaleeseen nähden vaihtelee sen mukaan, kuinka moneen kertaan sauma hitsataan; normaalisti hitsauspuikkoa heilutetaan sauman puolelta toiselle pysähtyen sauman reunalla. Näin vältetään täyteaineen kasautuminen sauman keskelle.

Kuonan poisto

Puikkohitsaukseen sisältyy kuonan poisto jokaisen hitsausvaiheen jälkeen. Kuona poistetaan kuonahakulla ja teräsharjalla.

9.2 TIG-hitsaus (jatkuva kaari)

Kuvaus

TIG (Tungsten Inert Gas)-hitsausprosessi perustuu valokaaren sulamattoman hitsauspuikon (tavallisesti puhdasta tai sekoitettua volframia, sulamispiste n. 3370°C) ja työkappaleen välillä. Hitsaustapahtuma suojataan Argon-suojakaasulla. Jotta vältetään volframin vaaralliselta syttymiseltä liitoksessa, ei elektrodi saa koskaan pästä kosketukseen hitsattavan kappaleen kanssa. Tämän vuoksi kehitetään HF-generaattorilla suoja, jonka avulla sytytys voi tapahtua sähköisen valokaaren ulkopuolella. Laitteen avulla valokaari saadaan syttymään jo varsin etäällä työkappaleesta. Toisenlainen valokaaren sytytys on myös mahdollinen: ns. nostosytytys, joka ei vaadi korkeataajuussytytyslaitetta, vaan lyhyen oikosulun alhaisella virralla puikon ja työkappaleen välille. Kun puikkoa tällöin nostetaan, valokaari syttyy ja hitsausvirta lisääntyy kunnes se saavuttaa oikeat hitsausarvot. Tavanomainen raapaisu-sytytys ei toisaalta takaa korkealuokkaista hitsaussaumaa sauman alussa. Hitsauslangan loppupään laadun parantamiseksi on hyvä seurata hitsausvirran vähenemistä tarkoin; kaasun tulee myös virrata muutaman sekunnin ajan hitsisulassa valokaaren sammumisen jälkeen. Monissa työskentelyolosuhteissa on hyvä käyttää kahta valmiiksi asetettua hitsausvirtaa, jolloin voidaan siirtyä helposti yhdestä toiseen (BILEVEL).

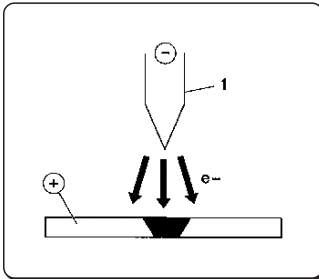
Hitsausnapaisuus

Normaali napaisuus (-napa polttimessa)

Edellä mainittua napaisuutta käytetään eniten, sillä tällöin 70% lämmöstä johtuu työkappaleeseen ja hitsauspuikon (1) kuluminen on vähäistä.

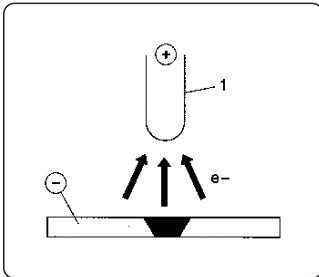
Em. napaisuudella pystytään hitsaamaan syviä ja kapeita hitsausnaumoja nopeasti ja ilman turhaa lämmönmuodostusta.

Käänteinen napaisuus (+napa polttimessa)

Käänteistä napaisuutta käytetään hitsattaessa seosmetalleja, joissa on pinnalla korkean sulamispisteen omaavaa hapettumakerros.

Korkeita hitsausvirtoja ei kuitenkaan voida käyttää, koska se aiheuttaisi puikon nopean kulumisen käyttökelvottomaksi.

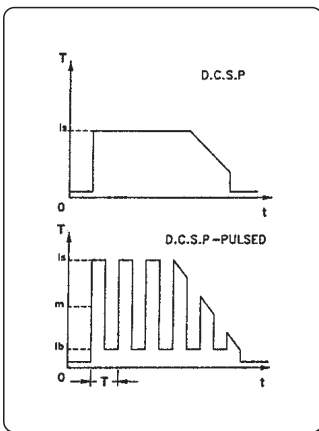
D.C.S.P.-Pulsed (Direct Current Straight Polarity Pulsed)

Yhden jatkuvan vaihtovirran käyttö helpottaa hitsisulan kontrollia erityisissä työskentelyolosuhteissa.

Hitsisula muodostuu materiaalin sulaneista kohdista (Ip), kantavirta taas (Ib) pitää valokaaren palamassa; tämä helpottaa ohuiden materiaalien hitsausta, jolloin muodostuu pienempiä vääntymiä, muoto säilyy parempana, ja vastaavasti lämpöhalkeamien ja kaasusulkeumien riski vähenee.

Suuremmalla taajuudella (keskimääräinen taajuus) saadaan kapeampi, lyhyempi ja vakaampi valokaari ja ohuiden materiaalien parantunut hitsaustulos.

Teräksen TIG-hitsaus

TIG-hitsaus on osoittautunut erittäin tehokkaaksi hitsattaessa sekä hiiliterästä että seostettua terästä, putkien ensimmäisissä palkoissa ja hitsauksissa, joissa ulkonäöllä on merkitystä. Vaaditaan hitsausta negatiivisilla navoilla (D.C.S.P)

Reunojen viimeistely

Toimenpide vaatii reunojen huolellisen puhdistuksen ja tarkan valmistelun.

Puikon valinta

On suositeltavaa käyttää torium-volframelektrodiä (2% punaista torium-väriä) tai vaihtoehtoisesti cerium- tai lantaanisekoitteisia elektrodeja, joiden läpimitat ovat seuraavat:

Ø elektrodi	Hitsausvirta
1.0 mm	15÷75 A
1.6 mm	60÷150 A
2.4 mm	130÷240 A

Puikko tulee teroittaa kuvan osoittamalla tavalla.

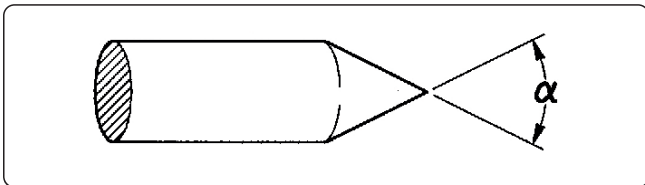

α°	Hitsausvirta
30	0÷30 A
60÷90	30÷120 A
90÷120	120÷250 A

Hitsausmateriaali

Hitsauspuikon ominaisuuksien on aina vastattava työkappaleen aineen ominaisuuksia.

Älä käytä työkappaleesta irrotettuja palasia lisäaineena, sillä ne saattavat sisältää epäpuhtauksia.

Suojakaasu

Suojakaasuna käytetään TIG-hitsauksessa käytännöllisesti katsoen vain puhdasta argonia (99.99%).

Hitsausvirta	Ø elektrodi	Kaasusuutin n°	Kaasusuutin	Argonvirtaus
30 A	0÷30 mm	4/5	6/8.0 mm	5-6 l/min
60÷90 A	30÷120 mm	4/5/6	6.5/8.0/9.5 mm	6-7 l/min
90÷120 A	120÷250 mm	6/7	9.5/11.0 mm	7-8 l/min

Kuparin TIG-hitsaus

Koska TIG-hitsausta luonnehtii korkea lämpötila, menetelmä soveltuu hyvin sellaisten materiaalien hitsaamiseen, joilla on hyvä lämmönjohtokyky, kuten kuparilla.

Kuparin TIG-hitsauksessa tulee noudattaa samoja ohjeita kuin teräksen TIG-hitsauksessa tai erityisohjeita.

9.3 Hitsauksesta lankaliittämällä (MIG/MAG)

Johdanto

MIG-järjestelmässä käytetään tasavirtageneraattoria, syöttökoneistoa ja puolaa, poltinta ja kaasua.

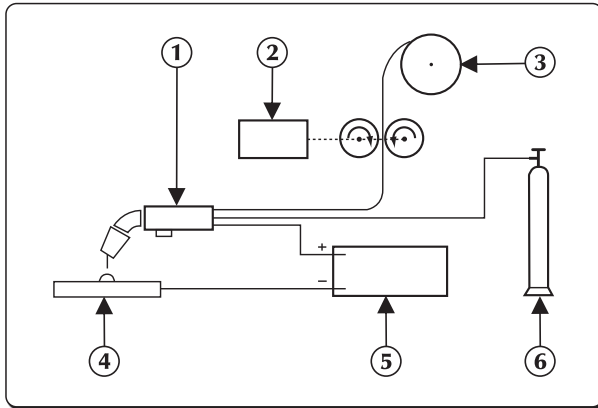

Manuaalinen hitsauslaite

Virta siirretään kaareen sulavan elektrodin kautta (lanka liitetty positiiviseen napaan);

Näin sulanut metalli siirtyy hitsattavaan palaan kaaren kautta.

Langan syöttö on tarpeellista sulaneen hitsausmateriaalin langan palauttamiseksi hitsauksen aikana.

Etenemistavat

Suojakaasulla hitsattaessa tapa, jolla pisarat irtoavat elektrodista, määrittelee kaksi eri siirtotapaa.

Ensimmäinen tapa, nimeltään "SIIRTO LYHYTKAARIHITSAUKSELLA (SHORT-ARC)", saattaa elektrodin suoraan kosketukseen hitsisulan kanssa. Näin syntyy lyhytkaari, joka aiheuttaa langan sulamisen. Tällöin lanka katkeaa, jonka jälkeen kaari käynnistyy uudelleen ja jakso toistuu.

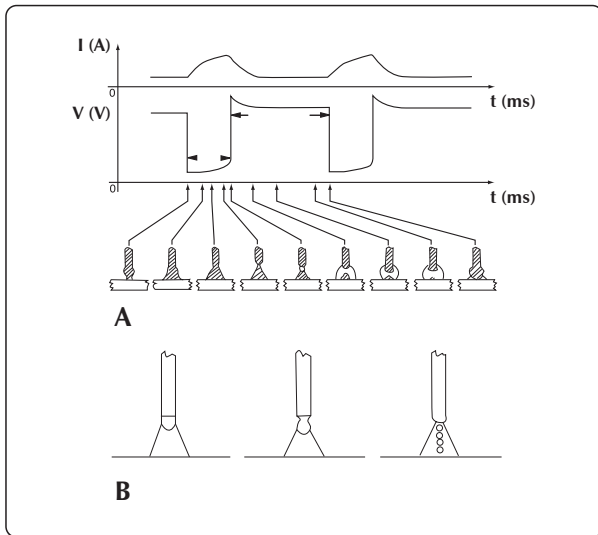

Jakso LYHYT (SHORT) ja hitsaus KUUMAKAARI (SPRAY ARC)

Toinen tapa siirtää roiskeita on "SIIRTO KUUMAKAARIHITSAUKSELLA (SPRAY-ARC)", joka mahdollistaa roiskeiden irtoamisen elektrodista ja sen jälkeen ne saavuttavat hitsisulan.

Hitsausparametrit



Kaaren näkyvyys vähentää käyttäjän tarvetta seurata jäykästi säätötaulukoita, koska hän pystyy suoraan tarkkailemaan hitsisulaa.

- Jännite vaikuttaa suoraan hitsauksen ulkonäköön, mutta hitsattavien pintojen mittasuhteet voidaan muuttaa tarpeen mukaan käyttäen poltinta manuaalisesti siten, että saadaan vaihtelevia kerrostumia vakaalla jännitteellä.
- Langan etenemisnopeus on suhteessa hitsausjännitteeseen.

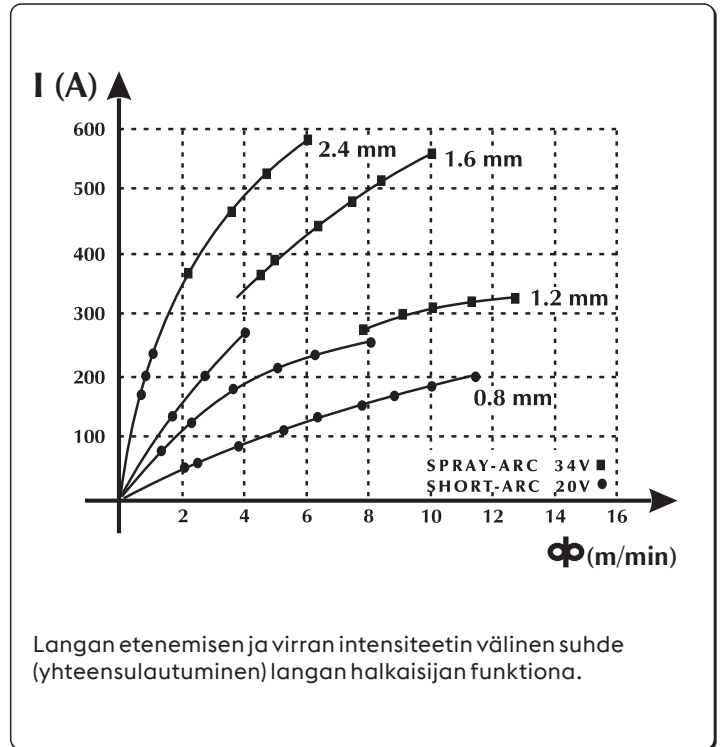
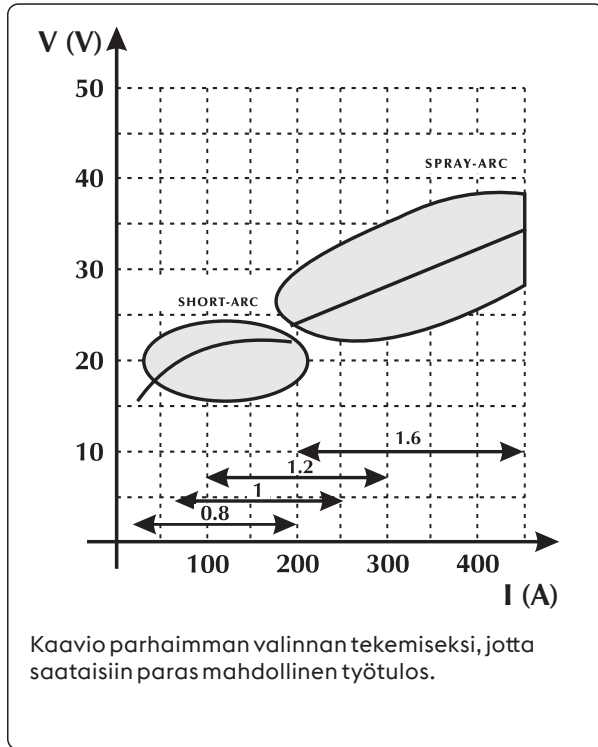
În cele două figuri de mai jos sunt arătate relațiile dintre diferiții parametri de sudare.

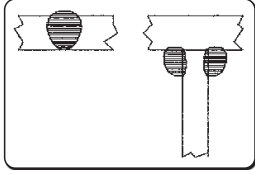
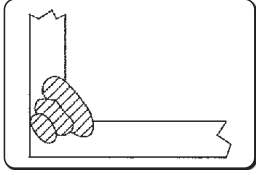
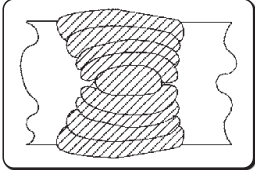

Opastava taulukko hitsausparametrien valitsemiseksi. tyypillisimmille sovelluksille ja yleisimmin käytetyille langoille

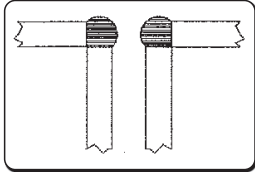
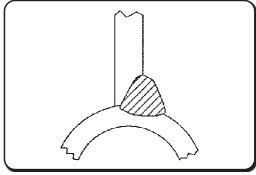
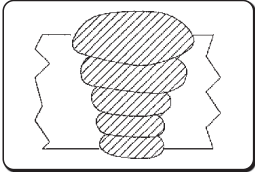
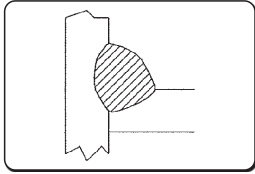
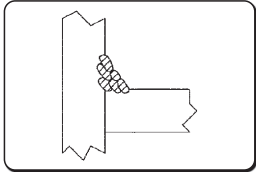
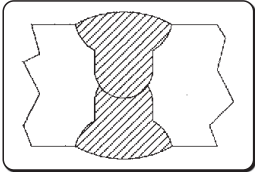
Kaaren jännite	Ø 0,8 mm	Ø 1,0-1,2 mm	Ø 1,6 mm	Ø 2,4 mm
16V - 22V SHORT - ARC				
	60 - 160 A Pienten kiilojen alhainen läpäisevyys	100 - 175 A Hyvä läpäisevyyden ja sulautumisen kontrolli	120 - 180 A Hyvä yhteensulautuminen vaak- ja pystysuunnassa	150 - 200 A Ei käytössä
	<hr/>			
	24V - 28V PUOLI LYHYTKAARI (SEMI SHORT-ARC) (Siirtoalue)			
150 - 250 A Kulmien automaattihitsaus		200 - 300 A Automaattinen hitsaus korkeajännitteellä	250 - 350 A Automaattinen hitsaus Ylhäältä alas	300 - 400 A Ei käytössä
<hr/>				
30V - 45V SPRAY - ARC				
	150 - 250 A Alhainen läpäisevyys 200 A säätelyllä	200 - 350 A Automaattihitsaus moniohituksella	300 - 500 A Hyvä läpäisevyys laskeutuessa	500 - 750 A Hyvä läpäisevyys, korkea tallennus suurille kiiloille

Käytettävät kaasut

MIG-MAG -hitsauksen ominaispiirteet syntyvät käytettävästä kaasusta. Ei käytössä MIG-hitsauksessa (Metal Inert Gas) ja käytössä MAG-hitsauksessa (Metal Active Gas).

- Hiilidioksidi (CO₂)

Käytettäessä hiilidioksidia suojakaasuna saadaan korkeat läpäisyt suurella etenemisnopeudella ja hyvät mekaaniset ominaisuudet halvoilla käyttökustannuksilla. Tämän kaasun käyttö tosin aiheuttaa ongelmia liitosten lopullisessa kemiallisessa palamisessa, johtuen helposti hapettuvien osien hävikistä, ja samalla tapahtuu hiilen rikastumista hitsisulaan. Hitsaus hiilidioksidilla aiheuttaa myös muita ongelmia, kuten liikaa roiskeita ja hiilidioksidin aiheuttamaa huokoisuutta.

- Argon

Tätä kaasua käytetään ainoastaan hitsattaessa kevyitä seoksia, kun taas hitsattaessa krominikkelisiä hapettumattomia teräksiä suositellaan lisättäväksi happea ja hiilidioksidia 2%. Tämä edesauttaa kaaren tasaisuutta ja antaa paremman muodon hitsaukselle.

- Helium

Tätä kaasua käytetään vaihtoehtona argonille ja mahdollistaa paremman läpäisevyyden (suurille kiiloille) ja nopeamman etenemisen.

- Argon-helium seos

Saadaan vakaampi kaari puhtaaseen heliumiin verrattuna, parempi läpäisevyys ja nopeus argoniin verrattuna.

- Argon- CO₂ ja Argon- CO₂ -Happi seos

Näitä seoksia käytetään hitsattaessa rautapitoisia tuotteita LYHYTKAARIHITSAUKSELLA (SHORT-ARC), koska ne parantavat hitsattavan materiaalin termisyyttä. Tämä ei poissulje käyttöä KUUMAKAARIHITSAUKSESSA (SPRAY-ARC).

Tavallisesti seos sisältää hiili-dioksidia 8% - 20% ja happea O₂ noin 5%.

Katso lisätietoja järjestelmän käyttöohjekirjasta.

10. TEKNISET OMINAISUUDET

Sähköiset ominaisuudet			U.M.
Syöttöjännite U1 (50/60 Hz)	3x230 (±15%)	3x400 (±15%)	Vac
Zmax (@PCC)*	62	62	mΩ
Hidastettu linjasulake	30	20	A
Tiedonsiirtoväylä	DIGITAALINEN	DIGITAALINEN	
Maksimi ottoteho	13.3	13.0	kVA
Maksimi ottoteho	12.8	12.4	kW
Ottoteho valmiustilassa	71	71	W
Tehokerroin (PF)	0.96	0.95	
Hyötysuhde (μ)	85	85	%
Cos φ	0.99	0.99	
Maksimi ottovirta I1max	32.9	18.8	A
Tehollinen virta I1eff	20.8	13.3	A
Säätöalue (MMA)	3-320	3-320	A
Tyhjäkäyntijännite Uo	75	75	Vdc





* Tämä laite ole standardin EN / IEC 61000-3-11 mukainen.

* Tämä laite täyttää standardin EN / IEC 61000-3-12 vaatimukset, jos liitäntä yleiseen sähköverkkoon tapahtuu pisteessä (PCC), jonka suurin impedanssi on pienempi tai yhtä suuri kuin ilmoitettu arvo "Zmax". Jos se kytketään julkiseen matalajänniteverkkoon, on laitteen asentajan tai käyttäjän vastuulla varmistaa, tarvittaessa yhdessä sähköyhtiön edustajan kanssa, että laitteen kytkeminen on luovallista.

Käyttökerroin	3x230V	3x400V	U.M.
Käyttökerroin MMA (40°C)			
(X=35%)	320	-	A
(X=50%)	-	320	A
(X=60%)	270	300	A
(X=100%)	230	250	A
Käyttökerroin MMA (25°C)			
(X=60%)	320	320	A
(X=100%)	270	270	A
Käyttökerroin TIG (40°C)			
(X=45%)	320	-	A
(X=60%)	300	320	A
(X=100%)	250	270	A
Käyttökerroin TIG (25°C)			
(X=70%)	320	320	A
(X=100%)	270	270	A
Käyttökerroin MIG/MAG (40°C)			
(X=35%)	320	-	A
(X=50%)	-	320	A
(X=60%)	280	310	A
(X=100%)	230	250	A
Käyttökerroin MIG/MAG (25°C)			
(X=60%)	320	-	A
(X=70%)	-	320	A
(X=100%)	270	270	A

Fyysiset ominaisuudet			U.M.
IP-luokitus	IP23S		
Eristysluokka	H		
Mitat (lxdxh)	620x240x460		mm
Paino	26.7		Kg
Standardit	EN IEC 60974-1/A1:2019 EN IEC 60974-3:2019 EN 60974-10/A1:2015		
Kappale syöttökaapeli	4x4		mm ²
Virtakaapelin pituus	5		m

11. ARVOKILPI

 VOESTALPINE BÖHLER WELDING SELCO S.R.L. Via Palladio, 19 - ONARA (PADOVA) - ITALY			
URANOS NX 3200 PME		N°	
 EN IEC 60974-1/A1:2019 60974-10/A1:2015 Class A			
3A/20.0V - 320A (320A)/32.8V (32.8V)			
X (40°C) 50% (35%) 60% 100%			
S	U ₀	I ₂	320A (320A) 300A (270A) 250A (230A)
	75V	U ₂	32.8V (32.8V) 32.0V (30.8V) 30.0V (29.2V)
3A/10.0V - 320A (320A)/22.8V (22.8V)			
X (40°C) (45%) 60% 100%			
S	U ₀	I ₂	(320A) 320A (300A) 270A (250A)
	75V	U ₂	(22.8V) 22.8V (22.0V) 20.8V (20.0V)
3A/14.0V - 320A (320A)/30.0V (30.0V)			
X (40°C) 50% (35%) 60% 100%			
S	U ₀	I ₂	320A (320A) 310A (280A) 250A (230A)
	75V	U ₂	30.0V (30.0V) 29.5V (28.5V) 26.5V (25.5V)
 U ₁ 400V(230V)		I _{1max} 18.8A(32.9A)	I _{1eff} 13.3A(20.8A)
IP 23 S			

12. KILVEN SISÄLTÖ

1		2			
3		4			
5		6			
7	9	23			
		11			
8	10	12	15	16	17
		13	15A	16A	17A
8	10	14	15B	16B	17B
		14	15B	16B	17B
7	9	11			
		12	15	16	17
8	10	13	15A	16A	17A
		14	15B	16B	17B
18	19	20	21		
22					

CE EU-vaatimustenmukaisuusvakuutus
 EAC EAC-vaatimustenmukaisuusvakuutus
 UKCA UKCA-vaatimustenmukaisuusvakuutus

- 1 Kaupallinen merkki
- 2 Valmistajan nimi ja osoite
- 3 Laitteen malli
- 4 Sarjanro
 XXXXXXXXXXXXX Valmistusvuosi
- 5 Hitsauskoneen tyypin symboli
- 6 Viittaus rakennestandardeihin
- 7 Hitsausprosessin symboli
- 8 Symboli, jonka mukaan hitsauskonetta voidaan käyttää ympäristössä, jossa on lisääntynyt sähköiskun vaara
- 9 Hitsausvirran symboli
- 10 Nimellistyhjäkäyntijännite
- 11 Nimellishitsausvirran sekä vastaavan tavanomaisen työjännitteen suurimmat ja pienimmät arvot
- 12 Katkohitsausjakson symboli
- 13 Nimellishitsausvirran symboli
- 14 Nimellishitsausjännitteen symboli
- 15 Katkohitsausjakson arvot
- 16 Katkohitsausjakson arvot
- 17 Katkohitsausjakson arvot
- 15A Nimellishitsausvirran arvot
- 16A Nimellishitsausvirran arvot
- 17A Nimellishitsausvirran arvot
- 15B Tavanomaisen työjännitteen arvot
- 16B Tavanomaisen työjännitteen arvot
- 17B Tavanomaisen työjännitteen arvot
- 18 Virtalähteen symboli
- 19 Nimellisliitäntäjännite
- 20 Suurin nimellisliitäntävirta
- 21 Suurin tehollisliitäntävirta
- 22 Suojausluokka
- 23 Nimellishuippujännite

ΔΗΛΩΣΗ ΣΥΜΜΟΡΦΩΣΗΣ ΕΥ

Ο οικοδόμος

voestalpine Böhler Welding Selco S.r.l. - Via Palladio, 19 - 35019 Onara di Tombolo (PD) - ITALY
Tel. +39 049 9413/111 - Fax +39 049 9413/311 - www.voestalpine.com/welding

δηλώνει με αποκλειστική ευθύνη ότι το ακόλουθο προϊόν:

URANOS NX 3200 PME

55.03.066

55.03.070

είναι κατασκευασμένη σε συμμόρφωση με τις Ευρωπαϊκές Οδηγίες:

2014/35/EU LOW VOLTAGE DIRECTIVE

2014/30/EU EMC DIRECTIVE

2011/65/EU RoHS DIRECTIVE

και ότι έχουν εφαρμοστεί τα ακόλουθα εναρμονισμένα πρότυπα:

EN IEC 60974-1/A1:2019

WELDING POWER SOURCE

EN 60974-10/A1:2015

ELECTROMAGNETIC COMPATIBILITY REQUIREMENTS

Η τεκμηρίωση που πιστοποιεί τη συμμόρφωση με τις οδηγίες θα παραμείνει διαθέσιμη για επιθεωρήσεις στον προαναφερόμενο κατασκευαστή.

Τυχόν επεμβάσεις ή τροποποιήσεις που θα γίνουν χωρίς την εξουσιοδότηση της voestalpine Böhler Welding Selco S.r.l., θα προκαλέσουν την παύση ισχύος της παραπάνω δήλωσης.

Onara di Tombolo, 15/10/2021

voestalpine Böhler Welding Selco s.r.l.

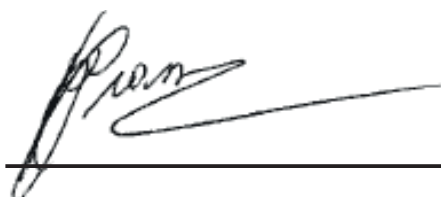

Lino Frasson

ΠΕΡΙΕΧΟΜΕΝΑ

1. ΠΡΟΕΙΔΟΠΟΙΗΣΕΙΣ.....	513
1.1 Περιβάλλον χρήσης	513
1.2 Ατομική προστασία και ασφάλεια τρίτων	513
1.3 Προστασία από καπνούς και αέρια	514
1.4 Πρόληψη πυρκαγιάς/έκρηξης	514
1.5 Προληπτικά μέτρα για τη χρήση φιαλών αερίου	515
1.6 Προστασία από ηλεκτροπληξία	515
1.7 Ηλεκτρομαγνητικά πεδία και παρεμβολές	515
1.8 Βαθμός προστασίας IP	516
1.9 Διάθεση.....	516
2. ΕΓΚΑΤΑΣΤΑΣΗ	517
2.1 Τρόπος ανύψωσης, μεταφοράς και εκφόρτωσης	517
2.2 Τοποθέτηση της διάταξης	517
2.3 Σύνδεση.....	517
2.4 Θέση σε λειτουργία.....	518
3. ΠΑΡΟΥΣΙΑΣΗ ΤΗΣ ΔΙΑΤΑΞΗΣ.....	520
3.1 Πίσω πάνελ	520
3.2 Πίνακας υποδοχών	520
3.3 Μπροστινός πίνακας ελέγχου	520
3.4 Μπροστινός πίνακας ελέγχου	521
4. ΧΡΗΣΗ ΤΟΥ ΕΞΟΠΛΙΣΜΟΥ.....	522
4.1 Σελίδα εκκίνησης	522
4.2 Σελίδα τεστ	522
4.3 Αρχική σελίδα	523
4.4 Κεντρική οθόνη διαδικασίας MMA	523
5. SETUP	530
5.1 Set up και τη ρύθμιση των παραμέτρων.....	530
5.2 Ειδικές διαδικασίες χρήσης των παραμέτρων	539
6. ΣΥΝΤΗΡΗΣΗ	543
6.1 Περιοδικοί έλεγχοι.....	544
6.2 Ευθύνη	544
7. ΚΩΔΙΚΟΙ ΣΥΝΑΓΕΡΜΩΝ (ΑΛΑΡΜ)	544
8. ΔΙΑΓΝΩΣΗ ΠΡΟΒΛΗΜΑΤΩΝ ΚΑΙ ΛΥΣΕΙΣ	546
9. ΣΥΝΤΟΜΗ ΑΝΑΦΟΡΑ ΣΤΗ ΘΕΩΡΙΑ ΤΗΣ ΣΥΓΚΟΛΛΗΣΗΣ	550
9.1 Συγκόλληση με επενδυμένο ηλεκτρόδιο (MMA)	550
9.2 Συγκόλληση TIG (συνεχές τόξο).....	551
9.3 Συγκόλλησης με συνεχές συρμα (mig/mag)	552
10. ΤΕΧΝΙΚΑ ΧΑΡΑΚΤΗΡΙΣΤΙΚΑ.....	555
11. ΠΙΝΑΚΙΔΑ ΧΑΡΑΚΤΗΡΙΣΤΙΚΩΝ	556
12. ΣΗΜΑΣΙΑ ΠΙΝΑΚΙΔΑΣ ΧΑΡ ΑΚΤΗΡΙΟΤΙΚΩΝ.....	556
13. ΔΙΑΓΡΑΜΜΑ	557
14. ΣΥΝΔΕΤΗΡΕΣ	559
15. ΚΑΤΑΛΟΓΟΣ	560

ΣΥΜΒΟΛΑ



Άμεσοι κίνδυνοι που προκαλούν σοβαρούς τραυματισμούς ή επικίνδυνες ενέργειες που μπορούν να προκαλέσουν σοβαρούς τραυματισμούς.



Ενέργειες που μπορούν να προκαλέσουν μη σοβαρούς τραυματισμούς ή βλάβες σε αντικείμενα.



Οι σημειώσεις που ακολουθούν αυτό το σύμβολο, έχουν τεχνικό χαρακτήρα και διευκολύνουν τις ενέργειες.

1. ΠΡΟΕΙΔΟΠΟΙΗΣΕΙΣ



Πριν προβείτε σε οποιαδήποτε ενέργεια, πρέπει να διαβάσετε και να είστε βέβαιοι ότι κατανοήσατε το παρόν εγχειρίδιο. Μην κάνετε μετατροπές και ενέργειες συντήρησης που δεν περιγράφονται στο παρόν. Ο κατασκευαστής δε φέρει καμία ευθύνη για τυχόν βλάβες, σε πρόσωπα ή πράγματα, που οφείλονται σε πλημμελή ανάγνωση και/ή μη εφαρμογή των οδηγιών του παρόντος εγχειριδίου.

Διατηρείτε πάντα τις οδηγίες χρήσης στον τόπο χρήσης της συσκευής. Εκτός από τις οδηγίες χρήσης, τηρείτε τους γενικούς κανόνες και τους ισχύοντες τοπικούς κανονισμούς για την πρόληψη των ατυχημάτων και την προστασία του περιβάλλοντος.



Όλοι οι υπεύθυνοι για τη θέση σε λειτουργία, τη χρήση, τη συντήρηση και την επισκευή της συσκευής πρέπει:

- να διαθέτουν κατάλληλη εξειδίκευση
- να διαθέτουν τις αναγκαίες δεξιότητες για τις συγκολλήσεις
- να έχουν διαβάσει πλήρως και να τηρούν σχολαστικά τις παρούσες οδηγίες χρήσης

Για κάθε αμφιβολία ή πρόβλημα σχετικά με τη χρήση της διάταξης, έστω κι αν δεν περιγράφεται εδώ, συμβουλευτείτε κάποιον εξειδικευμένο τεχνικό.

1.1 Περιβάλλον χρήσης



Κάθε διάταξη πρέπει να χρησιμοποιείται αποκλειστικά και μόνο για τις λειτουργίες που σχεδιάστηκε, με τους τρόπους και το εύρος τιμών που αναγράφονται στην πινακίδα χαρακτηριστικών και/ή στο παρόν εγχειρίδιο, και σύμφωνα με τους εθνικούς και διεθνείς κανονισμούς ασφαλείας. Οποιαδήποτε άλλη χρήση, που διαφέρει από αυτές που δηλώνει ρητά ο Κατασκευαστής, θεωρείται απολύτως ανάρμοστη και επικίνδυνη, και, στην περίπτωση αυτή, ο Κατασκευαστής δε φέρει καμία ευθύνη.



Η συσκευή πρέπει να προορίζεται μόνο για επαγγελματική χρήση, σε βιομηχανικό περιβάλλον. Ο κατασκευαστής δε φέρει καμία ευθύνη για βλάβες που ενδεχομένως προκληθούν εξαιτίας της χρήσης της διάταξης μέσα σε κατοικίες.



Η διάταξη πρέπει να χρησιμοποιείται σε χώρους με θερμοκρασία μεταξύ -10°C και $+40^{\circ}\text{C}$ ($+14^{\circ}\text{F}$ και $+104^{\circ}\text{F}$).

Η διάταξη πρέπει να μεταφέρεται και να αποθηκεύεται σε χώρους με θερμοκρασία μεταξύ -25°C και $+55^{\circ}\text{C}$ (-13°F και 131°F).

Η διάταξη πρέπει να χρησιμοποιείται σε περιβάλλον χωρίς σκόνη, οξέα, αέρια ή άλλες διαβρωτικές ουσίες.

Η διάταξη πρέπει να χρησιμοποιείται σε περιβάλλον με σχετική υγρασία μικρότερη του 50%, στους 40°C (104°F).

Η διάταξη πρέπει να χρησιμοποιείται σε περιβάλλον με σχετική υγρασία μικρότερη του 90%, στους 20°C (68°F).

Το μέγιστο επιτρεπόμενο υψόμετρο για τη χρήση της διάταξης είναι 2000 μ. (6500 πόδια).



Μη χρησιμοποιείτε αυτή τη συσκευή για να ξεπαγώνετε σωληνώσεις.

Μη χρησιμοποιείτε τη συσκευή για φόρτιση μπαταριών ή/και συσσωρευτών.

Μη χρησιμοποιείτε τη συσκευή για την εκκίνηση κινητήρων.

1.2 Ατομική προστασία και ασφάλεια τρίτων



Η διαδικασία συγκόλλησης αποτελεί πηγή βλαβερών ακτινοβολιών, θορύβου, θερμότητας και εκπομπής αερίων. Τοποθετήστε διαχωριστικό πυρίμαχο τοίχωμα, για να προστατευτεί η ζώνη συγκόλλησης από ακτίνες, σπινθήρες και πυρακτωμένα κομμάτια σκουριάς. Κάντε συστάσεις στους παρόντες να μην κοιτάζουν τη συγκόλληση και να προστατεύονται από τις ακτίνες του τόξου ή το πυρακτωμένο μέταλλο.



Φοράτε κατάλληλο ρουχισμό, που να προστατεύει το δέρμα από την ακτινοβολία του τόξου, τους σπινθήρες και/ή το πυρακτωμένο μέταλλο. Τα ρούχα που φοράτε πρέπει να καλύπτουν όλο το σώμα και πρέπει να είναι:

- Ακέραια και σε καλή κατάσταση
- Πυρίμαχα
- Μονωτικά και στεγνά
- Εφαρμοστά στο σώμα και χωρίς ρεβέρ



Φοράτε πάντοτε υποδήματα εγκεκριμένα σύμφωνα με τα σχετικά πρότυπα, ανθεκτικά και ικανά να εξασφαλίσουν τη μόνωση από το νερό.

Φοράτε πάντοτε γάντια, εγκεκριμένα με βάση τα σχετικά πρότυπα, που να εξασφαλίζουν την ηλεκτρική και θερμική μόνωση.



Για την προστασία των ματιών, χρησιμοποιείτε μάσκες με πλευρική προστασία για το πρόσωπο και κατάλληλο βαθμό προστασίας (B.Π. 10 ή ανώτερος).



Φοράτε πάντα προστατευτικά γυαλιά με πλευρικά καλύμματα, ειδικά κατά τις ενέργειες χειροκίνητης ή μηχανικής απομάκρυνσης της σκουριάς συγκόλλησης (κοπή).



Μη φοράτε φακούς επαφής!



Φοράτε ωτοασπίδες, σε περίπτωση που η διαδικασία συγκόλλησης παρουσιάζει επικίνδυνη στάθμη θορύβου. Αν η στάθμη θορύβου υπερβαίνει τα όρια του νόμου, οριοθετήστε τη ζώνη εργασίας και βεβαιωθείτε ότι οι παρόντες προστατεύονται με ωτοασπίδες ή ωτοβύσματα.



Διατηρείτε πάντα τα πλευρικά τοιχώματα κλειστά, κατά τη διάρκεια των εργασιών συγκόλλησης. Απαγορεύεται οποιαδήποτε μετατροπή της διάταξης.



Διατηρείτε πάντα τα πλευρικά τοιχώματα κλειστά, κατά τη διάρκεια των εργασιών συγκόλλησης. Αποφύγετε την επαφή χεριών, μαλλιών, ρούχων, εργαλείων... και κινούμενων εξαρτημάτων, όπως: ανεμιστήρες, γρανάζια, ράουλα και άξονες, καρούλια σύρματος. Μη επεμβαίνετε στους οδοντωτούς τροχούς (γρανάζια), όταν λειτουργεί ο τροφοδότης σύρματος. Απαγορεύεται οποιαδήποτε μετατροπή της διάταξης. Η απενεργοποίηση των προστατευτικών διατάξεων στους τροφοδότες σύρματος δημιουργεί μία εξαιρετικά επικίνδυνη κατάσταση και απαλλάσσει τον κατασκευαστή από κάθε ευθύνη για τυχόν βλάβες και ατυχήματα.



Κρατάτε το κεφάλι μακριά από την τσιμπίδα MIG/MAG, κατά τη διάρκεια της φόρτωσης και προώθησης του σύρματος. Το σύρμα, κατά την έξοδο, μπορεί να προκαλέσει σοβαρούς τραυματισμούς στα χέρια, στο πρόσωπο και στα μάτια.



Αποφύγετε την επαφή με κομμάτια, αμέσως μετά τη συγκόλληση. Η υψηλή θερμοκρασία μπορεί να προκαλέσει σοβαρά εγκαύματα.

Οι παραπάνω προφυλάξεις πρέπει να τηρούνται και στις εργασίες μετά τη συγκόλληση, γιατί μπορεί να αποκολλούνται κομμάτια σκουριάς από τα επεξεργασμένα κομμάτια που ψύχονται.



Πριν κάνετε κάποια ενέργεια πάνω στην τσιμπίδα ή προβείτε στη συντήρησή της, βεβαιωθείτε ότι έχει κρυώσει.



Πριν αποσυνδέσετε τους σωλήνες προσαγωγής και επιστροφής του ψυκτικού υγρού, βεβαιωθείτε ότι η μονάδα ψύξης είναι σβηστή. Το θερμό υγρό που βγαίνει μπορεί να προκαλέσει σοβαρά εγκαύματα.



Προμηθευτείτε τα απαραίτητα μέσα πρώτων βοηθειών. Μην παραμελείτε τυχόν εγκαύματα ή τραυματισμούς.



Πριν εγκαταλείψετε τη θέση εργασίας, πάρτε τα απαραίτητα μέτρα ασφαλείας, για να αποφευχθούν ακούσιες βλάβες και ατυχήματα.

1.3 Προστασία από καπνούς και αέρια



Οι καπνοί, τα αέρια και οι σκόνης που παράγονται από τη διαδικασία συγκόλλησης, μπορεί να αποδειχθούν επιβλαβή για την υγεία.

Υπό ορισμένες συνθήκες, οι καπνοί που παράγονται από τη συγκόλληση μπορεί να προκαλέσουν καρκίνο ή, στις έγκυες γυναίκες, βλάβες στο έμβρυο.

- Κρατάτε το κεφάλι μακριά από τα αέρια και τους καπνούς της συγκόλλησης.
- Η ζώνη εργασίας πρέπει να διαθέτει κατάλληλο σύστημα φυσικού ή βεβιασμένου αερισμού.
- Σε περίπτωση ανεπαρκούς αερισμού, χρησιμοποιήστε μάσκες με αναπνευστήρες.
- Σε περίπτωση συγκολλήσεων σε χώρους μικρών διαστάσεων, σας συνιστούμε την επίβλεψη του συγκολλητή από κάποιο συνάδελφο, που βρίσκεται έξω από το συγκεκριμένο χώρο.
- Μη χρησιμοποιείτε οξυγόνο για τον εξαερισμό.
- Για να ελέγχετε την αποτελεσματικότητα της αναρρόφησης, συγκρίνετε κατά περιόδους την ποσότητα των εκπομπών επιβλαβών αερίων με τις επιτρεπτές τιμές που αναγράφονται στους κανονισμούς ασφαλείας.
- Η ποσότητα και η επικινδυνότητα των παραγόμενων καπνών εξαρτάται από το βασικό υλικό που χρησιμοποιείται, από το υλικό συγκόλλησης και από ενδεχόμενες ουσίες που χρησιμοποιούνται για καθαρισμό και απολίπανση των κομματιών που συγκολλούνται. Ακολουθήστε πιστά τις οδηγίες του κατασκευαστή και των σχετικών τεχνικών δελτίων.
- Μην κάνετε συγκολλήσεις (κοπές) κοντά σε χώρους απολίπανσης ή βαφής.
- Τοποθετείτε τις φιάλες αερίου σε ανοικτούς χώρους ή σε χώρους με καλή κυκλοφορία του αέρα.

1.4 Πρόληψη πυρκαγιάς/έκρηξης



Η διαδικασία συγκόλλησης μπορεί να αποτελέσει αιτία πυρκαγιάς και/ή έκρηξης.

- Απομακρύνετε, από τη ζώνη εργασίας και τη γύρω περιοχή, τα εύφλεκτα ή καύσιμα υλικά και αντικείμενα.
- Τα εύφλεκτα υλικά πρέπει να βρίσκονται σε απόσταση τουλάχιστον 11 μέτρων (35 ποδιών) από το χώρο συγκόλλησης ή πρέπει να προστατεύονται κατάλληλα.
- Οι σπινθήρες και τα πυρακτωμένα σωματίδια που εκσφενδονίζονται μπορούν να φτάσουν εύκολα στις γύρω περιοχές ακόμη και από πολύ μικρά ανοίγματα. Προσέξτε ιδιαίτερα την ασφάλεια πραγμάτων και ατόμων.
- Μην κάνετε συγκολλήσεις πάνω ή κοντά σε δοχεία που βρίσκονται υπό πίεση.

- Μην εκτελείτε εργασίες συγκόλλησης σε κλειστά δοχεία ή σωλήνες. Επίσης, ιδιαίτερη προσοχή απαιτείται κατά τη συγκόλληση σωλήνων ή δοχείων, έστω και αν αυτά είναι ανοιχτά, άδεια και προσεκτικά καθαρισμένα. Τυχόν υπολείμματα αερίων, καυσίμων, λαδιού ή παρόμοιων ουσιών, μπορεί να προκαλέσουν εκρήξεις.
- Μην κάνετε συγκολλήσεις σε ατμόσφαιρα που περιέχει σκόνη, εκρηκτικά αέρια ή αναθυμιάσεις.
- Μετά τη συγκόλληση, βεβαιωθείτε ότι το ηλεκτρικό κύκλωμα δεν ακουμπά κατά λάθος σε επιφάνειες συνδεδεμένες με το κύκλωμα της γείωσης.
- Κοντά στη ζώνη εργασίας πρέπει να υπάρχει εξοπλισμός ή σύστημα πυρασφαλείας.

1.5 Προληπτικά μέτρα για τη χρήση φιαλών αερίου



Οι φιάλες αδρανούς αερίου περιέχουν αέριο υπό πίεση και μπορούν να εκραγούν, σε περίπτωση που δεν τηρούνται οι ελάχιστες συνθήκες ασφαλείας μεταφοράς, αποθήκευσης και χρήσης.

- Οι φιάλες πρέπει να είναι σταθερά στερεωμένες, σε κατακόρυφη θέση, πάνω σε τοίχους ή με άλλα κατάλληλα μέσα, για να αποφεύγονται πτώσεις ή τυχαία χτυπήματα.
- Βιδώνετε το κάλυμμα προστασίας της βαλβίδας κατά τη μεταφορά και την τοποθέτηση, καθώς και κάθε φορά που ολοκληρώνονται οι διαδικασίες συγκόλλησης.
- Αποφύγετε την έκθεση των φιαλών στην άμεση ηλιακή ακτινοβολία και σε απότομες μεταβολές θερμοκρασίας. Μην εκτίθετε τις φιάλες σε πολύ χαμηλές ή πολύ υψηλές θερμοκρασίες.
- Αποφύγετε την επαφή των φιαλών με ελεύθερες φλόγες, ηλεκτρικά τόξα, τσιμπίδες συγκόλλησης ή ηλεκτροδίων και πυρακτωμένων θραυσμάτων που παράγονται από τη συγκόλληση.
- Κρατήστε τις φιάλες μακριά από τα κυκλώματα συγκόλλησης και από ηλεκτρικά κυκλώματα γενικότερα.
- Κρατάτε το κεφάλι μακριά από το σημείο εξόδου του αερίου, όταν ανοίγετε τη βαλβίδα της φιάλης.
- Κλείνετε πάντα τη βαλβίδα της φιάλης, αφού ολοκληρώσετε τις εργασίες συγκόλλησης.
- Μην εκτελείτε ποτέ συγκολλήσεις σε φιάλες αερίου που βρίσκονται υπό πίεση.
- Μην συνδέετε ποτέ τη φιάλη πεπιεσμένου αέρα απευθείας στο μειωτήρα πίεσης του μηχανήματος! Η πίεση μπορεί να υπερβεί την ισχύ του μειωτήρα πίεσης και, κατά συνέπεια, να προκαλέσει έκρηξη!

1.6 Προστασία από ηλεκτροπληξία



Η ηλεκτροπληξία μπορεί να προκαλέσει θάνατο.

- Αποφύγετε την επαφή με τα σημεία που βρίσκονται συνήθως υπό τάση, στο εσωτερικό ή στο εξωτερικό της διάταξης συγκόλλησης, όταν η διάταξη έχει ρεύμα (οι τσιμπίδες, τα σώματα γείωσης, τα καλώδια γείωσης, τα ηλεκτρόδια, τα καλώδια, τα ράουλα και τα καρούλια συνδέονται με το ηλεκτρικό κύκλωμα συγκόλλησης).
- Εξασφαλίστε την ηλεκτρική μόνωση της εγκατάστασης και του χειριστή, χρησιμοποιώντας στεγνές επιφάνειες και βάσεις, με επαρκή μόνωση από το δυναμικό του εδάφους και της γείωσης.
- Βεβαιωθείτε ότι η εγκατάσταση συνδέεται σωστά, σε κάποια πρίζα και σε δίκτυο που διαθέτουν αγωγό γείωσης.
- Ο χειριστής δεν πρέπει να αγγίζει ταυτόχρονα δύο τσιμπίδες ηλεκτροδίων.
- Διακόψτε αμέσως τη συγκόλληση, εάν νιώσετε ότι σας διαπερνά ηλεκτρικό ρεύμα.

1.7 Ηλεκτρομαγνητικά πεδία και παρεμβολές



Η διέλευση του ρεύματος από τα εσωτερικά και εξωτερικά καλώδια της διάταξης, δημιουργεί ηλεκτρομαγνητικό πεδίο κοντά στα καλώδια συγκόλλησης και στην ίδια τη διάταξη.

- Τα ηλεκτρομαγνητικά πεδία μπορεί να έχουν (άγνωστες μέχρι σήμερα) επιπτώσεις στην υγεία, μετά από παρατεταμένη έκθεση.
- Τα ηλεκτρικά πεδία μπορούν να προκαλέσουν παρεμβολές σε άλλες ηλεκτρικές συσκευές, όπως στους βηματοδότες ή στα ακουστικά βαρηκοΐας.



Τα άτομα με ζωτικές ηλεκτρονικές συσκευές (βηματοδότες), πρέπει να συμβουλευθούν έναν ιατρό πριν πλησιάσουν κοντά σε εργασίες συγκόλλησης τόξου.

1.7.1 Ταξινόμηση ΗΜΣ σύμφωνα με το πρότυπο: EN 60974-10/A1:2015.



Η συσκευή κατηγορίας Β είναι κατασκευασμένη σε συμμόρφωση με τις απαιτήσεις συμβατότητας σε βιομηχανικούς χώρους ή κατοικίες, συμπεριλαμβανομένων των κατοικημένων περιοχών όπου η ηλεκτρική ενέργεια παρέχεται από κάποιο δημόσιο σύστημα χαμηλής τάσης.



Η συσκευή κατηγορίας Α δεν προορίζεται για χρήση σε κατοικημένες περιοχές όπου η ηλεκτρική ενέργεια παρέχεται από κάποιο δημόσιο σύστημα χαμηλής τάσης. Θα ήταν δυνητικά δύσκολο να εξασφαλιστεί η ηλεκτρομαγνητική συμβατότητα των συσκευών κατηγορίας Α σε αυτές τις περιοχές, εξαιτίας των παρεμβολών που εκπέμπονται και προσάγονται.

Δείτε το κεφάλαιο για περισσότερες πληροφορίες: ΠΙΝΑΚΊΔΑ ΧΑΡΑΚΗΤΗΡΙΣΤΙΚΩΝ ή ΤΕΧΝΙΚΑ ΧΑΡΑΚΗΤΗΡΙΣΤΙΚΑ.

1.7.2 Εγκατάσταση, χρήση και αξιολόγηση του χώρου

Η συσκευή αυτή κατασκευάζεται σύμφωνα με τις οδηγίες του εναρμονισμένου προτύπου EN 60974-10/A1:2015 και κατατάσσεται στην “ΚΑΤΗΓΟΡΙΑ Α”. Η συσκευή πρέπει να προορίζεται μόνο για επαγγελματική χρήση, σε βιομηχανικό περιβάλλον. Ο κατασκευαστής δε φέρει καμία ευθύνη για βλάβες που ενδεχομένως προκληθούν εξαιτίας της χρήσης της διάταξης μέσα σε κατοικίες.



Ο χρήστης πρέπει να έχει εμπειρία στον τομέα αυτό και θεωρείται υπεύθυνος για την εγκατάσταση και τη χρήση της συσκευής, σύμφωνα με τις οδηγίες του κατασκευαστή. Αν παρατηρηθούν ηλεκτρομαγνητικές παρεμβολές, ο χρήστης πρέπει να λύσει το πρόβλημα με την τεχνική υποστήριξη του κατασκευαστή.



Σε όλες τις περιπτώσεις, οι ηλεκτρομαγνητικές παρεμβολές πρέπει να ελαττωθούν έως το βαθμό στον οποίο που δεν προκαλούν ενόχληση.



Πριν την εγκατάσταση της συσκευής, ο χρήστης πρέπει να εκτιμήσει τα πιθανά ηλεκτρομαγνητικά προβλήματα που θα μπορούσαν να παρουσιαστούν στη γύρω ζώνη και ιδιαίτερα στην υγεία των παρόντων. Για παράδειγμα: άτομα με βηματοδότη (pace-maker) και ακουστικά βαρηκοΐας.

1.7.3 Απαιτήσεις τροφοδοσίας (βλ. τεχνικά χαρακτηριστικά)

Οι συσκευές υψηλής ισχύος θα μπορούσαν να επηρεάσουν την ποιότητα της ενέργειας του δικτύου διανομής, εξαιτίας του απορροφούμενου ρεύματος. Συνεπώς, για μερικούς τύπους συσκευών (βλ. τεχνικά χαρακτηριστικά) θα μπορούσαν να υφίστανται κάποιοι περιορισμοί σύνδεσης ή μερικές απαιτήσεις που αφορούν την μέγιστη επιτρεπόμενη εμπέδηση δικτύου (Z_{max}) ή την ελάχιστη ισχύ εγκατάστασης (S_{sc}) που διατίθεται στο σημείο διασύνδεσης με το δίκτυο (Σημείο Κοινής σύνδεσης ΣΚΣ - Point of Common Coupling PCC). Στην περίπτωση αυτή, ο εγκαταστάτης ή ο χρήστης έχουν την υποχρέωση να εξακριβώσουν (συμβουλευόμενοι ενδεχομένως τον διαχειριστή του ηλεκτρικού δικτύου) αν η συσκευή μπορεί να συνδεθεί. Σε περίπτωση παρεμβολών, μπορεί να είναι αναγκαία η λήψη πρόσθετων μέτρων, όπως η τοποθέτηση φίλτρων στο δίκτυο τροφοδοσίας.

Πρέπει επίσης να εκτιμήσετε αν είναι σκόπιμο να θωρακιστεί το καλώδιο τροφοδοσίας.

Δείτε το κεφάλαιο για περισσότερες πληροφορίες: ΤΕΧΝΙΚΑ ΧΑΡΑΚΤΗΡΙΣΤΙΚΑ.

1.7.4 Προληπτικά μέτρα σχετικά με τα καλώδια

Για την ελαχιστοποίηση των επιπτώσεων από τα ηλεκτρομαγνητικά πεδία, ακολουθείτε τους εξής κανόνες:

- Τυλίγεται και στερεώνεται μαζί, όπου αυτό είναι δυνατό, το καλώδιο γείωσης με το καλώδιο ισχύος.
- Αποφεύγετε το τύλιγμα των καλωδίων γύρω από το σώμα.
- Μη στέκεστε μεταξύ καλωδίου γείωσης και καλωδίου ισχύος (τα δύο καλώδια πρέπει να βρίσκονται από την ίδια πλευρά).
- Τα καλώδια πρέπει να έχουν το μικρότερο δυνατό μήκος, να τοποθετούνται κοντά μεταξύ τους και να μετακινούνται πάνω ή κοντά στην επιφάνεια του δαπέδου.
- Τοποθετείτε την διάταξη σε κάποια απόσταση από το σημείο συγκόλλησης.
- Τα καλώδια πρέπει να είναι τοποθετημένα μακριά από ενδεχόμενα άλλα καλώδια.

1.7.5 Ισοδυναμική σύνδεση (γείωση)

Πρέπει να εκτιμήσετε αν είναι απαραίτητη η γείωση όλων των μεταλλικών εξαρτημάτων της εγκατάστασης συγκόλλησης και της γύρω περιοχής. Τηρήστε τους τοπικούς τεχνικούς κανονισμούς περί ισοδυναμικής σύνδεσης (γείωσης).

1.7.6 γείωση του κατεργαζόμενου κομματιού

Όπου το υπό επεξεργασία κομμάτι δεν είναι γειωμένο, για λόγους ηλεκτρικής ασφαλείας ή εξαιτίας των διαστάσεων και της θέσης του, η σύνδεση γείωσης μεταξύ τεμαχίου και εδάφους μπορεί να μειώσει τις εκπομπές. Απαιτείται προσοχή, ώστε η γείωση του κατεργαζόμενου κομματιού να μην αυξάνει τον κίνδυνο ατυχήματος για το χειριστή ή να προκαλεί βλάβες σε άλλες ηλεκτρικές συσκευές. Τηρήστε τους τοπικούς τεχνικούς κανονισμούς περί ισοδυναμικής σύνδεσης (γείωσης).

1.7.7 Θωράκιση

Η επιλεκτική θωράκιση άλλων καλωδίων και συσκευών στη γύρω περιοχή μπορεί να μειώσει τα προβλήματα παρεμβολών.

Σε ειδικές εφαρμογές, θα μπορούσε να ληφθεί υπόψη η θωράκιση όλης της διάταξης συγκόλλησης.

1.8 Βαθμός προστασίας IP



IP23S

- Περίβλημα που αποτρέπει την τυχαία πρόσβαση σε επικίνδυνα μέρη κάποιου δάχτυλου ή κάποιου ξένου σώματος με διάμετρο ίση ή μεγαλύτερη από 12,5 mm.
- Περίβλημα προστατευμένο από βροχή που πέφτει με γωνία 60°.
- Περίβλημα που αποτρέπει τις βλαβερές συνέπειες της εισόδου νερού, όταν τα κινούμενα μέρη της συσκευής είναι ακίνητα.

1.9 Διάθεση



Μην απορρίπτετε την ηλεκτρική συσκευή με τα κοινά απόβλητα!

Σύμφωνα με την Ευρωπαϊκή Οδηγία 2012/19/ΕΕ σχετικά με τα απόβλητα ηλεκτρικού και ηλεκτρονικού εξοπλισμού, και για την εφαρμογή της βάσει της εθνικής νομοθεσίας, ο ηλεκτρικός εξοπλισμός που φτάνει στο τέλος του κύκλου ζωής του, πρέπει να συλλέγεται χωριστά και να παραδίδεται σε κέντρο ανάκτησης και διάθεσης. Ο ιδιοκτήτης της συσκευής οφείλει να αναζητήσει τα εξουσιοδοτημένα κέντρα συλλογής απευθυνόμενος στις τοπικές αρχές. Η εφαρμογή της Ευρωπαϊκής Οδηγίας θα επιτρέψει την καλύτερη προστασία του περιβάλλοντος και της υγείας του ανθρώπου.

2. ΕΓΚΑΤΑΣΤΑΣΗ



Η εγκατάσταση μπορεί να γίνει μόνο από έμπειρο προσωπικό, εξουσιοδοτημένο από τον κατασκευαστή.



Πριν την εγκατάσταση, βεβαιωθείτε ότι η γεννήτρια είναι αποσυνδεδεμένη από το ηλεκτρικό δίκτυο.



Απαγορεύεται η σύνδεση των γεννητριών (σε σειρά ή παράλληλα).

2.1 Τρόπος ανύψωσης, μεταφοράς και εκφόρτωσης

- Η διάταξη διαθέτει μια χειρολαβή, που επιτρέπει τη μετακίνησή της με το χέρι.
- Η διάταξη δεν διαθέτει ειδικά εξαρτήματα για την ανύψωση.
- Χρησιμοποιήστε ένα κλαρκ εκτελώντας προσεκτικά τη μετακίνηση, έτσι ώστε να αποφευχθεί η ανατροπή της γεννήτριας.



Μην υποτιμάτε το βάρος της διάταξης (βλ. τεχνικά χαρακτηριστικά).

Κατά την ανύψωση, κανένα άτομο δεν πρέπει να βρίσκεται κάτω από το φορτίο.

Αποφύγετε την πτώση της διάταξης και μην την αποθέτετε με δύναμη στο δάπεδο.

2.2 Τοποθέτηση της διάταξης



Τηρήστε τους εξής κανόνες:

- Εύκολη πρόσβαση στα όργανα ελέγχου και τις συνδέσεις.
- Μην τοποθετείτε τον εξοπλισμό σε στενούς χώρους.
- Μην τοποθετείτε ποτέ τη διάταξη πάνω σε μια επιφάνεια με κλίση μεγαλύτερη από 10° ως προς το οριζόντιο επίπεδο.
- Τοποθετήστε τη διάταξη σε χώρο στεγνό, καθαρό και με επαρκή εξαερισμό.
- Προστατέψτε τη διάταξη από τη βροχή και τον ήλιο.

2.3 Σύνδεση



Η γεννήτρια διαθέτει ηλεκτρικό καλώδιο, για τη σύνδεση στο δίκτυο τροφοδοσίας.

Η διάταξη μπορεί να τροφοδοτηθεί με ρεύμα:

- 400V τριφασικό
- 230V τριφασικό

Η λειτουργία της συσκευής είναι εγγυημένη για τάσεις με διακυμάνσεις έως $\pm 15\%$ επί της ονομαστικής τιμής (παράδειγμα: Vnom 400V, η τάση λειτουργίας κυμαίνεται μεταξύ 320V και 440V).



Για να αποφευχθούν ζημιές σε άτομα ή στην εγκατάσταση, πρέπει να ελέγξετε την επιλεγμένη τάση του δικτύου και τις ασφάλειες ΠΡΙΝ συνδέσετε το μηχάνημα στο ρεύμα. Επίσης πρέπει να βεβαιωθείτε ότι το καλώδιο είναι συνδεδεμένο σε μια πρίζα που διαθέτει γείωση.



Η εγκατάσταση μπορεί να τροφοδοτηθεί από ηλεκτροπαραγωγό ζεύγος αρκεί να εξασφαλίζει σταθερή τάση τροφοδοσίας μεταξύ $\pm 15\%$ ως προς την ονομαστική τιμή τάσης που δηλώνει ο κατασκευαστής σε όλες τις πιθανές συνθήκες χρήσης και με τη μέγιστη παρεχόμενη ισχύ της γεννήτριας. Κατά κανόνα, συνιστάται η χρήση ηλεκτροπαραγωγών ζευγών με ισχύ 2 φορές μεγαλύτερη από την ισχύ της γεννήτριας, για το μονοφασικό ρεύμα, και 1,5 φορά, για το τριφασικό. Συνιστάται η χρήση ηλεκτροπαραγωγών ζευγών με ηλεκτρονικό έλεγχο.



Για την προστασία των χειριστών, η διάταξη πρέπει να είναι σωστά γειωμένη. Το καλώδιο τροφοδοσίας διαθέτει έναν αγωγό (κίτρινο/πράσινος) για τη γείωση, που πρέπει να συνδεθεί σε ένα φισ με επαφή γείωσης. Ο κίτρινος/πράσινος αγωγός δεν πρέπει να χρησιμοποιείται ΠΟΤΕ μαζί με άλλο αγωγό για την παροχή τάσης. Ελέγξτε την ύπαρξη γείωσης στην εγκατάσταση και την καλή κατάσταση της πρίζας του ρεύματος. Χρησιμοποιείτε μόνο φισ που τηρούν τους κανονισμούς ασφαλείας.



Η ηλεκτρική εγκατάσταση πρέπει να γίνει από διπλωματούχο ηλεκτρολόγο και σύμφωνα με τους νόμους της χώρας όπου γίνεται η εγκατάσταση.

2.4 θέση σε λειτουργία

2.4.1 Σύνδεση για συγκόλληση MMA



Η σύνδεση που απεικονίζεται έχει σαν αποτέλεσμα συγκόλληση με ανάστροφη πολικότητα. Για να εκτελέσετε μία συγκόλληση με κανονική (άμεση) πολικότητα, αντιστρέψτε τη σύνδεση.

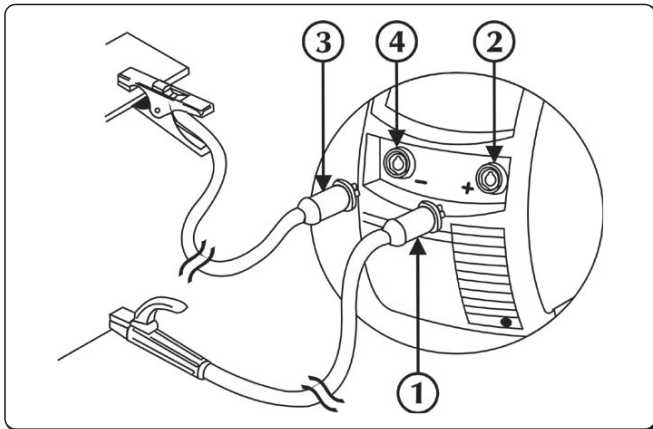

- ① Βύσμα τσιμπίδας γείωσης
- ② αρνητική υποδοχή ισχύος (-)
- ③ Βύσμα τσιμπίδας ηλεκτροδίου
- ④ θετική υποδοχή ισχύος (+)

- ▶ Συνδέστε το βύσμα του καλωδίου της τσιμπίδας σώματος στην αρνητική υποδοχή (-) της γεννήτριας. Βάλτε το βύσμα και γυρίστε δεξιόστροφα, έως ότου ασφαλίσουν τα δύο μέρη.
- ▶ Συνδέστε το βύσμα του καλωδίου της τσιμπίδας ηλεκτροδίου στην θετική υποδοχή (+) της γεννήτριας. Βάλτε το βύσμα και γυρίστε δεξιόστροφα, έως ότου ασφαλίσουν τα δύο μέρη.

2.4.2 Σύνδεση για συγκόλληση TIG

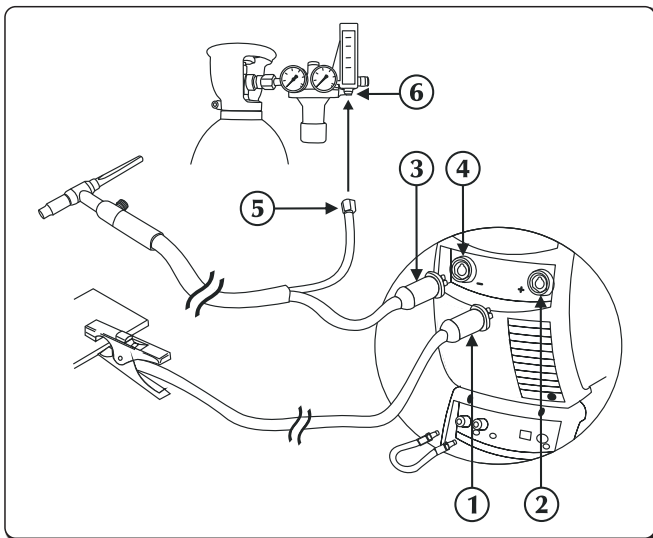



- ① Βύσμα τσιμπίδας γείωσης
- ② θετική υποδοχή ισχύος (+)
- ③ TTIG υποδοχή σύνδεσης τσιμπίδας
- ④ Υποδοχή φακού
- ⑤ Συνδετήρας σωλήνων αερίου
- ⑥ Μειωτήρα πίεσης

- ▶ Συνδέστε το βύσμα του καλωδίου της τσιμπίδας του σώματος στην θετική υποδοχή (+) της γεννήτριας. Βάλτε το βύσμα και γυρίστε δεξιόστροφα, έως ότου ασφαλίσουν τα δύο μέρη.
- ▶ Συνδέστε το βύσμα της τσιμπίδας TIG στις υποδοχή τσιμπίδας της γεννήτριας. Βάλτε το βύσμα και γυρίστε δεξιόστροφα, έως ότου ασφαλίσουν τα δύο μέρη.





Η ρύθμιση της παροχής του αερίου προστασίας επιτυγχάνεται ρυθμίζοντας τη βαλβίδα που συνήθως υπάρχει πάνω στην τσιμπίδα.

- ▶ Συνδέστε χωριστά το βύσμα του σωλήνα αερίου της τσιμπίδας στην παροχή αερίου.
- ▶ Συνδέστε το σωλήνα επιστροφής ψυκτικού υγρού της τσιμπίδας (κόκκινου χρώματος), στο ειδικό ρακόρ/σύνδεσμο (κόκκινου χρώματος - σύμβολο )
- ▶ Συνδέστε το σωλήνα προσαγωγής ψυκτικού υγρού της τσιμπίδας (μπλε χρώματος), στο ειδικό ρακόρ/σύνδεσμο (μπλε χρώματος - σύμβολο )

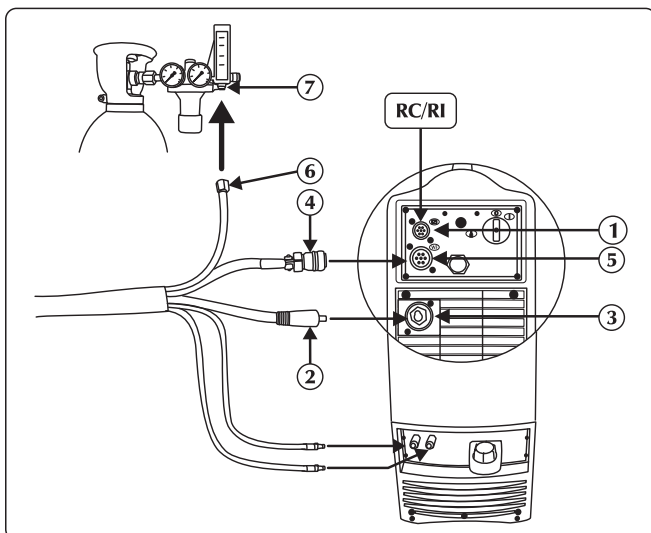
2.4.3 Σύνδεση για συγκόλληση MIG/MAG



- ① Είσοδος καλωδίου σήματος (CAN-BUS)
- ② Καλωδίου ισχύος
- ③ θετική υποδοχή ισχύος (+)
- ④ Καλώδιο σήματος
- ⑤ Είσοδος καλωδίου σήματος (CAN-BUS) (Δέσμη καλωδίων)
- ⑥ Σωλήνας αερίου
- ⑦ Ρακόρ τροφοδοσίας αερίου

- ▶ Συνδέστε το καλώδιο ισχύος της δέσμης καλωδίων στην ειδική υποδοχή. Βάλτε το βύσμα και γυρίστε δεξιόστροφα, έως ότου ασφαλίσουν τα δύο μέρη.
- ▶ Συνδέστε το καλώδιο σήματος, της δέσμης καλωδίων, στο ειδικό βύσμα σύνδεσης. Βάλτε το βύσμα και γυρίστε το δακτύλιο δεξιόστροφα, έως ότου ασφαλίσουν τα δύο μέρη.
- ▶ Συνδέστε το σωλήνα αερίου της δέσμης καλωδίων στο μειωτήρα πίεσης της φιάλης ή στο ρακόρ τροφοδοσίας αερίου. Ρυθμίστε τη ροή αερίου από 10 έως 30 λίτρα/λεπτό.
- ▶ Συνδέστε το σωλήνα προσαγωγής ψυκτικού υγρού, της δέσμης καλωδίων (μπλε χρώματος), στο ειδικό ρακόρ/σύνδεσμο (μπλε χρώματος - σύμβολο ).
- ▶ Συνδέστε το σωλήνα επιστροφής ψυκτικού υγρού, της δέσμης καλωδίων (κόκκινου χρώματος), στο ειδικό ρακόρ/σύνδεσμο (κόκκινου χρώματος - σύμβολο .

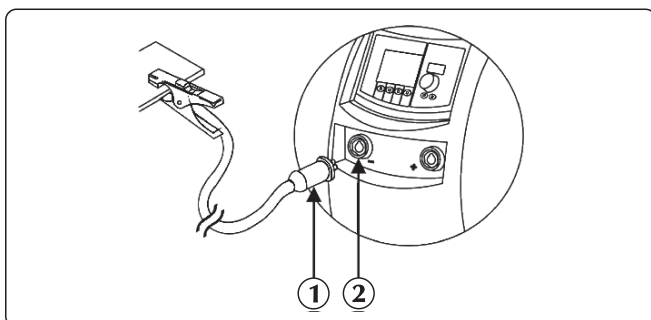

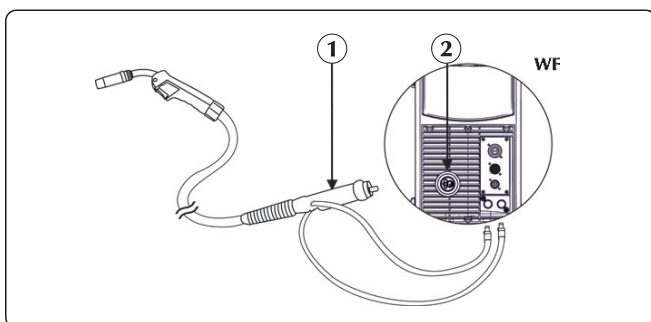

- ① Βύσμα τσιμπίδας γείωσης
- ② αρνητική υποδοχή ισχύος (-)

- ▶ Συνδέστε το βύσμα του καλωδίου της τσιμπίδας σώματος στην αρνητική υποδοχή (-) της γεννήτριας. Βάλτε το βύσμα και γυρίστε δεξιόστροφα, έως ότου ασφαλίσουν τα δύο μέρη.



- ① υποδοχή σύνδεσης τσιμπίδας
- ② Συνδετήρας

- ▶ Συνδέστε το σωλήνα προσαγωγής ψυκτικού υγρού της τσιμπίδας (μπλε χρώματος), στο ειδικό ρακόρ/σύνδεσμο (μπλε χρώματος - σύμβολο .
- ▶ Συνδέστε το σωλήνα επιστροφής ψυκτικού υγρού της τσιμπίδας (κόκκινου χρώματος), στο ειδικό ρακόρ/σύνδεσμο (κόκκινου χρώματος - σύμβολο .
- ▶ Συνδέστε την τσιμπίδα MIG/MAG στην υποδοχή, προσέχοντας ιδιαίτερα, ώστε να βιδώσετε εντελώς το δακτύλιο στερέωσης.

3. ΠΑΡΟΥΣΙΑΣΗ ΤΗΣ ΔΙΑΤΑΞΗΣ

3.1 Πίσω πάνελ

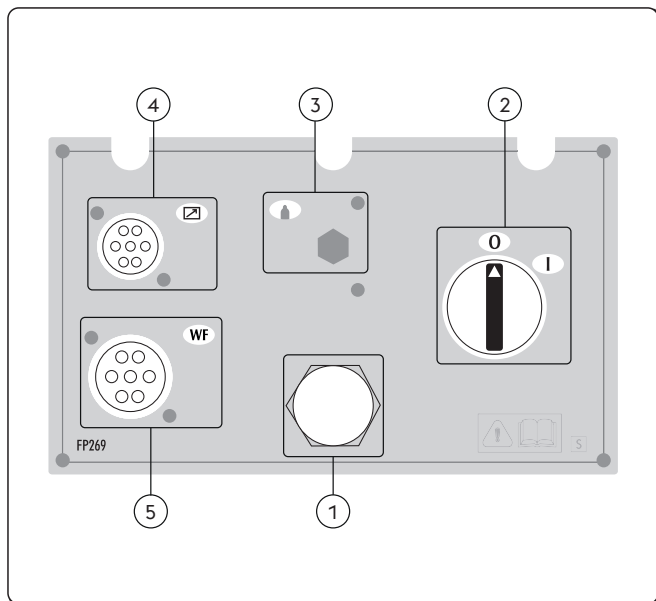

- ① καλώδιο τροφοδοσίας
Επιτρέπει την παροχή ρεύματος στη συσκευή, συνδέοντάς το με το δίκτυο.
- ② Διακόπτης ανάμματος
Ελέγχει την ηλεκτρική τροφοδοσία της μηχανής συγκόλλησης.
Διαθέτει δύο θέσεις: "0" σβηστό, "I" αναμμένο.
- ③ Δεν χρησιμοποιείται
- ④ Είσοδος καλωδίου σήματος CAN-BUS (RC, RI...)
- ⑤ Είσοδος καλωδίου σήματος (CAN-BUS) (Δέσμη καλωδίων)

3.2 Πίνακας υποδοχών

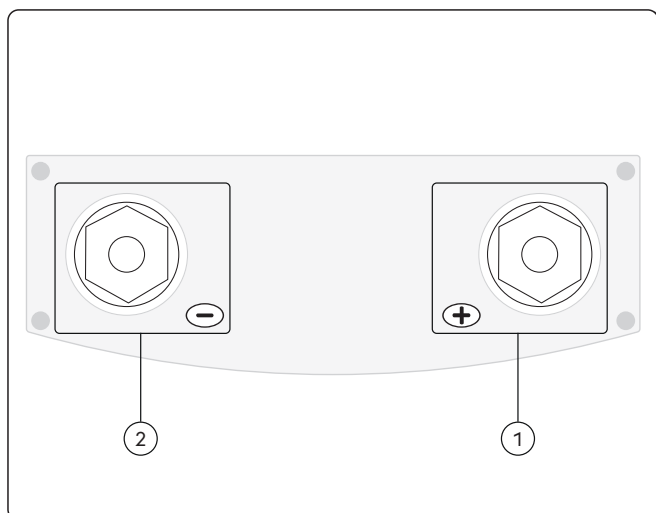

- ① θετική υποδοχή ισχύος (+)
Διαδικασία MMA: Σύνδεση φακό ηλεκτροδίου
Διαδικασία TIG: Σύνδεση καλωδίου γείωσης
- ② αρνητική υποδοχή ισχύος (-)
Διαδικασία MMA: Σύνδεση καλωδίου γείωσης
Διαδικασία TIG: Σύνδεση τσιμπίδα
Διαδικασία MIG/MAG: Σύνδεση καλωδίου γείωσης



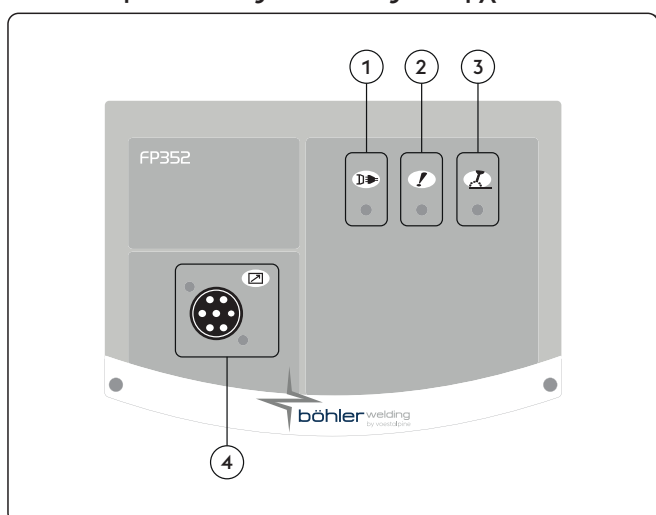



3.3 Μπροστινός πίνακας ελέγχου

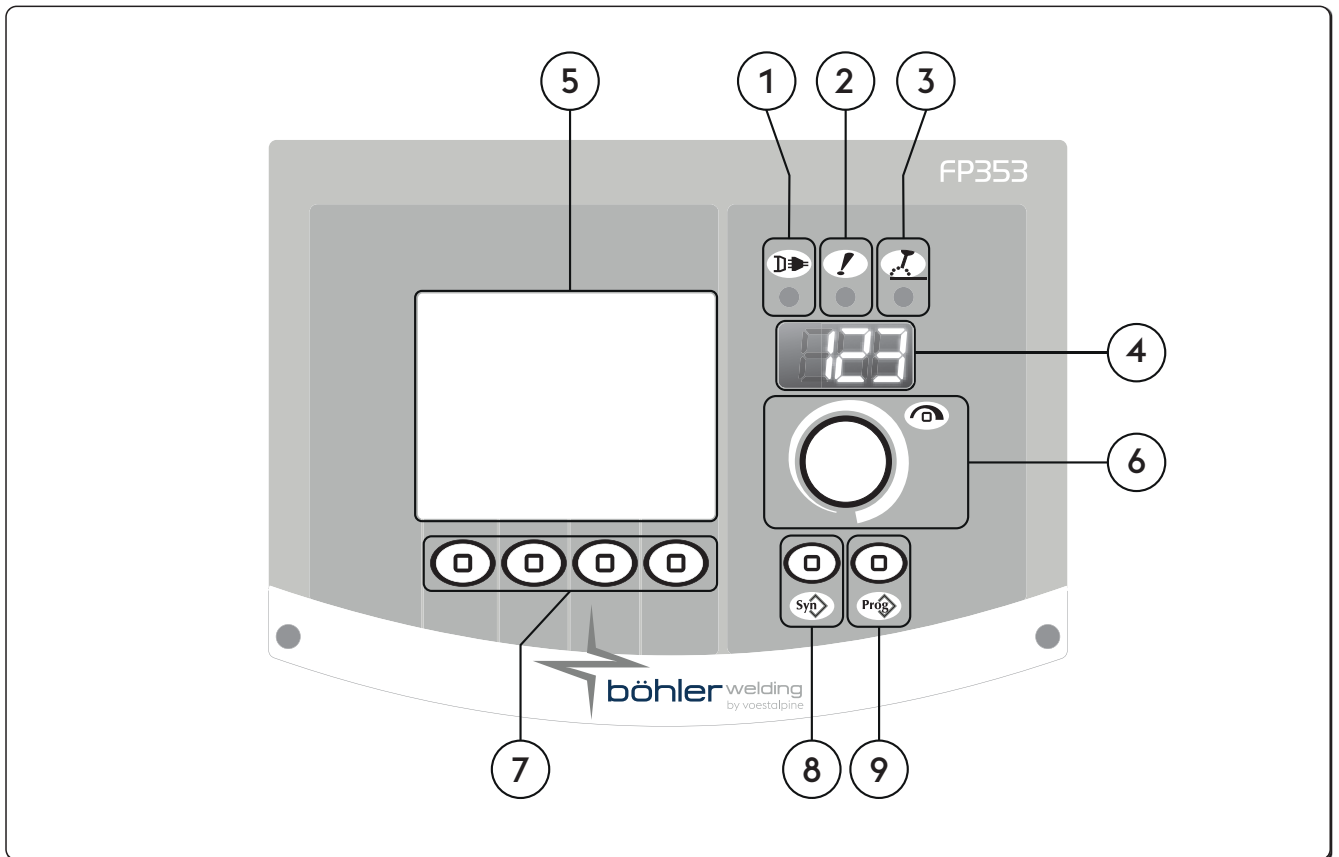

- ① LED τροφοδοσίας
Υποδεικνύει ότι η διάταξη είναι συνδεδεμένη με το δίκτυο και τροφοδοτείται κανονικά.
- ② LED γενικού συναγερμού
Υποδεικνύει ότι επενέβη κάποια διάταξη ασφαλείας (π.χ., θερμικό).
- ③ LED ενεργοποιημένης ισχύος
Υποδεικνύει την παρουσία τάσης στις υποδοχές εξόδου της διάταξης.
- ④ Είσοδος καλωδίου σήματος CAN-BUS (RC, RI...)

3.4 Μπροστινός πίνακας ελέγχου



- 1  LED τροφοδοσίας
Υποδεικνύει ότι η διάταξη είναι συνδεδεμένη με το δίκτυο και τροφοδοτείται κανονικά.
- 2  LED γενικού συναγερμού
Υποδεικνύει ότι επενέβη κάποια διάταξη ασφαλείας (π.χ., θερμικό).
- 3  LED ενεργοποιημένης ισχύος
Υποδεικνύει την παρουσία τάσης στις υποδοχές εξόδου της διάταξης.
- 4  Οθόνη 7 τμημάτων
Επιτρέπει την εμφάνιση των γενικών στοιχείων την μηχανής συγκόλλησης, κατά την εκκίνηση, τις ρυθμίσεις και τις καταγραφόμενες τιμές του ρεύματος και της τάσης, κατά τη συγκόλληση, καθώς και τους κωδικούς συναγερμού.
- 5  Οθόνη (LCD)
Επιτρέπει την εμφάνιση των γενικών στοιχείων την μηχανής συγκόλλησης, κατά την εκκίνηση, τις ρυθμίσεις και τις καταγραφόμενες τιμές του ρεύματος και της τάσης, κατά τη συγκόλληση, καθώς και τους κωδικούς συναγερμού. Επιτρέπει την άμεση εμφάνιση όλων των λειτουργιών.
- 6  Κύριος διακόπτης ρύθμισης
Επιτρέπει την είσοδο στο set up, την επιλογή και τη ρύθμιση των παραμέτρων συγκόλλησης.
- 7  Πλήκτρα λειτουργίας
Επιτρέπουν την επιλογή των διαφόρων λειτουργιών της διάταξης:
- Διαδικασία συγκόλλησης
- Τρόπος συγκόλλησης
- Παλμικότητα ρεύματος
- Γραφική απεικόνιση

- 8** **Syn** Πλήκτρο προγραμμάτων

Επιτρέπει την επιλογή του επιθυμητού προγράμματος συγκόλλησης, μέσω της εισαγωγής μερικών απλών πληροφοριών:

 - Τύπος σύρματος
 - Τύπος αερίου
 - Διάμετρος σύρματος
- 9** **Prog** Πλήκτρο job

Επιτρέπει την αποθήκευση στη μνήμη και τη διαχείριση 240 προγραμμάτων συγκόλλησης, τα οποία μπορούν να εξατομικευτούν από τον χειριστή.

4. ΧΡΗΣΗ ΤΟΥ ΕΞΟΠΛΙΣΜΟΥ

4.1 Σελίδα εκκίνησης

Με το άναμμα, η γεννήτρια εκτελεί μία σειρά αυτόματων ελέγχων, για να εξακριβώσει την ορθή λειτουργία του συστήματος και όλων των συσκευών που είναι συνδεδεμένες με αυτήν. Κατά το στάδιο αυτό πραγματοποιείται και το τεστ αερίου, για να διαπιστωθεί η σωστή σύνδεση του συστήματος τροφοδοσίας αερίου.

4.2 Σελίδα τεστ

Όταν το πλευρικό τοίχωμα (χώρος καρουλιού) είναι ανοιχτό, όλες οι ενέργειες συγκόλλησης απενεργοποιούνται. Στην οθόνη LCD εμφανίζεται η σελίδα των τεστ.

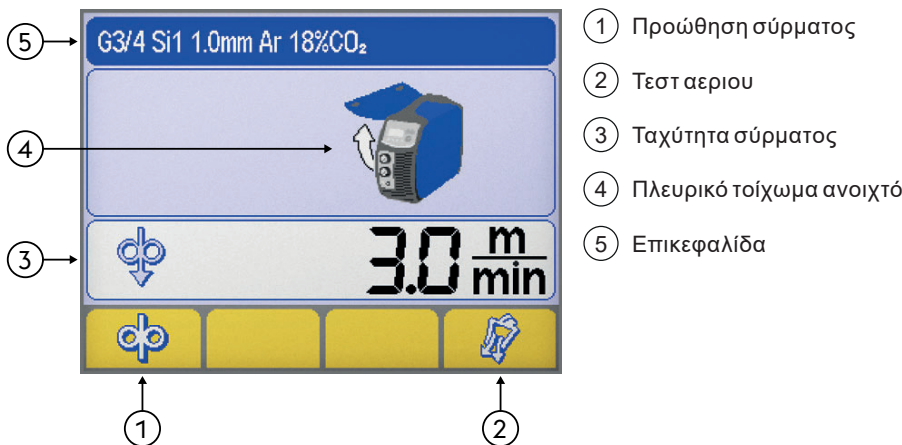

- 1** Προώθηση σύρματος

Επιτρέπει την χειροκίνητη προώθηση του σύρματος, χωρίς ροή αερίου και τάση στο σύρμα. Επιτρέπει την εισαγωγή του σύρματος μέσα στο περίβλημα της τσιμπίδας, κατά τα στάδια προετοιμασίας της συγκόλλησης.
- 2** Τεστ αερίου

Επιτρέπει την απομάκρυνση των ακαθαρσιών από το κύκλωμα του αερίου και την πραγματοποίηση, χωρίς ισχύ στην έξοδο, των απαραίτητων προκαταρκτικών ρυθμίσεων πίεσης και παροχής του αερίου.
- 3** Ταχύτητα σύρματος

Επιτρέπει τη ρύθμιση της ταχύτητας προώθησης του σύρματος (Κατά τη διάρκεια της φάσης φόρτωσης).

Ελάχιστη	Μέγιστη	Προκαθορισμ
0.5 m/min	22.0 m/min	3.0 m/min
- 4** Πλευρικό τοίχωμα ανοιχτό
- 5** Επικεφαλίδα

Εμφανίζει μερικές σημαντικές πληροφορίες που αφορούν τον επιλεγμένο τρόπο συγκόλλησης.

4.3 Αρχική σελίδα

Επιτρέπει τη διαχείριση της διάταξης και του τρόπου συγκόλλησης, με την εμφάνιση των βασικών ρυθμίσεων.

4.4 Κεντρική οθόνη διαδικασίας MMA

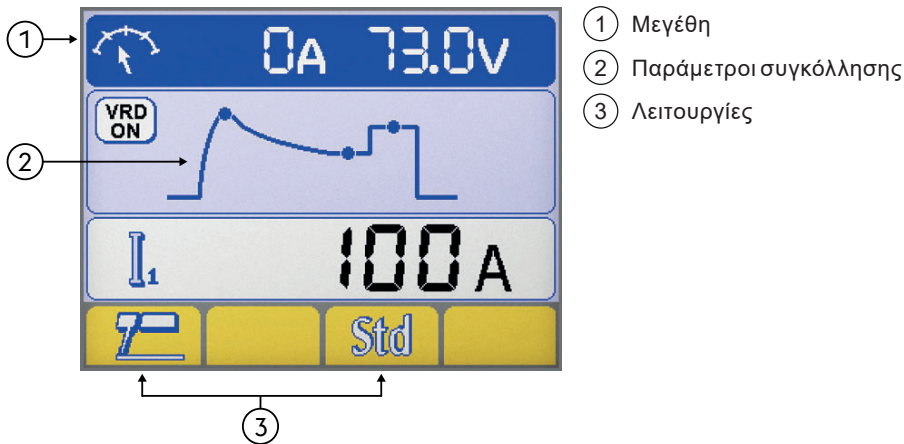

Μεγέθη

Κατά τα στάδια της συγκόλλησης, στην οθόνη LCD εμφανίζονται οι πραγματικές τιμές τάσης και ρεύματος.

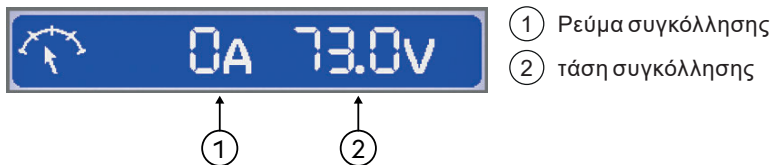

Παράμετροι συγκόλλησης

► Επιλέξτε την παράμετρο που θέλετε, πατώντας το πλήκτρο encoder.

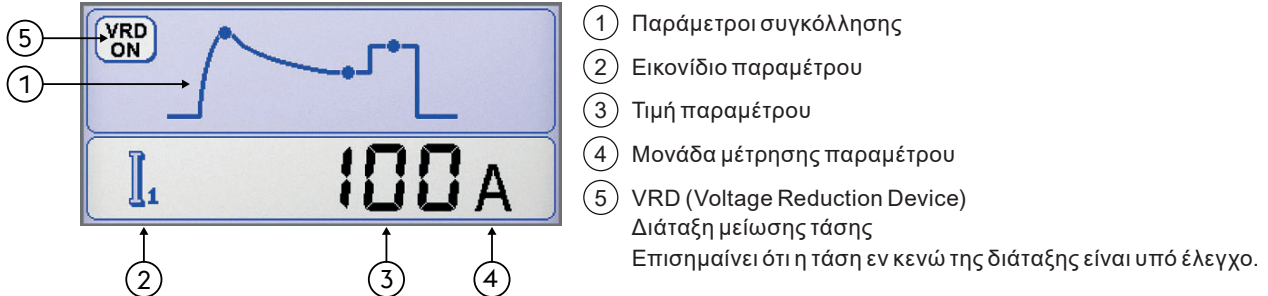

Λειτουργίες

Επιτρέπουν τη ρύθμιση της λειτουργικότητας των πιο σημαντικών τρόπων συγκόλλησης.



Διαδικασία συγκόλλησης





Συνεργία MMA

Επιτρέπει τη ρύθμιση της καλύτερης δυναμικής τόξου, επιλέγοντας τον τύπο του χρησιμοποιούμενου ηλεκτροδίου. Η επιλογή της σωστής δυναμικής τόξου επιτρέπει την πλήρη εκμετάλλευση των δυνατοτήτων της διάταξης και την επίτευξη της καλύτερης δυνατής απόδοσης στη συγκόλληση.

Standard (Βασικό/Ρουτιλίου)	Κυτταρίνης	Χάλυβα	Αλουμινίου	Χυτοσιδήρου

Δεν εξασφαλίζεται η τέλεια συγκολλητότητα του χρησιμοποιούμενου ηλεκτροδίου. Η συγκολλητότητα εξαρτάται από την ποιότητα των αναλώσιμων υλικών και από τον τρόπο αποθήκευσης/φύλαξής τους, από τις συνθήκες εργασίας και συγκόλλησης, από τις πολυάριθμες δυνατές εφαρμογές, κτλ.

4.5 Κεντρική οθόνη διαδικασίας TIG

Μεγέθη

Κατά τα στάδια της συγκόλλησης, στην οθόνη LCD εμφανίζονται οι πραγματικές τιμές τάσης και ρεύματος.

Παράμετροι συγκόλλησης

Λειτουργίες

Επιτρέπουν τη ρύθμιση της λειτουργικότητας των πιο σημαντικών τρόπων συγκόλλησης.

Διαδικασία συγκόλλησης

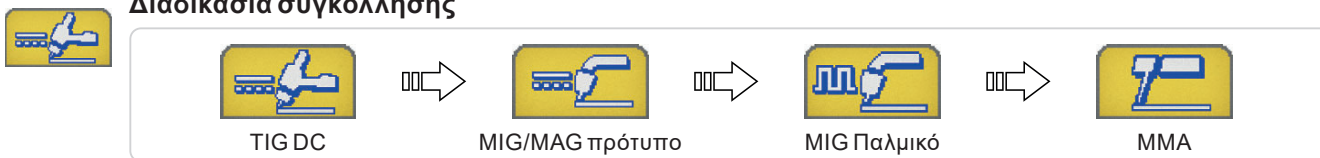

4.6 Κεντρική οθόνη διαδικασίας MIG/MAG

Βασική οθόνη

1) Επικεφαλίδα MIG/MAG
 2) Παράμετροι συγκόλλησης
 3) Λειτουργίες

Οθόνη γραφικών

1) Επικεφαλίδα MIG/MAG
 2) Παράμετροι συγκόλλησης
 3) Λειτουργίες

Επικεφαλίδα MIG/MAG

Εμφανίζει μερικές σημαντικές πληροφορίες που αφορούν τον επιλεγμένο τρόπο συγκόλλησης.

G3/4 Si1 1.0mm Ar 18%CO₂

- 1) 2) 3)

επιλεγμένη καμπύλη συνεργίας

- 1) Τύπος υλικού συγκόλλησης (κόλληση)
 2) Διάμετρος σύρματος
 3) Τύπος αερίου

I 118A 2.2mm 3.4mm V 19.5V

- 1) 2) 3) 4)

Παράμετροι συγκόλλησης

- 1) Ρεύμα συγκόλλησης
 2) Πάχος κομματιού
 3) Ραφή γωνίας
 4) τάση συγκόλλησης

Παράμετροι συγκόλλησης (Βασική οθόνη)

► Επιλέξτε την παράμετρο που θέλετε, πατώντας το πλήκτρο encoder.

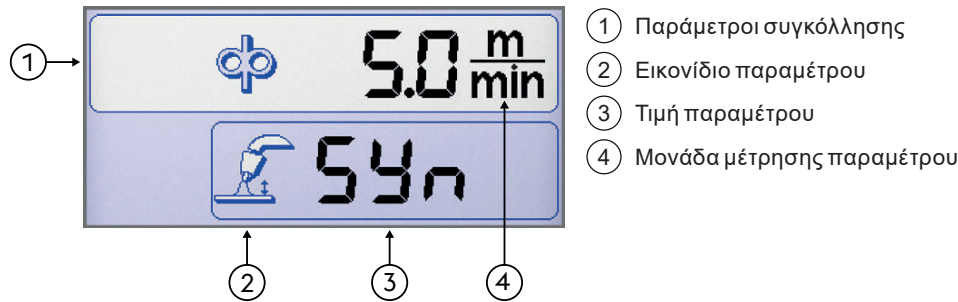

Παράμετροι συγκόλλησης (Οθόνη γραφικών)

► Επιλέξτε την παράμετρο που θέλετε, πατώντας το πλήκτρο encoder.

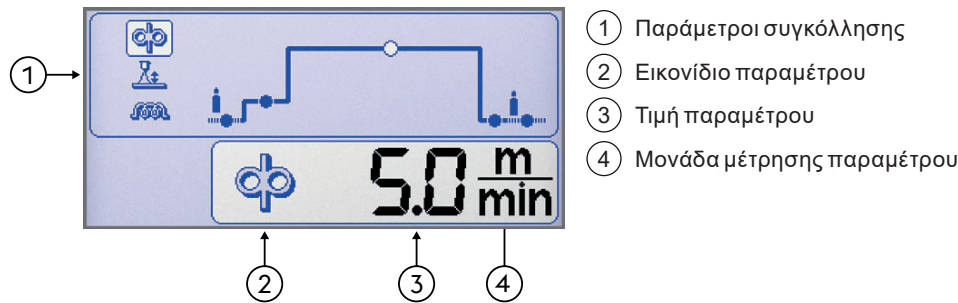

Λειτουργίες

Επιτρέπει τη ρύθμιση της λειτουργικότητας των πιο σημαντικών τρόπων συγκόλλησης.

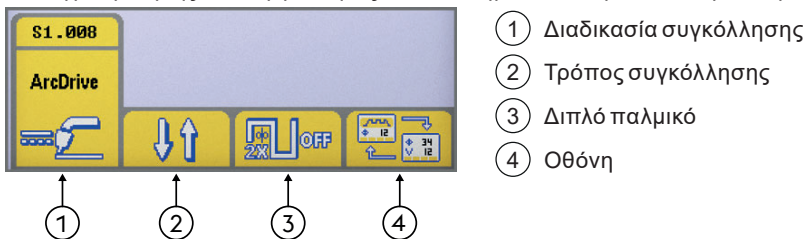

Διαδικασία συγκόλλησης

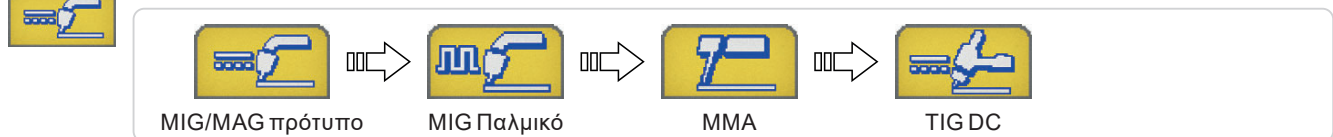

Τρόπος συγκόλλησης

Επιτρέπει την επιλογή του τρόπου συγκόλλησης



2 Χρόνοι

Σε δύο χρόνους, το πάτημα του πλήκτρου προκαλεί τη ροή του αερίου, ενεργοποιεί την τάση πάνω στο σύρμα και το προωθεί.

Μόλις αφεθεί, το αέριο, η τάση και η πρόωση του σύρματος απενεργοποιούνται.



4 Χρόνοι

Κατά τον τρόπο "4 Χρόνοι", το πρώτο πάτημα του πλήκτρου προκαλεί τη ροή του αερίου, πραγματοποιώντας ένα χειροκίνητο pre-gas. Μόλις αφεθεί, ενεργοποιείται η τάση στο σύρμα και η πρόωσή του. Με το επόμενο πάτημα του πλήκτρου, σταματάει το σύρμα και αρχίζει η τελική διαδικασία, που μηδενίζει το ρεύμα. Με την οριστική απελευθέρωση του πλήκτρου, σταματάει η ροή του αερίου.



Crater filler

Επιτρέπει την πραγματοποίηση μία συγκόλλησης με τρεις διαφορετικές κλίμακες ισχύος, η επιλογή και η διαχείριση των οποίων γίνεται απευθείας από το συγκολλητή, από το κουμπί της τσιμπιδας.

Με το πρώτο πάτημα του κουμπιού της τσιμπιδας αρχίζει η ροή αερίου, ενεργοποιείται η τάση πάνω στο σύρμα και αυτό προωθείται με την ταχύτητα που καθορίστηκε στην παράμετρο "αρχική αύξηση" (στο set up) και με τις σχετικές συνεργικές τιμές των παραμέτρων συγκόλλησης.

Μόλις αφεθεί το κουμπί της τσιμπιδας, η ταχύτητα σύρματος και οι σχετικές συνεργικές παράμετροι μεταβαίνουν αυτόματα στις αρχικές τιμές που καθορίστηκαν στον πίνακα ελέγχου.

Με το επόμενο πάτημα του κουμπιού της τσιμπιδας, η ταχύτητα σύρματος και οι σχετικές συνεργικές παράμετροι προσαρμόζονται στις τιμές που προκαθορίστηκαν στην παράμετρο (στο set up) crater filler.

Μόλις αφεθεί το κουμπί της τσιμπιδας, σταματάει η προώθηση του σύρματος και η παροχή ισχύος, και εκτελείται το burn back και το post gas.



Διπλό παλμικό



Διπλό παλμικό ΕΝΕΡΓΟ



Διπλό παλμικό ΜΗ ΕΝΕΡΓΟ

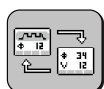

Οθόνη

Επιτρέπει την εναλλαγή μεταξύ των οθονών:



Βασική οθόνη



Οθόνη γραφικών

Σελίδα καμπυλών συνεργίας



Συνεργία

Επιτρέπει την επιλογή του επιθυμητού προγράμματος συγκόλλησης (συνεργία), μέσω της εισαγωγής μερικών απλών πληροφοριών

Επιλογή διαδικασίας συγκόλλησης



- ▶ Είσοδος στην οθόνη "συνεργική λειτουργία" πιέζοντας το πλήκτρο τουλάχιστον επί ένα δευτερόλεπτο.
- ▶ Επιλέξτε την επιθυμητή διαδικασία πιέζοντας τα πλήκτρα e .
- ▶ Πιέστε το πλήκτρο για μετάβαση στο επόμενο βήμα.



Διαδικασία συγκόλλησης

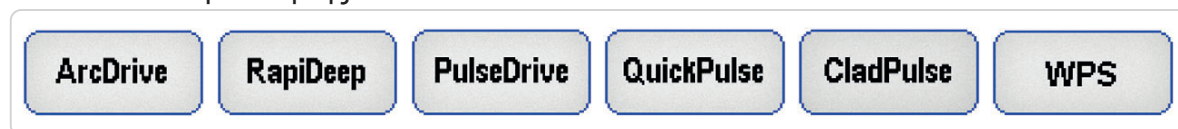

Οθόνη επιλογής συνδυασμού Τύπος υλικού/Τύπος αερίου

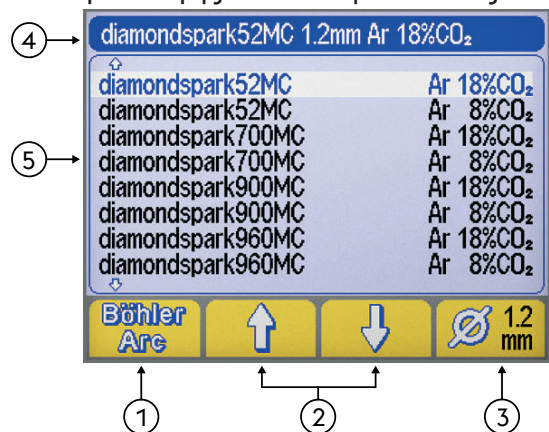

- 1 Προγράμματος συγκόλλησης (BöhlerArc/UniversalArc)
- 2 Επιλογή υλικού/αερίου
- 3 Διάμετρος σύρματος
- 4 Επικεφαλίδα
- 5 Προγράμματος συγκόλλησης



Προγράμματος συγκόλλησης

Επιτρέπει την επιλογή του προγράμματος συγκόλλησης



BöhlerArc



UniversalArc



Επιλογή υλικού/αερίου

Πατήστε το τμήμα:

- Τύπος υλικού συγκόλλησης (κόλληση)
- Τύπος αερίου



Διάμετρος σύρματος

Επιτρέπει την επιλογή της διαμέτρου του χρησιμοποιούμενου σύρματος (mm).

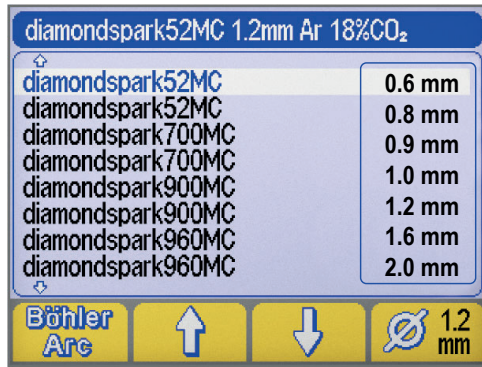

① Διάμετρος σύρματος



Επικεφαλίδα

Εμφανίζει μερικές σημαντικές πληροφορίες που αφορούν τον επιλεγμένο τρόπο συγκόλλησης.



NO PROGRAM

Σημαίνει ότι η καμπύλη συνεργίας που επιλέξατε δεν είναι διαθέσιμη ή δεν είναι συμβατή με τις άλλες ρυθμίσεις τις διατάξης.

4.7 Σελίδα προγραμμάτων



Επιτρέπει την αποθήκευση στη μνήμη και τη διαχείριση 240 προγραμμάτων συγκόλλησης, τα οποία μπορούν να εξατομικευτούν από τον χειριστή.

Προγράμματα (JOB)

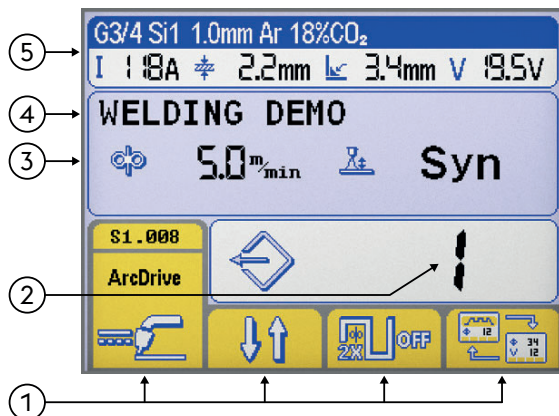

- ① Λειτουργίες
- ② Αριθμός του επιλεγμένου προγράμματος
- ③ Κύριες παράμετροι του επιλεγμένου προγράμματος
- ④ Περιγραφή του επιλεγμένου προγράμματος
- ⑤ Επικεφαλίδα

βλ. παράγραφο "Αρχική σελίδα"

Αποθήκευση προγράμματος στη μνήμη

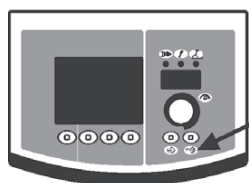

- ▶ Μπείτε στη σελίδα "αποθήκευση προγράμματος στη μνήμη", πατώντας το πλήκτρο. τουλάχιστον επί ένα δευτερόλεπτο.



- ▶ έξτε το πρόγραμμα (ή την κενή θέση μνήμης) που θέλετε, περιστρέφοντας το encoder.
- **Κενή θέση μνήμης**
- Πρόγραμμα αποθηκευμένο**
- ▶ Επιβεβαιώστε την ενέργεια, πατώντας το πλήκτρο .
- ▶ Αποθηκεύστε όλες τις τρέχουσες ρυθμίσεις μέσα στο επιλεγμένο πρόγραμμα, πατώντας το πλήκτρο. .

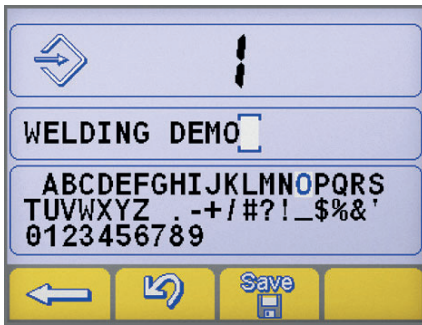

Εισάγετε μία περιγραφή του προγράμματος.

- ▶ Επιλέξτε το γράμμα που θέλετε, περιστρέφοντας το encoder.
- ▶ Αποθηκεύστε το γράμμα που θέλετε, πατώντας το encoder.
- ▶ Διαγράψτε το τελευταίο γράμμα, πατώντας το πλήκτρο
- ▶ Επιβεβαιώστε την ενέργεια, πατώντας το πλήκτρο
- ▶ Επιβεβαιώστε την ενέργεια, πατώντας το πλήκτρο

Όταν αποθηκεύεται ένα νέο πρόγραμμα σε μία ήδη κατειλημμένη θέση μνήμης, η μνήμη διαγράφεται μέσω μιας συγκεκριμένης διαδικασίας.



- ▶ Επιβεβαιώστε την ενέργεια, πατώντας το πλήκτρο
- ▶ Διαγράψτε το πρόγραμμα που επιλέξατε, πατώντας το πλήκτρο
- ▶ Συνεχίστε τη διαδικασία αποθήκευσης στη μνήμη.

Άνοιγμα προγραμμάτων

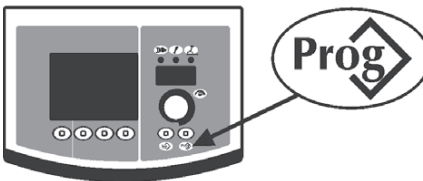

- ▶ Ανοίξτε το 1° διαθέσιμο πρόγραμμα, πατώντας το πλήκτρο, πατώντας το πλήκτρο
- ▶ Επιλέξτε το πρόγραμμα που θέλετε, περιστρέφοντας το encoder.
- ▶ Επιλέξτε το επιθυμητό πρόγραμμα, πατώντας το πλήκτρο

Εμφανίζονται μόνο οι θέσεις μνήμης που περιέχουν κάποιο πρόγραμμα (οι κενές θέσεις παραλείπονται αυτόματα).

Διαγραφή προγραμμάτων



- ▶ Επιλέξτε το πρόγραμμα που θέλετε, περιστρέφοντας το encoder.
- ▶ Διαγράψτε το πρόγραμμα που επιλέξατε, πατώντας το πλήκτρο
- ▶ Επιβεβαιώστε την ενέργεια, πατώντας το πλήκτρο

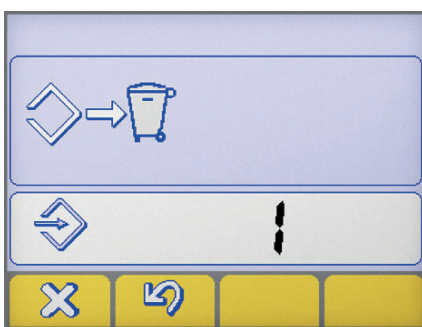

- ▶ Επιβεβαιώστε την ενέργεια, πατώντας το πλήκτρο
- ▶ Διαγράψτε το πρόγραμμα που επιλέξατε, πατώντας το πλήκτρο

5. SETUP

5.1 Set up και τη ρύθμιση των παραμέτρων

Επιτρέπει τον προγραμματισμό και τη ρύθμιση μιας σειράς πρόσθετων παραμέτρων, για καλύτερη και ακριβέστερη διαχείριση της διάταξης συγκόλλησης.

Οι παράμετροι που εμφανίζονται στο set up είναι οργανωμένες ως προς την επιλεγμένη διαδικασία συγκόλλησης και διαθέτουν αριθμητική κωδικοποίηση.

Είσοδος στο set up



- ▶ Επιτυγχάνεται πατώντας για 5 δευτερόλεπτα το πλήκτρο encoder.
- ▶ Η είσοδος επιβεβαιώνεται από την ένδειξη 0 στην οθόνη.

Επιλογή και ρύθμιση της επιθυμητής παραμέτρου

- ▶ Γυρίστε το encoder, έως ότου εμφανιστεί ο αριθμητικός κωδικός της επιθυμητής παραμέτρου.
- ▶ Στο σημείο αυτό, με το πάτημα του πλήκτρου encoder, εμφανίζεται η προγραμματισμένη τιμή και η ρύθμιση της επιλεγμένης παραμέτρου.

Έξοδος από το set up

- ▶ Για να βγείτε από τις “ρυθμίσεις”, πατήστε πάλι το πλήκτρο encoder.
- ▶ Για έξοδο από το set up επιλέξτε την παράμετρο “0” (αποθήκευση και έξοδος) και πατήστε το πλήκτρο encoder.
- ▶ Επιβεβαιώστε την ενέργεια, πατώντας το πλήκτρο .
- ▶ Για αποθήκευση της τροποποίησης και έξοδο από το set up πιάστε το κουμπί: .

5.1.1 Κατάλογος παραμέτρων set up (MMA)



0

Αποθήκευση και έξοδος

Επιτρέπει την αποθήκευση των αλλαγών και την έξοδο από το set up.

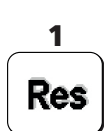

1

Επαναφέρω

Επιτρέπει την επαναφορά όλων των παραμέτρων στις προκαθορισμένες τιμές (default).



3

Hot start

Επιτρέπει τη ρύθμιση της τιμής hot start σε MMA.

Επιτρέπει την επιλογή περισσότερο ή λιγότερο “θερμής” εκκίνησης στις φάσεις έναυσης του τόξου, διευκολύνοντας τη διαδικασία εκκίνησης (start).

Ηλεκτρόδιο βασικό

Ελάχιστη	Μέγιστη	Προκαθορισμ
0/μακριά από	500%	80%

Ηλεκτρόδιο κυτταρίνης

Ελάχιστη	Μέγιστη	Προκαθορισμ
0/μακριά από	500%	150%

Ηλεκτρόδιο CrNi

Ελάχιστη	Μέγιστη	Προκαθορισμ
0/μακριά από	500%	100%

Ηλεκτρόδιο αλουμινίου

Ελάχιστη	Μέγιστη	Προκαθορισμ
0/μακριά από	500%	120%

Ηλεκτρόδιο χυτοσιδήρου

Ελάχιστη	Μέγιστη	Προκαθορισμ
0/μακριά από	500%	100%

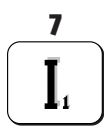

7

Ρεύμα συγκόλλησης

Επιτρέπει τη ρύθμιση του ρεύματος συγκόλλησης.

Ελάχιστη	Μέγιστη	Προκαθορισμ
3 A	I _{max}	100 A

8
Arc force

Επιτρέπει τη ρύθμιση της τιμής Arc force σε MMA.

Επιτρέπει την επιλογή περισσότερο ή λιγότερο έντονης δυναμικής απόκρισης στη συγκόλληση, διευκολύνοντας τις εργασίες του συγκολλητή.

Αυξήστε την τιμή του Arc force για να ελαττωθούν οι πιθανότητες να κολλήσει το ηλεκτρόδιο.

Ηλεκτρόδιο βασικό

Ελάχιστη	Μέγιστη	Προκαθορισμ
0/μακριά από	500%	30%

Ηλεκτρόδιο κυτταρίνης

Ελάχιστη	Μέγιστη	Προκαθορισμ
0/μακριά από	500%	350%

Ηλεκτρόδιο CrNi

Ελάχιστη	Μέγιστη	Προκαθορισμ
0/μακριά από	500%	30%

Ηλεκτρόδιο αλουμινίου

Ελάχιστη	Μέγιστη	Προκαθορισμ
0/μακριά από	500%	100%

Ηλεκτρόδιο χυτοσιδήρου

Ελάχιστη	Μέγιστη	Προκαθορισμ
0/μακριά από	500%	70%

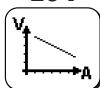
204
Dynamic power control (DPC)

Επιτρέπει την επιλογή του επιθυμητού χαρακτηριστικού V/I.

I=C Ρεύμα σταθερό

Η αυξομείωση του ύψους του τόξου δεν επηρεάζει καθόλου το παρεχόμενο ρεύμα συγκόλλησης.

Συνιστάται για ηλεκτρόδιο: Βασικό, Ρουτιλίου, Όξινη, Χάλυβα, Χυτοσιδήρου

1=20 Πτωτικό χαρακτηριστικό με ρύθμιση σταδιακής καθόδου (ράμπας)

Η αύξηση του ύψους του τόξου προκαλεί τη μείωση του ρεύματος συγκόλλησης (και αντίστροφα), ανάλογα με την τιμή ρύθμισης, από 1 έως 20 Ampere, ανά Volt.

Συνιστάται για ηλεκτρόδιο: Κυτταρίνης, Αλουμινίου

P=C Σταθερή ισχύς

 Η αύξηση του ύψους του τόξου προκαλεί την μείωση του ρεύματος συγκόλλησης (και αντίστροφα), με βάση τον κανόνα: $V \cdot I = K$

Συνιστάται για ηλεκτρόδιο: Κυτταρίνης, Αλουμινίου

312
Τάση βεβιασμένου σβησίματος τόξου

Επιτρέπει τον προγραμματισμό της τιμής τάσης στην οποία σβήνει βεβιασμένα το ηλεκτρικό τόξο.

Επιτρέπει την καλύτερη διαχείριση των διαφόρων συνθηκών λειτουργίας που παρουσιάζονται.

Για παράδειγμα, κατά το ποντάρισμα (σημειακή συγκόλληση), η χαμηλή τάση βεβιασμένου σβησίματος τόξου επιτρέπει μικρότερη φλόγα κατά την απομάκρυνση του ηλεκτροδίου από το κομμάτι, μειώνοντας τα πιπίλισματα, τα καψίματα και την οξειδωση του τεμαχίου.

Αντιθέτως, αν χρησιμοποιούνται ηλεκτρόδια που απαιτούν υψηλές τάσεις, σας συνιστούμε την επιλογή υψηλής τιμής, έτσι ώστε να αποφεύγεται το σβήσιμο του τόξου κατά τη συγκόλληση.

Μην επιλέγετε ποτέ μία τάση βεβιασμένου σβησίματος τόξου μεγαλύτερη από την τάση εν κενώ της γεννήτριας.
Ηλεκτρόδιο βασικό

Ελάχιστη	Μέγιστη	Προκαθορισμ
0/μακριά από	99.9 V	57.0 V

Ηλεκτρόδιο κυτταρίνης

Ελάχιστη	Μέγιστη	Προκαθορισμ
0/μακριά από	99.9 V	70.0 V

399
Ταχύτητα μετατόπισης

Επιτρέπει τη ρύθμιση της ταχύτητας εκτέλεσης της συγκόλλησης.

Default cm/min: ταχύτητα αναφοράς για τη χειροκίνητη συγκόλληση.

Syn: Sinergic αξία.

Ελάχιστη	Μέγιστη	Προκαθορισμ
1 cm/min	200 cm/min	15 cm/min

500
Προγραμματισμός μηχανήματος

Επιτρέπει την επιλογή της επιθυμητής γραφικής διεπαφής.

Επιτρέπει την πρόσβαση στα ανώτερα επίπεδα του set up.

βλ. παράγραφο "Εξατομίκευση οθόνης (Set up 500)"

Τιμή	Διεπαφή Χρήστη
XE	Τρόπος Easy
XA	Τρόπος Advanced
XP	Τρόπος Professional

Τιμή	Επιλεγμένο επίπεδο
USER	Χρήστης
SERV	Service
vaBW	vaBW

551 Lock/unlock
 Επιτρέπει το μπλοκάρισμα των οργάνων ελέγχου και την εισαγωγή ενός κωδικού ασφαλείας.
 βλ. παράγραφο "Lock/unlock (Set up 551)".

552 Τόνος βομβητή
 Επιτρέπει την επιλογή τόνου του βομβητή.

Ελάχιστη	Μέγιστη	Προκαθορισμ
0/μακριά από	10	10

601 Βήμα ρύθμισης
 Επιτρέπει τη ρύθμιση μιας παραμέτρου, με βήμα που μπορεί να επιλεγεί από το χρήστη.

Ελάχιστη	Μέγιστη	Προκαθορισμ
1	Imax	1

602 Εξωτερική παράμετρος CH1, CH2, CH3, CH4
 Επιτρέπει τη διαχείριση της εξωτερικής παραμέτρου 1, 2, 3, 4 (ελάχιστη τιμή, μέγιστη τιμή, προκαθορισμένη τιμή, επιλεγμένη παράμετρος).
 βλ. παράγραφο "διαχείριση εξωτερικών εντολών (Set up 602)".

705 Διακρίβωση αντίστασης κυκλώματος
 Επιτρέπει τη βαθμονόμηση της εγκατάστασης.
 βλ. παράγραφο "Διακρίβωση αντίστασης κυκλώματος (set up 705)".

751 Καταγραφή ρεύματος
 Επιτρέπει την εμφάνιση της πραγματικής τιμής του ρεύματος συγκόλλησης.

752 Καταγραφή τάσης
 Επιτρέπει την εμφάνιση της πραγματικής τιμής της τάσης συγκόλλησης.

768 Μέτρηση θερμικής παροχής HI
 Επιτρέπει την εμφάνιση της τιμής μέτρησης της θερμικής παροχής σε συγκόλληση.

5.1.2 Κατάλογος παραμέτρων στο set up (TIG)

0 Αποθήκευση και έξοδος
 Επιτρέπει την αποθήκευση των αλλαγών και την έξοδο από το set up.

1 Επαναφέρω
 Επιτρέπει την επαναφορά όλων των παραμέτρων στις προκαθορισμένες τιμές (default).

7 Ρεύμα συγκόλλησης
 Επιτρέπει τη ρύθμιση του ρεύματος συγκόλλησης.

Ελάχιστη	Μέγιστη	Προκαθορισμ
3 A	Imax	100 A

399 Ταχύτητα μετατόπισης
 Επιτρέπει τη ρύθμιση της ταχύτητας εκτέλεσης της συγκόλλησης.
 Default cm/min: ταχύτητα αναφοράς για τη χειροκίνητη συγκόλληση.
 Syn: Sinergic αξία.

Ελάχιστη	Μέγιστη	Προκαθορισμ
1 cm/min	200 cm/min	10 cm/min

500

Προγραμματισμός μηχανήματος

Επιτρέπει την επιλογή της επιθυμητής γραφικής διεπαφής.
Επιτρέπει την πρόσβαση στα ανώτερα επίπεδα του set up.
βλ. παράγραφο "Εξατομίκευση οθόνης (Set up 500)"

Τιμή	Διεπαφή Χρήστη
XE	Τρόπος Easy
XA	Τρόπος Advanced
XP	Τρόπος Professional

Τιμή	Επιλεγμένο επίπεδο
USER	Χρήστης
SERV	Service
vaBW	vaBW

551

Lock/unlock

Επιτρέπει το μπλοκάρισμα των οργάνων ελέγχου και την εισαγωγή ενός κωδικού ασφαλείας.
βλ. παράγραφο "Lock/unlock (Set up 551)".

552

Τόνος βομβητή

Επιτρέπει την επιλογή τόνου του βομβητή.

Ελάχιστη	Μέγιστη	Προκαθορισμ
0/μακριά από	10	10

601

Βήμα ρύθμισης

Επιτρέπει τη ρύθμιση μιας παραμέτρου, με βήμα που μπορεί να επιλεχτεί από το χρήστη.

Ελάχιστη	Μέγιστη	Προκαθορισμ
1	Imax	1

602

Εξωτερική παράμετρος CH1, CH2, CH3, CH4

Επιτρέπει τη διαχείριση της εξωτερικής παραμέτρου 1, 2, 3, 4 (ελάχιστη τιμή, μέγιστη τιμή, προκαθορισμένη τιμή, επιλεγμένη παράμετρος).
βλ. παράγραφο "διαχείριση εξωτερικών εντολών (Set up 602)".

705

Διακρίβωση αντίστασης κυκλώματος

Επιτρέπει τη βαθμονόμηση της εγκατάστασης.
βλ. παράγραφο "Διακρίβωση αντίστασης κυκλώματος (set up 705)".

751

Καταγραφή ρεύματος

Επιτρέπει την εμφάνιση της πραγματικής τιμής του ρεύματος συγκόλλησης.

752

Καταγραφή τάσης

Επιτρέπει την εμφάνιση της πραγματικής τιμής της τάσης συγκόλλησης.

755

Καταγραφή παροχής αερί (WFR)

Επιτρέπει την εμφάνιση της πραγματικής τιμής της παροχής αερίου.

757

Ταχύτητα σύρματος

Καταγραφή encoder μοτέρ 1.

760

Καταγραφή ρεύματος (μοτέρ 1)

Επιτρέπει την εμφάνιση της πραγματικής τιμής του ρεύματος (μοτέρ 1).

764

Καταγραφή παροχής ψυκτικού υγρού

Επιτρέπει την εμφάνιση της πραγματικής τιμής παροχής ψυκτικού υγρού.

765 Καταγραφή θερμοκρασία ψυκτικού υγρού
 Επιτρέπει την εμφάνιση της πραγματικής τιμής Θερμοκρασία ψυκτικού υγρού.

768 Μέτρηση θερμικής παροχής HI
 Επιτρέπει την εμφάνιση της τιμής μέτρησης της θερμικής παροχής σε συγκόλληση.

801 Όρια επιφυλακής
 Επιτρέπει τον προγραμματισμό των ορίων προσοχής και των ορίων επιφυλακής.
 Επιτρέπει τον έλεγχο του τρόπου συγκόλλησης, καθορίζοντας κάποια όρια προσοχής και όρια επιφυλακής, στις βασικές μετρήσιμες παραμέτρους.
 Επιτρέπει τον επιμελή έλεγχο των διαφόρων φάσεων συγκόλλησης.
 βλ. παράγραφο "Όρια επιφυλακής (Set up 801)".

5.1.3 Κατάλογος παραμέτρων στο set up (MIG/MAG)

0 Αποθήκευση και έξοδος
 Επιτρέπει την αποθήκευση των αλλαγών και την έξοδο από το set up.

1 Επαναφέρω
 Επιτρέπει την επαναφορά όλων των παραμέτρων στις προκαθορισμένες τιμές (default).

2 Συνεργία
MIG/MAG πρότυπο:
 Επιτρέπει τη επιλογή της διαδικασίας χειροκίνητου MIG (Off) ή συνεργικού MIG (6), καθορίζοντας το προς συγκόλληση υλικό.
MIG Παλμικό:
 Επιτρέπει τη επιλογή της διαδικασίας συνεργικού MIG (6), καθορίζοντας το προς συγκόλληση υλικό.
 Επιτρέπει τη επιλογή της διαδικασίας CC/CV.

3 Ταχύτητα σύρματος
 Επιτρέπει τη ρύθμιση της ταχύτητας προώθησης του σύρματος.

Ελάχιστη	Μέγιστη	Προκαθορισμ
0.5 m/min	22.0 m/min	-

4 Ένταση (ρεύμα)
 Επιτρέπει τη ρύθμιση του ρεύματος συγκόλλησης.

Ελάχιστη	Μέγιστη
3 A	I _{max}

5 Πάχος κομματιού
 Επιτρέπει τον προγραμματισμό του πάχους του προς συγκόλληση κομματιού.
 Επιτρέπει τη ρύθμιση της διάταξης ανάλογα με τα χαρακτηριστικά του προς συγκόλληση κομματιού.

6 Ραφή γωνίας "a"
 Επιτρέπει τη ρύθμισης του βάθους της ραφής σε ένα γωνιακό σημείο σύνδεσης.

7 Τάση - μήκος τόξου
 Επιτρέπει τη ρύθμιση της τάσης του τόξου.
 Επιτρέπει τη ρύθμιση του μήκους του τόξου, κατά τη συγκόλληση.
 Υψηλή τάση = μακρύ τόξο
 Χαμηλή τάση = κοντό τόξο
Χειροκίνητος τρόπος ελέγχου

Ελάχιστη	Μέγιστη	Προκαθορισμ
5.0 V	55.5 V	5.0 V

10 Pre gas

Επιτρέπει τον προγραμματισμό και τη ρύθμιση της ροής αερίου πριν την έναυση του τόξου.
Επιτρέπει την αποστολή αερίου στην τσιμπίδα και την προετοιμασία του περιβάλλοντος για τη συγκόλληση.

Ελάχιστη	Μέγιστη	Προκαθορισμ
0/μακριά από	99.9 s	0.1 s

11 Soft start



Επιτρέπει τη ρύθμιση της ταχύτητας προώθησης του σύρματος, κατά τα στάδια πριν την έναυση.
Επιτρέπει την έναυση με μειωμένη ταχύτητα, έτσι ώστε να είναι ομαλότερη και με λιγότερα πιτσιλίσματα.

Ελάχιστη	Μέγιστη	Προκαθορισμ
10 %	100 %	50 %

12 Επιτάχυνση μοτέρ

Επιτρέπει τη σταδιακή μετάβαση της ταχύτητας σύρματος από την έναυση στη συγκόλληση.

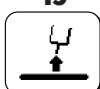
Ελάχιστη	Μέγιστη	Προκαθορισμ
0/μακριά από	1.0 s	0/μακριά από

15 Burn back

Επιτρέπει τη ρύθμιση του χρόνου θέρμανσης του σύρματος, αποτρέποντας την προσκόλληση στο τέλος της συγκόλλησης.

Επιτρέπει τη ρύθμιση του μήκους του σύρματος που προεξέχει από την τσιμπίδα.

Ελάχιστη	Μέγιστη	Προκαθορισμ
-2.00	+2.00	0/syn

16 Post gas

Επιτρέπει τη ρύθμιση της ροής αερίου, στο τέλος της συγκόλλησης.

Ελάχιστη	Μέγιστη	Προκαθορισμ
0/μακριά από	99.9 s	2.0 s

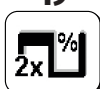
19 Duty cycle (διπλό παλμικό)

Επιτρέπει τον καθορισμό της χρονικής διάρκειας διατήρησης του τελικού ρεύματος.

Ελάχιστη	Μέγιστη	Προκαθορισμ
10 %	90 %	50 %

20 Διπλό παλμικό

Επιτρέπει τη ρύθμιση του εύρους παλμού.

Ελάχιστη	Μέγιστη	Προκαθορισμ
0 %	100 %	±25 %
Ελάχιστη	Μέγιστη	Προκαθορισμ
0.5 m/min	22 m/min	2.5 m/min

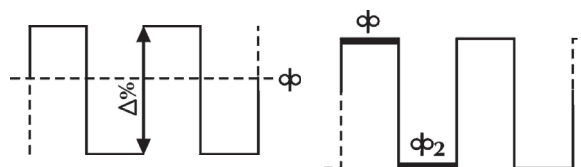
21 Συχνότητα παλμικού (διπλό παλμικό)

Επιτρέπει τη ρύθμιση της χρονικής περιόδου, δηλαδή, του κύκλου επανάληψης του παλμού.

Επιτρέπει τη ρύθμιση της συχνότητας του παλμού.

Ελάχιστη	Μέγιστη	Προκαθορισμ
0.1 Hz	5.0 Hz	2.0 Hz

22 Δευτερεύουσα τάση (διπλό παλμικό)

Επιτρέπει τη ρύθμιση της τάσης του δευτερεύοντος επιπέδου παλμού.

Επιτρέπει τη επίτευξη μεγαλύτερης σταθερότητας τόξου κατά τις διάφορες φάσεις του παλμού.

Ελάχιστη	Μέγιστη	Προκαθορισμ
-5.0	+5.0	0/syn

23 Σταδιακές αυξομειώσεις παλμικού (διπλό παλμικό)

Επιτρέπει τον καθορισμό ενός χρόνου σταδιακής καθόδου κατά το στάδιο των παλμών.

Ελάχιστη	Μέγιστη	Προκαθορισμ
1 %	100 %	50 %

24

Bilevel (4T - crater filler)

Επιτρέπει τη ρύθμιση του ταχύτητα σύρματος, στη λειτουργία συγκόλλησης bilevel.



Αν ο συγκολλητής πατάει και αφήνει γρήγορα το κουμπί περνάει στο “ ϕ_2 ”.

Πατώντας και αφήνοντας γρήγορα το κουμπί περνάει ξανά στο “ ϕ ” κ.ο.κ.

Ελάχιστη	Μέγιστη	Προκαθορισμ
1 %	200 %	0/μακριά από

25

Αρχική αύξηση

Επιτρέπει τη ρύθμιση της τιμής ταχύτητας σύρματος, κατά την πρώτη φάση συγκόλλησης του “crater-filler”.



Επιτρέπει την αύξηση της ενέργειας που παρέχεται στο κομμάτι, κατά τη φάση στην οποία το υλικό (που είναι ακόμη κρύο) απαιτεί περισσότερη θερμότητα, για να λιώσει με ομοιογενή τρόπο.

Ελάχιστη	Μέγιστη	Προκαθορισμ
20 %	200 %	120 %

26

Crater filler

Επιτρέπει τη ρύθμιση της τιμής ταχύτητας σύρματος, κατά τη φάση κλεισίματος της συγκόλλησης.



Επιτρέπει την μείωση της ενέργειας που παρέχεται στο κομμάτι, κατά τη φάση στην οποία το υλικό είναι ήδη πολύ ζεστό, για να αποφευχθεί ο κίνδυνος παραμόρφωσης.

Ελάχιστη	Μέγιστη	Προκαθορισμ
20 %	200 %	80 %

27

Χρονισμός αρχικής αύξησης

Επιτρέπει τον καθορισμό του χρόνου αρχικής αύξησης.



Επιτρέπει τον αυτοματισμό της λειτουργίας “crater filler”.

Ελάχιστη	Μέγιστη	Προκαθορισμ
0.1 s	99.9 s	0/μακριά από

28

Χρονισμός του crater filler

Επιτρέπει τον καθορισμό του χρόνου του “crater filler”.



Επιτρέπει τον αυτοματισμό της λειτουργίας “crater filler”.

Ελάχιστη	Μέγιστη	Προκαθορισμ
0.1 s	99.9 s	0/μακριά από

30

Ποντάρισμα (σημειακή συγκόλληση)

Επιτρέπει την ενεργοποίηση της διαδικασίας “πονταρίσματος” (σημειακής συγκόλλησης) και την επιλογή του χρόνου συγκόλλησης.



Ελάχιστη	Μέγιστη	Προκαθορισμ
0.1 s	99.9 s	0/μακριά από

31

Σημείο παύσης

Επιτρέπει την ενεργοποίηση της διαδικασίας «σημείου παύσης» και την επιλογή του χρόνου παύσης μεταξύ δύο συγκολλήσεων.



Ελάχιστη	Μέγιστη	Προκαθορισμ
0.1 s	99.9 s	0/μακριά από

32

Δευτερεύουσα τάση (Bilevel MIG)

Επιτρέπει τη ρύθμιση της τάσης του δευτερεύοντος επιπέδου παλμού.



Επιτρέπει τη επίτευξη μεγαλύτερης σταθερότητας τόξου κατά τις διάφορες φάσεις του παλμού.

Ελάχιστη	Μέγιστη	Προκαθορισμ
-5.0	+5.0	0/syn

33

Δευτερεύουσα επαγωγή (Bilevel MIG)

Επιτρέπει τη ρύθμιση της επαγωγή του δευτερεύοντος επιπέδου παλμού.



Επιτρέπει την επίτευξη ενός πολύ ή λίγο γρήγορου τόξου, έτσι ώστε να αντισταθμίζει τις κινήσεις του συγκολλητή και της φυσιολογικής αστάθειας της συγκόλλησης.

Χαμηλή επαγωγή = ανπιδραστικό τόξο (περισσότερα πιτσιλίσματα).

Υψηλή επαγωγή = λίγο ανπιδραστικό τόξο (περιορισμένα πιτσιλίσματα).

Ελάχιστη	Μέγιστη	Προκαθορισμ
-30	+30	0/syn

34 Σταδιακή αρχική αύξηση

Επιτρέπει τη ρύθμιση της σταδιακής μετάβασης, από την αρχική αύξηση, στο ρεύμα συγκόλλησης.

Ελάχιστη	Μέγιστη	Προκαθορισμ
0 s	10 s	0/μακριά από

35 Σταδιακή μετάβαση crater filler

Επιτρέπει τη ρύθμιση της σταδιακής μετάβασης, από τη συγκόλληση, στο crater filler.

Ελάχιστη	Μέγιστη	Προκαθορισμ
0 s	10 s	0/μακριά από

202 Επαγωγή

Επιτρέπει την ηλεκτρονική ρύθμιση της επαγωγής σειράς του κυκλώματος συγκόλλησης.

Επιτρέπει την επίτευξη ενός πολύ ή λίγο γρήγορου τόξου, έτσι ώστε να αντισταθμίζει τις κινήσεις του συγκολλητή και της φυσιολογικής αστάθειας της συγκόλλησης.

Χαμηλή επαγωγή = αντιδραστικό τόξο (περισσότερα πιτσιλίσματα).

Υψηλή επαγωγή = λίγο αντιδραστικό τόξο (περιορισμένα πιτσιλίσματα).

Ελάχιστη	Μέγιστη	Προκαθορισμ
-30	+30	0/syn

331 Αντισταθμισμένη μέση τάση

Επιτρέπει τη ρύθμιση της τάσης συγκόλλησης.

399 Ταχύτητα μετατόπισης

Επιτρέπει τη ρύθμιση της ταχύτητας εκτέλεσης της συγκόλλησης.

Default cm/min: ταχύτητα αναφοράς για τη χειροκίνητη συγκόλληση.

Syn: Sinergic αξία.

Ελάχιστη	Μέγιστη	Προκαθορισμ
syn min	syn max	35 cm/min

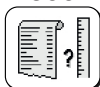
500 Προγραμματισμός μηχανήματος

Επιτρέπει την επιλογή της επιθυμητής γραφικής διεπαφής.

Επιτρέπει την πρόσβαση στα ανώτερα επίπεδα του set up.

βλ. παράγραφο "Εξατομίκευση οθόνης (Set up 500)"

Τιμή	Διεπαφή Χρήστη
XE	Τρόπος Easy
XA	Τρόπος Advanced
XP	Τρόπος Professional

Τιμή	Επιλεγμένο επίπεδο
USER	Χρήστης
SERV	Service
vaBW	vaBW

551 Lock/unlock

Επιτρέπει το μπλοκάρισμα των οργάνων ελέγχου και την εισαγωγή ενός κωδικού ασφαλείας.

βλ. παράγραφο "Lock/unlock (Set up 551)".

552 Τόνος βομβητή

Επιτρέπει την επιλογή τόνου του βομβητή.

Ελάχιστη	Μέγιστη	Προκαθορισμ
0/μακριά από	10	10

601 Βήμα ρύθμισης

Επιτρέπει τη ρύθμιση μιας παραμέτρου, με βήμα που μπορεί να επιλεγεί από το χρήστη.

Η λειτουργία ελέγχεται από το κουμπί πάνω / κάτω του φακού.

Ελάχιστη	Μέγιστη	Προκαθορισμ
1	lmax	1

602 Εξωτερική παράμετρος CH1, CH2, CH3, CH4

Επιτρέπει τη διαχείριση της εξωτερικής παραμέτρου 1, 2, 3, 4 (ελάχιστη τιμή, μέγιστη τιμή, προκαθορισμένη τιμή, επιλεγμένη παράμετρος).

βλ. παράγραφο "διαχείριση εξωτερικών εντολών (Set up 602)".

606 Τσιμπίδα U/D



Επιτρέπει τη διαχείριση της εξωτερικής παραμέτρου (U/D).

Τιμή	Προκαθορισμ	Λειτουργία επανάκλησης
0 / μακριά από	-	μακριά από
1/11	X	Ένταση (ρεύμα)
	-	Άνοιγμα προγραμμάτων

705 Διακρίβωση αντίστασης κυκλώματος



Επιτρέπει τη βαθμονόμηση της εγκατάστασης.

βλ. παράγραφο "Διακρίβωση αντίστασης κυκλώματος (set up 705)".

751 Καταγραφή ρεύματος



Επιτρέπει την εμφάνιση της πραγματικής τιμής του ρεύματος συγκόλλησης.

752 Καταγραφή τάσης



Επιτρέπει την εμφάνιση της πραγματικής τιμής της τάσης συγκόλλησης.

755 Καταγραφή παροχής αερί (WFR)



Επιτρέπει την εμφάνιση της πραγματικής τιμής της παροχής αερίου.

757 Ταχύτητα σύρματος



Καταγραφή encoder μοτέρ 1.

758 Ταχύτητα μετατόπισης ρομπότ



Επιτρέπει την εμφάνιση της ταχύτητας μετατόπισης του βραχίονα ενός ρομπότ ή κάποιας αυτόματης διάταξης.

760 Καταγραφή ρεύματος (μοτέρ 1)



Επιτρέπει την εμφάνιση της πραγματικής τιμής του ρεύματος (μοτέρ 1).

761 Ταχύτητα σύρματος



Καταγραφή encoder μοτέρ 2.

762 Καταγραφή ρεύματος (μοτέρ 2)



Επιτρέπει την εμφάνιση της πραγματικής τιμής του ρεύματος (μοτέρ 2).

763 Ταχύτητα σύρματος



Καταγραφή της πραγματικής προώθησης του σύρματος.

764 Καταγραφή παροχής ψυκτικού υγρού



Επιτρέπει την εμφάνιση της πραγματικής τιμής παροχής ψυκτικού υγρού.

765
Καταγραφή θερμοκρασία ψυκτικού υγρού

Επιτρέπει την εμφάνιση της πραγματικής τιμής Θερμοκρασία ψυκτικού υγρού.

768
Μέτρηση θερμικής παροχής HI

Επιτρέπει την εμφάνιση της τιμής μέτρησης της θερμικής παροχής σε συγκόλληση.

801
Όρια επιφυλακής

Επιτρέπει τον προγραμματισμό των ορίων προσοχής και των ορίων επιφυλακής.

Επιτρέπει τον έλεγχο του τρόπου συγκόλλησης, καθορίζοντας κάποια όρια προσοχής και όρια επιφυλακής, στις βασικές μετρήσιμες παραμέτρους.

Επιτρέπει τον επιμελή έλεγχο των διαφόρων φάσεων συγκόλλησης.



βλ. παράγραφο "Όρια επιφυλακής (Set up 801)".

5.2 Ειδικές διαδικασίες χρήσης των παραμέτρων

5.2.1 Εξατομίκευση οθόνης 7 τμημάτων

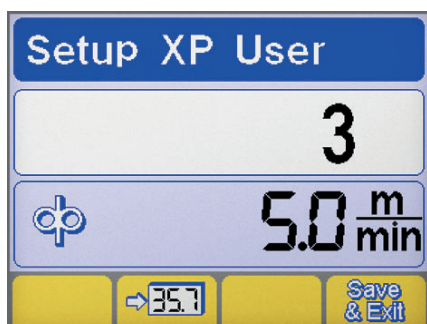
Επιτρέπει τη συνεχή εμφάνιση της τιμής μιας παραμέτρου στην οθόνη 7 τμημάτων.



- ▶ Μπείτε στο set up, πατώντας το πλήκτρο encoder, για 5 τουλάχιστον δευτερόλεπτα.
- ▶ Επιλέξτε την παράμετρο που θέλετε.
- ▶ Αποθηκεύστε στη μνήμη την παράμετρο που έχει επιλεγεί στην οθόνη 7 τμημάτων, πατώντας το πλήκτρο .
- ▶ Αποθηκεύστε στη μνήμη και βγείτε από την τρέχουσα σελίδα, πατώντας το πλήκτρο .

5.2.2 Εξατομίκευση οθόνης (Set up 500)















Επιτρέπει την εξατομίκευση των παραμέτρων της αρχικής σελίδας.

500
Προγραμματισμός μηχανήματος

Επιτρέπει την επιλογή της επιθυμητής γραφικής διεπαφής.

Τιμή	Διεπαφή Χρήστη
XE	Τρόπος Easy
XA	Τρόπος Advanced
XP	Τρόπος Professional

ΛΕΙΤΟΥΡΓΙΑ ΧΕ

MMA	
Παράμετροι συγκόλλησης	
TIG	
Παράμετροι συγκόλλησης	
Λειτουργίες	      
MIG/MAG	
Παράμετροι συγκόλλησης	 
Λειτουργίες	  

ΛΕΙΤΟΥΡΓΙΑ ΧΑ

MMA	
Παράμετροι συγκόλλησης	
Λειτουργίες	
TIG	
Παράμετροι συγκόλλησης	
Λειτουργίες	
MIG/MAG	
Παράμετροι συγκόλλησης	
Λειτουργίες	

ΛΕΙΤΟΥΡΓΙΑ ΧΡ

MMA	
Παράμετροι συγκόλλησης	
Λειτουργίες	
TIG	
Παράμετροι συγκόλλησης	
Λειτουργίες	
MIG/MAG	
Παράμετροι συγκόλλησης	
Λειτουργίες	

5.2.3 Lock/unlock (Set up 551)

Επιτρέπεται το μπλοκάρισμα των οργάνων ελέγχου και την εισαγωγή ενός κωδικού ασφαλείας.

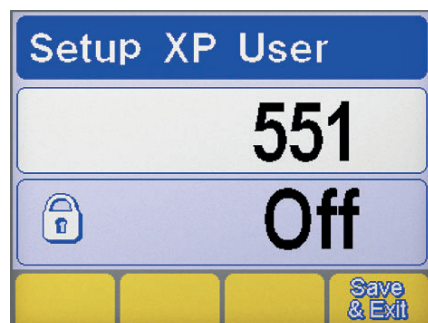

Επιλογή παραμέτρου

- ▶ Μπείτε στο set up, πατώντας το πλήκτρο encoder, για 5 τουλάχιστον δευτερόλεπτα.
- ▶ Επιλέξτε την παράμετρο που θέλετε (551).
- ▶ Ενεργοποιήστε τη ρύθμιση της επιλεγμένης παραμέτρου, πατώντας το πλήκτρο encoder.

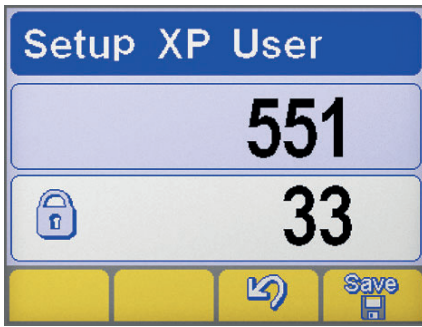

- ▶ Εισάγετε έναν αριθμητικό κωδικό (password), περιστρέφοντας το encoder.
- ▶ Επιβεβαιώστε την ενέργεια πιέζοντας το κουμπί-encoder.
- ▶ Επιβεβαιώστε την ενέργεια, πατώντας το πλήκτρο
- ▶ Για αποθήκευση της τροποποίησης πιέστε το κουμπί:

Λειτουργίες πίνακα



Αν εκτελεστεί μια οποιαδήποτε ενέργεια, όταν ο πίνακας είναι μπλοκαρισμένος, εμφανίζεται μία σελίδα με ειδικές ενδείξεις.

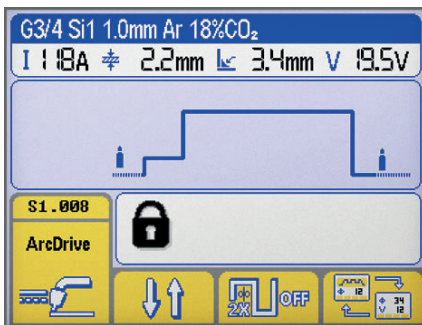

- ▶ Μποείτε προσωρινά (5 λεπτά) στις λειτουργίες του πίνακα ελέγχου: περιστρέψτε το encoder και εισάγετε το σωστό αριθμητικό κωδικό.
- ▶ Επιβεβαιώστε την ενέργεια πιέζοντας το κουμπί-encoder.
- ▶ Απελευθερώστε οριστικά τον πίνακα ελέγχου: μπίετε στο set up (σύμφωνα με τις οδηγίες που υπάρχουν παραπάνω) και επαναφέρετε το "off" στην παράμετρο 551.
- ▶ Επιβεβαιώστε την ενέργεια πιέζοντας το κουμπί-encoder.
- ▶ Για αποθήκευση της τροποποίησης πιέστε το κουμπί:

5.2.4 διαχείριση εξωτερικών εντολών (Set up 602)

Επιτρέπει τη διαχείριση της εξωτερικής παραμέτρου 2 (ελάχιστη τιμή, μέγιστη τιμή, προκαθορισμένη τιμή, επιλεγμένη παράμετρος).

Επιλογή παραμέτρου



- ▶ Μποείτε στο set up, πατώντας το πλήκτρο encoder, για 5 τουλάχιστον δευτερόλεπτα.
- ▶ Επιλέξτε την παράμετρο που θέλετε (602).
- ▶ Μποείτε στη σελίδα "Διαχείριση εξωτερικών εντολών", πατώντας το πλήκτρο encoder.

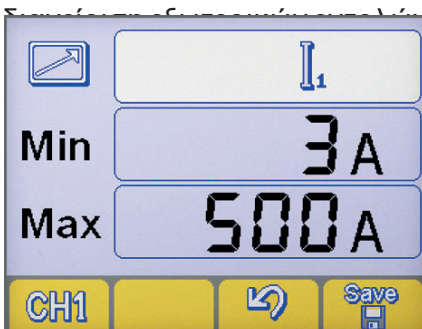

- ▶ Επιλέξτε την επιθυμητή έξοδο ελέγχου RC (CH1, CH2, CH3, CH4), πατώντας το κουμπί:
- ▶ Επιλέξτε την παράμετρο που θέλετε (Min-Max-πάρμετρο), πατώντας το πλήκτρο encoder.
- ▶ Ρυθμίστε την παράμετρο που θέλετε (Min-Max-πάρμετρο), περιστρέφοντας το encoder.
- ▶ Για αποθήκευση της τροποποίησης πιέστε το κουμπί:
- ▶ Επιβεβαιώστε την ενέργεια, πατώντας το πλήκτρο

5.2.5 Διακρίβωση αντίστασης κυκλώματος (set up 705)

Επιτρέπει τη βαθμονόμηση της γεννήτριας ανάλογα με την αντίσταση του χρησιμοποιούμενου κυκλώματος συγκόλλησης.

Επιλογή παραμέτρου

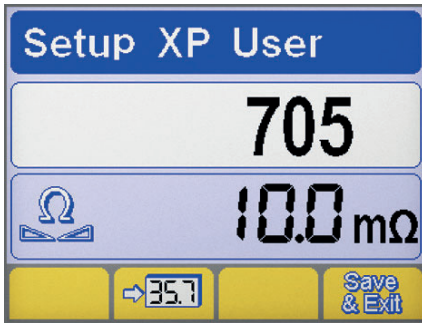

- ▶ Μπείτε στο set up, πατώντας το πλήκτρο encoder, για 5 τουλάχιστον δευτερόλεπτα.
- ▶ Επιλέξτε την παράμετρο που θέλετε (705).
- ▶ Ενεργοποιήστε τη ρύθμιση της επιλεγμένης παραμέτρου, πατώντας το πλήκτρο encoder.
- ▶ Συνδέστε τη γεννήτρια στο κύκλωμα συγκόλλησης (πάγκος ή τεμάχιο).
- ▶ Αφαιρέστε το κάλυμμα για να αποκαλυφθεί το tip ακροφυσίου της σιμπίδας. (MIG/MAG)

κυκλώματος

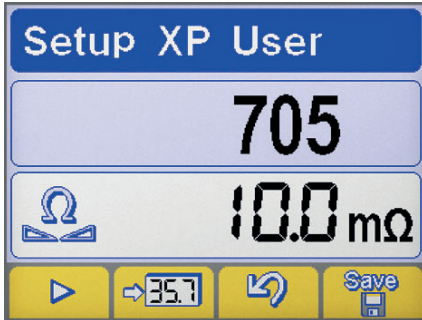

- ▶ Φέρτε σε ηλεκτρική επαφή την αιχμή του οδηγού σύρματος και το προς συγκόλληση κομμάτι. (MIG/MAG)
- ▶ Πατήστε το πλήκτρο για να αρχίσετε τη διαδικασία.
- ▶ Κρατήστε την επαφή τουλάχιστον για ένα δευτερόλεπτο.
- ▶ Η τιμή που εμφανίζεται στην οθόνη ενημερώνεται μετά τη βαθμονόμηση.
- ▶ Επιβεβαιώστε την ενέργεια, πατώντας το πλήκτρο .
- ▶ Επιβεβαιώστε την ενέργεια, πατώντας το πλήκτρο .
- ▶ Για αποθήκευση της τροποποίησης και έξοδο από το set up πιέστε το κουμπί: .

5.2.6 Όρια επιφυλακής (Set up 801)

Επιτρέπει τον προγραμματισμό των ορίων προσοχής και των ορίων επιφυλακής.

Επιτρέπει τον έλεγχο του τρόπου συγκόλλησης, καθορίζοντας κάποια όρια προσοχής και όρια επιφυλακής, στις βασικές μετρήσιμες παραμέτρους.

Επιτρέπει τον επιμελή έλεγχο των διαφόρων φάσεων συγκόλλησης.

Όρια προειδοποίησης		MIN	MAX	Όρια επιφυλακής		MIN	MAX
	Ρεύμα συγκόλλησης				τάση συγκόλλησης		
	Καταγραφή παροχής αερί				Ταχύτητα μετατόπισης ρομπότ		
	Καταγραφή ρεύματος (μοτέρ 1)				Καταγραφή ρεύματος (μοτέρ 2)		
	Καταγραφή παροχής ψυκτικού υγρού				Ταχύτητα σύρματος		
	Καταγραφή θερμοκρασία ψυκτικού υγρού						

Επιλογή παραμέτρου

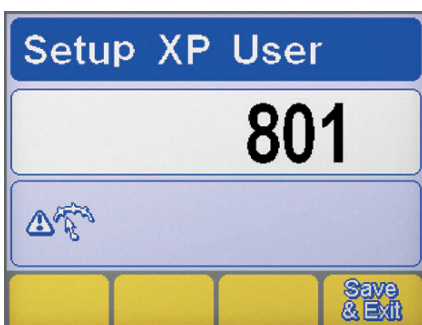

- ▶ Μπείτε στο set up, πατώντας το πλήκτρο encoder, για 5 τουλάχιστον δευτερόλεπτα.
- ▶ Επιλέξτε την παράμετρο που θέλετε (801).
- ▶ Μπείτε στη σελίδα "Όρια επιφυλακής", πατώντας το πλήκτρο encoder.

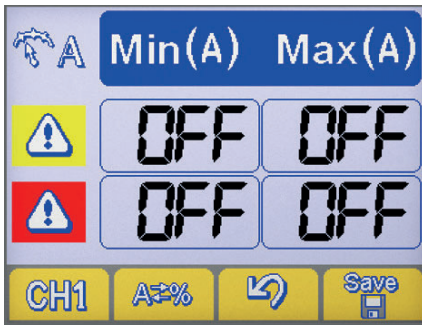
Επιλογή της παραμέτρου

- ▶ Επιλέξτε την παράμετρο που θέλετε, πατώντας το πλήκτρο **CH1**.
- ▶ Επιλέξτε τον τρόπο ρύθμισης των ορίων επιφυλακής, πατώντας το πλήκτρο **A%**.

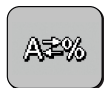

Προγραμματισμός μηχανήματος



Απόλυτη τιμή

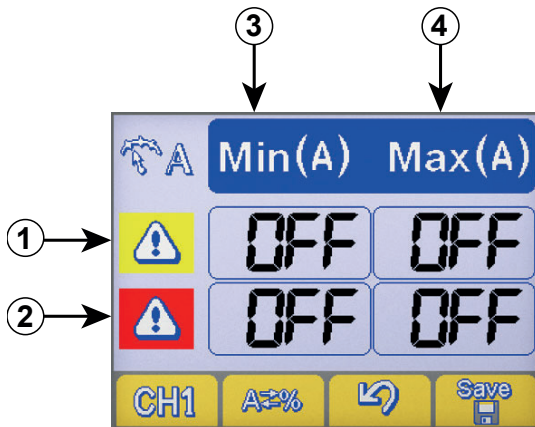

Ποσοστιαία τιμή

Προγραμματισμός ορίων επιφυλακής

- 1 Γραμμή των ορίων προσοχής
- 2 Γραμμή των ορίων συναγερμού
- 3 Στήλη των ελάχιστων σταθμών
- 4 Στήλη των μέγιστων σταθμών

- ▶ Επιλέξτε τη θέση που θέλετε, πατώντας το πλήκτρο encoder (η επιλεγμένη θέση επισημαίνεται με το μαυρισμένο φόντο).
- ▶ Ρυθμίστε τη στάθμη του ορίου που επιλέξατε, περιστρέφοντας το encoder.
- ▶ Για αποθήκευση της τροποποίησης πιέστε το κουμπί: **Save**.



Σε περίπτωση που ξεπεραστεί κάποιο όριο προσοχής, στον πίνακα ελέγχου εμφανίζεται μία προειδοποιητική ένδειξη.



Σε περίπτωση που ξεπεραστεί κάποιο όριο επιφυλακής (συναγερμού), στον πίνακα ελέγχου εμφανίζεται μία προειδοποιητική ένδειξη και μπλοκάρονται αμέσως όλες οι λειτουργίες συγκόλλησης.



Μπορείτε να ενεργοποιήσετε τα φίλτρα έναρξης και τέλους συγκόλλησης, για να αποφύγετε την εμφάνιση ενδείξεων σφάλματος κατά την έναυση και το σβήσιμο του τόξου (βλ. παράγραφο "Set up" - παράμετροι 802-803-804).

6. ΣΥΝΤΗΡΗΣΗ

Η διάταξη πρέπει να συντηρείται τακτική, σύμφωνα με τις οδηγίες του κατασκευαστή. Όλες οι θυρίδες πρόσβασης και συντήρησης, καθώς και τα καπάκια, πρέπει να είναι κλειστά και καλά στερεωμένα, όταν η συσκευή βρίσκεται σε λειτουργία. Απαγορεύεται οποιαδήποτε μετατροπή της διάταξης. Μην επιτρέπετε τη συσσώρευση μεταλλικής σκόνης.



Η ενδεχόμενη συντήρηση πρέπει να εκτελείται μόνο από εξειδικευμένους τεχνικούς. Η επισκευή ή η αντικατάσταση εξαρτημάτων της διάταξης από μη εξειδικευμένο προσωπικό έχει ως συνέπεια την άμεση ακύρωση της εγγύησης του προϊόντος. Η ενδεχόμενη επισκευή ή αντικατάσταση εξαρτημάτων της διάταξης, πρέπει να γίνεται αποκλειστικά από εξειδικευμένους τεχνικούς.



Διακόπτετε την τροφοδοσία ρεύματος, πριν από κάθε επέμβαση!

6.1 Περιοδικοί έλεγχοι

6.1.1 Εγκατάσταση



Καθαρίστε το εσωτερικό με πεπιεσμένο αέρα σε χαμηλή πίεση και μαλακό πινέλο. Ελέγχετε τις ηλεκτρικές συνδέσεις και όλα τα καλώδια σύνδεσης.

6.1.2 Για τη συντήρηση ή την αντικατάσταση των εξαρτημάτων των τσιμπιδών, των τσιμπιδών ηλεκτροδίου και/ή των καλωδίων σώματος γείωσης:



Ελέγξτε τη θερμοκρασία των εξαρτημάτων, για να διαπιστώσετε αν έχουν υπερθερμανθεί.



Χρησιμοποιείτε πάντα γάντια εγκεκριμένου τύπου.



Χρησιμοποιείτε κατάλληλα κλειδιά και εργαλεία.

6.2 Ευθύνη



Σε περίπτωση που δεν γίνεται η συνιστώμενη συντήρηση, παύει η ισχύς όλων των εγγυήσεων και ο κατασκευαστής απαλλάσσεται από οποιαδήποτε ευθύνη. Ο κατασκευαστής δεν φέρει καμία ευθύνη, σε περίπτωση που ο χειριστής δε συμμορφωθεί με τις οδηγίες. Για κάθε αμφιβολία και/ή πρόβλημα, μη διστάσετε να απευθυνθείτε στο πλησιέστερο κέντρο τεχνικής υποστήριξης.

7. ΚΩΔΙΚΟΙ ΣΥΝΑΓΕΡΜΩΝ (ΑΛΑΡΜ)



ΣΥΝΑΓΕΡΜΟΣ

Η επέμβαση ενός συναγερμού ή η υπέρβαση ενός κρίσιμου ορίου επιτήρησης, προκαλεί μια οπτική σήμανση στον πίνακα χειριστηρίων και την άμεση διακοπή των εργασιών συγκόλλησης.



ΠΡΟΣΟΧΗ

Η επέμβαση ενός συναγερμού ή η υπέρβαση ενός κρίσιμου ορίου επιτήρησης, προκαλεί μια οπτική σήμανση στον πίνακα χειριστηρίων και την άμεση διακοπή των εργασιών συγκόλλησης.

Στη συνέχεια παρουσιάζονται όλοι οι συναγερμοί και όλα τα όρια επιτήρησης σχετικά με την εγκατάσταση.

E01	Υπερθέρμανση		E02	Υπερθέρμανση	
E03	Υπερθέρμανση		E05	Υπερένταση	
E06	Υπερένταση μονάδας ισχύος (Boost)		E07	Ανωμαλία συστήματος τροφοδοσίας του κινητήρα έλξης σύρματος	
E08	Moteur bloqué		E10	Υπερένταση μονάδας ισχύος (Inverter)	
E11	Σφάλμα διαμόρφωσης εγκατάστασης		E12	Σφάλμα επικοινωνίας (WF - DSP)	
E13	Σφάλμα επικοινωνίας		E14	Μη έγκυρο πρόγραμμα	
E15	Μη έγκυρο πρόγραμμα		E16	Σφάλμα επικοινωνίας (RI) (Αυτοματισμοί και ρομπότ)	

E17	Σφάλμα επικοινωνίας (μP-DSP)		E18	Μη έγκυρο πρόγραμμα	
E19	Σφάλμα διαμόρφωσης εγκατάστασης		E20	Βλάβη μνήμης	
E21	Απώλεια δεδομένων		E22	Σφάλμα επικοινωνίας (DSP)	
E29	Ασύμβατα μεγέθη		E30	Σφάλμα επικοινωνίας (H.F.)	
E32	Απώλεια δεδομένων		E38	Υπόταση	
E39	Ανωμαλία τροφοδοσίας εγκατάστασης		E40	Ανωμαλία τροφοδοσίας εγκατάστασης	
E43	Απουσία ψυκτικού υγρού		E48	Απουσία σύρματος (Αυτοματισμοί και ρομπότ)	
E49	Διακόπτης έκτακτης ανάγκης (Αυτοματισμοί και ρομπότ)		E50	Κολλημένο σύρμα (Αυτοματισμοί και ρομπότ)	
E51	Μη υποστηριζόμενες ρυθμίσεις (Αυτοματισμοί και ρομπότ)		E52	Προστασία από προσκρούσεις (Αυτοματισμοί και ρομπότ)	
E53	Σφάλμα εξωτερικού ροοστάτη (Αυτοματισμοί και ρομπότ)		E54	Υπέρβαση ορίου έντασης (Κατώτερο όριο)	
E55	Υπέρβαση ορίου έντασης (Ανώτερο όριο)		E56	Υπέρβαση ορίου τάσης (Κατώτερο όριο)	
E57	Υπέρβαση ορίου τάσης (Ανώτερο όριο)		E60	Υπέρβαση ορίου ταχύτητας (Κατώτερο όριο)	
E61	Υπέρβαση ορίου ταχύτητας (Ανώτερο όριο)		E62	Υπέρβαση ορίου έντασης (Κατώτερο όριο)	
E63	Υπέρβαση ορίου έντασης (Ανώτερο όριο)		E64	Υπέρβαση ορίου τάσης (Κατώτερο όριο)	
E65	Υπέρβαση ορίου τάσης (Ανώτερο όριο)		E68	Υπέρβαση ορίου ταχύτητας (Κατώτερο όριο)	
E69	Υπέρβαση ορίου ταχύτητας (Ανώτερο όριο)		E70	Μη συμβατά επιλεγμένα όρια επιφυλακής	
E71	Υπερθέρμανση ψυκτικού υγρού		E72	Υπερένταση κινητήρα push-pull	

 Υπέρβαση ορίου ταχύτητας σύρματος (speed meter) 	 Υπέρβαση ορίου ρεύματος κινητήρα 1 
 Υπέρβαση ορίου ρεύματος κινητήρα 2 	 Υπέρβαση ορίου ροής ψυκτικού υγρού 
 Υπέρβαση ορίου θερμοκρασίας ψυκτικού υγρού 	 Συντήρηση σε εξέλιξη (Αυτοματισμοί και ρομπότ) 

8. ΔΙΑΓΝΩΣΗ ΠΡΟΒΛΗΜΑΤΩΝ ΚΑΙ ΛΥΣΕΙΣ

Αποτυχία ανάμματος της συσκευής (πράσινη λυχνία σβηστή)

Αιτία	Λύση
» Απουσία τάσης στην πρίζα τροφοδοσίας.	» Ελέγξτε και ενδεχομένως επισκευάστε την ηλεκτρική εγκατάσταση. » Απευθυνθείτε σε εξειδικευμένο προσωπικό.
» Ελαττωματικό φως ή ηλεκτρικό καλώδιο.	» Αντικαταστήστε το ελαττωματικό εξάρτημα. » Απευθυνθείτε στο πλησιέστερο κέντρο τεχνικής υποστήριξης, για την επισκευή της διάταξης.
» Καμένη ασφάλεια γραμμής.	» Αντικαταστήστε το ελαττωματικό εξάρτημα.
» Διακόπτης τροφοδοσίας ελαττωματικός.	» Αντικαταστήστε το ελαττωματικό εξάρτημα. » Απευθυνθείτε στο πλησιέστερο κέντρο τεχνικής υποστήριξης, για την επισκευή της διάταξης.
» Λανθασμένη ή ελαττωματική σύνδεση μεταξύ τροφοδότη και γεννήτριας.	» Εξακριβώστε αν έγιναν σωστά οι συνδέσεις των διαφόρων μερών της διάταξης.
» Ηλεκτρονικά μέρη ελαττωματικά.	» Απευθυνθείτε στο πλησιέστερο κέντρο τεχνικής υποστήριξης, για την επισκευή της διάταξης.

Απουσία ισχύος στην έξοδο (η μηχανή δεν εκτελεί συγκόλληση)

Αιτία	Λύση
» Ελαττωματικό μπουτόν τσιμπίδας.	» Αντικαταστήστε το ελαττωματικό εξάρτημα. » Απευθυνθείτε στο πλησιέστερο κέντρο τεχνικής υποστήριξης, για την επισκευή της διάταξης.
» Υπερθέρμανση μηχανής (συναγεμρός θερμικής ασφάλειας - κίτρινη λυχνία αναμμένη).	» Περιμένετε να κρυώσει η μηχανή, χωρίς να την σβήσετε.
» Πλευρικό τοίχωμα ανοιχτό ή ελαττωματικός διακόπτης πόρτας.	» Για την ασφάλεια του χειριστή το πλευρικό τοίχωμα πρέπει να είναι κλειστό κατά τη διάρκεια της συγκόλλησης. » Αντικαταστήστε το ελαττωματικό εξάρτημα. » Απευθυνθείτε στο πλησιέστερο κέντρο τεχνικής υποστήριξης, για την επισκευή της διάταξης.
» Λανθασμένη σύνδεση σώματος γείωσης.	» Κάντε σωστά τη σύνδεση του σώματος γείωσης. » Συμβουλευθείτε την παράγραφο "Θέση σε λειτουργία".
» Τάση δικτύου εκτός εύρους προκαθορισμένων τιμών (κίτρινη λυχνία αναμμένη).	» Επαναφορά της τάσης δικτύου εντός των ορίων τροφοδοσίας της γεννήτριας. » Συνδέστε σωστά τη διάταξη. » Συμβουλευθείτε την παράγραφο "Σύνδεση".
» Ηλεκτρονικά μέρη ελαττωματικά.	» Απευθυνθείτε στο πλησιέστερο κέντρο τεχνικής υποστήριξης, για την επισκευή της διάταξης.

Λανθασμένη παροχή ισχύος

Αιτία	Λύση
» Λανθασμένη επιλογή διαδικασίας συγκόλλησης ή ελαττωματικός διακόπτης επιλογής.	» Επιλέξτε τη σωστή διαδικασία συγκόλλησης. » Αντικαταστήστε το ελαττωματικό εξάρτημα. » Απευθυνθείτε στο πλησιέστερο κέντρο τεχνικής υποστήριξης, για την επισκευή της διάταξης.
» Λανθασμένες ρυθμίσεις παραμέτρων και λειτουργιών της διάταξης.	» Reset εγκατάστασης και επαναπρογραμματισμός των παραμέτρων συγκόλλησης.

» Ελαττωματικό ποτενσιόμετρο/encoder για τη ρύθμιση του ρεύματος συγκόλλησης.

» Τάση δικτύου εκτός εύρους προκαθορισμένων τιμών.

» Απουσία μιας φάσης.

» Ηλεκτρονικά μέρη ελαττωματικά.

» Αντικαταστήστε το ελαττωματικό εξάρτημα.

» Απευθυνθείτε στο πλησιέστερο κέντρο τεχνικής υποστήριξης, για την επισκευή της διάταξης.

» Συνδέστε σωστά τη διάταξη.

» Συμβουλευθείτε την παράγραφο “Σύνδεση”.

» Συνδέστε σωστά τη διάταξη.

» Συμβουλευθείτε την παράγραφο “Σύνδεση”.

» Απευθυνθείτε στο πλησιέστερο κέντρο τεχνικής υποστήριξης, για την επισκευή της διάταξης.

Εμπλοκή πρόωσης σύρματος

Αιτία

» Ελαττωματικό μπουτόν τσιμπίδας.

» Ακατάλληλα ή ελαττωματικά ράουλα.

» Ελαττωματικός ηλεκτρομειωτήρας.

» Φθορά περιβλήματος τσιμπίδας.

» Διακοπή τροφοδότη σύρματος.

» Ακανόνιστο τύλιγμα στο καρούλι.

» Ακροφύσιο (μπεκ) τσιμπίδας λειωμένο (σύρμα κολλημένο).

Λύση

» Αντικαταστήστε το ελαττωματικό εξάρτημα.

» Απευθυνθείτε στο πλησιέστερο κέντρο τεχνικής υποστήριξης, για την επισκευή της διάταξης.

» Αντικαταστήστε τα ράουλα.

» Αντικαταστήστε το ελαττωματικό εξάρτημα.

» Απευθυνθείτε στο πλησιέστερο κέντρο τεχνικής υποστήριξης, για την επισκευή της διάταξης.

» Αντικαταστήστε το ελαττωματικό εξάρτημα.

» Απευθυνθείτε στο πλησιέστερο κέντρο τεχνικής υποστήριξης, για την επισκευή της διάταξης.

» Ελέγξτε τη σύνδεση με τη γεννήτρια.

» Συμβουλευθείτε την παράγραφο “Σύνδεση”.

» Απευθυνθείτε στο πλησιέστερο κέντρο τεχνικής υποστήριξης, για την επισκευή της διάταξης.

» Αποκαταστήστε τις ομαλές συνθήκες ξετυλίγματος του καρουλιού ή αντικαταστήστε το.

» Αντικαταστήστε το ελαττωματικό εξάρτημα.

Ακανόνιστη πρόωση σύρματος

Αιτία

» Ελαττωματικό μπουτόν τσιμπίδας.

» Ακατάλληλα ή ελαττωματικά ράουλα.

» Ελαττωματικός ηλεκτρομειωτήρας.

» Φθορά περιβλήματος τσιμπίδας.

» Κακή ρύθμιση φρένου βάσης καρουλιού ή διατάξεων εμπλοκής ράουλων.

Λύση

» Αντικαταστήστε το ελαττωματικό εξάρτημα.

» Απευθυνθείτε στο πλησιέστερο κέντρο τεχνικής υποστήριξης, για την επισκευή της διάταξης.

» Αντικαταστήστε τα ράουλα.

» Αντικαταστήστε το ελαττωματικό εξάρτημα.

» Απευθυνθείτε στο πλησιέστερο κέντρο τεχνικής υποστήριξης, για την επισκευή της διάταξης.

» Αντικαταστήστε το ελαττωματικό εξάρτημα.

» Απευθυνθείτε στο πλησιέστερο κέντρο τεχνικής υποστήριξης, για την επισκευή της διάταξης.

» Ξεσφίξτε το φρένο.

» Αυξήστε την πίεση στα ράουλα.

Αστάθεια τόξου

Αιτία

» Ανεπαρκής προστασία του αερίου.

» Υγρασία στο αέριο συγκόλλησης.

» Λανθασμένες παράμετροι συγκόλλησης.

Λύση

» Ρυθμίστε σωστά τη ροή αερίου.

» Βεβαιωθείτε ότι το στόμιο και το μπεκ αερίου της τσιμπίδας βρίσκονται σε καλή κατάσταση.

» Χρησιμοποιείτε πάντοτε προϊόντα και υλικά καλής ποιότητας.

» Διατηρείτε σε άριστη κατάσταση τη διάταξη τροφοδοσίας αερίου.

» Ελέγξτε προσεκτικά τη διάταξη συγκόλλησης.

» Απευθυνθείτε στο πλησιέστερο κέντρο τεχνικής υποστήριξης, για την επισκευή της διάταξης.

Υπερβολικά πισιλίσματα

Αιτία	Λύση
» Λανθασμένο μήκος τόξου.	» Μειώστε την απόσταση μεταξύ ηλεκτροδίου και τεμαχίου.
» Λανθασμένες παράμετροι συγκόλλησης.	» Μειώστε την τάση συγκόλλησης.
» Ανεπαρκής προστασία του αερίου.	» Ελαττώστε το ρεύμα συγκόλλησης.
» Λανθασμένη δυναμική τόξου.	» Ρυθμίστε σωστά τη ροή αερίου.
» Λανθασμένος τρόπος εκτέλεσης συγκόλλησης.	» Βεβαιωθείτε ότι το στόμιο και το μπεκ αερίου της τσιμπίδας βρίσκονται σε καλή κατάσταση.
	» Αυξήστε την επαγωγική τιμή του κυκλώματος.
	» Χρησιμοποιείτε μεγαλύτερη επαγωγική παροχή.
	» Ελαττώστε την κλίση της τσιμπίδας.

Ανεπαρκής διείσδυση

Αιτία	Λύση
» Λανθασμένος τρόπος εκτέλεσης συγκόλλησης.	» Ελαττώστε την ταχύτητα προώθησης της συγκόλλησης.
» Λανθασμένες παράμετροι συγκόλλησης.	» Αυξήστε το ρεύμα συγκόλλησης.
» Ακατάλληλο ηλεκτρόδιο.	» Χρησιμοποιήστε ηλεκτρόδιο με μικρότερη διάμετρο.
» Λανθασμένη προετοιμασία άκρων.	» Αυξήστε το άνοιγμα του διάκενου.
» Λανθασμένη σύνδεση σώματος γείωσης.	» Κάντε σωστά τη σύνδεση του σώματος γείωσης.
» Μεγάλες διαστάσεις των προς συγκόλληση κομματιών.	» Συμβουλευθείτε την παράγραφο “Θέση σε λειτουργία”.
	» Αυξήστε το ρεύμα συγκόλλησης.

Εγκλωβισμός σκουριάς

Αιτία	Λύση
» Ατελής απομάκρυνση της σκουριάς.	» Καθαρίστε καλά τα κομμάτια, πριν τη συγκόλληση.
» Πολύ μεγάλη διάμετρος ηλεκτροδίου.	» Χρησιμοποιήστε ηλεκτρόδιο με μικρότερη διάμετρο.
» Λανθασμένη προετοιμασία άκρων.	» Αυξήστε το άνοιγμα του διάκενου.
» Λανθασμένος τρόπος εκτέλεσης συγκόλλησης.	» Μειώστε την απόσταση μεταξύ ηλεκτροδίου και τεμαχίου.
	» Κινηθείτε με ομαλό ρυθμό, σε όλες τις φάσεις συγκόλλησης.

Εγκλωβισμός βολφραμίου

Αιτία	Λύση
» Λανθασμένες παράμετροι συγκόλλησης.	» Ελαττώστε το ρεύμα συγκόλλησης.
» Ακατάλληλο ηλεκτρόδιο.	» Χρησιμοποιήστε ένα ηλεκτρόδιο με μεγαλύτερη διάμετρο.
» Λανθασμένος τρόπος εκτέλεσης συγκόλλησης.	» Χρησιμοποιείτε πάντοτε προϊόντα και υλικά καλής ποιότητας.
	» Τροχήστε σωστά το ηλεκτρόδιο.
	» Αποφύγετε τις επαφές μεταξύ ηλεκτροδίου και λουτρού συγκόλλησης.

Φυσήματα

Αιτία	Λύση
» Ανεπαρκής προστασία του αερίου.	» Ρυθμίστε σωστά τη ροή αερίου.
	» Βεβαιωθείτε ότι το στόμιο και το μπεκ αερίου της τσιμπίδας βρίσκονται σε καλή κατάσταση.

Κολλήματα

Αιτία	Λύση
» Λανθασμένο μήκος τόξου.	» Αυξήστε την απόσταση μεταξύ ηλεκτροδίου και κομματιού.
» Λανθασμένες παράμετροι συγκόλλησης.	» Αυξήστε την τάση συγκόλλησης.
» Λανθασμένος τρόπος εκτέλεσης συγκόλλησης.	» Αυξήστε το ρεύμα συγκόλλησης.
	» Αυξήστε την τάση συγκόλλησης.
	» Αυξήστε περισσότερο την γωνία κλίσης της τσιμπίδας.

- » Μεγάλες διαστάσεις των προς συγκόλληση κομματιών.
- » Λανθασμένη δυναμική τόξου.

- » Αυξήστε το ρεύμα συγκόλλησης.

- » Αυξήστε την επαγωγική τιμή του κυκλώματος.
- » Χρησιμοποιείτε μεγαλύτερη επαγωγική παροχή.

Ρηγματώσεις στις άκρες
Αιτία

- » Λανθασμένες παράμετροι συγκόλλησης.
- » Λανθασμένο μήκος τόξου.
- » Λανθασμένος τρόπος εκτέλεσης συγκόλλησης.
- » Ανεπαρκής προστασία του αερίου.

Λύση

- » Ελαττώστε το ρεύμα συγκόλλησης.
- » Χρησιμοποιήστε ηλεκτρόδιο με μικρότερη διάμετρο.
- » Μειώστε την απόσταση μεταξύ ηλεκτροδίου και τεμαχίου.
- » Μειώστε την τάση συγκόλλησης.
- » Μειώστε την ταχύτητα πλευρικής ταλάντωσης κατά το γέμισμα.
- » Ελαττώστε την ταχύτητα προώθησης της συγκόλλησης.
- » Χρησιμοποιείτε αέρια κατάλληλα για τα προς συγκόλληση υλικά.

Οξειδώσεις
Αιτία

- » Ανεπαρκής προστασία του αερίου.

Λύση

- » Ρυθμίστε σωστά τη ροή αερίου.
- » Βεβαιωθείτε ότι το στόμιο και το μπεκ αερίου της τσιμπιδας βρίσκονται σε καλή κατάσταση.

Πόροι
Αιτία

- » Γράσο, βερνίκι, σκουριά ή βρωμιά στα προς συγκόλληση κομμάτια.
- » Γράσο, βερνίκι, σκουριά ή βρωμιά στο υλικό συγκόλλησης (κόλληση).
- » Υγρασία στο υλικό συγκόλλησης (κόλληση).
- » Λανθασμένο μήκος τόξου.
- » Υγρασία στο αέριο συγκόλλησης.
- » Ανεπαρκής προστασία του αερίου.
- » Πολύ γρήγορη στερεοποίηση του λουτρού συγκόλλησης.

Λύση

- » Καθαρίστε καλά τα κομμάτια, πριν τη συγκόλληση.
- » Χρησιμοποιείτε πάντοτε προϊόντα και υλικά καλής ποιότητας.
- » Διατηρείτε πάντοτε σε τέλεια κατάσταση το υλικό συγκόλλησης (κόλληση).
- » Χρησιμοποιείτε πάντοτε προϊόντα και υλικά καλής ποιότητας.
- » Διατηρείτε πάντοτε σε τέλεια κατάσταση το υλικό συγκόλλησης (κόλληση).
- » Μειώστε την απόσταση μεταξύ ηλεκτροδίου και τεμαχίου.
- » Μειώστε την τάση συγκόλλησης.
- » Χρησιμοποιείτε πάντοτε προϊόντα και υλικά καλής ποιότητας.
- » Διατηρείτε σε άριστη κατάσταση τη διάταξη τροφοδοσίας αερίου.
- » Ρυθμίστε σωστά τη ροή αερίου.
- » Βεβαιωθείτε ότι το στόμιο και το μπεκ αερίου της τσιμπιδας βρίσκονται σε καλή κατάσταση.
- » Ελαττώστε την ταχύτητα προώθησης της συγκόλλησης.
- » Προθερμαίνετε τα προς συγκόλληση κομμάτια.
- » Αυξήστε το ρεύμα συγκόλλησης.

Ρωγμές εν θερμώ
Αιτία

- » Λανθασμένες παράμετροι συγκόλλησης.
- » Γράσο, βερνίκι, σκουριά ή βρωμιά στα προς συγκόλληση κομμάτια.
- » Γράσο, βερνίκι, σκουριά ή βρωμιά στο υλικό συγκόλλησης (κόλληση).
- » Λανθασμένος τρόπος εκτέλεσης συγκόλλησης.
- » Τα προς συγκόλληση κομμάτια έχουν διαφορετικά χαρακτηριστικά.

Λύση

- » Ελαττώστε το ρεύμα συγκόλλησης.
- » Χρησιμοποιήστε ηλεκτρόδιο με μικρότερη διάμετρο.
- » Καθαρίστε καλά τα κομμάτια, πριν τη συγκόλληση.
- » Χρησιμοποιείτε πάντοτε προϊόντα και υλικά καλής ποιότητας.
- » Διατηρείτε πάντοτε σε τέλεια κατάσταση το υλικό συγκόλλησης (κόλληση).
- » Εφαρμόστε την κατάλληλη διαδικασία, για τον τύπο του προς συγκόλληση συνδέσμου.
- » Επαλείψτε πάστα ή λίπος, πριν τη συγκόλληση.

Ρωγμές εν ψυχρώ

Αιτία	Λύση
» Υγρασία στο υλικό συγκόλλησης (κόλληση).	» Χρησιμοποιείτε πάντοτε προϊόντα και υλικά καλής ποιότητας.
	» Διατηρείτε πάντοτε σε τέλεια κατάσταση το υλικό συγκόλλησης (κόλληση).
» Ιδιαίτερη γεωμετρική μορφή του προς συγκόλληση συνδέσμου.	» Προθερμαίνετε τα προς συγκόλληση κομμάτια.
	» Θέρμανση μετά τη συγκόλληση/κοπή.
	» Εφαρμόστε την κατάλληλη διαδικασία, για τον τύπο του προς συγκόλληση συνδέσμου.

9. ΣΥΝΤΟΜΗ ΑΝΑΦΟΡΑ ΣΤΗ ΘΕΩΡΙΑ ΤΗΣ ΣΥΓΚΟΛΛΗΣΗΣ

9.1 Συγκόλληση με επενδυμένο ηλεκτρόδιο (MMA)

Προετοιμασία των άκρων

Για την επίτευξη σωστής συγκόλλησης, είναι πάντοτε σκόπιμο τα άκρα να είναι καθαρά, χωρίς οξειδία, σκουριά ή άλλους ρυπογόνους παράγοντες.

Επιλογή του ηλεκτροδίου

Η διάμετρος του ηλεκτροδίου που θα χρησιμοποιηθεί εξαρτάται από το πάχος του υλικού, τη θέση, τον τύπο της σύνδεσης και τον τύπο του διάκενου. Τα ηλεκτρόδια μεγάλης διαμέτρου απαιτούν υψηλά ρεύματα και, κατά συνέπεια, υψηλή θερμική παροχή στη συγκόλληση.

Τύπος επένδυσης	Χαρακτηριστικά	Χρήση
Ρουτιλίου	Ευκολία χρήσης	Όλες οι θέσεις
Όξινη	Υψηλή ταχύτητα τήξης	Επίπεδο
Βασικό	Μηχανικά χαρακτηριστικά	Όλες οι θέσεις

Επιλογή ρεύματος συγκόλλησης

Το εύρος των τιμών ρεύματος συγκόλλησης του κάθε τύπου χρησιμοποιούμενου ηλεκτροδίου επισημαίνεται από τον κατασκευαστή πάνω στη συσκευασία των ηλεκτροδίων.

Έναυση και διατήρηση τόξου

Το ηλεκτρικό τόξο παράγεται τρίβοντας το άκρο του ηλεκτροδίου πάνω στο προς συγκόλληση κομμάτι, στο οποίο είναι συνδεδεμένο το σώμα γείωσης. Μετά τη έναυση του τόξου, η τσιμπίδα απομακρύνεται, στην κανονική απόσταση συγκόλλησης.

Για να ευνοηθεί η έναυση του τόξου, πρέπει, στην αρχή, να δοθεί μία μεγαλύτερη ποσότητα ρεύματος, σε σχέση με το κανονικό ρεύμα συγκόλλησης (Hot Start). Αφού σταθεροποιηθεί το ηλεκτρικό τόξο, αρχίζει η τήξη του κεντρικού τμήματος του ηλεκτροδίου, που εναποτίθεται υπό μορφή σταγόνων πάνω στο συγκολλούμενο κομμάτι. Η εξωτερική επένδυση του ηλεκτροδίου, ενώ καταναλώνεται, παρέχει το αέριο που προστατεύει τη συγκόλληση και, συνεπώς, την καλή ποιότητά της. Για να αποφευχθεί το σβήσιμο του τόξου από τις σταγόνες του λειωμένου υλικού, που βραχυκυκλώνουν το ηλεκτρόδιο με το λουτρό συγκόλλησης, εξαιτίας της κατά λάθος προσέγγισης αυτών των δύο, είναι πολύ χρήσιμη μία στιγμιαία αύξηση του ρεύματος συγκόλλησης, έως ότου ξεπεραστεί το βραχυκύκλωμα (Arc Force). Σε περίπτωση που το ηλεκτρόδιο παραμείνει κολλημένο στο συγκολλούμενο κομμάτι, πρέπει να μειωθεί στο ελάχιστο το ρεύμα βραχυκυκλώματος (anti-sticking).

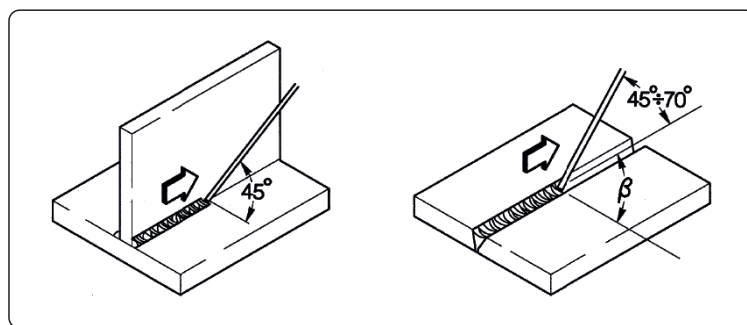

Εκτέλεση της συγκόλλησης

Η γωνία κλίσης του ηλεκτροδίου ποικίλει ανάλογα με τον αριθμό των περασμάτων. Η κίνηση του ηλεκτροδίου είναι συνήθως παλινδρομική και με στάσεις στα πλευρικά άκρα της ραφής, έτσι ώστε να αποφεύγεται η υπερβολική συσσώρευση υλικού συγκόλλησης στο κέντρο.

Αφαίρεση της σκουριάς

Στη συγκόλληση με επενδυμένα ηλεκτρόδια, μετά από κάθε πέρασμα, πρέπει να αφαιρείται η επικαλυπτική σκουριά. Η αφαίρεση γίνεται με μικρή σφυρί (ματσάκονι) ή με συρματόβουρτσα, όταν η σκουριά είναι ψαθυρή.

9.2 Συγκόλληση TIG (συνεχές τόξο)

Περιγραφή

Η συγκόλληση TIG (Tungsten Inert Gas) βασίζεται στην αρχή της δημιουργίας ενός ηλεκτρικού τόξου μεταξύ ενός άηκτου ηλεκτροδίου (καθαρό βολφράμιο ή κράμα, με θερμοκρασία τήξης περίπου 3370°C) και του μεταλλικού κομματιού. Ένα αδρανές αέριο (Αργό) προστατεύει το λουτρό συγκόλλησης. Για να αποφευχθούν οι επικίνδυνοι εγκλωβισμοί βολφραμίου στη ραφή, το ηλεκτρόδιο δεν πρέπει να έρχεται ποτέ σε επαφή με το προς συγκόλληση κομμάτι. Για το λόγο αυτό, μέσω μιας γεννήτριας υψηλής συχνότητας (H.F.), δημιουργείται μια εκκένωση, που επιτρέπει την έναυση του ηλεκτρικού τόξου από απόσταση. Υπάρχει και άλλος τύπος έναυσης, με περιορισμένους εγκλωβισμούς βολφραμίου: η έναυση lift, που δεν προβλέπει υψηλή συχνότητα, αλλά μία αρχική κατάσταση βραχυκυκλώματος με χαμηλό ρεύμα, μεταξύ ηλεκτροδίου και τεμαχίου. Τη στιγμή που απομακρύνεται το ηλεκτρόδιο, δημιουργείται το τόξο και το ρεύμα αυξάνει ως την επιλεγμένη τιμή. Για να βελτιωθεί η ποιότητα του τελικού μέρους της ραφής συγκόλλησης, είναι χρήσιμο να μπορεί να ελεγχθεί με ακρίβεια η σταδιακή ελάττωση του ρεύματος συγκόλλησης και πρέπει απαραίτητα το αέριο να ρέει μέσα στο λουτρό συγκόλλησης, για μερικά δευτερόλεπτα ακόμη, μετά τη λήξη του τόξου. Σε πολλές εργασίες, είναι χρήσιμη η ύπαρξη 2 διαφορετικών προκαθορισμένων ρευμάτων συγκόλλησης και η δυνατότητα εύκολης μετάβασης από το ένα στο άλλο (BILEVEL).

Πολικότητα συγκόλλησης

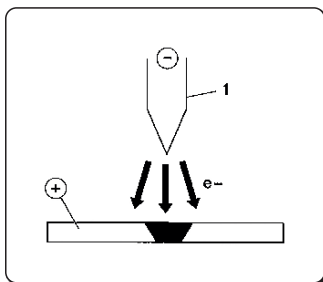

D.C.S.P. (Direct Current Straight Polarity)

Είναι η συνηθέστερη πολικότητα (άμεση ή κανονική πολικότητα) και επιτρέπει περιορισμένη φθορά του ηλεκτροδίου (1), εφόσον το 70% της θερμότητας συγκεντρώνεται στην άνοδο (συγκολλούμενο κομμάτι).

Επιτυγχάνονται στενά και βαθιά λουτρά, με υψηλές ταχύτητες πρόωσης και, κατά συνέπεια, χαμηλή θερμική παροχή.

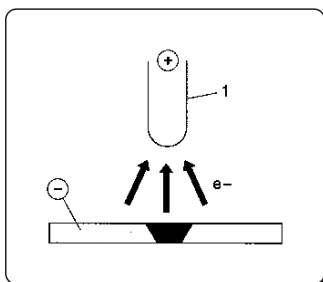

D.C.R.P. (Direct Current Reverse Polarity)

Η πολικότητα είναι ανάστροφη και επιτρέπει τη συγκόλληση κραμάτων που καλύπτονται από στρώμα αδρανούς οξειδίου με θερμοκρασία τήξης μεγαλύτερη από αυτή του μετάλλου.

Δεν μπορούν να χρησιμοποιηθούν υψηλά ρεύματα, γιατί προκαλούν υπερβολική φθορά του ηλεκτροδίου.

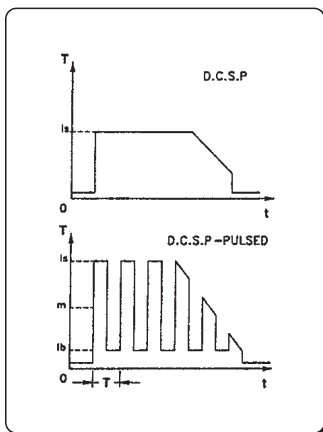

D.C.S.P.-Pulsed (Direct Current Straight Polarity Pulsed)

Η χρήση ενός συνεχούς παλμικού ρεύματος επιτρέπει τον καλύτερο έλεγχο του λουτρού συγκόλλησης σε ειδικές συνθήκες εργασίας.

Το λουτρό συγκόλλησης σχηματίζεται από τους παλμούς αιχμής (I_p), ενώ το βασικό ρεύμα (I_b) διατηρεί το τόξο αναμμένο. Αυτό διευκολύνει τη συγκόλληση κομματιών μικρού πάχους, με μικρότερη παραμόρφωση, καλύτερο συντελεστή μορφής και, συνεπώς, μικρότερο κίνδυνο ρηγματώσεων εν θερμώ και εγκλωβισμών αερίου.

Με την αύξηση της συχνότητας (μεσαία συχνότητα) επιτυγχάνεται ένα τόξο πιο στενό, πιο συγκεντρωμένο και πιο σταθερό και μια μεγαλύτερη ποιότητα της συγκόλλησης κομματιών μικρού πάχους.

Συγκολλήσεις TIG του χάλυβα

Η διαδικασία TIG είναι πολύ αποτελεσματική στη συγκόλληση, τόσο του κοινού, όσο και του εμπλουτισμένου με άνθρακα χάλυβα, για το πρώτο πέρασμα σε σωλήνες και για συγκολλήσεις που απαιτούν άριστη αισθητική εμφάνιση. Απαιτείται η άμεση (κανονική) πολικότητα (D.C.S.P.).

Προετοιμασία των άκρων

Η διαδικασία απαιτεί τον προσεκτικό καθαρισμό και την προετοιμασία των άκρων.

Επιλογή και προετοιμασία του ηλεκτροδίου

Συνιστάται η χρήση ηλεκτροδίων βολφραμίου με θόριο (2% θόριο, κόκκινου χρώματος) ή εναλλακτικά ηλεκτρόδια Δημητρίου ή Λανθανίου με τις εξής διαμέτρους:

Ø ηλεκτροδίου	Εύρος ρεύματος
1.0 mm	15÷75 A
1.6 mm	60÷150 A
2.4 mm	130÷240 A

Η αιχμή του ηλεκτροδίου πρέπει να τροχίζεται όπως στην εικόνα.

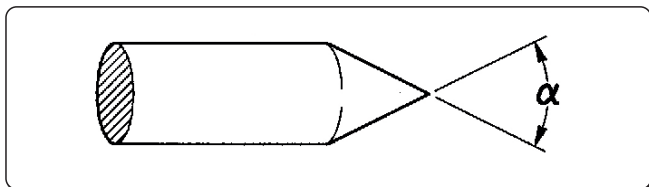

α°	Εύρος ρεύματος
30	0÷30 A
60÷90	30÷120 A
90÷120	120÷250 A

Υλικό συγκόλλησης (κόλληση)

Οι ράβδοι συγκολλητικού υλικού (κόλλησης) πρέπει να έχουν μηχανικές ιδιότητες παρόμοιες με αυτές της βάσης (κομματιού). Σας συνιστούμε να μη χρησιμοποιείτε ράβδους που προέρχονται από το υλικό της βάσης (κομματιού), γιατί μπορεί να περιέχουν ακαθαρσίες από την κατεργασία και να έχουν αρνητικές συνέπειες στη συγκόλληση.

Προστατευτικό αέριο

Σχεδόν πάντοτε χρησιμοποιείται το καθαρό Αργό (99,99%).

Ρεύμα συγκόλλησης	Ø ηλεκτροδίου	Ακροφύσιο αερίου αριθ	Ακροφύσιο αερίου	Ροή αργού
30 A	0÷30 mm	4/5	6/8.0 mm	5-6 l/min
60÷90 A	30÷120 mm	4/5/6	6.5/8.0/9.5 mm	6-7 l/min
90÷120 A	120÷250 mm	6/7	9.5/11.0 mm	7-8 l/min

Συγκόλληση TIG του χαλκού

Η διαδικασία TIG προβλέπει υψηλή θερμική ισχύ και είναι ιδιαίτερα ενδεδειγμένη για τη συγκόλληση υλικών υψηλής θερμικής αγωγιμότητας, όπως ο χαλκός.

Για τη συγκόλληση TIG του χαλκού, ακολουθήστε τις οδηγίες για τη συγκόλληση TIG του χάλυβα ή ειδικών εγχειριδίων.

9.3 Συγκόλλησης με συνεχές συρμα (mig/mag)

Εισαγωγή

Ένα σύστημα MIG αποτελείται από μια γεννήτρια συνεχούς ρεύματος, έναν τροφοδότη και ένα καρούλι σύρματος, μια τσιμπίδα και το αέριο

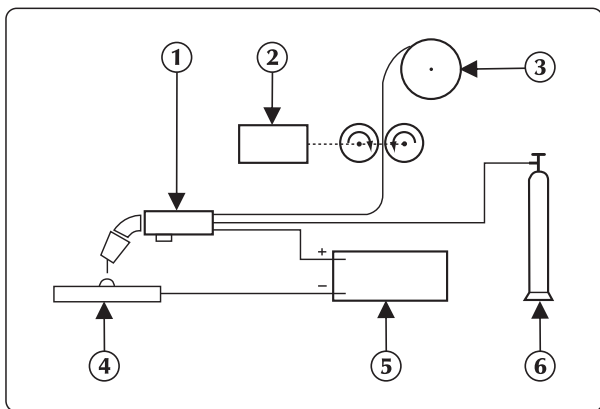

Διάταξη χειροκίνητης συγκόλλησης

Το ρεύμα μεταφέρεται στο τόξο μέσω του τηκόμενου ηλεκτροδίου (σύρμα με θετική πολικότητα); Στη διαδικασία αυτή το λειωμένο μέταλλο μεταφέρεται πάνω στο συγκολλούμενο κομμάτι, με τη βοήθεια του τόξου. Η τροφοδοσία του σύρματος είναι απαραίτητη για την αποκατάσταση του λειωμένου συγκολλητικού κατά τη συγκόλληση.

Μέθοδοι εργασίας

Στη συγκόλληση με προστασία αερίου, ο τρόπος σύμφωνα με τον οποίο οι σταγόνες αποκολλώνται από το ηλεκτρόδιο καθορίζει τα δύο συστήματα μεταφοράς.

Η πρώτη μέθοδος που ονομάζεται “ΜΕΤΑΦΟΡΑ ΜΕ ΒΡΑΧΥΚΥΚΛΩΜΑ (SHORT-ARC)”, φέρνει σε άμεση επαφή το ηλεκτρόδιο με το λουτρό. Δημιουργείται ένα βραχυκύκλωμα, που έχει ως αποτέλεσμα το λιώσιμο και την κοπή του σύρματος. Μετά από αυτό, το τόξο ανάβει ξανά και ο κύκλος επαναλαμβάνεται.

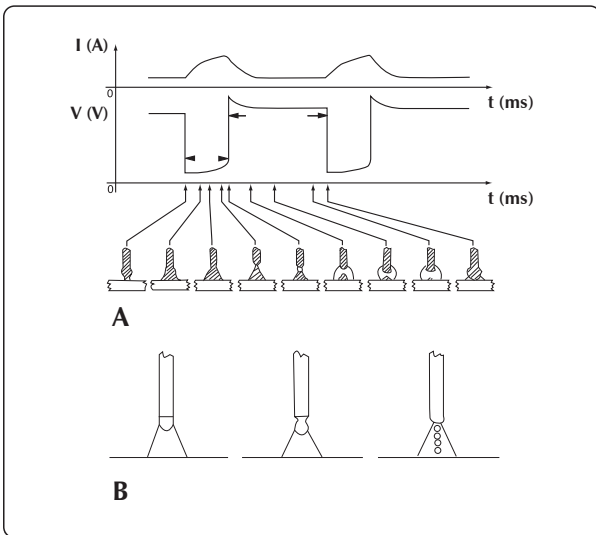

Κύκλος SHORT και συγκόλληση SPRAY ARC

Μια άλλη μέθοδος για να πετύχουμε τη μεταφορά των σταγόνων είναι η επωνομαζόμενη “ΜΕΤΑΦΟΡΑ ΜΕ ΨΕΚΑΣΜΟ (SPRAY-ARC)”, που επιτρέπει στις σταγόνες να αποκολληθούν από το ηλεκτρόδιο και, σε δεύτερο χρόνο, να φτάσουν στο λουτρό συγκόλλησης.

Παράμετροι συγκόλλησης



Η ορατότητα του τόξου μειώνει την ανάγκη της απόλυτης τήρησης των πινάκων ρύθμισης, εκ μέρους του χειριστή, ο οποίος έχει τη δυνατότητα να ελέγχει άμεσα το λουτρό τήξης.

- Η τάση επηρεάζει άμεσα τη μορφή της ραφής, αλλά οι διαστάσεις της συγκολλημένης επιφάνειας μπορεί να ποικίλουν ανάλογα με τις απαιτήσεις, ρυθμίζοντας με το χέρι την κίνηση της τσιμπίδας, έτσι ώστε να εναποτίθενται μεταβλητές ποσότητες υλικού, με σταθερή όμως τάση.
- Η ταχύτητα προώθησης του σύρματος είναι σε συνάρτηση την τιμή του ρεύματος συγκόλλησης.

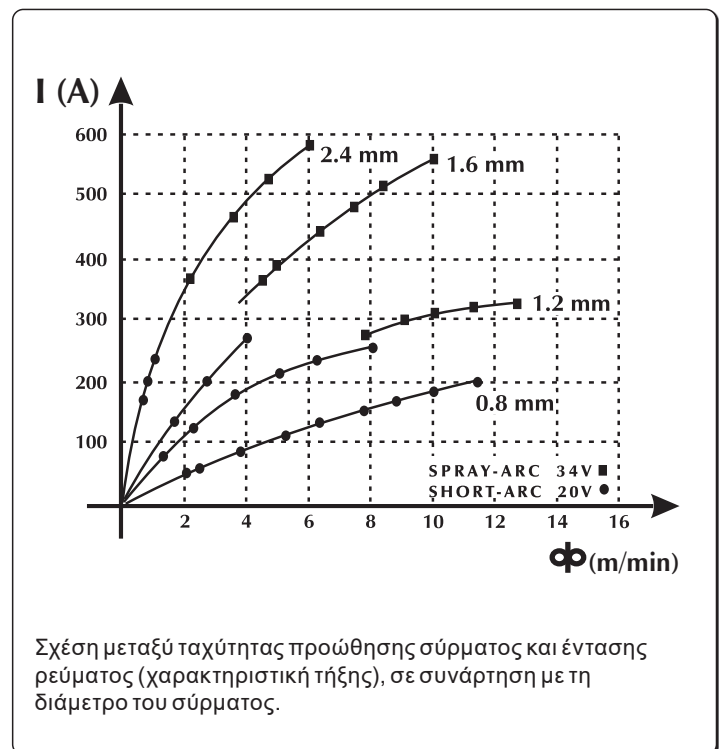
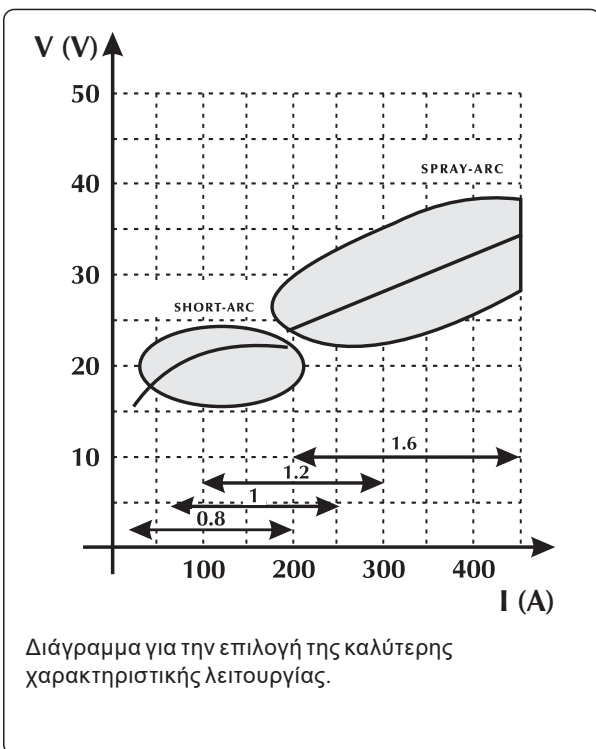
Na nasledujících dvoch obrázkoch sú zobrazené vzťahy medzi jednotlivými parametrami zvárania.

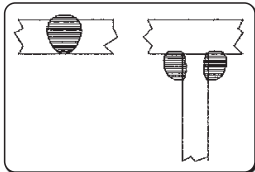
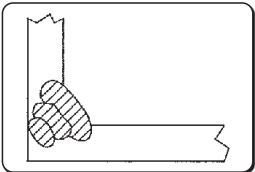
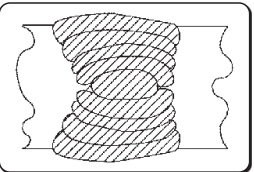

Βοηθητικός πίνακας για την επιλογή των παραμετρών συγκόλλησης, με αναφορά στις πιο τυπικές εφαρμογές και στα συρματα που χρησιμοποιούνται πιο συχνά

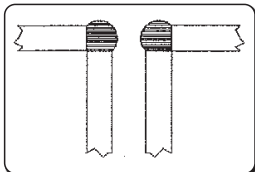
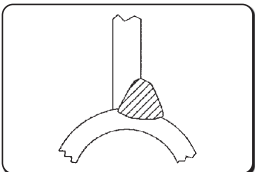
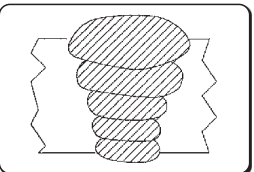
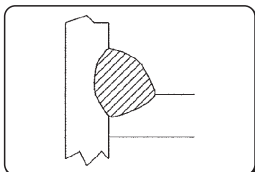
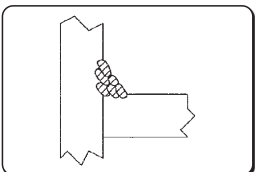
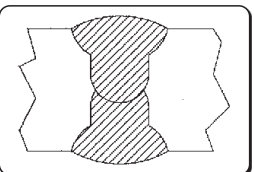
Τάση τόξου	Ø 0,8 mm	Ø 1,0-1,2 mm	Ø 1,6 mm	Ø 2,4 mm
16V - 22V SHORT - ARC				
	60 - 160 A Χαμηλή διείσδυση για μικρό πάχος	100 - 175 A Καλός έλεγχος της διείσδυσης και της τήξης	120 - 180 A Καλή τήξη σε οριζόντιο και κατακόρυφο επίπεδο	150 - 200 A Δεν χρησιμοποιείται
	<hr/>			
	24V - 28V SEMI SHORT-ARC (Μεταβατική ζώνη)			
150 - 250 A Αυτόματη γωνιακή συγκόλληση		200 - 300 A Αυτόματη συγκόλληση με υψηλή τάση	250 - 350 A Αυτόματη κατεβατή συγκόλληση	300 - 400 A Δεν χρησιμοποιείται
<hr/>				
30V - 45V SPRAY - ARC				
	150 - 250 A Χαμηλή διείσδυση με ρύθμιση στα 200 A	200 - 350 A Αυτόματη συγκόλληση με πολλαπλά περάσματα	300 - 500 A Καλή διείσδυση σε κατεβατή	500 - 750 A Καλή διείσδυση, υψηλή εναπόθεση σε μεγάλο πάχος

Αέρια που χρησιμοποιούνται

Η συγκόλληση MIG-MAG χαρακτηρίζεται κυρίως από τον τύπο του αερίου που χρησιμοποιείται: αδρανές για τη συγκόλληση MIG (Metal Inert Gas), ενεργό για τη συγκόλληση MAG (Metal Active Gas).

- Διοξείδιο του άνθρακα (CO₂)

Χρησιμοποιώντας CO₂ σαν προστατευτικό αέριο επιτυγχάνονται υψηλές επιδόσεις, με μεγάλη ταχύτητα προώθησης και καλές μηχανικές ιδιότητες, σε συνδυασμό με το χαμηλό κόστος λειτουργίας. Παρόλα αυτά, η χρήση αυτού του αερίου δημιουργεί σημαντικά προβλήματα στην τελική χημική σύνθεση των αρμών, επειδή υπάρχει μια απώλεια στοιχείων που οξειδώνονται εύκολα και, ταυτόχρονα, έχουμε τον εμπλουτισμό του τήγματος με άνθρακα. Η συγκόλληση με καθαρό CO₂ παρουσιάζει και άλλους τύπους προβλημάτων, όπως υπερβολική παρουσία πιτσιλισμάτων και οι πόροι από οξείδιο του άνθρακα.

- Αργό

Αυτό το αδρανές αέριο χρησιμοποιείται καθαρό στη συγκόλληση των ελαφρών κραμάτων, ενώ, για τη συγκόλληση του ανοξειδωτού χάλυβα με χρώμιο-νικέλιο, προτιμάται η προσθήκη οξυγόνου και CO₂ σε ποσοστό 2%. Αυτό δίνει σταθερότητα στο τόξο και καλύτερη μορφή στη ραφή.

- Ήλιο

Αυτό το αέριο χρησιμοποιείται ως εναλλακτική λύση αντί του Αργού και επιτρέπει μεγαλύτερη διείσδυση (σε μεγάλο πάχος) και μεγαλύτερη ταχύτητα προώθησης.

- Μίγμα Αργού-Ηλίου

Επιτυγχάνεται ένα πιο σταθερό τόξο, σε σχέση με αυτό του καθαρού Ηλίου, μεγαλύτερη διείσδυση και ταχύτητα σε σχέση με το Αργό.

- Μίγμα Αργόν-CO₂ και Αργόν-CO₂-Οξυγόνο

Αυτά τα μίγματα χρησιμοποιούνται στη συγκόλληση των σιδηρούχων υλικών κυρίως σε συνθήκες SHORT-ARC, επειδή βελτιώνεται η ειδική θερμική παροχή. Αυτό δεν αποκλείει τη χρήση του στο SPRAY-ARC.

Συνήθως το μίγμα περιέχει ένα ποσοστό CO₂ μεταξύ 8% και 20% και O₂ γύρω στο 5%.

Συμβουλευτείτε το εγχειρίδιο οδηγιών χρήσης της διάταξης.

10. ΤΕΧΝΙΚΑ ΧΑΡΑΚΤΗΡΙΣΤΙΚΑ

Ηλεκτρικά Χαρακτηριστικά			U.M.
Τάση τροφοδοσίας U1 (50/60 Hz)	3x230 (±15%)	3x400 (±15%)	Vac
Z _{max} (@PCC) *	62	62	mΩ
Ασφάλεια γραμμής με καθυστέρηση	30	20	A
Τύπος επικοινωνίας	ΨΗΦΙΑΚΟΣ	ΨΗΦΙΑΚΟΣ	
Μέγ. απορροφούμενη ισχύς	13.3	13.0	kVA
Μέγ. απορροφούμενη ισχύς	12.8	12.4	kW
Απορρόφηση ισχύος σε ανενεργή κατάσταση	71	71	W
Συντελεστής ισχύος (PF)	0.96	0.95	
Απόδοση (μ)	85	85	%
Cos φ	0.99	0.99	
Μέγιστη απορρόφηση ρεύματος I _{1max}	32.9	18.8	A
Πραγματικό ρεύμα I _{1eff}	20.8	13.3	A
Εύρος ρυθμίσεων (MMA)	3-320	3-320	A
Τάση εν κενώ U ₀	75	75	Vdc

* Αυτή η συσκευή πληροί τις απαιτήσεις του προτύπου EN / IEC 61000-3-11.

* Αυτή η συσκευή πληροί τις απαιτήσεις του προτύπου EN / IEC 61000-3-12, αν η μέγιστη επιτρεπόμενη εμπέδηση δικτύου στο σημείο διεπαφής με το δημόσιο δίκτυο (σημείο Κοινής σύνδεσης, ΣΚΣ - point of common coupling, PCC) είναι χαμηλότερη ή ίση με την αναφερόμενη τιμή "Z_{max}". Αν η συσκευή είναι συνδεδεμένη στο δημόσιο δίκτυο παροχής χαμηλής τάσης, ο εγκαταστάτης ή ο χρήστης έχουν την υποχρέωση να εξακριβώσουν (συμβουλευόμενοι ενδεχομένως τον διαχειριστή του ηλεκτρικού δικτύου) αν η συσκευή μπορεί να συνδεθεί.

Συντελεστής χρήσης	3x230V	3x400V	U.M.
Συντελεστής χρήσης MMA (40°C)			
(X=35%)	320	-	A
(X=50%)	-	320	A
(X=60%)	270	300	A
(X=100%)	230	250	A
Συντελεστής χρήσης MMA (25°C)			
(X=60%)	320	320	A
(X=100%)	270	270	A
Συντελεστής χρήσης TIG (40°C)			
(X=45%)	320	-	A
(X=60%)	300	320	A
(X=100%)	250	270	A
Συντελεστής χρήσης TIG (25°C)			
(X=70%)	320	320	A
(X=100%)	270	270	A
Συντελεστής χρήσης MIG/MAG (40°C)			
(X=35%)	320	-	A
(X=50%)	-	320	A
(X=60%)	280	310	A
(X=100%)	230	250	A
Συντελεστής χρήσης MIG/MAG (25°C)			
(X=60%)	320	-	A
(X=70%)	-	320	A
(X=100%)	270	270	A

Φυσικά χαρακτηριστικά			U.M.
Βαθμός προστασίας IP	IP23S		
Κλάση μόνωσης	H		
Διαστάσεις (ΠxBxΥ)	620x240x460		mm
Βάρος	26.7		Kg
Πρότυπα κατασκευής	EN IEC 60974-1/A1:2019 EN IEC 60974-3:2019 EN 60974-10/A1:2015		
Παράγραφο καλώδιο τροφοδοσίας	4x4		mm ²
Μήκος καλωδίου τροφοδοσίας	5		m

11. ΠΙΝΑΚΙΔΑ ΧΑΡΑΚΤΗΡΙΣΤΙΚΩΝ

VOESTALPINE BÖHLER WELDING SELCO S.R.L. Via Palladio, 19 - ONARA (PADOVA) - ITALY			
URANOS NX 3200 PME		N°	
EN IEC 60974-1/A1:2019 60974-10/A1:2015 Class A			
3A/20.0V - 320A (320A)/32.8V (32.8V)			
X (40°C)			
50% (35%)			
60%			
100%			
S	U ₀	I _z	I _z
	75V	320A (320A)	300A (270A)
S	U ₂	I _z	I _z
		32.8V (32.8V)	32.0V (30.8V)
S	U ₂	I _z	I _z
		30.0V (29.2V)	30.0V (29.2V)
3A/10.0V - 320A (320A)/22.8V (22.8V)			
X (40°C)			
(45%)			
60%			
100%			
S	U ₀	I _z	I _z
	75V	(320A)	320A (300A)
S	U ₂	I _z	I _z
		22.8V	22.8V (22.0V)
S	U ₂	I _z	I _z
		20.8V (20.0V)	20.8V (20.0V)
3A/14.0V - 320A (320A)/30.0V (30.0V)			
X (40°C)			
50% (35%)			
60%			
100%			
S	U ₀	I _z	I _z
	75V	320A (320A)	310A (280A)
S	U ₂	I _z	I _z
		30.0V (30.0V)	29.5V (28.5V)
S	U ₂	I _z	I _z
		26.5V (25.5V)	26.5V (25.5V)
U ₁ 400V(230V)		I _{max} 18.8A(32.9A)	
		I _{eff} 13.3A(20.8A)	
IP 23 S		UK CA CE EAC MADE IN ITALY	

12. ΣΗΜΑΣΙΑ ΠΙΝΑΚΪΔΑΣ ΧΑΡΑΚΤΗΡΙΣΤΙΚΩΝ

1		2			
3		4			
5		6			
7	9	23			
		11			
8	10	12	15	16	17
		13	15A	16A	17A
8	10	14	15B	16B	17B
		14	15B	16B	17B
7	9	11			
		12	15	16	17
8	10	13	15A	16A	17A
		14	15B	16B	17B
18	19	20	21		
22	UK CA CE EAC MADE IN ITALY				

CE Δήλωση συμμόρφωσης ΕΕ
 EAC Δήλωση συμμόρφωσης ΕΑC
 UKCA Δήλωση συμμόρφωσης UKCA

- Σήμα κατασκευαστή
- Επωνυμία και διεύθυνση κατασκευαστή
- Μοντέλο συσκευής
- Αριθ. σειράς
 ΧΧΧΧΧΧΧΧΧΧΧΧ Έτος κατασκευής
- Σύμβολο τύπου μηχανής συγκόλλησης
- Παραπομπή στα πρότυπα κατασκευής
- Σύμβολο διαδικασίας συγκόλλησης
- Σύμβολο μηχανών συγκόλλησης για λειτουργία σε περιβάλλον με αυξημένο κίνδυνο ηλεκτροπληξίας
- Σύμβολο ρεύματος συγκόλλησης
- Ονομαστική τάση χωρίς φορτίο
- Εύρος μέγιστου και ελάχιστου ονομαστικού ρεύματος συγκόλλησης και αντίστοιχης συμβατικής τάσης φόρτωσης
- Σύμβολο κύκλου διακοπτόμενης λειτουργίας
- Σύμβολο ονομαστικού ρεύματος συγκόλλησης
- Σύμβολο ονομαστικής τάσης συγκόλλησης
- Τιμές κύκλου διακοπτόμενης λειτουργίας
- Τιμές κύκλου διακοπτόμενης λειτουργίας
- Τιμές κύκλου διακοπτόμενης λειτουργίας
- Τιμές ονομαστικού ρεύματος συγκόλλησης
- Τιμές ονομαστικού ρεύματος συγκόλλησης
- Τιμές ονομαστικού ρεύματος συγκόλλησης
- Τιμές συμβατικής τάσης φόρτωσης
- Τιμές συμβατικής τάσης φόρτωσης
- Τιμές συμβατικής τάσης φόρτωσης
- Σύμβολο τροφοδοσίας
- Ονομαστική τάση τροφοδοσίας
- Μέγιστο ονομαστικό ρεύμα τροφοδοσίας
- Μέγιστο αποτελεσματικό ρεύμα τροφοδοσίας
- Βαθμός προστασίας
- Ονομαστική τάση αιχμής

13. SCHEMA, DIAGRAM, SCHALTPLAN, SCHÉMA, ESQUEMA, DIAGRAMA, SCHEMA, KOPPLINGSSCHEMA, OVERSICHT, SKJEMA, KYTKENTÄKAAVIO, ΔΙΑΓΡΑΜΜΑ

URANOS NX 3200 PME 3x230V 3x400V LCD 3.5" (55.03.070)

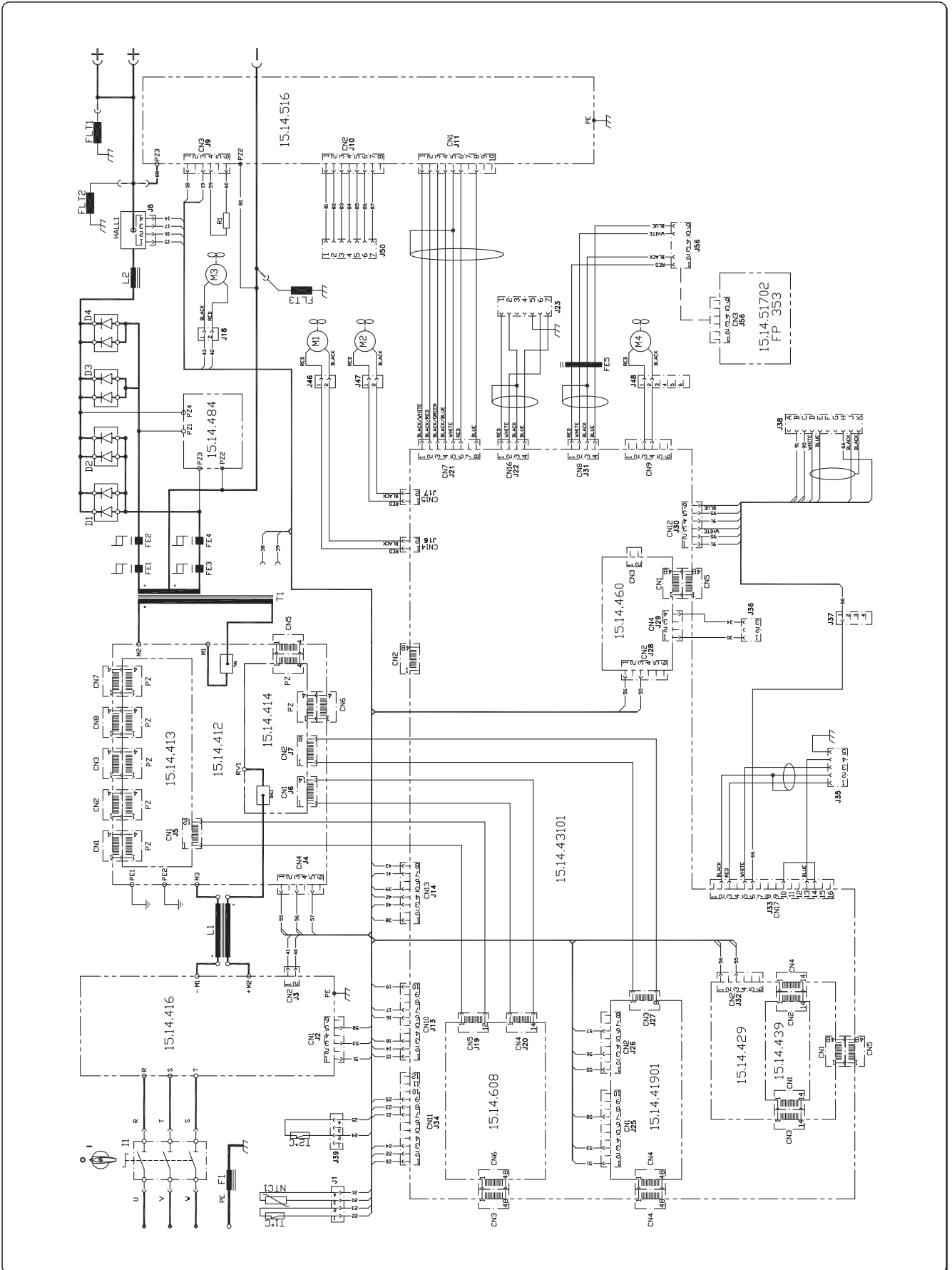

URANOS NX 3200 PME 3x230V 3x400V (55.03.066)

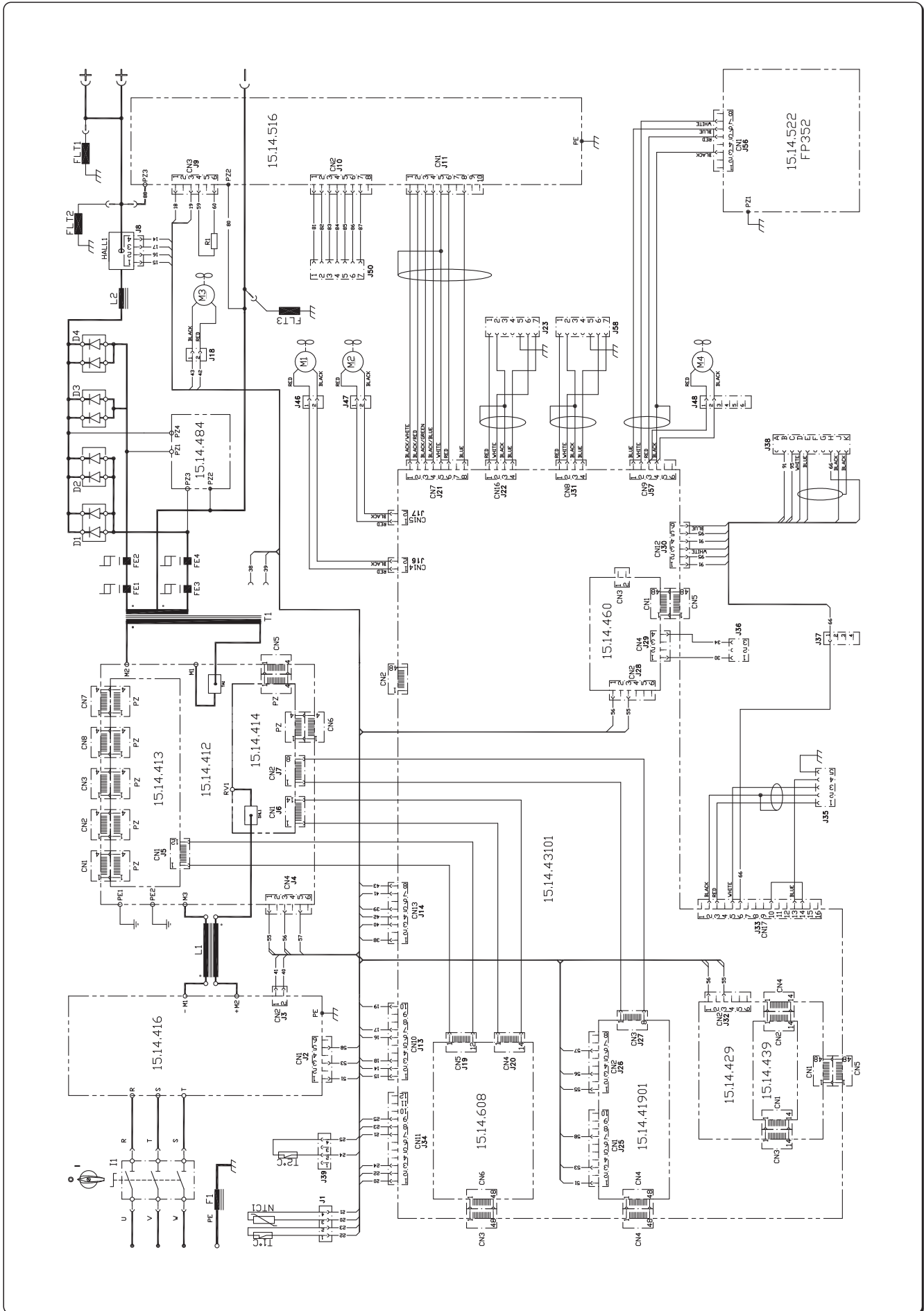

14. CONNETTORI, CONNECTORS, VERBINDER, CONNECTEURS, CONECTORES, CONECTORES, VERBINDINGEN, KONTAKTDON, KONNEKTORER, SKJØTEMUNNSTYKKER, LIITTIMET, ΣΥΝΔΕΤΗΡΕΣ

URANOS NX 3200 PME 3x230V 3x400V LCD 3.5" (55.03.070)

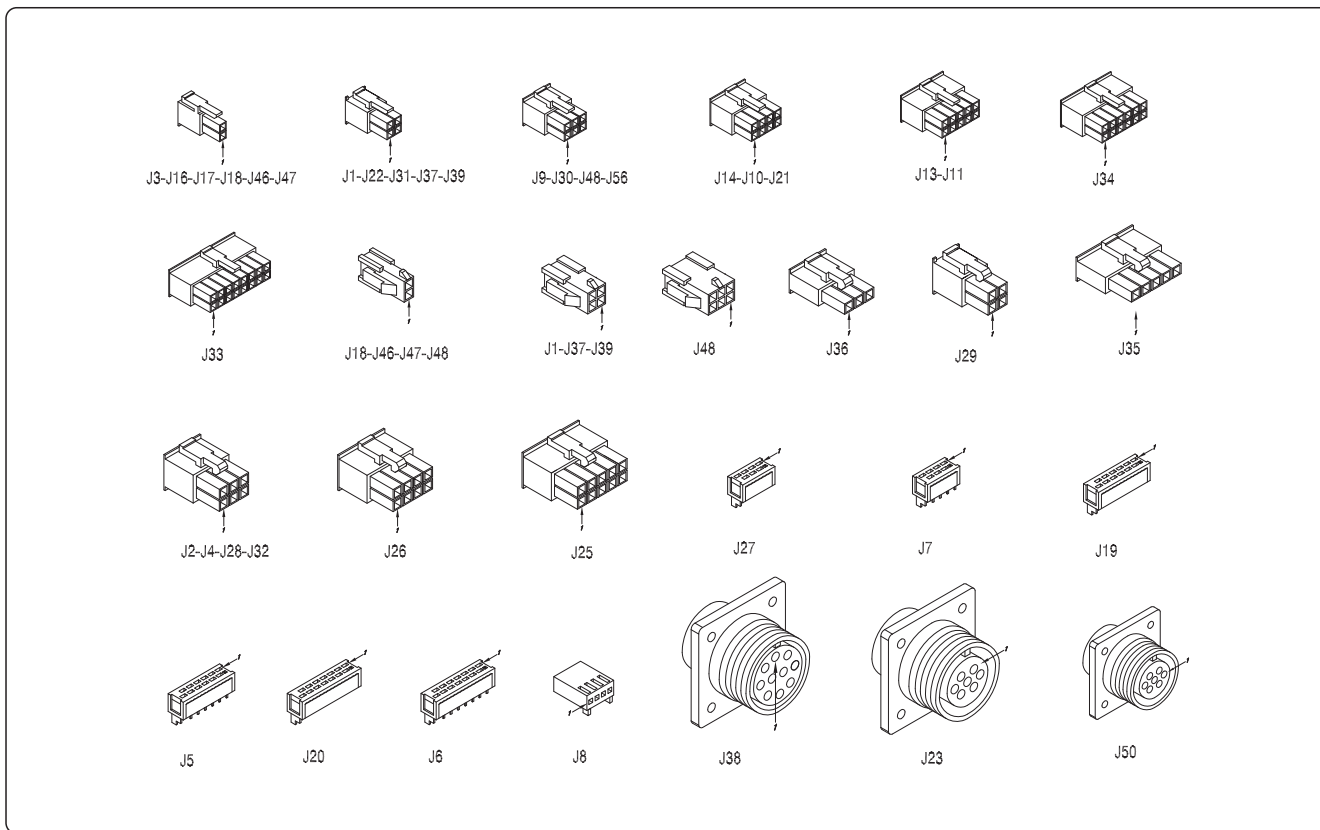

URANOS NX 3200 PME 3x230V 3x400V (55.03.066)

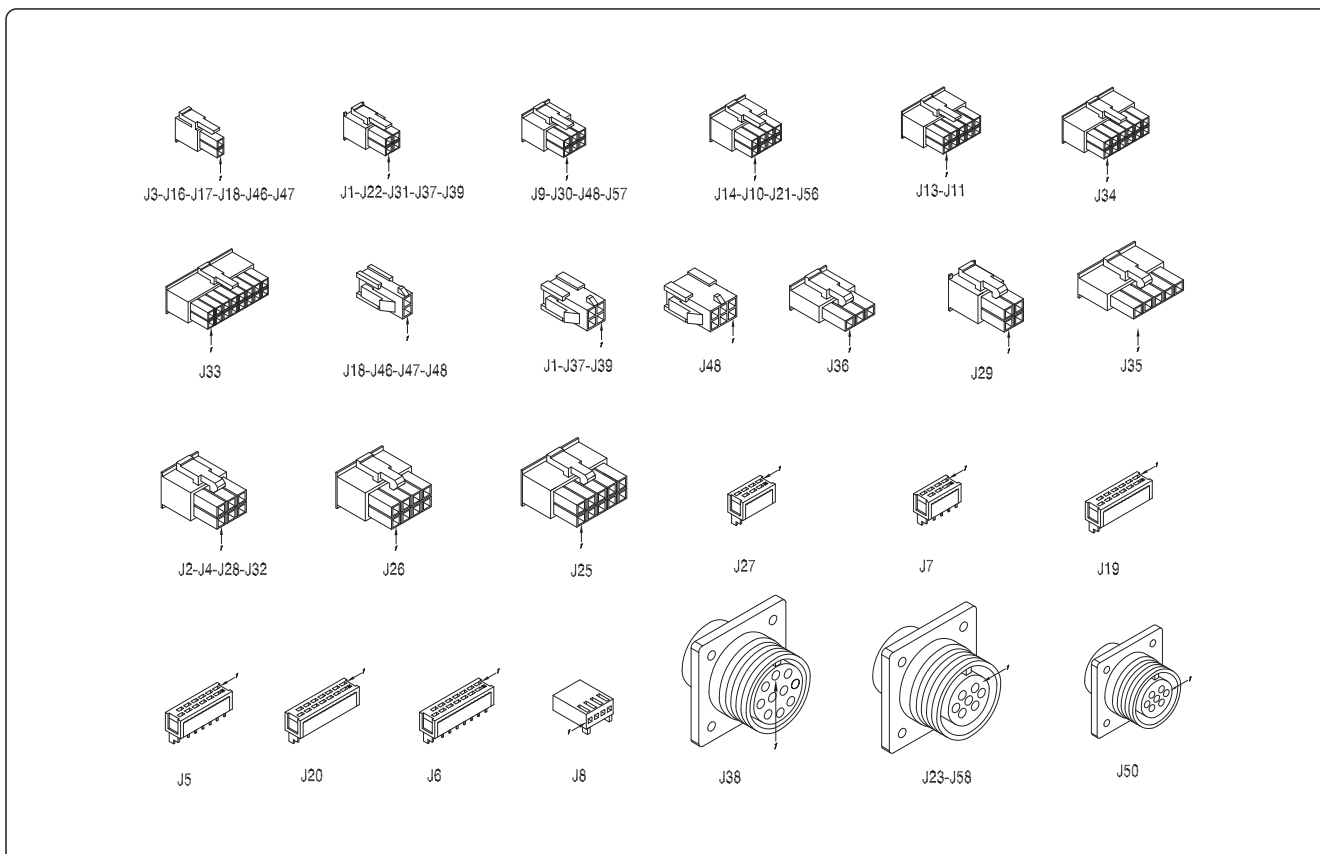

POS.	CODE	ITALIANO	ENGLISH	DEUTSCH	FRANÇAIS	ESPAÑOL
1	01.02.03802	Cofano superiore	Metal cover upper	Oberes gehäuse	Carter supérieur	Chapa superior
2	01.02.03902	Cofano inferiore	Metal cover lower	Unteres gehäuse	Carter inférieur	Chapa inferior
3	01.03.06402	Pannello laterale DX	Side panel - RIGHT	Seitenpaneel - RE	Panneau latéral droit	Panel lateral derecho
4	03.07.603	Pannello laterale SX	Side panel - LEFT	Seitenpaneel - LI	Panneau latéral gauche	Panel lateralizado.
5	01.06.02707	Coperchio	Cover	Abdeckung	Couverture	Cubierta
6	01.04.02301	Cornice plastica frontale	Front frame (plastic)	Plastikrahmen, vorne	Encadrement plastique frontal	Marco plástico frente
7	01.04.02501	Tassello plastico frontale	Front grid (plastic)	Vorderer plastikdübel	Cheville plastique frontale	Taco plástico frontal
8	01.05.02801	Cornice plastica posteriore	Rear frame (plastic)	Plastikrahmen, hinten	Encadrement plastique arrière	Marco plástico posterior
9	01.05.02901	Tassello plastico posteriore	Rear grid (plastic)	Hinterer plastikdübel	Cheville plastique arrière	Taco plástico posterior
10	03.05.13501	Profilo prese	Profile	Profil	Profil	Perfil
11	10.13.023	Presa fissa 70-95mm ²	Current socket (panel) 70-95mm ²	Feste steckdose 70-95mm ²	Prise fixe 70-95 mm ²	Base conector 70-95mm ²
12	03.05.049	Targa posteriore	Rear nameplate	Hinterschild	Plaque arrière	Placa posterior
13	20.07.16901	Supporto prese	Current socket holder	Steckdosenhalterung	Support prises	Soporte toma eléctrica
14	74.90.074	Kit manico	Handle - Spare kit	Kit griffhal	Kit manche	Kit mango
15	10.13.020	Presa fissa 50-70mm ²	Current socket (panel) - 50-70mm ²	Feste steckdose 50-70mm ²	Prise fixe 50-70 mm ²	Base conector 50-70mm ²
16	15.22.352	Pannello comandi FP352	Control panel FP352	Bedienungsfeld FP352	Panneau commandes FP352	Panel mandos FP352
17	15.18.037	Kit scheda potenza	Power P.C. Board - Spare kit	Kit leistungskarte	Kit carte puissance	Kit tarjeta de potencia
18	15.14.6082	Scheda elettronica	P.C. Board	Elektronische platine	Platine électronique	Tarjeta electrónica
19	15.14.4163	Scheda elettronica	P.C. Board	Elektronische platine	Platine électronique	Tarjeta electrónica
20	15.14.41971	Scheda elettronica	P.C. Board	Elektronische platine	Platine électronique	Tarjeta electrónica
21	15.14.5163	Scheda elettronica	P.C. Board	Elektronische platine	Platine électronique	Tarjeta electrónica
22	15.14.4842	Scheda elettronica	P.C. Board	Elektronische platine	Platine électronique	Tarjeta electrónica
23	15.14.4608	Scheda elettronica	P.C. Board	Elektronische platine	Platine électronique	Tarjeta electrónica
24	15.18.03303	Kit scheda elettronica	P.C. Board - Spare kit	Platinensatz	Kit platines	Kit tarjetas
25	09.01.011	Interruttore tripolare	Switch - 3 poles	Dreipoliger schalter	Interrupteur tripolaire	Interruptor tripolar
26	05.04.020	Induttanza livellamento	Output choke	Induktanz	Inductance de sortie	Inductancia de salida
27	05.02.033	Trasformatore inverter	Power transformer	Invertertransformator	Transformateur onduleur	Transformador inverter
28	14.70.009	Ventilatore	Fan	Ventilator	Ventilateur	Ventilador
29	14.70.050	Ventilatore	Fan	Ventilator	Ventilateur	Ventilador

POS.	CODE	ITALIANO	ENGLISH	DEUTSCH	FRANÇAIS	ESPAÑOL
30	05.18.007	Induttanza	Choke	Induktanz	Inductance	Inductancia
31	11.19.017	Sensore corrente 500A	Current sensor - 500A	Stromsensor 500A	Capteur courant 500A	Sensor corriente 500A
32	14.70.058	Ventilatore	Fan	Ventilator	Ventilateur	Ventilador
*	09.07.909	Sensore termico	Thermal sensor	Wärmefühler	Capteur thermique	Sensor térmico
*	09.07.912	Sensore termico	Thermal sensor	Wärmefühler	Capteur thermique	Sensor térmico
*	14.05.098	Modulo diodi	Diode module	Diodenmodul	Module diodes	Módulo diodos
33	49.07.511	Cablaggio	Wiring	Verdrahtung	Câblage	Cableado
34	49.04.075	Cavo alimentazione	Input line cord	Speisekabel	Cable d'alimentation	Cable alimentación
*	49.03.095	Cavo potenza 70mm ²	Power cable 70mm ²	Schweisskabel 70mm ²	Câble puissance 70 mm ²	Cable potencia 70mm ²
*	49.07.397	Cablaggio	Wiring	Verdrahtung	Câblage	Cableado
*	49.07.512	Cablaggio	Wiring	Verdrahtung	Câblage	Cableado
35	09.11.135	Manopola	Knob	Drehknopf	Bouton	Empuñadura
36	10.01.155	Tappo connettore	Screw cap	Verbinderstopfen	Bouchon connecteur	Tapón conector
37	09.11.009	Manopola	Knob	Drehknopf	Bouton	Empuñadura
38	08.22.013	Controdado	Blocking nut	Kontermutter	Contre-écrou	Contratuercia
39	08.22.012	Pressacavo	Cable clamp	Kabelklemme	Serre-câble	Racor para cable
40	20.04.061	Tappo	Cap	Stopfen	Bouchon	Tapón
	91.08.462	Manuale istruzioni: URANOS NX 3200 PME [IT, EN, DE, FR, ES, PT, NL, SV, DA, NO, FI, EL]	Instruction manual: URANOS NX 3200 PME [IT, EN, DE, FR, ES, PT, NL, SV, DA, NO, FI, EL]	Bedienungsanweisungen: URANOS NX 3200 PME [IT, EN, DE, FR, ES, PT, NL, SV, DA, NO, FI, EL]	Manuel d'instructions: URANOS NX 3200 PME [IT, EN, DE, FR, ES, PT, NL, SV, DA, NO, FI, EL]	Manual instrucciones: URANOS NX 3200 PME [IT, EN, DE, FR, ES, PT, NL, SV, DA, NO, FI, EL]
	91.08.463	Manuale istruzioni: URANOS NX 3200 PME [CS, PL, RU, TR, RO, BG, SK, ET, LV, LT, HU, SL]	Instruction manual: URANOS NX 3200 PME [CS, PL, RU, TR, RO, BG, SK, ET, LV, LT, HU, SL]	Bedienungsanweisungen: URANOS NX 3200 PME [CS, PL, RU, TR, RO, BG, SK, ET, LV, LT, HU, SL]	Manuel d'instructions: URANOS NX 3200 PME [CS, PL, RU, TR, RO, BG, SK, ET, LV, LT, HU, SL]	Manual instrucciones: URANOS NX 3200 PME [CS, PL, RU, TR, RO, BG, SK, ET, LV, LT, HU, SL]

URANOS NX 3200 PME 3x230V 3x400V LCD 3.5" (55.03.070)

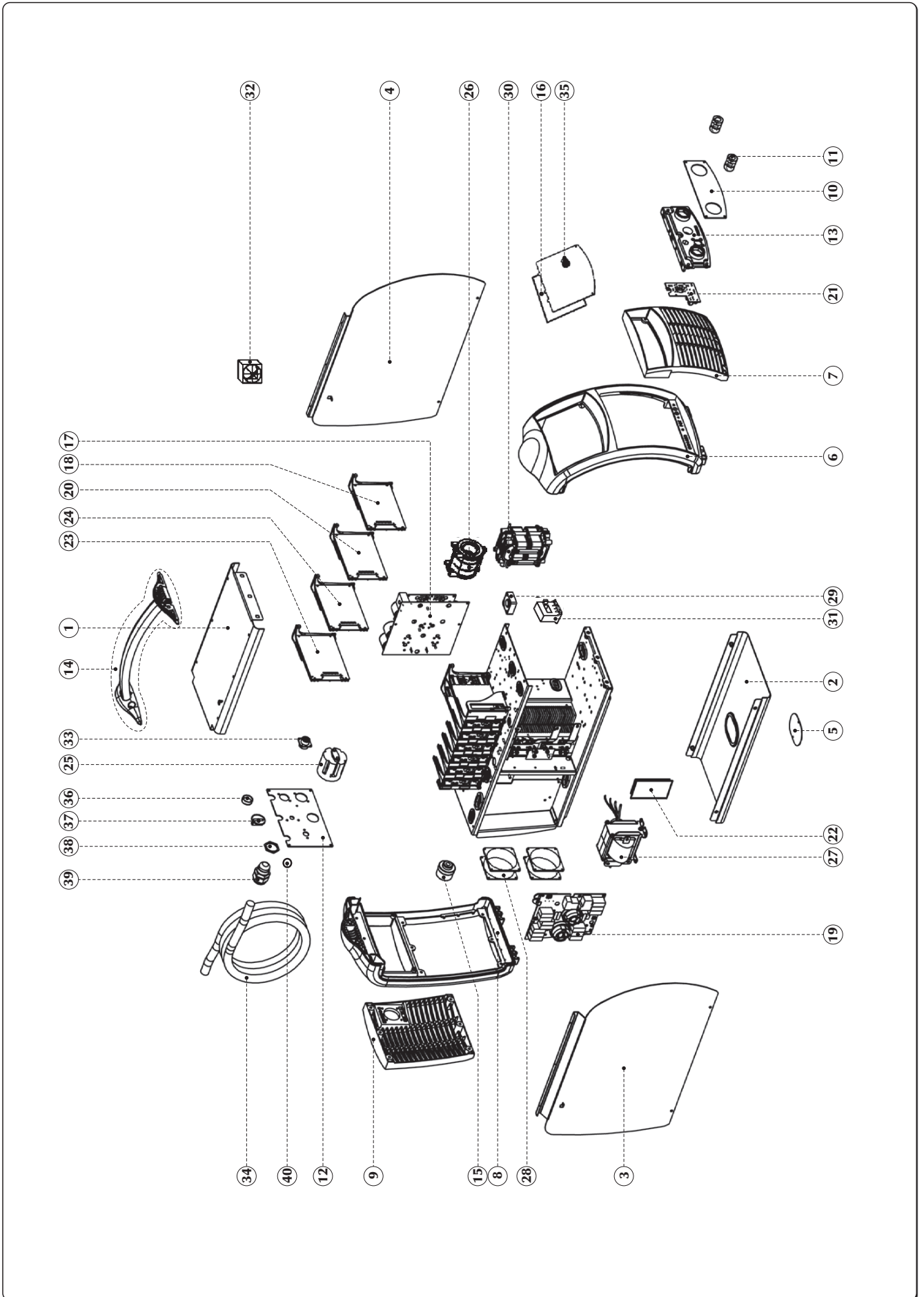

POS.	CODE	ITALIANO	ENGLISH	DEUTSCH	FRANÇAIS	ESPAÑOL
1	01.02.03802	Cofano superiore	Metal cover upper	Oberes gehäuse	Carter supérieur	Chapa superior
2	01.02.03902	Cofano inferiore	Metal cover lower	Unteres gehäuse	Carter inférieur	Chapa inferior
3	01.03.06402	Pannello laterale DX	Side panel - RIGHT	Seitenpaneel - RE	Panneau latéral droit	Panel lateral derecho
4	03.07.603	Pannello laterale SX	Side panel - LEFT	Seitenpaneel - LI	Panneau latéral gauche	Panel lateral izquierdo
5	01.06.02707	Coperchio	Cover	Abdeckung	Couverture	Cubierta
6	01.04.02301	Cornice plastica frontale	Front frame (plastic)	Plastikrahmen, vorne	Encadrement plastique frontal	Marco plástico frente
7	01.04.02501	Tassello plastico frontale	Front grid (plastic)	Vorderer plastikdübel	Cheville plastique frontale	Taco plástico frontal
8	01.05.02801	Cornice plastica posteriore	Rear frame (plastic)	Plastikrahmen, hinten	Encadrement plastique arrière	Marco plástico posterior
9	01.05.02901	Tassello plastico posteriore	Rear grid (plastic)	Hinterer plastikdübel	Cheville plastique arrière	Taco plástico posterior
10	03.05.13501	Profilo prese	Profile	Profil	Profil	Perfil
11	10.13.023	Presafissa 70-95mm ²	Current socket (panel) 70-95mm ²	Feste steckdose 70-95mm ²	Prise fixe 70-95 mm ²	Base conector 70-95mm ²
12	03.05.049	Targa posteriore	Rear nameplate	Hinterschild	Plaque arrière	Placa posterior
13	20.07.16901	Supporto prese	Current socket holder	Steckdosenhalterung	Support prises	Soporte toma eléctrica
14	74.90.074	Kit manico	Handle - Spare kit	Kit griffhal	Kit manche	Kit mango
15	10.13.020	Presafissa 50-70mm ²	Current socket (panel) - 50-70mm ²	Feste steckdose 50-70mm ²	Prise fixe 50-70 mm ²	Base conector 50-70mm ²
16	15.22.353	Pannello comandi FP353	Control panel FP353	Bedienungsfeld FP353	Panneau commandes FP353	Panel mandos FP353
17	15.18.037	Kit scheda potenza	Power P.C. Board - Spare kit	Kit leistungskarte	Kit carte puissance	Kit tarjeta de potencia
18	15.14.6082	Scheda elettronica	P.C. Board	Elektronische platine	Platine électronique	Tarjeta electrónica
19	15.14.4163	Scheda elettronica	P.C. Board	Elektronische platine	Platine électronique	Tarjeta electrónica
20	15.14.41971	Scheda elettronica	P.C. Board	Elektronische platine	Platine électronique	Tarjeta electrónica
21	15.14.5163	Scheda elettronica	P.C. Board	Elektronische platine	Platine électronique	Tarjeta electrónica
22	15.14.4842	Scheda elettronica	P.C. Board	Elektronische platine	Platine électronique	Tarjeta electrónica
23	15.14.4608	Scheda elettronica	P.C. Board	Elektronische platine	Platine électronique	Tarjeta electrónica
24	15.18.03303	Kit scheda elettronica	P.C. Board - Spare kit	Platinensatz	Kit platines	Kit tarjetas
25	09.01.011	Interruttore tripolare	Switch - 3 poles	Dreipoliger schalter	Interrupteur tripolaire	Interruptor tripolar
26	05.04.020	Induttanza livellamento	Output choke	Induktanz	Inductance de sortie	Inductancia de salida
27	05.02.033	Trasformatore inverter	Power transformer	Invertertransformator	Transformateur onduleur	Transformador inverter
28	14.70.009	Ventilatore	Fan	Ventilator	Ventilateur	Ventilador
29	14.70.050	Ventilatore	Fan	Ventilator	Ventilateur	Ventilador

POS.	CODE	ITALIANO	ENGLISH	DEUTSCH	FRANÇAIS	ESPAÑOL
30	05.18.007	Induttanza	Choke	Induktanz	Inductance	Inductancia
31	11.19.017	Sensore corrente 500A	Current sensor - 500A	Stromsensor 500A	Capteur courant 500A	Sensor corriente 500A
32	14.70.058	Ventilatore	Fan	Ventilator	Ventilateur	Ventilador
*	09.07.909	Sensore termico	Thermal sensor	Wärmefühler	Capteur thermique	Sensor térmico
*	09.07.912	Sensore termico	Thermal sensor	Wärmefühler	Capteur thermique	Sensor térmico
*	14.05.098	Modulo diodi	Diode module	Diodenmodul	Module diodes	Módulo diodos
33	49.07.511	Cablaggio	Wiring	Verdrahtung	Câblage	Cableado
34	49.04.075	Cavo alimentazione	Input line cord	Speisekabel	Cable d'alimentation	Cable alimentación
*	49.03.095	Cavo potenza 70mm ²	Power cable 70mm ²	Schweisskabel 70mm ²	Câble puissance 70 mm ²	Cable potencia 70mm ²
*	49.07.397	Cablaggio	Wiring	Verdrahtung	Câblage	Cableado
*	49.07.512	Cablaggio	Wiring	Verdrahtung	Câblage	Cableado
35	09.11.135	Manopola	Knob	Drehknopf	Bouton	Empuñadura
36	10.01.155	Tappo connettore	Screwcap	Verbinderstopfen	Bouchon connecteur	Tapón conector
37	09.11.009	Manopola	Knob	Drehknopf	Bouton	Empuñadura
38	08.22.073	Controdado	Blocking nut	Kontermutter	Contre-écrou	Contratuercia
39	08.22.012	Pressacavo	Cable clamp	Kabelklemme	Serre-câble	Racor para cable
40	20.04.061	Tappo	Cap	Stopfen	Bouchon	Tapón
	91.08.462	Manuale istruzioni: URANOS NX 3200 PME [IT,EN,DE,FR,ES,PT,NL,S V,DA,NO,FI,EL]	Instruction manual: URANOS NX 3200 PME [IT,EN,DE,FR,ES,PT,NL,S V,DA,NO,FI,EL]	Bedienungsanweisungen: URANOS NX 3200 PME [IT,EN,DE,FR,ES,PT,NL,R,ES,PT,NL,SV,DA,NO,FI,EL]	Manuel d'instructions: URANOS NX 3200 PME [IT,EN,DE,FR,ES,PT,NL,SV,DA,NO,FI,EL]	Manual instrucciones: URANOS NX 3200 PME [IT,EN,DE,FR,ES,PT,NL,SV,DA,NO,FI,EL]
	91.08.463	Manuale istruzioni: URANOS NX 3200 PME [CS,PL,RU,TR,RO,BG,SK,ET,LV,LT,HU,SL]	Instruction manual: URANOS NX 3200 PME [CS,PL,RU,TR,RO,BG,SK,ET,LV,LT,HU,SL]	Bedienungsanweisungen: URANOS NX 3200 PME [CS,PL,RU,TR,RO,BG,SK,ET,LV,LT,HU,SL]	Manuel d'instructions: URANOS NX 3200 PME [CS,PL,RU,TR,RO,BG,SK,ET,LV,LT,HU,SL]	Manual instrucciones: URANOS NX 3200 PME [CS,PL,RU,TR,RO,BG,SK,ET,LV,LT,HU,SL]

